



Sterile Container System & Baskets



Classic & Bio-Barrier Model



ASEL TIBBİ ALETLER SAN. VE TİC. ANONİM ŞİRKETİ
ASEL MEDICAL INSTRUMENTS INDUSTRY AND COM. INC. CO.
19 Mayıs Mah. Kahvecioğlu Sk. No:7/1 Tekkeköy / SAMSUN
Tel : 90 (362) 266 59 29 Fax : 90 (362) 266 59 39
www.aselip.com E-mail : bilgi@aselip.com

- According to the production programme ASELTECH's rights is reserved in production to improve, modify or delete the the products declared in this catalog.

- The weight information given in our catalog is approximate value.

AS - 2000-L3
2015

Copyright © ASELTECH Co., Inc
All right Reserved, Printed in Turkey



1/1 Full Size
Classic Model

Sterile Container System

Specifications Sizes	Lid (Perforated)	Lid (Perforated)	Safety Lid	Safety Lid
	Box (Non-Perforated)	Box (Perforated)	Box (Non-Perforated)	Box (Perforated)
580 X 280 X 100 mm 	CN-6010 CN-6011 CN-6012 CN-6013 CN-6014 CN-6015	CN-6040 CN-6041 CN-6042 CN-6043 CN-6044 CN-6045	CN-6150 CN-6151 CN-6152 CN-6153 CN-6154 CN-6155	CN-6180 CN-6181 CN-6182 CN-6183 CN-6184 CN-6185
580 X 280 X 135 mm 	CN-6016 CN-6017 CN-6018 CN-6019 CN-6020 CN-6021	CN-6046 CN-6047 CN-6048 CN-6049 CN-6050 CN-6051	CN-6156 CN-6157 CN-6158 CN-6159 CN-6160 CN-6161	CN-6186 CN-6187 CN-6188 CN-6189 CN-6190 CN-6191
580 X 280 X 150 mm 	CN-6022 CN-6023 CN-6024 CN-6025 CN-6026 CN-6027	CN-6052 CN-6053 CN-6054 CN-6055 CN-6056 CN-6057	CN-6162 CN-6163 CN-6164 CN-6165 CN-6166 CN-6167	CN-6192 CN-6193 CN-6194 CN-6195 CN-6196 CN-6197
580 X 280 X 200 mm 	CN-6028 CN-6029 CN-6030 CN-6031 CN-6032 CN-6033	CN-6058 CN-6059 CN-6060 CN-6061 CN-6062 CN-6063	CN-6168 CN-6169 CN-6170 CN-6171 CN-6172 CN-6173	CN-6198 CN-6199 CN-6200 CN-6201 CN-6202 CN-6203
580 X 280 X 260 mm 	CN-6034 CN-6035 CN-6036 CN-6037 CN-6038 CN-6039	CN-6064 CN-6065 CN-6066 CN-6067 CN-6068 CN-6069	CN-6174 CN-6175 CN-6176 CN-6177 CN-6178 CN-6179	CN-6204 CN-6205 CN-6206 CN-6207 CN-6208 CN-6209
Ps: All container measurements cover the outer size of the lids.				

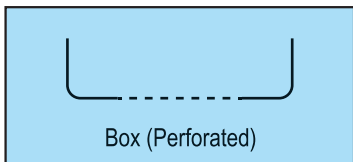

CODE	OUTSIDE	INSIDE	WEIGHT
CN-6100	595 X 275 X 95 mm	543 X 260 X 75 mm	2.15 kg
CN-6101	595 X 275 X 116 mm	543 X 260 X 96 mm	2.30 kg
CN-6102	595 X 275 X 135 mm	543 X 260 X 115 mm	2.40 kg
CN-6103	595 X 275 X 185 mm	543 X 260 X 165 mm	2.75 kg
CN-6104	595 X 275 X 243 mm	543 X 260 X 223 mm	3.25 kg

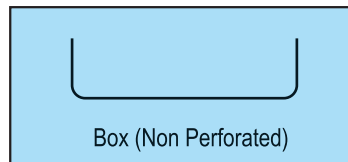

CODE	OUTSIDE	INSIDE	WEIGHT
CN-6105	595 X 275 X 95 mm	543 X 260 X 90 mm	1.70 kg
CN-6106	595 X 275 X 116 mm	543 X 260 X 111 mm	2.05 kg
CN-6107	595 X 275 X 135 mm	543 X 260 X 130 mm	2.15 kg
CN-6108	595 X 275 X 185 mm	543 X 260 X 180 mm	2.60 kg
CN-6109	595 X 275 X 243 mm	543 X 260 X 238 mm	3.10 kg



Perforated Lids



Weight: 1.35 kg

- CN-6120**
- CN-6121**
- CN-6122**
- CN-6123**
- CN-6124**
- CN-6125**

Safety Lids



Weight: 1.10 kg

- CN-6230**
- CN-6231**
- CN-6232**
- CN-6233**
- CN-6234**
- CN-6235**

Removal Lids (Non Perforated)



Weight: 1.10 kg

- CN-6130**
- CN-6131**
- CN-6132**
- CN-6133**
- CN-6134**
- CN-6135**





3/4 Quarter Size
Classic Model

Sterile Container System

Specifications Sizes	Lid (Perforated)	Lid (Perforated)	Safety Lid	Safety Lid
	Box (Non-Perforated)	Box (Perforated)	Box (Non-Perforated)	Box (Perforated)
465 X 280 X 100 mm 	CN-6240 CN-6241 CN-6242 CN-6243 CN-6244 CN-6245	CN-6260 CN-6261 CN-6262 CN-6263 CN-6264 CN-6265	CN-6350 CN-6351 CN-6352 CN-6353 CN-6354 CN-6355	CN-6370 CN-6371 CN-6372 CN-6373 CN-6374 CN-6375
465 X 280 X 135 mm 	CN-6246 CN-6247 CN-6248 CN-6249 CN-6250 CN-6251	CN-6266 CN-6267 CN-6268 CN-6269 CN-6270 CN-6271	CN-6356 CN-6357 CN-6358 CN-6359 CN-6360 CN-6361	CN-6376 CN-6377 CN-6378 CN-6379 CN-6380 CN-6381
465 X 280 X 150 mm 	CN-6252 CN-6253 CN-6254 CN-6255 CN-6256 CN-6257	CN-6272 CN-6273 CN-6274 CN-6275 CN-6276 CN-6277	CN-6362 CN-6363 CN-6364 CN-6365 CN-6366 CN-6367	CN-6382 CN-6383 CN-6384 CN-6385 CN-6386 CN-6387
Ps: All container measurements cover the outer size of the lids.				

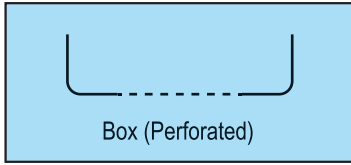

CODE	OUTSIDE	INSIDE	WEIGHT
CN-6300	475 X 275 X 95 mm	422 X 260 X 90 mm	1.65 kg
CN-6301	475 X 275 X 116 mm	422 X 260 X 96 mm	1.80 kg
CN-6302	475 X 275 X 137 mm	422 X 260 X 117 mm	1.95 kg

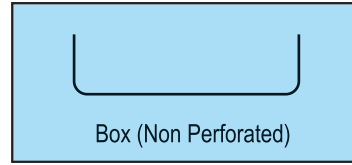

CODE	OUTSIDE	INSIDE	WEIGHT
CN-6305	475 X 275 X 95 mm	422 X 260 X 90 mm	1.50 kg
CN-6306	475 X 275 X 116 mm	422 X 260 X 111 mm	1.65 kg
CN-6307	475 X 275 X 137 mm	422 X 260 X 132 mm	1.75 kg



Perforated Lids



Weight: 0.95 kg

- CN-6340
- CN-6341
- CN-6342
- CN-6343
- CN-6344
- CN-6345

Safety Lids



Weight: 0.90 kg

- CN-6410
- CN-6411
- CN-6412
- CN-6413
- CN-6414
- CN-6415

Removal Lids (Non Perforated)



Weight: 0.85 kg

- CN-6320
- CN-6321
- CN-6322
- CN-6323
- CN-6324
- CN-6325





1/2 Half Size
Classic Model

Sterile Container System

Specifications Sizes	Lid (Perforated)	Lid (Perforated)	Safety Lid	Safety Lid
	Box (Non-Perforated)	Box (Perforated)	Box (Non-Perforated)	Box (Perforated)
285 X 280 X 100 mm 	CN-6500 CN-6501 CN-6502 CN-6503 CN-6504 CN-6505	CN-6530 CN-6531 CN-6532 CN-6533 CN-6534 CN-6535	CN-6640 CN-6641 CN-6642 CN-6643 CN-6644 CN-6645	CN-6670 CN-6671 CN-6672 CN-6673 CN-6674 CN-6675
285 X 280 X 135 mm 	CN-6506 CN-6507 CN-6508 CN-6509 CN-6510 CN-6511	CN-6536 CN-6537 CN-6538 CN-6539 CN-6540 CN-6541	CN-6646 CN-6647 CN-6648 CN-6649 CN-6650 CN-6651	CN-6676 CN-6677 CN-6678 CN-6679 CN-6680 CN-6681
285 X 280 X 150 mm 	CN-6512 CN-6513 CN-6514 CN-6515 CN-6516 CN-6517	CN-6542 CN-6543 CN-6544 CN-6545 CN-6546 CN-6547	CN-6652 CN-6653 CN-6654 CN-6655 CN-6656 CN-6657	CN-6682 CN-6683 CN-6684 CN-6685 CN-6686 CN-6687
285 X 280 X 200 mm 	CN-6518 CN-6519 CN-6520 CN-6521 CN-6522 CN-6523	CN-6548 CN-6549 CN-6550 CN-6551 CN-6552 CN-6553	CN-6658 CN-6659 CN-6660 CN-6661 CN-6662 CN-6663	CN-6688 CN-6689 CN-6690 CN-6691 CN-6692 CN-6693
285 X 280 X 260 mm 	CN-6524 CN-6525 CN-6526 CN-6527 CN-6528 CN-6529	CN-6554 CN-6555 CN-6556 CN-6557 CN-6558 CN-6559	CN-6664 CN-6665 CN-6666 CN-6667 CN-6668 CN-6669	CN-6694 CN-6695 CN-6696 CN-6697 CN-6698 CN-6699
Ps: All container measurements cover the outer size of the lids.				

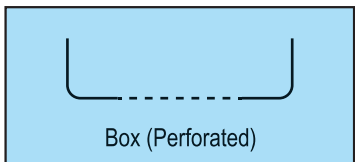

CODE	OUTSIDE	INSIDE	WEIGHT
CN-6600	306 X 272 X 95 mm	253 X 258 X 75 mm	1.25 kg
CN-6601	306 X 272 X 114 mm	253 X 258 X 94 mm	1.40 kg
CN-6602	306 X 272 X 135 mm	253 X 258 X 115 mm	1.55 kg
CN-6603	306 X 272 X 184 mm	253 X 258 X 164 mm	1.80 kg
CN-6604	306 X 272 X 241 mm	253 X 258 X 221 mm	2.10 kg

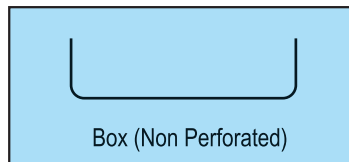

CODE	OUTSIDE	INSIDE	WEIGHT
CN-6605	306 X 272 X 95 mm	253 X 258 X 90 mm	1.15 kg
CN-6606	306 X 272 X 114 mm	253 X 258 X 109 mm	1.25 kg
CN-6607	306 X 272 X 135 mm	253 X 258 X 130 mm	1.35 kg
CN-6608	306 X 272 X 184 mm	253 X 258 X 179 mm	1.55 kg
CN-6609	306 X 272 X 241 mm	253 X 258 X 236 mm	2.00 kg



Perforated Lids

Weight: 0.70 kg

CN-6630	Grey
CN-6631	Yellow
CN-6632	Green
CN-6633	Blue
CN-6634	Red
CN-6635	Black

Safety Lids

Weight: 0.55 kg

CN-6700	Grey
CN-6701	Yellow
CN-6702	Green
CN-6703	Blue
CN-6704	Red
CN-6705	Black

Removal Lids (Non Perforated)

Weight: 0.60 kg

CN-6620	Grey
CN-6621	Yellow
CN-6622	Green
CN-6623	Blue
CN-6624	Red
CN-6625	Black











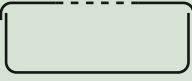

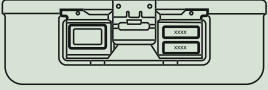



















XL Size

Classic Model

Sterile Container System

<p>Specifications</p> <p>Sizes</p>	<p>Lid (Perforated)</p>  <p>Box (Non-Perforated)</p>	<p>Lid (Perforated)</p>  <p>Box (Perforated)</p>
<p>590 X 370 X 120 mm</p> 	<p>CN-6136 </p> <p>CN-6137 </p> <p>CN-6138 </p> <p>CN-6139 </p> <p>CN-6140 </p> <p>CN-6141 </p>	<p>CN-6210 </p> <p>CN-6211 </p> <p>CN-6212 </p> <p>CN-6213 </p> <p>CN-6214 </p> <p>CN-6215 </p>
<p>590 X 370 X 180 mm</p> 	<p>CN-6142 </p> <p>CN-6143 </p> <p>CN-6144 </p> <p>CN-6145 </p> <p>CN-6146 </p> <p>CN-6147 </p>	<p>CN-6216 </p> <p>CN-6217 </p> <p>CN-6218 </p> <p>CN-6219 </p> <p>CN-6220 </p> <p>CN-6221 </p>
<p>Ps: All container measurements cover the outer size of the lids.</p>		

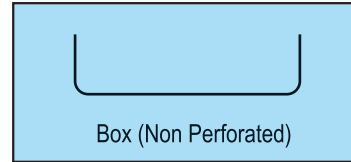
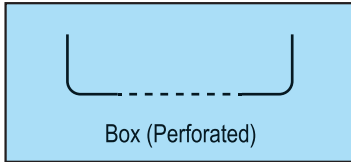

CODE	OUTSIDE	INSIDE	WEIGHT
CN-6400	595 X 365 X 105 mm	530 X 350 X 85 mm	2.50 kg
CN-6401	595 X 365 X 167 mm	530 X 350 X 145 mm	3.25 kg

CODE	OUTSIDE	INSIDE	WEIGHT
CN-6402	595 X 365 X 105 mm	543 X 350 X 100 mm	2.20 kg
CN-6403	595 X 365 X 167 mm	530 X 350 X 162 mm	3.00 kg



Perforated Lids

Weight: 1.65 kg

CN-6326	
CN-6327	
CN-6328	
CN-6329	
CN-6330	
CN-6331	



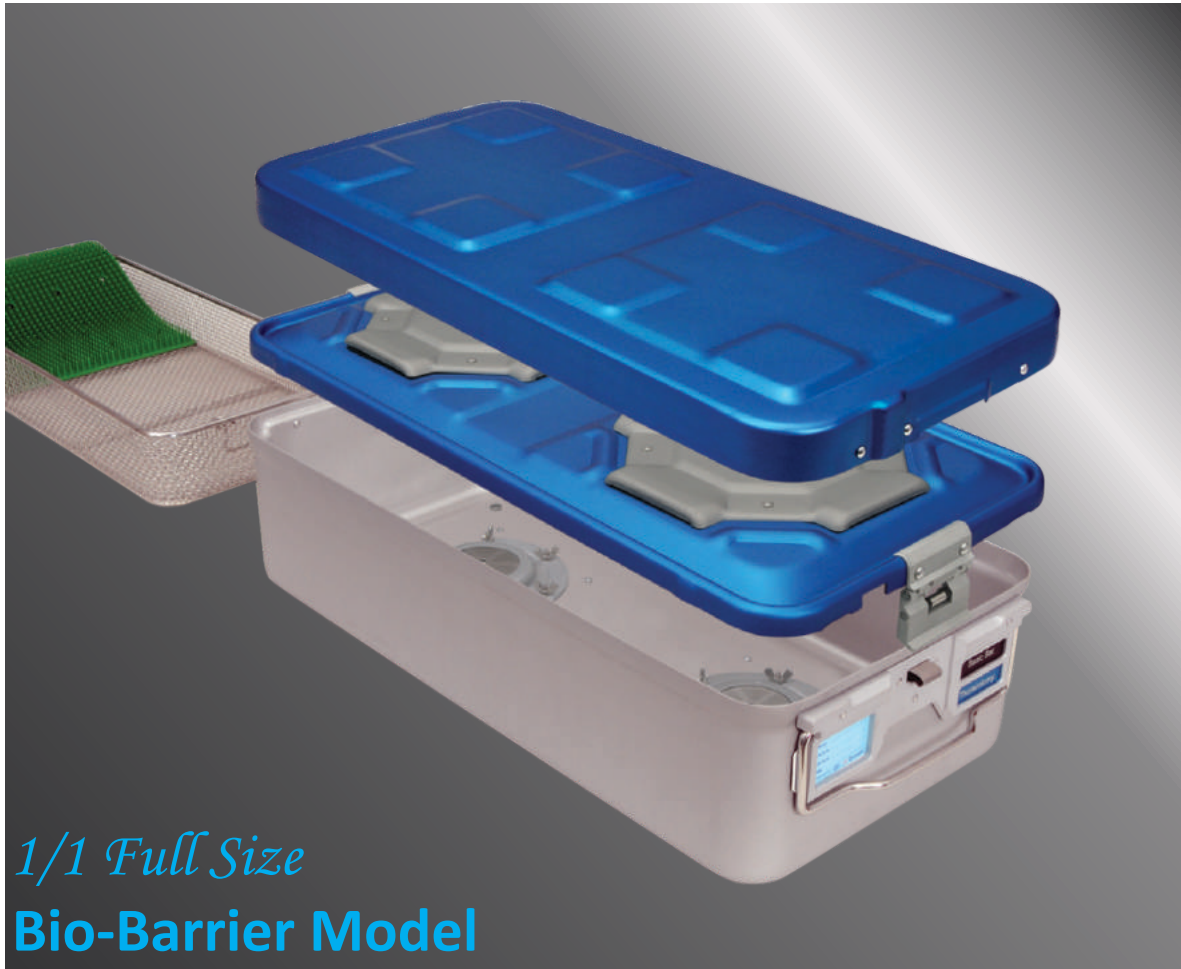

1/1 Full Size
Bio-Barrier Model

Sterile Container System

Specifications Sizes	Lid (with barrier)	Lid (with barrier)	Safety Lid Lid (with barrier)	Safety Lid Lid (with barrier)
	Box (Non-Perforated)	Box (with barrier)	Box (Non-Perforated)	Box (with barrier)
580 X 280 X h mm 	CN-7010 CN-7011 CN-7012 CN-7013 CN-7014 CN-7015	CN-7040 CN-7041 CN-7042 CN-7043 CN-7044 CN-7045	CN-7150 CN-7151 CN-7152 CN-7153 CN-7154 CN-7155	CN-7180 CN-7181 CN-7182 CN-7183 CN-7184 CN-7185
580 X 280 X h mm 	CN-7016 CN-7017 CN-7018 CN-7019 CN-7020 CN-7021	CN-7046 CN-7047 CN-7048 CN-7049 CN-7050 CN-7051	CN-7156 CN-7157 CN-7158 CN-7159 CN-7160 CN-7161	CN-7186 CN-7187 CN-7188 CN-7189 CN-7190 CN-7191
580 X 280 X h mm 	CN-7022 CN-7023 CN-7024 CN-7025 CN-7026 CN-7027	CN-7052 CN-7053 CN-7054 CN-7055 CN-7056 CN-7057	CN-7162 CN-7163 CN-7164 CN-7165 CN-7166 CN-7167	CN-7192 CN-7193 CN-7194 CN-7195 CN-7196 CN-7197
580 X 280 X h mm 	CN-7028 CN-7029 CN-7030 CN-7031 CN-7032 CN-7033	CN-7058 CN-7059 CN-7060 CN-7061 CN-7062 CN-7063	CN-7168 CN-7169 CN-7170 CN-7171 CN-7172 CN-7173	CN-7198 CN-7199 CN-7200 CN-7201 CN-7202 CN-7203
580 X 280 X h mm 	CN-7034 CN-7035 CN-7036 CN-7037 CN-7038 CN-7039	CN-7064 CN-7065 CN-7066 CN-7067 CN-7068 CN-7069	CN-7174 CN-7175 CN-7176 CN-7177 CN-7178 CN-7179	CN-7204 CN-7205 CN-7206 CN-7207 CN-7208 CN-7209

Ps: All container measurements cover the outer size of the lids.



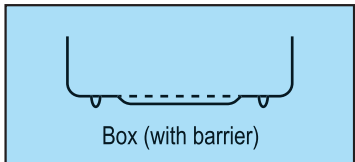

CODE	OUTSIDE	INSIDE	WEIGHT
CN-7100	595 X 275 X 115 mm	543 X 260 X 90 mm	2.70 kg
CN-7101	595 X 275 X 136 mm	543 X 260 X 111 mm	3.20 kg
CN-7102	595 X 275 X 155 mm	543 X 260 X 130 mm	3.40 kg
CN-7103	595 X 275 X 205 mm	543 X 260 X 180 mm	4.10 kg
CN-7104	595 X 275 X 263 mm	543 X 260 X 238 mm	4.90 kg

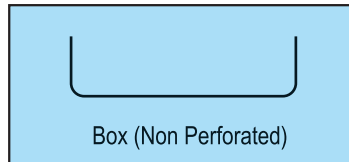

CODE	OUTSIDE	INSIDE	WEIGHT
CN-7105	595 X 275 X 95 mm	543 X 260 X 90 mm	1.70 kg
CN-7106	595 X 275 X 116 mm	543 X 260 X 111 mm	2.05 kg
CN-7107	595 X 275 X 135 mm	543 X 260 X 130 mm	2.15 kg
CN-7108	595 X 275 X 185 mm	543 X 260 X 180 mm	2.60 kg
CN-7109	595 X 275 X 243 mm	543 X 260 X 238 mm	3.10 kg



Lid Barrier system

Weight: 1.85 kg

CN-7120	
CN-7121	
CN-7122	
CN-7123	
CN-7124	
CN-7125	

Safety Lids

Weight: 1.21 kg

CN-7400	
CN-7401	
CN-7402	
CN-7403	
CN-7404	
CN-7405	





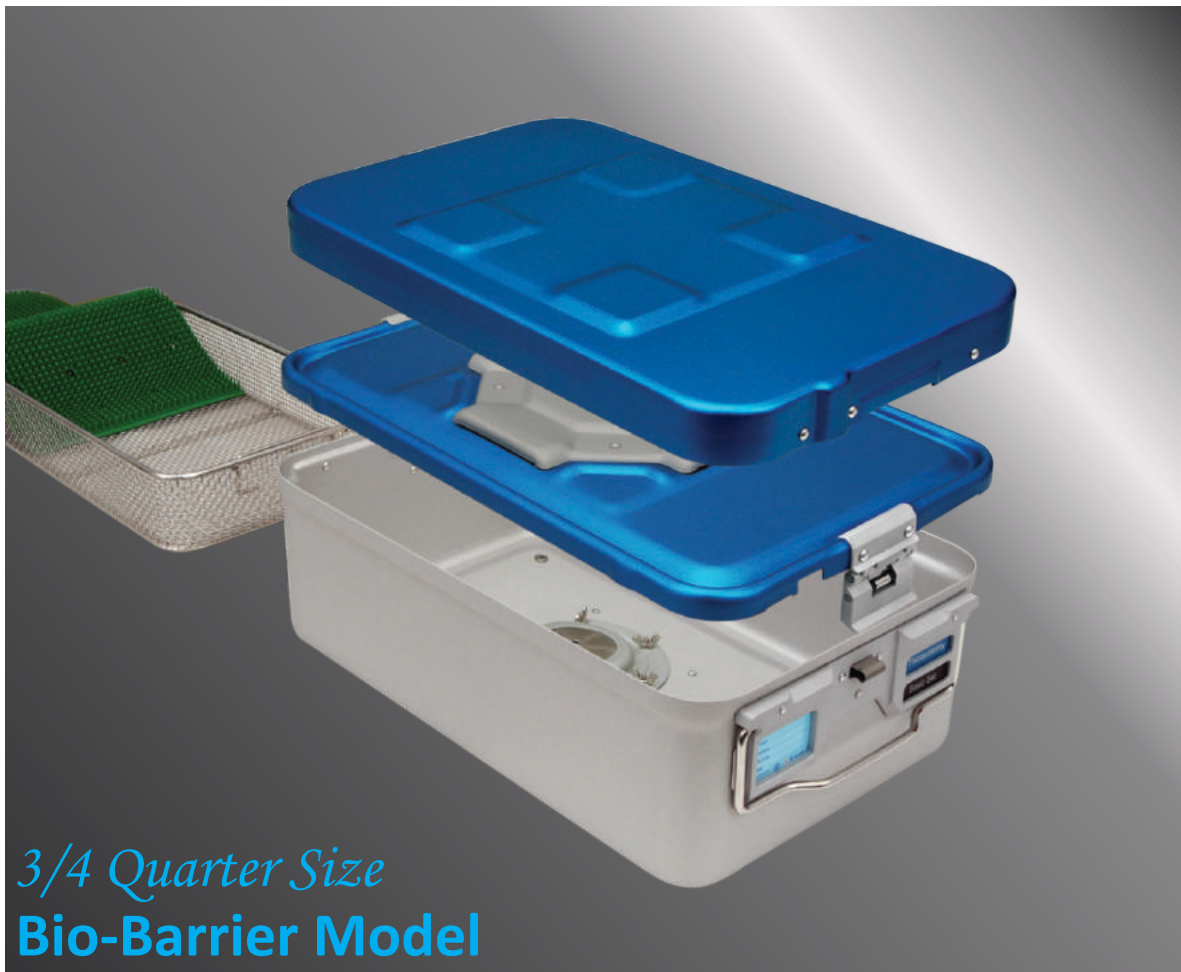





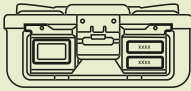

















































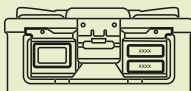























- GREY
- YELLOW
- GREEN
- BLUE
- RED
- BLACK



3/4 Quarter Size
Bio-Barrier Model

Sterile Container System

Specifications Sizes	Lid (with barrier)	Lid (with barrier)	Safety Lid Lid (with barrier)	Safety Lid Lid (with barrier)
	Box (Non-Perforated)	Box (with barrier)	Box (Non-Perforated)	Box (with barrier)
465 X 280 X h mm 	CN-7240  CN-7241  CN-7242  CN-7243  CN-7244  CN-7245 	h= 115 mm CN-7260  CN-7261  CN-7262  CN-7263  CN-7264  CN-7265 	h= 135 mm CN-7350  CN-7351  CN-7352  CN-7353  CN-7354  CN-7355 	h= 128 mm CN-7370  CN-7371  CN-7372  CN-7373  CN-7374  CN-7375 
465 X 280 X h mm 	CN-7246  CN-7247  CN-7248  CN-7249  CN-7250  CN-7251 	h= 140 mm CN-7266  CN-7267  CN-7268  CN-7269  CN-7270  CN-7271 	h= 160 mm CN-7356  CN-7357  CN-7358  CN-7359  CN-7360  CN-7361 	h= 153 mm CN-7376  CN-7377  CN-7378  CN-7379  CN-7380  CN-7381 
465 X 280 X h mm 	CN-7252  CN-7253  CN-7254  CN-7255  CN-7256  CN-7257 	h= 155 mm CN-7272  CN-7273  CN-7274  CN-7275  CN-7276  CN-7277 	h= 175 mm CN-7362  CN-7363  CN-7364  CN-7365  CN-7366  CN-7367 	h= 168 mm CN-7382  CN-7383  CN-7384  CN-7385  CN-7386  CN-7387 
Ps: All container measurements cover the outer size of the lids.				
				

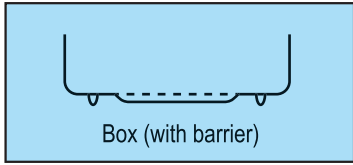

CODE	OUTSIDE	INSIDE	WEIGHT
CN-7300	475 X 275 X 115 mm	422 X 260 X 90 mm	1.95 kg
CN-7301	475 X 275 X 136 mm	422 X 260 X 111 mm	2.10 kg
CN-7302	475 X 275 X 157 mm	422 X 260 X 132 mm	2.20 kg

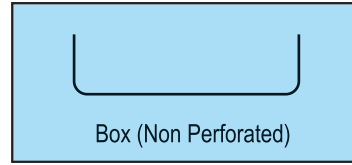

CODE	OUTSIDE	INSIDE	WEIGHT
CN-7305	475 X 275 X 95 mm	422 X 260 X 90 mm	1.50 kg
CN-7306	475 X 275 X 116 mm	422 X 260 X 111 mm	1.65 kg
CN-7307	475 X 275 X 137 mm	422 X 260 X 132 mm	1.75 kg



Lid Barrier System

Weight: 1.285 kg

CN-7340	
CN-7341	
CN-7342	
CN-7343	
CN-7344	
CN-7345	

Safety Lids

Weight: 0.94 kg

CN-7406	
CN-7407	
CN-7408	
CN-7409	
CN-7410	
CN-7411	





Sterile Container System

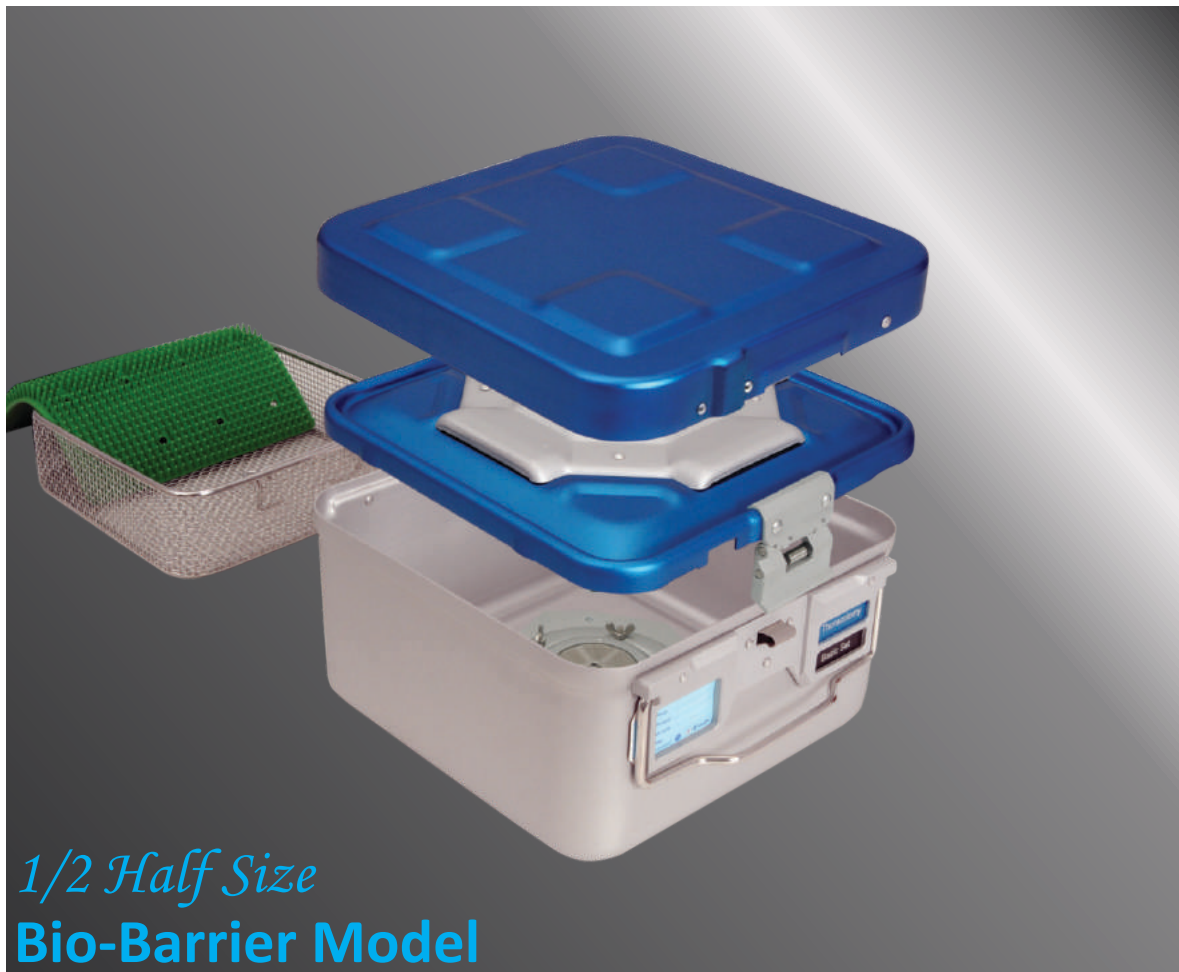

Sterile Container System

Specifications Sizes	Lid (with barrier)	Lid (with barrier)	Safety Lid Lid (with barrier)	Safety Lid Lid (with barrier)
	 Box (Non-Perforated)	 Box (with barrier)	 Box (Non-Perforated)	 Box (with barrier)
285 X 280 X h mm 	CN-7500 CN-7501 CN-7502 CN-7503 CN-7504 CN-7505 h= 105 mm	CN-7530 CN-7531 CN-7532 CN-7533 CN-7534 CN-7535 h= 135 mm	CN-7640 CN-7641 CN-7642 CN-7643 CN-7644 CN-7645 h= 128 mm	CN-7670 CN-7671 CN-7672 CN-7673 CN-7674 CN-7675 h= 145 mm
285 X 280 X h mm 	CN-7506 CN-7507 CN-7508 CN-7509 CN-7510 CN-7511 h= 140 mm	CN-7536 CN-7537 CN-7538 CN-7539 CN-7540 CN-7541 h= 160 mm	CN-7646 CN-7647 CN-7648 CN-7649 CN-7650 CN-7651 h= 153 mm	CN-7676 CN-7677 CN-7678 CN-7679 CN-7680 CN-7681 h= 170 mm
285 X 280 X h mm 	CN-7512 CN-7513 CN-7514 CN-7515 CN-7516 CN-7517 h= 155 mm	CN-7542 CN-7543 CN-7544 CN-7545 CN-7546 CN-7547 h= 175 mm	CN-7652 CN-7653 CN-7654 CN-7655 CN-7656 CN-7657 h= 168 mm	CN-7682 CN-7683 CN-7684 CN-7685 CN-7686 CN-7687 h= 185 mm
285 X 280 X h mm 	CN-7518 CN-7519 CN-7520 CN-7521 CN-7522 CN-7523 h= 205 mm	CN-7548 CN-7549 CN-7550 CN-7551 CN-7552 CN-7553 h= 235 mm	CN-7658 CN-7659 CN-7660 CN-7661 CN-7662 CN-7663 h= 218 mm	CN-7688 CN-7689 CN-7690 CN-7691 CN-7692 CN-7693 h= 245 mm
285 X 280 X h mm 	CN-4524 CN-7525 CN-7526 CN-7527 CN-7528 CN-7529 h= 265 mm	CN-7554 CN-7555 CN-7556 CN-7557 CN-7558 CN-7559 h= 295 mm	CN-7664 CN-7665 CN-7666 CN-7667 CN-7668 CN-7669 h= 278 mm	CN-7694 CN-7695 CN-7696 CN-7697 CN-7698 CN-7699 h= 305 mm
Ps: All container measurements cover the outer size of the lids.				

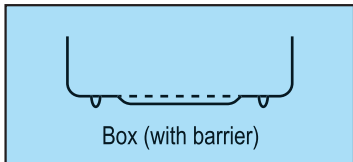

CODE	OUTSIDE	INSIDE	WEIGHT
CN-7600	3 06 X 272 X 115 mm	253 X 258 X 90 mm	1.60 kg
CN-7601	3 06 X 272 X 134 mm	253 X 258 X 109 mm	1.70 kg
CN-7602	3 06 X 272 X 155 mm	253 X 258 X 130 mm	1.80 kg
CN-7603	3 06 X 272 X 204 mm	253 X 258 X 179 mm	2.00 kg
CN-7604	3 06 X 272 X 261 mm	253 X 258 X 236 mm	2.45 kg

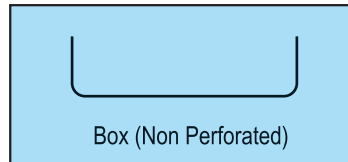

CODE	OUTSIDE	INSIDE	WEIGHT
CN-7605	306 X 272 X 95 mm	253 X 258 X 90 mm	1.15 kg
CN-7606	306 X 272 X 114 mm	253 X 258 X 109 mm	1.25 kg
CN-7607	306 X 272 X 135 mm	253 X 258 X 130 mm	1.35 kg
CN-7608	306 X 272 X 184 mm	253 X 258 X 179 mm	1.55 kg
CN-7609	306 X 272 X 241 mm	253 X 258 X 236 mm	2.00 kg



Lid Barrier system

Weight: 0.97 kg

CN-7630	
CN-7631	
CN-7632	
CN-7633	
CN-7634	
CN-7635	

Safety Lids

Weight: 0.66 kg

CN-7412	
CN-7413	
CN-7414	
CN-7415	
CN-7416	
CN-7417	











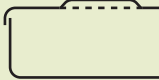
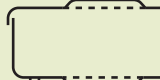
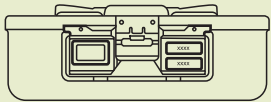



















XL Size

Bio-Barrier Model

Sterile Container System

<p>Specifications</p> <p>Sizes</p>	<p>Lid (with barrier)</p>  <p>Box (Non-Perforated)</p>	<p>Lid (with barrier)</p>  <p>Box (with barrier)</p>
<p>590 X 370 X h mm</p> 	<p>CN-7711 </p> <p>CN-7712 </p> <p>CN-7713 </p> <p>CN-7714 </p> <p>CN-7715 </p> <p>CN-7716 </p> <p style="text-align: center;">h = 125 mm</p>	<p>CN-7741 </p> <p>CN-7742 </p> <p>CN-7743 </p> <p>CN-7744 </p> <p>CN-7745 </p> <p>CN-7746 </p> <p style="text-align: center;">h = 135 mm</p>
<p>590 X 370 X h mm</p> 	<p>CN-7717 </p> <p>CN-7718 </p> <p>CN-7719 </p> <p>CN-7720 </p> <p>CN-7721 </p> <p>CN-7722 </p> <p style="text-align: center;">h = 185 mm</p>	<p>CN-7747 </p> <p>CN-7748 </p> <p>CN-7749 </p> <p>CN-7750 </p> <p>CN-7751 </p> <p>CN-7752 </p> <p style="text-align: center;">h = 195 mm</p>
<p>Ps: All container measurements cover the outer size of the lids.</p>		

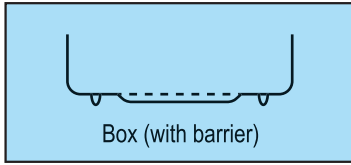

CODE	OUTSIDE	INSIDE	WEIGHT
CN-7700	595 X 365 X 125 mm	530 X 350 X 100 mm	2.620 kg
CN-7701	595 X 365 X 187 mm	530 X 350 X 162 mm	3.440 kg

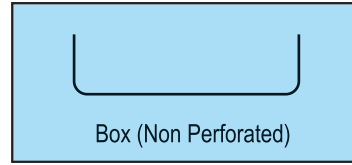

CODE	OUTSIDE	INSIDE	WEIGHT
CN-7702	595 X 365 X 105 mm	530 X 350 X 100 mm	2.20 kg
CN-7703	595 X 365 X 167 mm	530 X 350 X 167 mm	3.00 kg



Lid Barrier system

Weight: 2.037 kg











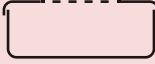

























































CN-7771	
CN-7772	
CN-7773	
CN-7774	
CN-7775	
CN-7776	





Dental Mini & Special Model

Sterile Container System

Specifications Sizes	Lid (Perforated)	Lid (Perforated)	Lid (Non Perforated)		
	 Box (Non-Perforated)	 Box (Perforated)	 Box (Non-Perforated)	 Box (Perforated)	 Box (Non-Perforated)
320 X 190 X 50 mm 	CN-61800  CN-61801  CN-61802  CN-61803  CN-61804  CN-61805 	CN-61820  CN-61821  CN-61822  CN-61823  CN-61824  CN-61825 	CN-61840  CN-61841  CN-61842  CN-61843  CN-61844  CN-61845 	CN-61860 	CN-61865 
320 X 190 X 65 mm 	CN-61806  CN-61807  CN-61808  CN-61809  CN-61810  CN-61811 	CN-61826  CN-61827  CN-61828  CN-61829  CN-61830  CN-61831 	CN-61846  CN-61847  CN-61848  CN-61849  CN-61850  CN-61851 	CN-61861 	CN-61866 
320 X 190 X 130 mm 	CN-61812  CN-61813  CN-61814  CN-61815  CN-61816  CN-61817 	CN-61832  CN-61833  CN-61834  CN-61835  CN-61836  CN-61837 	CN-61852  CN-61853  CN-61854  CN-61855  CN-61856  CN-61857 	CN-61862 	CN-61867 

Ps: All container measurements cover the outer size of the lids.



CN-31070 274 x 172 x 43 mm
WIRE BASKET

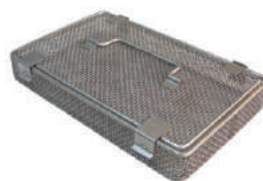

CN-3611 274 x 172 x 43 mm
WIRE BASKET WITH LID.



CN-3609 273 x 180 x 13 mm
STORAGE FRAME
for dental model

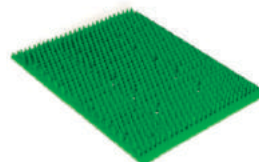

CN-2529G 260 x 180 mm
SILICONE MAT



CN-3610 277 x 175 mm
DRAPE RETAINER

Perforated Bottoms



outside	320 x 186 x 38 mm
inside	276 x 185 x 23 mm
weight	0,45 kg

CN-61860

Solid Bottoms



outside	320 x 186 x 38 mm
inside	276 x 185 x 36 mm
weight	0,35 kg

CN-61865



outside	320 x 186 x 55 mm
inside	276 x 185 x 40 mm
weight	0,50 kg

CN-61861



outside	320 x 186 x 55 mm
inside	276 x 185 x 43 mm
weight	0,40 kg

CN-61866



outside	320 x 186 x 123 mm
inside	276 x 185 x 108 mm
weight	0,70 kg

CN-61862



outside	320 x 186 x 123 mm
inside	276 x 185 x 121 mm
weight	0,65 kg

CN-61867

Perforated Lids



CN-61880	
CN-61881	
CN-61882	
CN-61883	
CN-61884	
CN-61885	

Weight: 0.50 kg

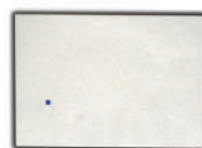

CN-3615
Single use paper filter 100 pcs.
With indicator No marking.



CN-2743
Teflon filter
Number of sterilization cycle > 1200

Bio-Barrier Lids



CN-71880	
CN-71881	
CN-71882	
CN-71883	
CN-71884	
CN-71885	

Weight: 0.90 kg

Removal Lids

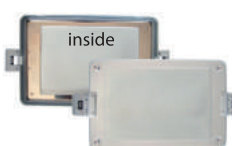

CN-61870	
CN-61871	
CN-61872	
CN-61873	
CN-61874	
CN-61875	

Weight: 0.60 kg



Specifications Sizes	Lid (Perforated)	Lid (Perforated)	Lid (Non Perforated)		
	Box (Non-Perforated)	Box (Perforated)	Box (Non-Perforated)	Box (Perforated)	Box (Non-Perforated)
315 X 135 X 40 mm 	CN-61900 CN-61901 CN-61902 CN-61903 CN-61904 CN-61905	CN-61920 CN-61921 CN-61922 CN-61923 CN-61924 CN-61925	CN-61940 CN-61941 CN-61942 CN-61943 CN-61944 CN-61945	CN-61960	CN-61965
315 X 135 X 70 mm 	CN-61906 CN-61907 CN-61908 CN-61909 CN-61910 CN-61911	CN-61926 CN-61927 CN-61928 CN-61929 CN-61930 CN-61931	CN-61946 CN-61947 CN-61948 CN-61949 CN-61950 CN-61951	CN-61961	CN-61966
315 X 135 X 100 mm 	CN-61912 CN-61913 CN-61914 CN-61915 CN-61916 CN-61917	CN-61932 CN-61933 CN-61934 CN-61935 CN-61936 CN-61937	CN-61952 CN-61953 CN-61954 CN-61955 CN-61956 CN-61957	CN-61962	CN-61967

Ps: All container measurements cover the outer size of the lids.



CN-31073 267 x 125 x 50 mm
WIRE BASKET



CN-2993 267 x 125 x 50 mm
WIRE BASKET WITH LID.



CN-2990 270 x 125 mm
DRAPE RETAINER



CN-2991
Portable carrier for small containers.
Wire suspenders adjustable as required.
Adjusting key of suspender is included.
Width: 325 mm, Height: 328 mm, Depth: 145 mm



CN-2992 270 x 125 mm
WIRE BASE

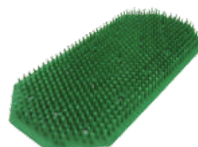

CN-2520G 275 x 125 mm
SILICONE MAT

Perforated Bottoms



outside 315 x 132 x 32 mm
inside 273 x 128 x 24 mm
weight 0,30 kg

CN-61960



outside 315 x 132 x 58 mm
inside 273 x 128 x 50 mm
weight 0,40 kg

CN-61961



outside 315 x 132 x 92 mm
inside 273 x 128 x 84 mm
weight 0,50 kg

CN-61962

Solid Bottoms



outside 296 x 132 x 32 mm
inside 273 x 128 x 30 mm
weight 0,20 kg

CN-61965



outside 296 x 132 x 58 mm
inside 273 x 128 x 56 mm
weight 0,35 kg

CN-61966



outside 296 x 132 x 92 mm
inside 273 x 128 x 90 mm
weight 0,45 kg

CN-61967



CN-2761
Single use paper filter 100 pcs.
With indicator. No marking.



CN-2744
Teflon filter
Number of sterilization scycle > 1200

Perforated Lid



CN-61970	
CN-61971	
CN-61972	
CN-61973	
CN-61974	
CN-61975	

Weight: 0.35 kg

Removal Lids











































CN-61980	
CN-61981	
CN-61982	
CN-61983	
CN-61984	
CN-61985	

Weight: 0.30 kg











































IMPLANT Model Containers

Specifications / Sizes	Lid (Perforated)	Lid (Perforated)	Lid (Non Perforated)	NON FILTER
	Box (Non-Perforated)	Box (Perforated)	Box (Non-Perforated)	
300 X 149 X 65 mm 	CN-5010  CN-5011  CN-5012  CN-5013  CN-5014  CN-5015 	CN-5022  CN-5023  CN-5024  CN-5025  CN-5026  CN-5027 	CN-5034  CN-5035  CN-5036  CN-5037  CN-5038  CN-5039 	
500 X 169 X 75 mm 	CN-5016  CN-5017  CN-5018  CN-5019  CN-5020  CN-5021 	CN-5028  CN-5029  CN-5030  CN-5031  CN-5032  CN-5033 	CN-5040  CN-5041  CN-5042  CN-5043  CN-5044  CN-5045 	

Ps: All container measurements cover the outer size of the lids.







MINI IMPLANT Model Containers

Specifications / Sizes	Lid (Perforated)	Lid (Perforated)	Lid (Non Perforated)	NON FILTER
	Box (Non-Perforated)	Box (Perforated)	Box (Non-Perforated)	
160 X 70 X 60 mm 	CN-5200  CN-5201  CN-5202  CN-5203  CN-5204  CN-5205 	CN-5212  CN-5213  CN-5214  CN-5215  CN-5216  CN-5217 	CN-5224  CN-5225  CN-5226  CN-5227  CN-5228  CN-5229 	
200 X 145 X 60 mm 	CN-5206  CN-5207  CN-5208  CN-5209  CN-5210  CN-5211 	CN-5218  CN-5219  CN-5220  CN-5221  CN-5222  CN-5223 	CN-5230  CN-5231  CN-5232  CN-5233  CN-5234  CN-5235 	

Ps: All container measurements cover the outer size of the lids.



**BRUSH Model
Containers**



-  CN-2044 Black
-  CN-2045 Red
-  CN-2046 Blue
-  CN-2047 Green
-  CN-2048 Yellow
-  CN-2049 Grey

Container for brush 280 x 285 x 85 mm with wall mounting fixtures, Maximum 20 each brushes can be stored container. To take the brush, please move the handle to right or left direction under the container.

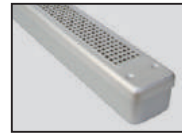

non filter

Specifications / Sizes	Lid (Perforated)	Lid (Perforated)
	Box (Non-Perforated)	Box (Perforated)
250 X 60 X 50 mm 	CN-5060 ● CN-5061 ● CN-5062 ● CN-5063 ● CN-5064 ● CN-5065 ●	CN-5072 ● CN-5073 ● CN-5074 ● CN-5075 ● CN-5076 ● CN-5077 ●
450 X 70 X 70 mm 	CN-5066 ● CN-5067 ● CN-5068 ● CN-5069 ● CN-5070 ● CN-5071 ●	CN-5078 ● CN-5079 ● CN-5080 ● CN-5081 ● CN-5082 ● CN-5083 ●



SCOPY Model Containers



Ps: All container measurements cover the outer size of the lids.

Specifications / Sizes	Lid (Perforated)	Lid (Perforated)
	Box (Non-Perforated)	Box (Perforated)
250 X 60 X 50 mm 	CN-5100 ● CN-5101 ● CN-5102 ● CN-5103 ● CN-5104 ● CN-5105 ●	CN-5115 ● CN-5116 ● CN-5117 ● CN-5118 ● CN-5119 ● CN-5120 ●
450 X 70 X 70 mm 	CN-5106 ● CN-5107 ● CN-5108 ● CN-5109 ● CN-5110 ● CN-5111 ●	CN-5121 ● CN-5122 ● CN-5123 ● CN-5124 ● CN-5125 ● CN-5126 ●



SCOPY Model Containers
(with silicon stand, lock, label)

Ps: All container measurements cover the outer size of the lids.

Specifications	Lid (Perforated)	Lid (Perforated)	Lid (Non Perforated)		
	Box (Non-Perforated)	Box (Perforated)	Box (Non-Perforated)	Box (Perforated)	Box (Non-Perforated)
Sizes 285 X 280 X 55 mm 	CN-61710 CN-61711 CN-61712 CN-61713 CN-61714 CN-61715	CN-61730 CN-61731 CN-61732 CN-61733 CN-61734 CN-61735	CN-61750 CN-61751 CN-61752 CN-61753 CN-61754 CN-61755	CN-61770	CN-61775
285 X 280 X 85 mm 	CN-61716 CN-61717 CN-61718 CN-61719 CN-61720 CN-61721	CN-61736 CN-61737 CN-61738 CN-61739 CN-61740 CN-61741	CN-61756 CN-61757 CN-61758 CN-61759 CN-61760 CN-61761	CN-61771	CN-61776

Ps: All container measurements cover the outer size of the lids.



CN-2490 255 x 250 x 30 mm
CN-2491 255 x 250 x 50 mm
 WIRE BASKET



CN-2482 255 x 255 x 30 mm
 WIRE BASE



CN-2480 255 x 255 mm
 DRAPE RETAINER



CN-2481 255 x 255 x 30 mm
 DRAPE RETAINER

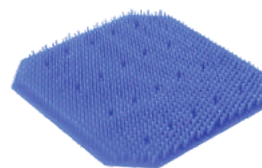

CN-2521B 255 x 255 mm
 SILICON MAT



CN-2740
 Single use paper filter 100 pcs.



CN-2742
 Teflon Filter
 Number of sterilization cycle > 1200

Perforated Bottoms



outside 209 x 275 x 40 mm
inside 264 x 270 x 19 mm
weight 0,70 kg

CN-61770

Solid Bottoms



outside 290x 275 x 40 mm
inside 264 x 270 x 35 mm
weight 0,60 kg

CN-61775



outside 290 x 275 x 72 mm
inside 264 x 270 x 52 mm
weight 0,90 kg

CN-61771



outside 290 x 275 x 72 mm
inside 264 x 270 x 66 mm
weight 0,70 kg

CN-61776

Perforated Lids



CN-61780	
CN-61781	
CN-61782	
CN-61783	
CN-61784	
CN-61785	

Weight: 0.65 kg

Bio-Barrier Lids



CN-71780	
CN-71781	
CN-71782	
CN-71783	
CN-71784	
CN-71785	

Weight: 0.85 kg

Safety Lids



CN-61418	
CN-61419	
CN-61420	
CN-61421	
CN-61422	
CN-61423	

Weight: 0.55 kg

Bio-Barrier Safety Lids



CN-71418	
CN-71419	
CN-71420	
CN-71421	
CN-71422	
CN-71423	

Weight: 0.60 kg

Removal Lids



CN-61790	
CN-61791	
CN-61792	
CN-61793	
CN-61794	
CN-61795	

Weight: 0.50 kg

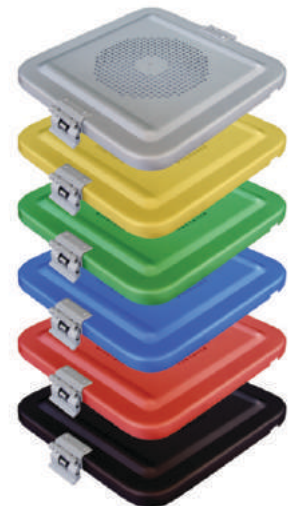

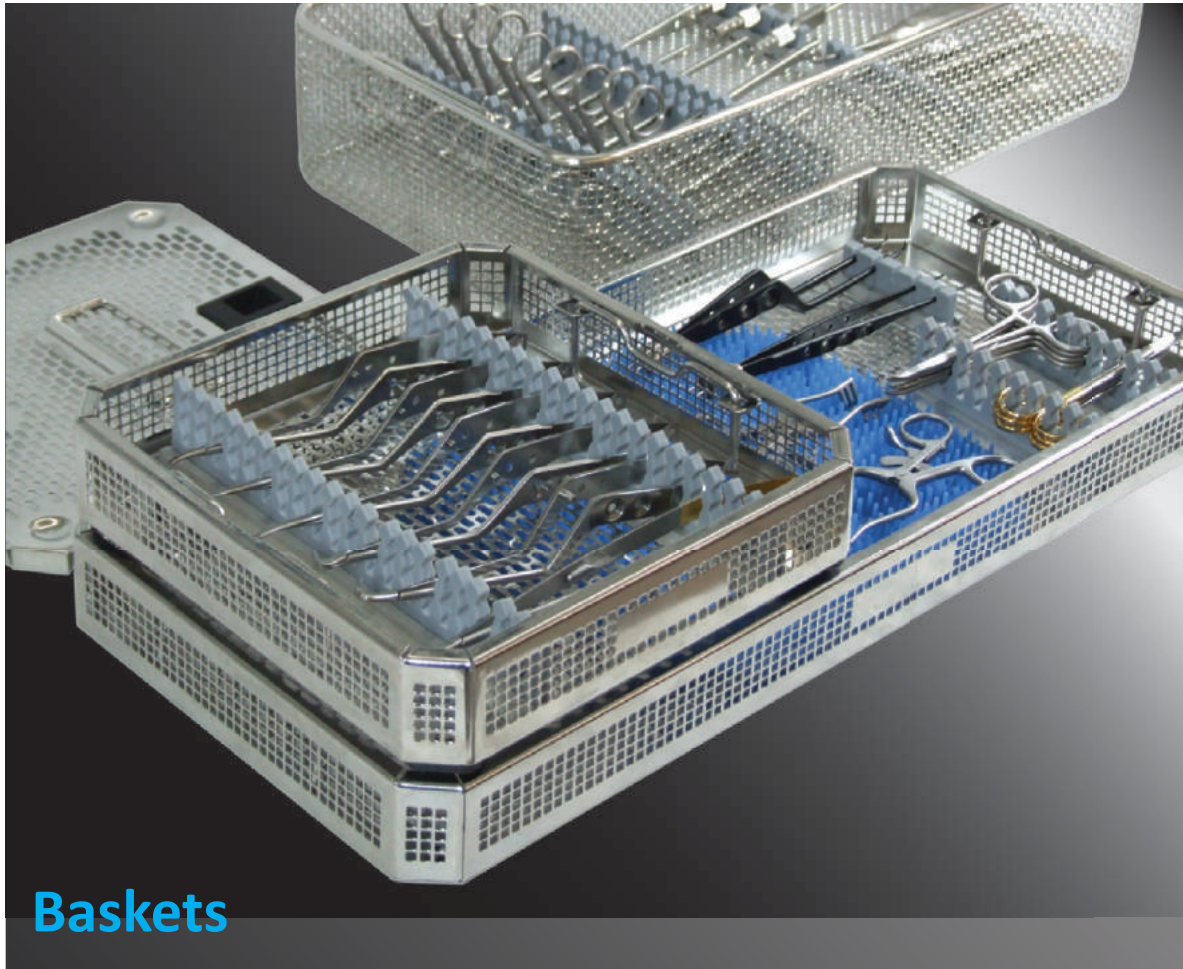

Sterile Container System



CN-31010 540 x 250 x 30 mm
CN-31011 540 x 250 x 50 mm
CN-31012 540 x 250 x 70 mm
CN-31013 540 x 250 x 100 mm
 wire basket with lid

CN-31014 ONLY LID (for baskets)



CN-2460 540 x 250 x 30 mm
CN-2461 540 x 250 x 50 mm
CN-2462 540 x 250 x 70 mm
CN-2463 540 x 250 x 100 mm
 wire basket



CN-31020 480 x 250 x 30 mm
CN-31021 480 x 250 x 50 mm
CN-31022 480 x 250 x 70 mm
CN-31023 480 x 250 x 100 mm
 wire basket with lid

CN-31024 ONLY LID (for baskets)

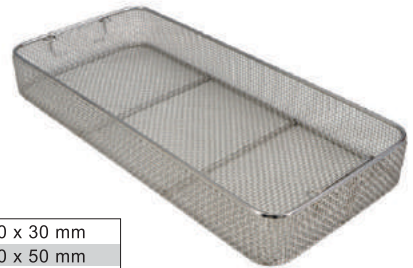

CN-2450 480 x 250 x 30 mm
CN-2451 480 x 250 x 50 mm
CN-2452 480 x 250 x 70 mm
CN-2453 480 x 250 x 100 mm
 wire basket



CN-31030 405 x 250 x 30 mm
CN-31031 405 x 250 x 50 mm
CN-31032 405 x 250 x 70 mm
CN-31033 405 x 250 x 100 mm
 wire basket with lid

CN-31034 ONLY LID (for baskets)



CN-21500 405 x 250 x 30 mm
CN-21501 405 x 250 x 50 mm
CN-21502 405 x 250 x 70 mm
CN-21503 405 x 250 x 100 mm
 wire basket





CN-31040 255 x 250 x 30 mm
CN-31041 255 x 250 x 50 mm
CN-31042 255 x 250 x 70 mm
CN-31043 255 x 250 x 100 mm
 wire basket with lid

CN-31045 ONLY LID (for baskets)





CN-2490 255 x 250 x 30 mm
CN-2491 255 x 250 x 50 mm
CN-2492 255 x 250 x 70 mm
CN-2493 255 x 250 x 100 mm
 wire basket

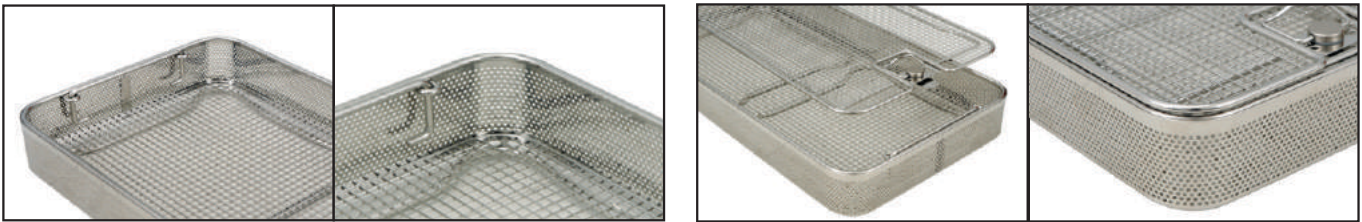

Wire Basket With Perforated Metal Plate

 <p>WIRE BASKET</p>	<p>CN-2461M 540 x 250 x 50 mm CN-2462M 540 x 250 x 70 mm CN-2463M 540 x 250 x 100 mm</p>	 <p>WIRE BASKET WITH LID</p>	<p>CN-31011M 540 x 250 x 50 mm CN-31012M 540 x 250 x 70 mm CN-31013M 540 x 250 x 100 mm</p>
	<p>CN-2451M 480 x 250 x 50 mm CN-2452M 480 x 250 x 70 mm CN-2453M 480 x 250 x 100 mm</p>		<p>CN-31014M ONLY LID (for baskets)</p> <p>CN-31021M 480 x 250 x 50 mm CN-31022M 480 x 250 x 70 mm CN-31023M 480 x 250 x 100 mm</p> <p>CN-31024M ONLY LID (for baskets)</p>

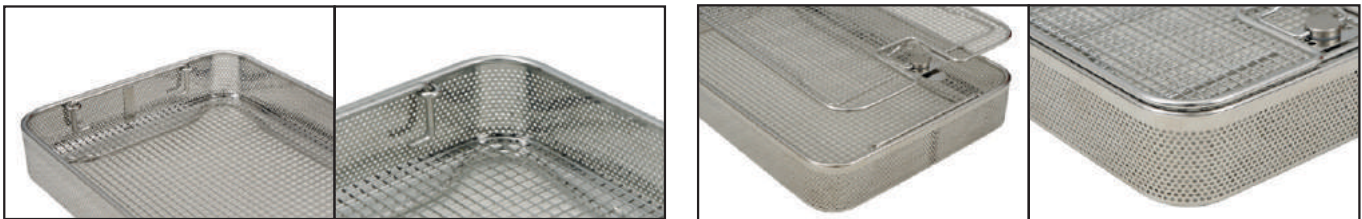

 <p>WIRE BASKET</p>	<p>CN-21501M 405 x 250 x 50 mm CN-21502M 405 x 250 x 70 mm CN-21503M 405 x 250 x 100 mm</p>	 <p>WIRE BASKET WITH LID</p>	<p>CN-31031M 405 x 250 x 50 mm CN-31032M 405 x 250 x 70 mm CN-31033M 405 x 250 x 100 mm</p> <p>CN-31034M ONLY LID (for baskets)</p>
-------------------------------------------------------------------------------------------------------	----------------------------------------------------------------------------------------------------------------------------	-----------------------------------------------------------------------------------------------------------------	---------------------------------------------------------------------------------------------------------------------------------------------------------------------------



 <p>WIRE BASKET</p>	<p>CN-2491M 255 x 250 x 50 mm CN-2492M 255 x 250 x 70 mm CN-2493M 255 x 250 x 100 mm</p>	 <p>WIRE BASKET WITH LID</p>	<p>CN-31041M 255 x 250 x 50 mm CN-31042M 255 x 250 x 70 mm CN-31043M 255 x 250 x 100 mm</p> <p>CN-31045M ONLY LID (for baskets)</p>
--------------------------------------------------------------------------------------------------------	-------------------------------------------------------------------------------------------------------------------------	------------------------------------------------------------------------------------------------------------------	---------------------------------------------------------------------------------------------------------------------------------------------------------------------------

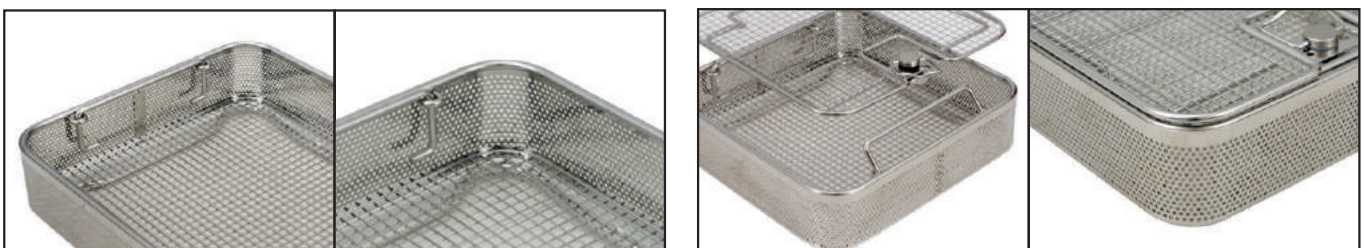

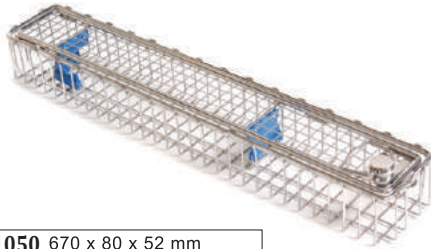

CN-31050 670 x 80 x 52 mm
CN-31051 460 x 80 x 52 mm
CN-31052 290 x 80 x 52 mm
 Endoscope basket

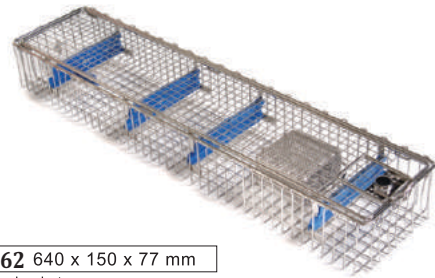

CN-31062 640 x 150 x 77 mm
 Endoscope basket



CN-3611 274 x 172 x 43 mm
 Wire basket



CN-2993 267 x 125 x 50 mm
 Wire basket



CN-31070 274 x 172 x 43 mm
 Wire basket





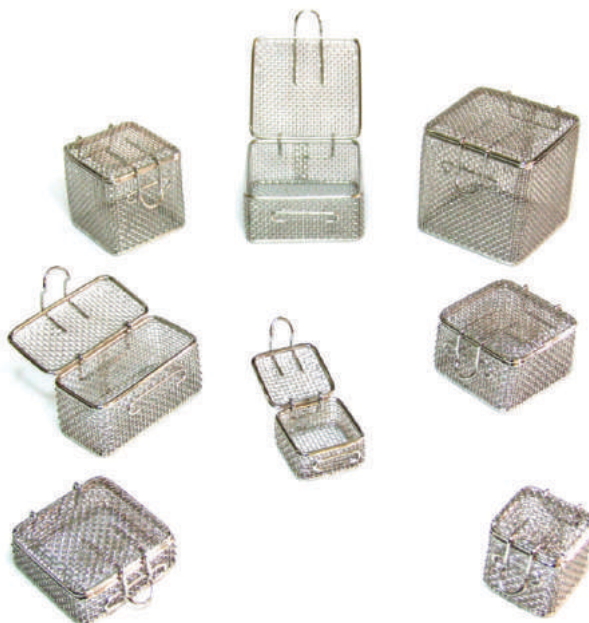



CN-31073 267 x 125 x 50 mm
 Wire basket

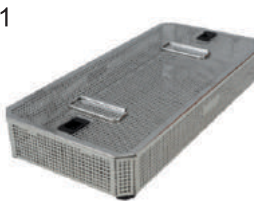

Small fine mesh baskets with lid
Mesh distance = 2 mm x 2 mm

- CN-31100** 30 x 30 x 30 mm
- CN-31101** 40 x 40 x 20 mm
- CN-31102** 40 x 40 x 40 mm
- CN-31103** 60 x 60 x 20 mm
- CN-31104** 60 x 60 x 40 mm
- CN-31105** 60 x 60 x 60 mm
- CN-31106** 80 x 80 x 20 mm
- CN-31107** 80 x 40 x 40 mm
- CN-31108** 80 x 80 x 40 mm
- CN-31109** 80 x 80 x 60 mm
- CN-31110** 80 x 80 x 80 mm
- CN-31111** 100 x 100 x 10 mm
- CN-31112** 120 x 120 x 30 mm
- CN-31113** 120 x 120 x 60 mm
- CN-31114** 120 x 120 x 80 mm
- CN-31115** 240 x 240 x 30 mm
- CN-31116** 240 x 240 x 60 mm
- CN-31117** 240 x 240 x 80 mm
- CN-31118** 240 x 240 x 100 mm



Specifications						
Sizes	 540 x 253 x h	h mm	 box and lid	 box	 lid	
		1/1	30 50 70 100	CN-3720 CN-3721 CN-3722 CN-3723	CN-3740 CN-3741 CN-3742 CN-3743	CN-3760
1/1	485 x 253 x h	30 50 70 100	CN-3724 CN-3725 CN-3726 CN-3727	CN-3744 CN-3745 CN-3746 CN-3747	CN-3761	
3/4	405 x 253 x h	30 50 70 100	CN-3728 CN-3729 CN-3730 CN-3731	CN-3748 CN-3749 CN-3750 CN-3751	CN-3762	
1/2	244 x 253 x h	30 50 70 100	CN-3732 CN-3733 CN-3734 CN-3735	CN-3752 CN-3753 CN-3754 CN-3755	CN-3763	
Dental	 275 x 175 x h	40	CN-3736	CN-3756	CN-3764	
		95	CN-3737	CN-3757		
Small	 265 x 125 x h	50	CN-3738	CN-3758	CN-3765	

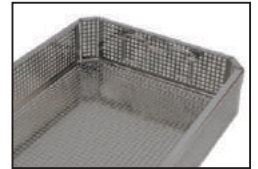
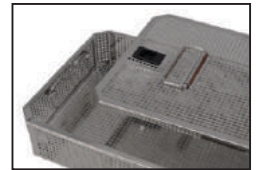

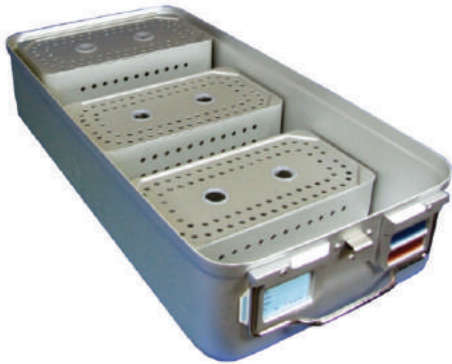

CN-31119
Aluminium basket, with lid
245 x 130 x 55



CN-31120
Aluminium basket, with lid
245 x 130 x 70









CN-31121
Aluminium basket, with lid
245 x 130 x 105 mm

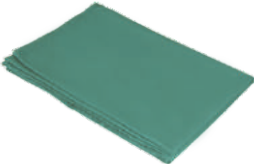

CN-31080 600 x 400 x 150 mm
CN-31081 600 x 400 x 300 mm
 Laundry baskets



CN-31085 600 x 400 x 150 mm
CN-31086 600 x 400 x 300 mm
 Laundry baskets

Drape	Sizes	for MODEL
	<p>CN-21600 130 x 60 cm CN-21601 140 x 100 cm CN-21602 185 x 45 cm CN-21603 180 x 60 cm</p>	<p>1/1 </p>
	<p>CN-21615 140 x 100 cm</p>	<p>3/4 </p>
	<p>CN-21630 90 x 60 cm CN-21631 90 x 80 cm CN-21632 130 x 45 cm CN-21633 130 x 60 cm</p>	<p>1/2 </p>
	<p>CN-21640 90 x 60 cm CN-21641 90 x 80 cm</p>	<p>Flat </p>
	<p>CN-21650 60 x 40 cm</p>	<p>Mini </p>
	<p>CN-21660 60 x 40 cm CN-21661 65 x 65 cm CN-21662 85 x 85 cm</p>	<p>Dental </p>

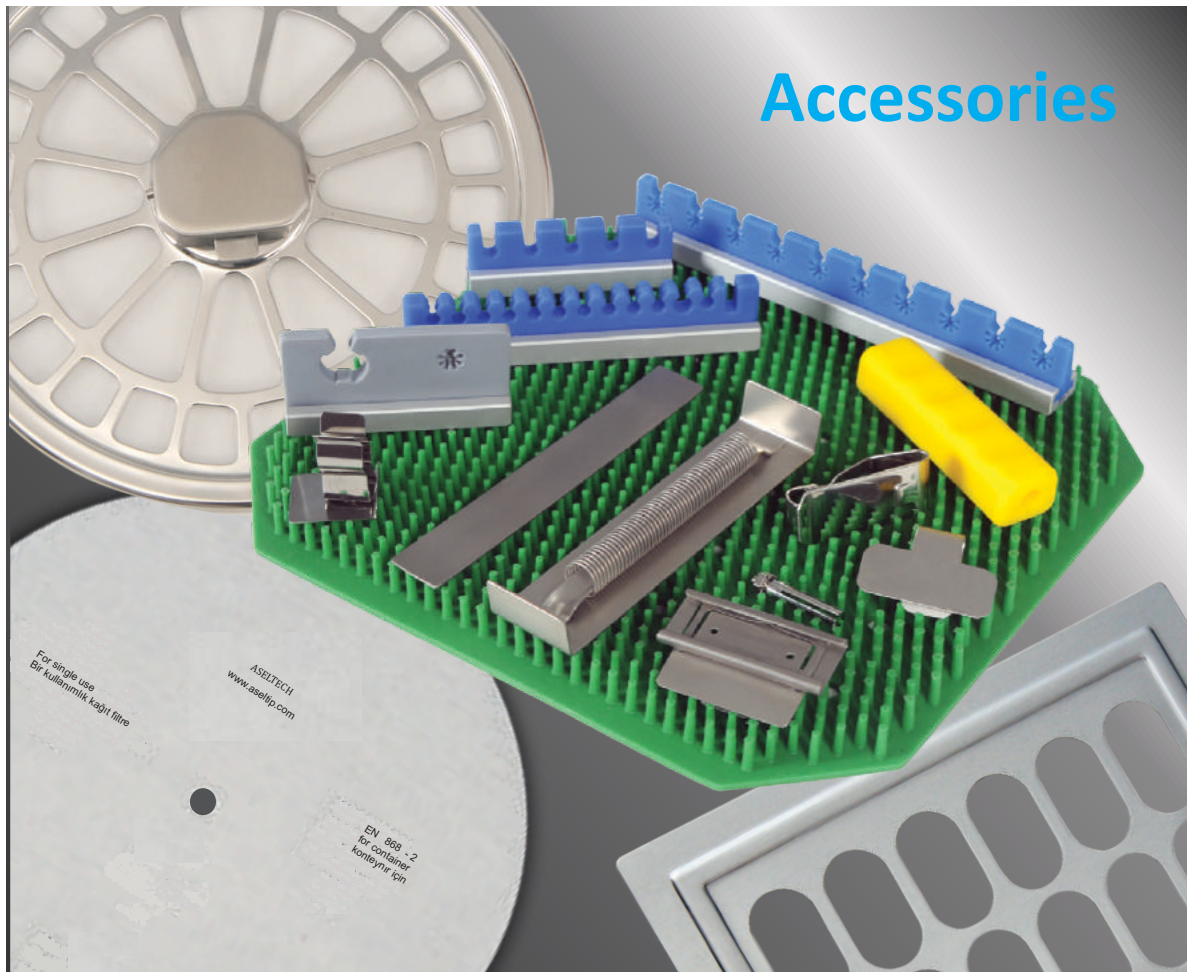



The security plastic seals will be broken upon the lock is opened and this action makes it possible to follow up the sterilization process.



CN-2663
Security seal, made of plastic
100pcs. with indicator. (Blue)



CN-2662
Security seal, made of plastic
100pcs. with indicator. (Red)



CN-2664
Security seal, made of plastic
100pcs.(Blue)



CN-2660
Security seal, made of plastic
100pcs.(Red)



CN-2661
Security seal, made of plastic
100pcs. with number.(Blue)



CN-2665
Security seal, made of plastic
100pcs. with number.(Red)



CN-2672
Labels, paper 100 pcs.
With indicator.
For full and half size containers

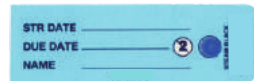

CN-2673
Labels, paper 100 pcs.
With indicator.
For small size and special containers

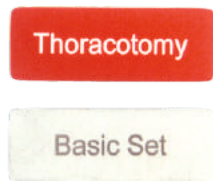

- CN-2700
- CN-2701
- CN-2702
- CN-2703
- CN-2704
- CN-2705

Coloured identification labels
Engraved to your specifications
Maximum 16 letters

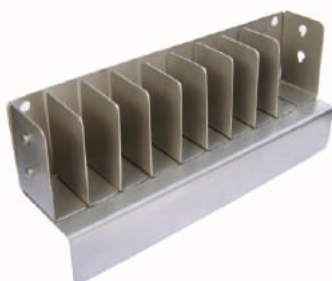

CN-2690
Dispenser for identification labels



CN-2680
Dispenser for identification labels

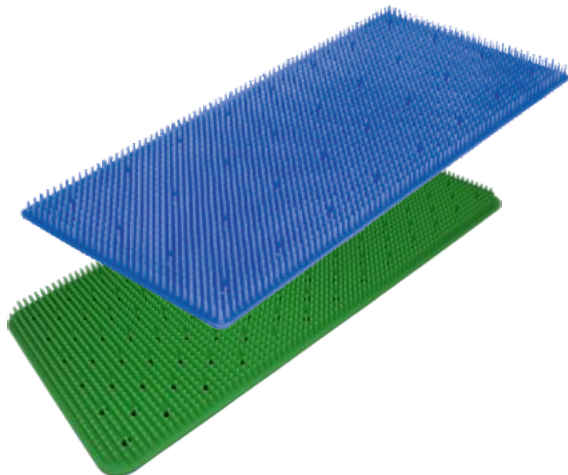

BLUE COLOURS

CN-2526B	520 x 230 mm
CN-2528B	470 x 230 mm
CN-2525B	440 x 230 mm
CN-2524B	380 x 230 mm

GREEN COLOURS

CN-2526G	520 x 230 mm
CN-2528G	470 x 230 mm
CN-2525G	440 x 230 mm
CN-2524G	380 x 230 mm

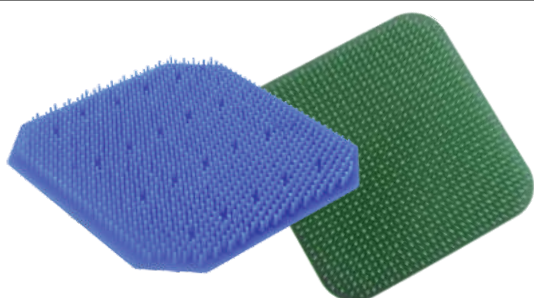

BLUE COLOURS

CN-2523B	300 x 300 mm
CN-2527B	230 x 220 mm
CN-2521B	250 x 235 mm

GREEN COLOURS

CN-2523G	300 x 300 mm
CN-2527G	230 x 220 mm
CN-2521G	250 x 235 mm

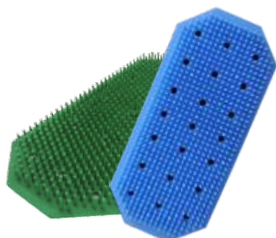

BLUE COLOURS

CN-2529B	260 x 180 mm
CN-2520B	275 x 125 mm

GREEN COLOURS

CN-2529G	260 x 180 mm
CN-2520G	275 x 125 mm



CN-2530	250 x 240 x 2.0 mm
CN-2531	480 x 250 x 2.0 mm

Silicone mat
Enables surgical instruments to be stored
without slip and dry well

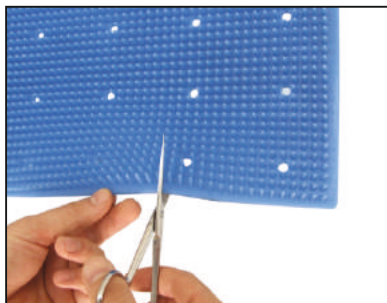



CN-12100 L= 250 mm H= 41 mm
 CN-12101 L= 152 mm H= 41 mm
 CN-12102 L= 125 mm H= 41 mm
 CN-12145 L= 97 mm H= 41 mm

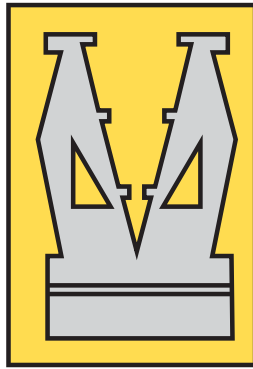

CN-12103 L= 240 mm H= 41 mm
 CN-12104 L= 150 mm H= 41 mm
 CN-12105 L= 120 mm H= 41 mm
 CN-12146 L= 90 mm H= 41 mm

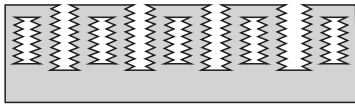
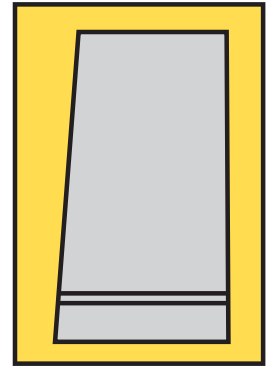

CN-12106 L= 238 mm H= 41 mm
 CN-12107 L= 150 mm H= 41 mm
 CN-12108 L= 119 mm H= 41 mm
 CN-12147 L= 87 mm H= 41 mm

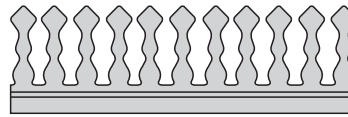
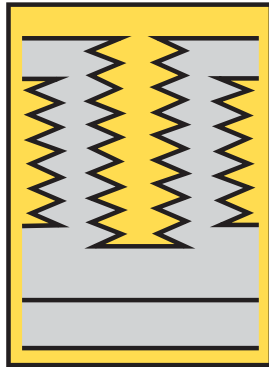

CN-12109 L= 238 mm H= 41 mm
 CN-12110 L= 158 mm H= 41 mm
 CN-12111 L= 112 mm H= 41 mm
 CN-12148 L= 77 mm H= 41 mm

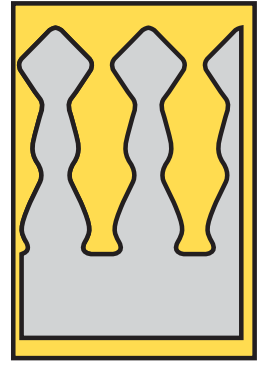

CN-12112 L= 178 mm H= 20 mm
 Instruments holder, from Ø 3 to 8 mm

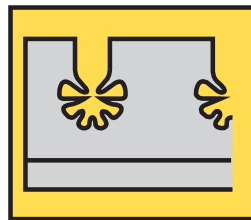

CN-12113 L= 73 mm H= 20 mm
 Instruments holder, Ø 5 mm

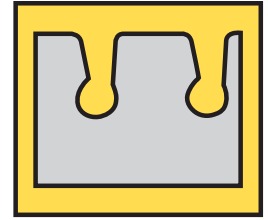

CN-12114 L= 73 mm H= 20 mm
 Instruments holder, Ø 5 mm

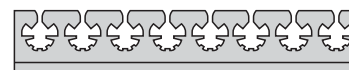
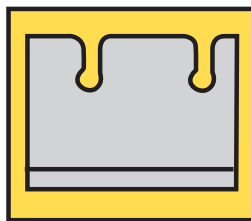

CN-12115 L= 178 mm H= 30 mm
 Instruments holder, from Ø 3 to 8 mm

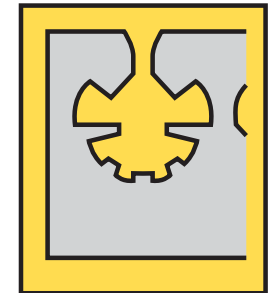

CN-12116 L= 121 mm H= 18 mm

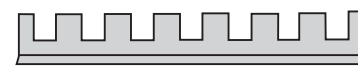
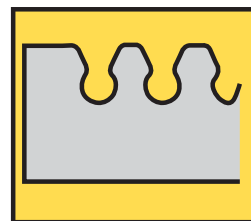

CN-12117 L= 123 mm H= 18 mm

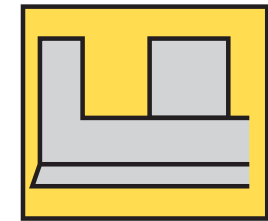



CN-12124 L= 178 mm H= 20 mm
Instruments holder, from Ø 3 mm

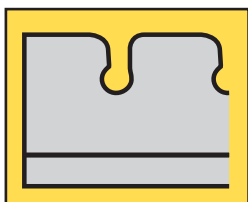

CN-12125 L= 178 mm H= 20 mm
Instruments holder, from Ø 5 mm

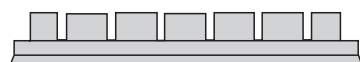
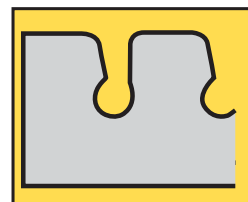

CN-12123 L= 123 mm H= 18 mm

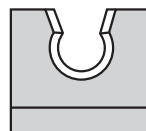
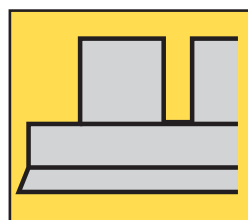

CN-12127 L= 23.5 mm H= 21 mm
Ø 8 mm

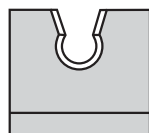
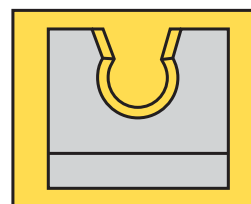

CN-12129 L= 23.5 mm H= 21 mm
Ø 5 mm

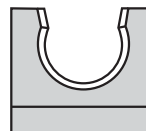
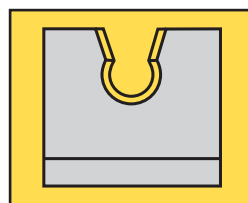

CN-12128 L= 23.5 mm H= 21 mm
Ø 13 mm

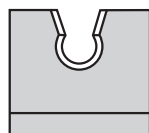
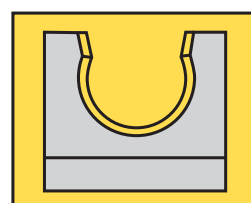

CN-12126 L= 23.5 mm H= 21 mm
Ø 10.5 mm

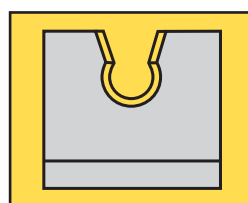

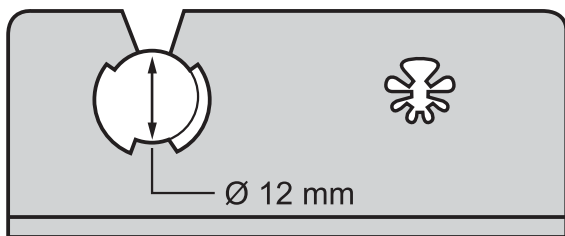

CN-12141 L= 72 mm H= 30 mm
Endoscope holder, double
one side \varnothing 15 mm open
one side from \varnothing 3 to \varnothing 15 mm

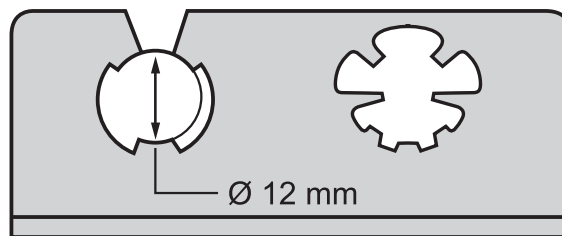

CN-12130 L= 72 mm H= 30 mm
Endoscope holder, double
one side \varnothing 15 mm open
one side from \varnothing 3 to \varnothing 15 mm

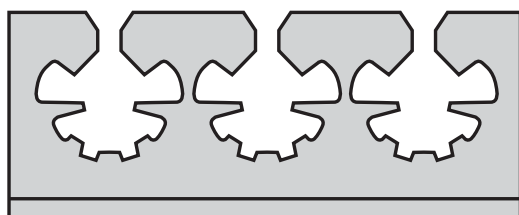

CN-12131 L= 72 mm H= 30 mm
Instruments holder
from \varnothing 3 to \varnothing 15 mm

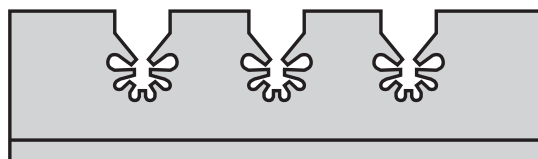

CN-12132 L= 72 mm H= 30 mm
Instruments holder
from \varnothing 3 to \varnothing 8 mm

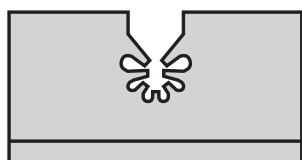

CN-12133 L= 38 mm H= 20 mm
Endoscope holder, double
one side 12 mm open
one side from \varnothing 3 to \varnothing 8 mm

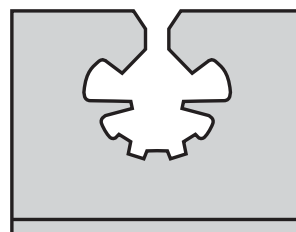

CN-12134 L= 38 mm H= 30 mm
Endoscope holder, double
one side 12 mm open
one side from \varnothing 3 to \varnothing 8 mm

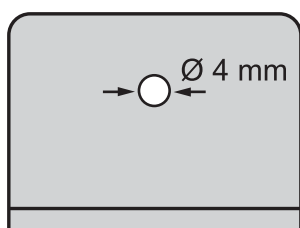

CN-12135 L= 38 mm H= 29 mm
Endoscope holder, \varnothing 4 mm closed

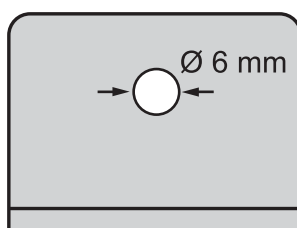

CN-12136 L= 38 mm H= 29 mm
Endoscope holder, \varnothing 6 mm closed

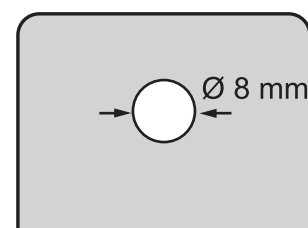

CN-12137 L= 38 mm H= 29 mm
Endoscope holder, \varnothing 8 mm closed

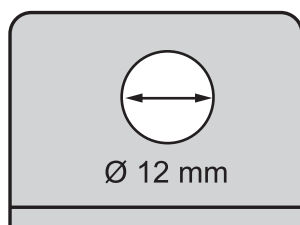

CN-12138 L= 38 mm H= 29 mm
Endoscope holder, \varnothing 12 mm closed

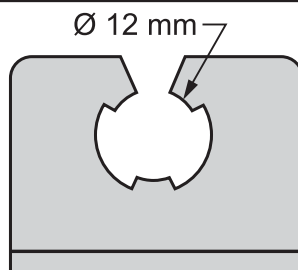

CN-12139 L= 38 mm H= 29 mm
Endoscope holder, \varnothing 12 mm closed

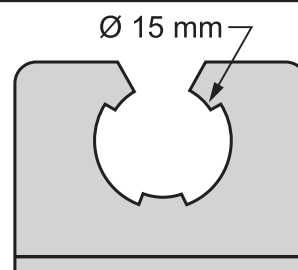

CN-12140 L= 38 mm H= 29 mm
Endoscope holder, \varnothing 15 mm closed



CN-2740
Single Textile
for half, middle
and full size containers



CN-2741
Single use paper filter 100 pcs.
With indicator. No marking



CN-2742
Teflon filter
Number of sterilization cycle > 1200

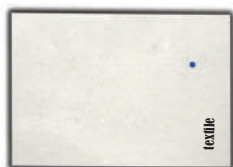
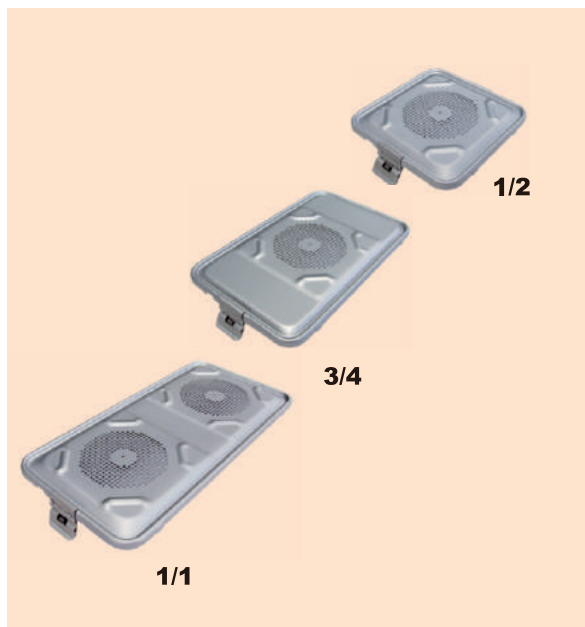

CN-3612
Single Textile

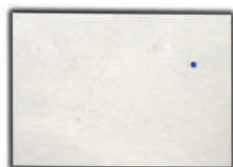

CN-3615
Single use paper filter 100 pcs.
With indicator. No marking



CN-2743
Teflon filter
Number of sterilization cycle > 1200



CN-2760
Single Textile



CN-2761
Single use paper filter 100 pcs.
With indicator. No marking



CN-2744
Teflon filter
Number of sterilization cycle > 1200





CN-2720
Filter retainer, for 1/1, 3/4, 1/2, XL
For disposable paper filter
CN-2721
For PTFE Teflon filter

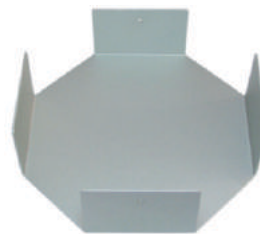

CN-2730
Filter dispenser



CN-21715
Filter Retainer, for dental model



CN-21708
Filter dispenser



CN-21716
Filter Retainer, for mini model



CN-21709
Filter dispenser

SILICONE GASKETS FOR LIDS



	Model	Size
CN-3950	Mini	300 x 140 mm
CN-3951	Dental	310 x 190 mm
CN-3952	Flat	285 x 280 mm
CN-3953	1/2	285 x 280 mm
CN-3954	3/4	465 x 280 mm
CN-3955	1/1	580 x 280 mm
CN-3956	XL	590 x 370 mm

For mounting

- CN-2710 Red
- CN-2711 Yellow
- CN-2712 Green
- CN-2713 Blue
- CN-2714 Grey
- CN-2715 Black

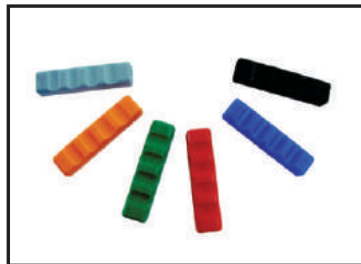

Silicone handle has available in six different colors and detachable by user.



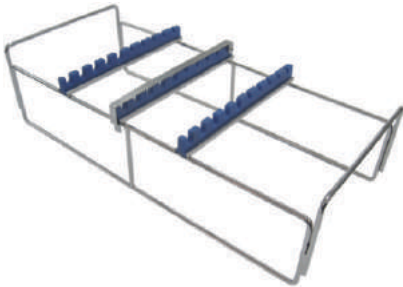

CN-31090

Rack, for endoscopy
Holds 10 endoscopic instruments
Fits into a 1/1 size 20 cm deep container

Wire basket 1/1 50 mm
Container 1/1 200 mm
Silicone mat 520 x 230 mm

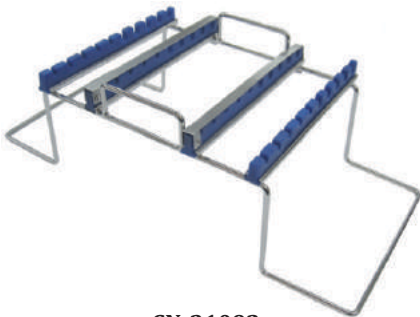
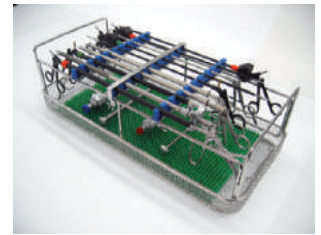
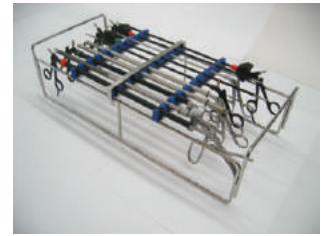

CN-31092

Rack, for arthroscopy
Holds 20 arthroscopy punches
Fits into a 1/1 size 20 cm deep container

Wire basket 1/1 50 mm
Container 1/1 200 mm
Silicone mat 440 x 230 mm

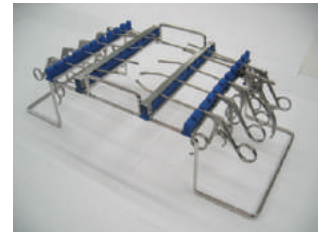

CN-31094

Rack, for Kerrison
Holds 10 Kerrison punches
20 cm deep container

Wire basket 1/2 50 mm
Wire basket 1/1 50 mm
Container 1/2 200 mm
Container 1/1 200 mm

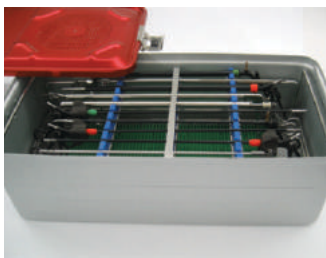



CN-2716
Holder for identification labels
50 x 35 x 13 mm



CN-2717
Disposal stamp
40 x 35 x 9 mm
Requested number or letter must be informed during the order



CN-2691
Storage stand
390 x 85 x 153 mm



- CN-2560 RED
- CN-2561 BLUE
- CN-2562 GREEN
- CN-2563 YELLOW
- CN-2564 GREY
- CN-2565 BLACK



- CN-2570
- CN-2571
- CN-2572
- CN-2573
- CN-2574
- CN-2575

Coloured identification labels Engraved to your specification

Grey coloured recommended for use in Sterrad.
Color fading By effect of Hydrogen Peroxide Gas Plasma on other colors.



CN-2569
Information board with clip

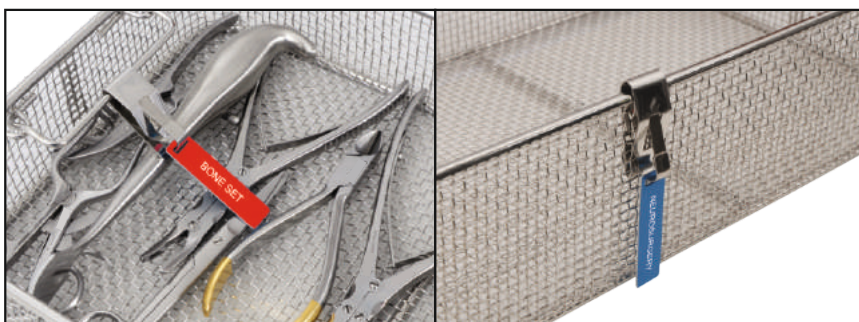



CN-2600 40 X 5 X 15 mm
DIVIDER (use with CN-2601 and CN-2602)



CN-2601 23 cm
CN-2602 47 cm
Sliding rails with securing screws



CN-2604 23 cm
CN-2605 47 cm
Limiting bar, with securing screws



CN-2607
Spiral holding device



CN-2609
Spiral holding device





CN-2615	11 mm
CN-2616	17 mm
CN-2617	23 mm
CN-2618	47 mm

Limiting bar



CN-2620
Spiral holding



CN-2622
Spiral holding



CN-2625
Spiral holding



Container System & Baskets

Classic & Bio-Barrier Model



ASEL TIBBİ ALETLER SAN. VE TİC. ANONİM ŞİRKETİ
ASEL MEDICAL INSTRUMENTS INDUSTRY AND COM. INC. CO.
19 Mayıs Mah. Kahvecioğlu Sk. No: 7/1 Tekkeköy / SAMSUN
Tel : 90 (362) 266 59 29 Fax : 90 (362) 266 59 39
www.aseltech.com.tr E-mail: info@aseltech.com.tr