



GENEL KATALOG
GENERAL CATALOG



*Online Katalog için web sitemizi ziyaret ediniz.
Please visit our website for **Online Catalog**.*

www.aseltech.com.tr



ASELTECH®

A SELTEC

ŞİRKET

ASEL TIBBİ ALETLER A.Ş.; sađlık sekt3r3nde ulusal ve uluslararası alanda hizmet veren tecr3beli, 3nc3, yatırımcı ve AR-GE faaliyetlerini ileri teknolojiler ile birleřtirerek alıřmaya 3nem veren bir aile řirketidir. T3rkiye'nin 3nde gelen 3reticileri ve dađıtıcılarından birisidir. Ana 3retim alanlarımız; sađlık kurum ve kuruluşlarının b3t3n branřları iin medikal ve cerrahi aletler, sterilizasyon konteyner sistemleri ve aksesuarları, sterilizasyon tel-sac sepetleri, silikon im ve aksesuarlar ve hastane terlikleridir.

ASEL TIBBİ ALETLER A.Ş. 3r3n tasarımından satıř sonrası servisine kadar 3retim her ařamasında Toplam Kalite Y3netimi Sistemi'ni sıkı sıkıya uygulamaktadır. Asel Tıbbi Aletler A.Ş. Uluslararası standartlarda kalite g3vencesi, toplumsal sorumluluk anlayıřı, evreyi koruma prensipleri ve m3řteri memnuniyeti ilkeleri dođrultusunda sađlık sekt3r3nde 3nc3 ve g3venilir kuruluş olarak hizmet vermeye devam edecektir.



COMPANY

ASEL MEDICAL DEVICES INC. is a family company who serve in national and international health sector that experienced, pioneer, investor and gives importance to the work by combining advanced technologies with R&D activities. It is one of the leading manufacturers and distributors in Turkey. Our main production sections; medical and surgical instruments, sterilization container systems and accessories, wire-steel sterilization baskets, silicon mats and hospital clogs for all branches of the health institutions and organizations.

ASEL MEDICAL DEVICES INC. considers to meticulously apply Total Quality Management System from design of the product to after sales service. Asel Medical Devices Inc. will continue to serve as leader and dependable companies in the health sector In accordance with quality assurance of international standards, social responsibility, principles of environment protection and customer satisfaction principles.



ASELTECH markalı üretilen cerrahi aletlerin ve diğer aparatların tümünde yüksek kalite için Alman paslanmaz çelik hammaddesi kullanılmaktadır.

German stainless steel raw materials used in all ASELTECH branded surgical instruments and other apparatus manufactured for high-quality.

HARDBLACK

Bu özellikteki aletler , aşınmaya karşı dayanıklı ve uzun süreli kullanıma uygundur. Aletler seramik kaplamadır , siyah renkli ve ışık yansımalarına karşı avantajlıdır. Paslanmaya karşı direnci yüksek ve ultra kesim özelliğine sahiptir.

This kind of instruments are durable against abrasion and eligible for long term use. The instruments are ceramic coated, in black color and advantageous against light reflection. It has high resistance to corrosion and ultra-cut feature.

DIAPOWDER

Hassas kesim özelliği yüksek olan ve aşınmaya karşı çok dayanıklı olan bu aletlerin işlev gören ağız ve uç kısımları elmas tozu ile kaplanmıştır.

The functioning mouth and tips of these items that have high precision cutting feature and highly resistant to abrasion are coated with diamond dust.

SuperCut

Tungisten karbür kaplı bu aletlerin çalışma ömrü uzundur. Kesici aletler hassas kesim özelliğine sahip olup, tutucu aletler ise aşınmaya karşı uzun ömürlüdür.

This kind of Tungsten Carbide coated instruments are long-lasting. The gripper instruments has a precision cutting feature, the gripper items are long lasting against to abrasion.

PerfectCut

İşlev gören kesici uçlar Tungisten karbür kaplıdır. Mikro tırtıklı şekilde kesici ağız kenarlarına sahiptir. Hassas doku kesme özelliğine göre üretilmiştir.

Acts carbide inserts from Tungis is covered. Micro serrated cutting edges Figure It has edges. It manufactured by sensitive tissue cutting property.

HARDMODEL

Aşınmaya karşı dayanıklı ve uzun ömürlü olan bu aletlerin uçları Tungisten karbür kaplıdır. Hassas kesim özelliğine sahip olup , yüzük kısımları sarı renktedir.

The tips of these durable against abrasion and long lasting itmes are coated by Tungsten Carbide. It has a precision cutting feature and ring portions are colored yellow.





GARANTİ

ASELTECH marka olarak teslim ettiğimiz tüm ürünler işçilik ve malzeme hatalarına karşı garantilidir. Garanti süresi içerisinde hatalı olduğu tespit edilen ve tarafımıza bildirilen tüm malzemeler yenileri ile değiştirilir.

GUARANTEE

All the products we deliver by ASELTECH brand are warranted against workmanship and material defects. The items which detected defective and informed us during the warranty period will be replaced with the new items.

KALİTE

ASEL TIBBİ ALETLER A.Ş, hammadde tedarigi, üretim, kalite kontrol, satış ve satış sonrası hizmetleri de kapsayan tüm kademelerinde, DIN EN ISO 9001-2000, DIN EN ISO 13485-2003 ve CE (93/42/EEC) standartlarına ve direktiflerine uygun olarak toplam kalite yönetim sistemini ödün vermeden uygulamaktadır.

QUALITY

ASEL MEDICAL DEVICES INC. considers to meticulously apply Total Quality Management System standards and the directives of DIN EN ISO 9001-2000, DIN EN ISO 13485-2003 and CE (93/42/EEC) for all stages including raw material procurement, production, quality control, sales and after-sales service.

AR-GE

AR-GE

Sahip olduğumuz ileri teknoloji üretim imkanları sayesinde, mevcut ürünlerin geliştirilmesi ve yeni tasarlanan ürünlerin nihai ürün olarak üretilmesini amaçlayan çalışmalarımız firmamızca aralıksız devam etmektedir.

R&D

It continues uninterrupted to improve our existing products and manufacture new designed products with the high-tech manufacturing opportunities we owned.





CERRAHİ EL ALETLERİ ÜRETİM ALANLARIMIZ

- Genel Cerrahi
- Jinekoloji
- Kalp Damar Cerrahi
- Göğüs Cerrahi
- Beyin Cerrahi
- KBB
- Plastik ve Rekonstrüktif Cerrahi
- Ortopedi
- Kemik Cerrahi
- El Cerrahisi
- Atroskopik Cerrahi
- Müşteri Talepleri Doğrultusunda
Özel Tasarım Cerrahi Aletler

SURGICAL INSTRUMENTS PRODUCTION BRANCHES

- General Surgery
- Gynecology
- Cardiovascular Surgery
- Thoracic Surgery
- Neurosurgery
- ENT
- Plastic and Reconstructive Surgery
- Orthopedics
- Bone Surgery
- Hand Surgery
- Athroscopic Surgery
- In Line with Customer Demand
Custom Design Surgical Instruments

AA

Muayene, Ölçme, Hazırlık ve Anestezi Aletleri
Diagnostic, Measuring, Preperation and Anaesthesia Instruments

1-12



BB

Bıçaklar, Bistüri Sapları ve Dermatomlar
Knives, Scalpel Handles and Dermatomes

13-26



BC

Makaslar
Scissors

27-96



BD

Pensetler
Forceps

97-132

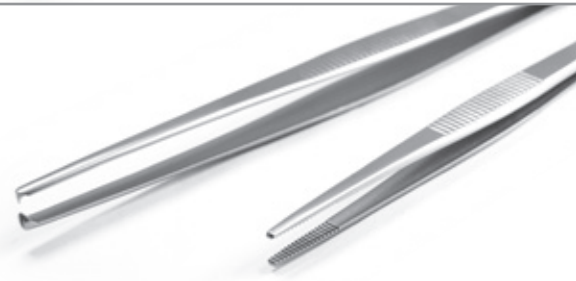

BE

Spanç, Doku ve Çamaşır Pensleri
Sponge, Tissue and Washing Forceps

133-160



BF

Portegüler ve Sütur Aletleri
Needle Holders and Suture Instruments

161-206



BG

Hemostatik Pensler, Diseksiyon Pensleri, Histerektomi Pensleri
Heamostatic Forceps, Dissecting Forceps, Hysterectomy Forceps

207-258



BH

Kalp Damar Cerrahi
Cardiovascular and Thoracic Surgery

259-298



BJ

Sondalar, Aspiratör Uçları, Trokarlar ve Biyopsi İğneleri
Probes, Suction Tubes, Trocars and Biopsy Needles

299-318



BK

El Ekartörleri, Huklar ve Spatulular
Retractors, Hooks and Spatulas

319-392



BM

Otomatik Ekartörler
Self-Retaining Retractors

393-436



GS

Genel Cerrahi
General Surgery

437-484



GU

Ürolojik Aletler
Genito-Urinary Instruments

485-506



GY

Jinekolojik Aletler
Gynaecological Instruments

507-576



CV

Kalp ve Damar Cerrahi
Cardiovascular and Thoracic Surgery

577-612

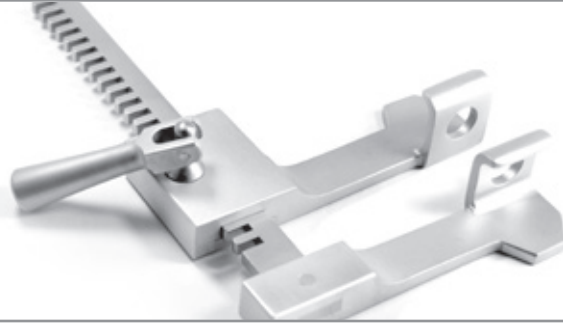

BN

Raspalar, Disektörler ve Elevatörler
Raspatories, Dissectors and Levers

613-674



BP

Kemik Küretleri
Bone Curettes

675-694



BR

Kemik Pensleri, Ronjurları, Makasları ve Pançları
Bone Holding Forceps, Rongeurs, Scissors and Punches

695-730



BS

Ronjurlar
Rongeurs

731-744



NS

Beyin Cerrahi
Neurosurgery

745-792



OS

Ortopedik Cerrahi
Orthopedic Surgery

793-828



AN

Anatomi, Amputasyon ve Otopsi Aletleri
Instruments for Anatomy, Amputation and Post Mortem

829-836



DE

Dermatoloji
Dermatology

837-842



MC

Mikroskopi
Microscopy

843-846



ES

Elektrocerrahi Aletleri
Electrosurgical Instruments

847-854



BW

Taslar, Böbrek Tasları, Sterilize Pensleri
Bowls, Kidney Trays, Sterilizing Forceps

855-858



A-Z

Türkçe - İngilizce Alfabetik İndeks
Turkish - English Alphabetical Index

861-890

0-9

Sayısal İndeks
Numerical Index

891-915

İÇİNDEKİLER
CONTENTS

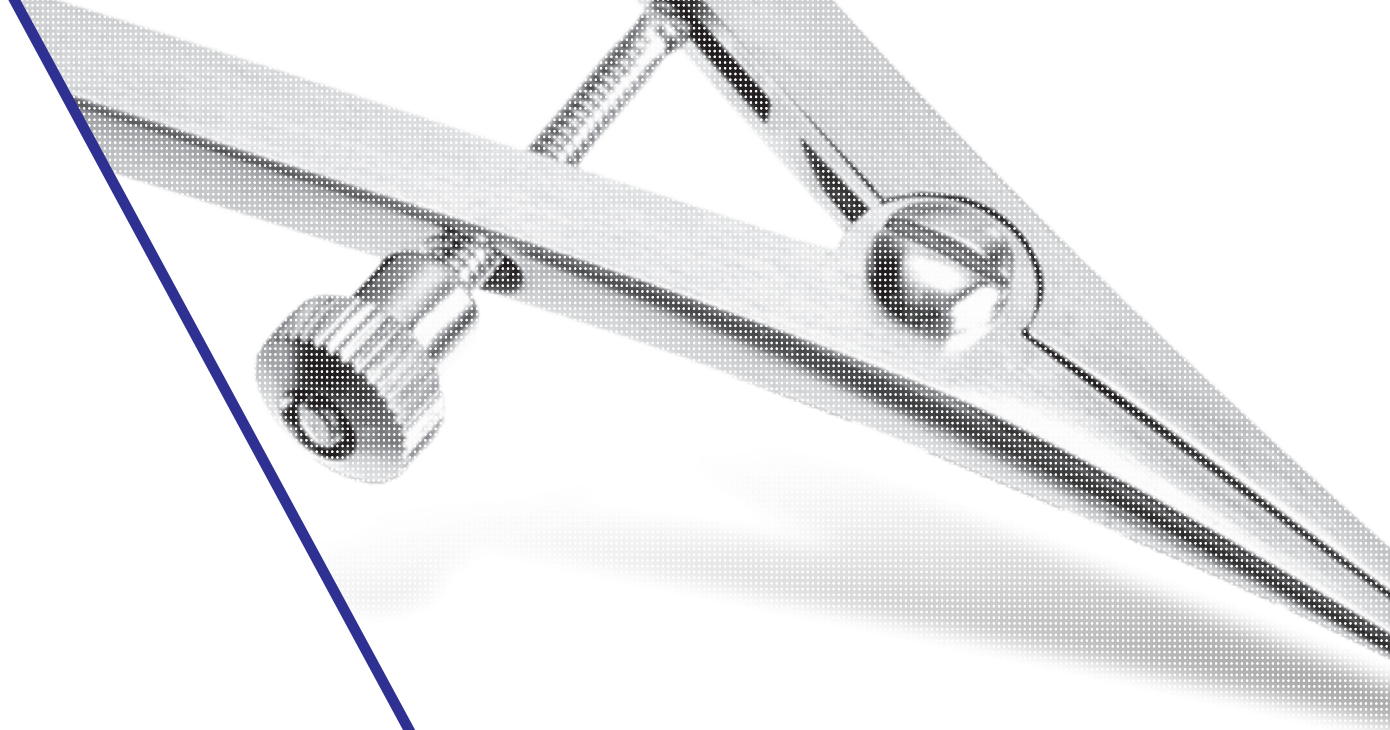

AA

Muayene, Ölçme, Hazırlık ve Anestezi Aletleri
Diagnostic, Measuring, Preperation and Anaesthesia Instruments



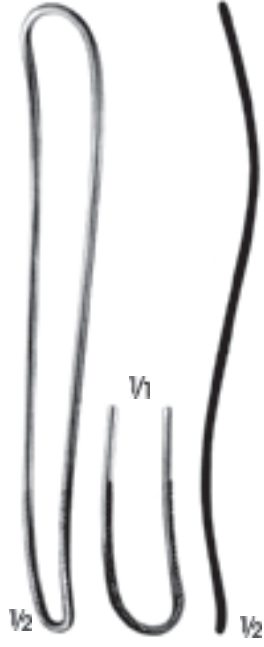

FRENZEL
BK-8210
16.5 cm



BRÜNINGS
BK-8208
19 cm



BK-8205
14.5 cm



BK-8206
14 cm



BUCHWALD
BK-8207
18 cm



V1

**SCHMID
BM-1245**
Ağız açıcı, ayarlanabilir
Mouth opening, adjustable



V2

**HEISTER
BM-1290**
Ağız açıcı
Mouth gag
13 cm



V2

BV-2200
Tahta ağız açıcı
Mouth gag wooden
14 cm



V2

BM-1260
Ağız açıcı
Mouth gag
12.5 cm



V2

**FERGUSSON-ACKLAND
BM-1250**
Ağız açıcı
Mouth gag
14.5 cm



V2

BM-1255
Ağız açıcı
Mouth gag
16 cm



V2

**ROSER-KÖNIG
BM-1265**
Ağız açıcı
Mouth gag
18.5 cm





BC-2912
Düz/Straight



BC-2914
Eğri/Curved



BC-2900
Düz/Straight
9.5 cm



BC-2901
Eğri/Curved
9.5 cm



BC-2902
Eğri/Curved
10.5 cm

BC-2912 - BC-2914
Hassas makaslar
Delicate scissors
9 cm

BC-2900
BC-2901 - BC-2902
Tırnak makasları
Nail Scissors



BC-2904
Tırnak makası
Nail scissors
9 cm

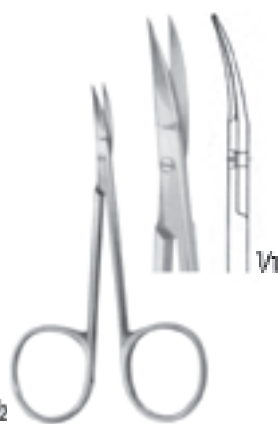

BC-2903
Tırnak makası, hassas
Nail scissors, delicate
9 cm



BC-2905
Bebek tırnak makası
Baby nail scissors
8.5 cm



BC-2906 - BC-2909
Tırnak makasları
Nail Scissors



BC-2906
Düz/Straight
9 cm



BC-2907
Eğri/Curved
9 cm



BC-2908
Eğri/Curved
10 cm



BC-2909
Eğri/Curved
11 cm



BR-8800
Tırnak makası
Nail cutter
13.5 cm



V1



BR-8801
Tırnak makası
Nail cutter
14.5 cm



V1



BP-3815
Tırnak törpüsü
Nail file
15 cm





AA-2006 - AA-2030
Altıgen saplı
laringel aynalar
Laryngeal mirrors with
hexagonal handle
18 cm



AA-2106 - AA-2130
Laringel aynalar
Laryngeal mirrors
12 cm



AA-2140
Ayna sapı
Mirror handle
11 cm



AA-2150
Ayna sapı
Mirror handle
10.5 cm



AA-2152
Ø 12 mm



AA-2154
Ø 14 mm



MICHEL
AA-2152 - AA-2154
Rinoskopik aynalar
(Değiştirilebilir aynalar)
Rhinoscopic mirrors,
with interchangeable mirror inserts
25 cm



AA-2006
AA-2106
Fig. 000
Ø 6 mm



AA-2008
AA-2108
Fig. 00
Ø 8 mm



AA-2010
AA-2110
Fig. 0
Ø 10 mm



AA-2012
AA-2112
Fig. 1
Ø 12 mm



AA-2014
AA-2114
Fig. 2
Ø 14 mm



AA-2016
AA-2116
Fig. 3
Ø 16 mm



AA-2018
AA-2118
Fig. 4
Ø 18 mm



AA-2020
AA-2120
Fig. 5
Ø 20 mm



AA-2022
AA-2122
Fig. 6
Ø 22 mm



AA-2024
AA-2124
Fig. 7
Ø 24 mm

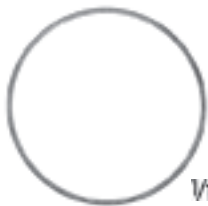

AA-2026
AA-2126
Fig. 8
Ø 26 mm

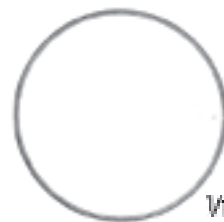

AA-2028
AA-2128
Fig. 9
Ø 28 mm

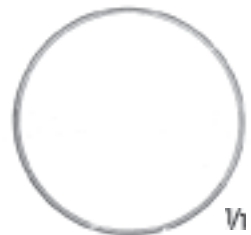

AA-2030
AA-2130
Fig. 10
Ø 30 mm



AA-2272
Nöroşürüji için özel kumpas
Caliper, special for neurosurgery
12.5 cm



AA-2265
Kumpas/Caliper
Ölçme 150 mm
Measuring 150 mm
23 cm



AA-2273
Kumpas/Caliper
Ölçme 100 mm
Measuring 100 mm
13 cm



AA-2460
Açı ölçer
Finger goniometer



AA-2210 - AA-2250
Cetveller/Rulers

- AA-2210** 10 cm
- AA-2215** 15 cm
- AA-2220** 20 cm
- AA-2230** 30 cm
- AA-2250** 50 cm



BN-9583
Meme markörü, dişli
Mamilla marker, toothed
Ø 33 mm



BN-9584
Meme markörü, dişli
Mamilla marker, toothed
Ø 38 mm



BN-9585
Meme markörü, dişli
Mamilla marker, toothed
Ø 42 mm



BN-9586
Meme markörü, dişli
Mamilla marker, toothed
Ø 48 mm





HEYWOOD-SMITH
BE-2620
21.5 cm



BE-2015
Yeni doğanlar için
For infants



BE-2020
Çocuklar için
For children



BE-2025
Yetişkinler için
For adults



MAGILL
BE-2015 15 cm
BE-2020 20 cm
BE-2025 25 cm
Kateter uygulama pensleri
Catheter introducing
forceps

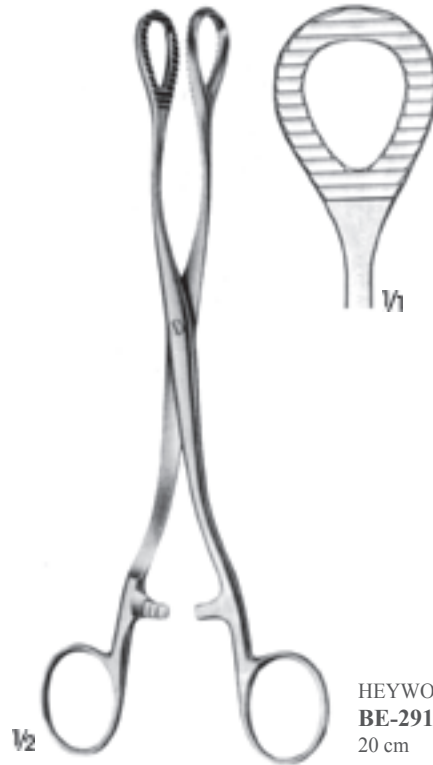

HEYWOOD-SMITH
BE-2911
20 cm

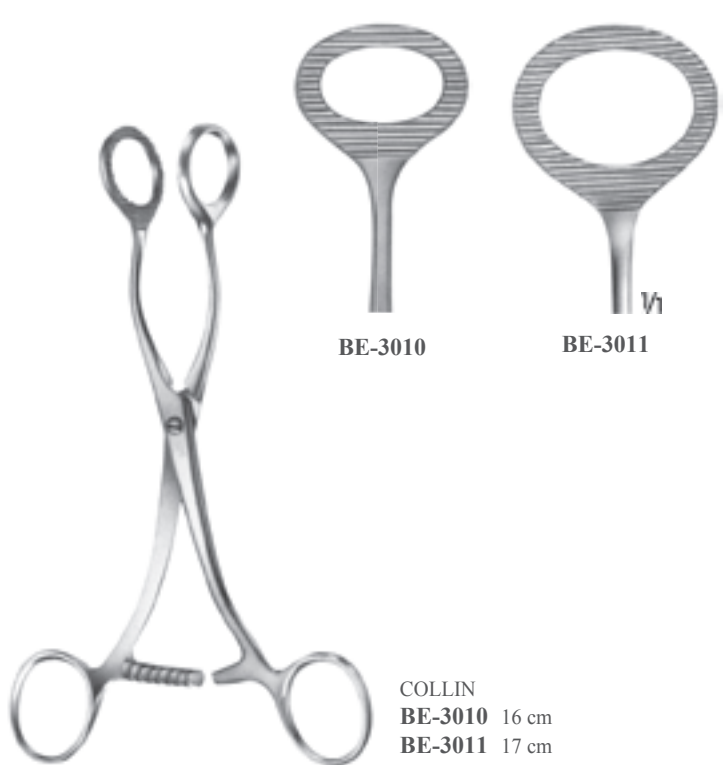

BE-3010

BE-3011

COLLIN
BE-3010 16 cm
BE-3011 17 cm



BE-2100
Düz/Straight



BE-2101
Eğri/Curved

BE-2100 - BE-2101
Pansuman pensleri
Dressing forceps
22 cm



BE-2200
Düz/Straight



BE-2201
Eğri/Curved

ULRICH
BE-2200 - BE-2201
Spanç pensleri
Sponge forceps
26.5 cm



BE-1900
Düz/Straight



BE-1901
Eğri/Curved

GROSS
BE-1900 - BE-1901
Pansuman pensleri
Dressing forceps
20 cm



BE-1902
Düz/Straight



BE-1903
Eğri/Curved

GROSS
BE-1902 - BE-1903
Spanç pensleri
Sponge forceps
20 cm



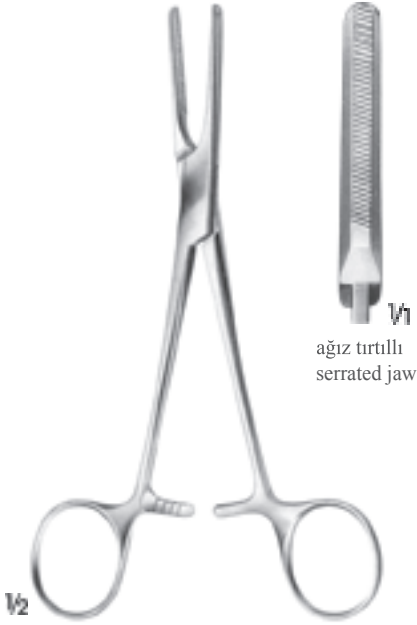

W2

BG-7100

Tüp klempi, sert tüpler için
Tubing clamp forceps, heavy pattern
16.5 cm

W1
ağız tırtıllı
serrated jaw



W2

BG-7105

Tüp klempi
Tubing clamp
18 cm

W1



BG-7102 - BG-7104

Tüp klempleri
Tubing clamps



BG-7102
15.5 cm

BG-7103
18.5 cm

BG-7104
20 cm

W1



BG-6815 15 cm

BG-6818 18 cm

BG-6819 19 cm

BG-6820 20 cm

Tüp klempleri
Tubing clamps

W1

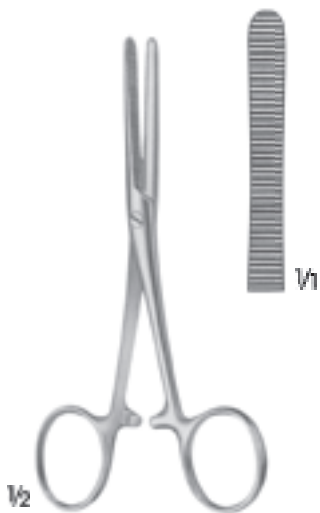

PEAN
BG-2433
Tüp klemp
Tubing clamp forceps
12.5 cm



KLINIKUM BERLIN
BG-2505
Uzun kilit mesafeli tüp klemp
Tubing clamp
heavy pattern, long ratchet,
therefore passage adjustable
14.5 cm



BG-7101
Sert tüpler için, tüp klemp
Tubing clamp forceps
16.5 cm



SAUERBRUCH
BG-7055
Tutma pensi, tampon ve çamaşırlar için
Pick-up forceps for used tampons and
dressings
55 cm



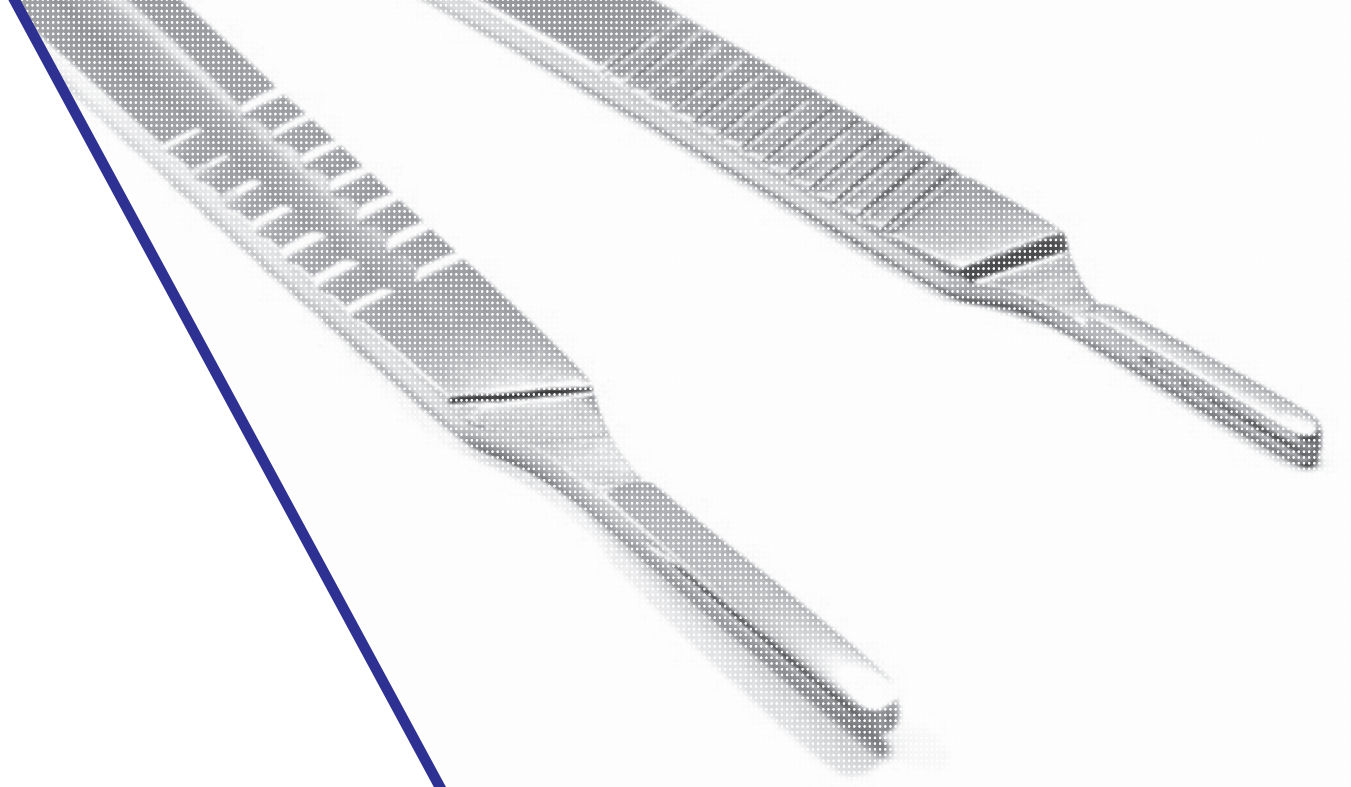

BB

Bıçaklar, Bistüri Sapları ve Dermatolar
Knives, Scalpel Handles and Dermatomes



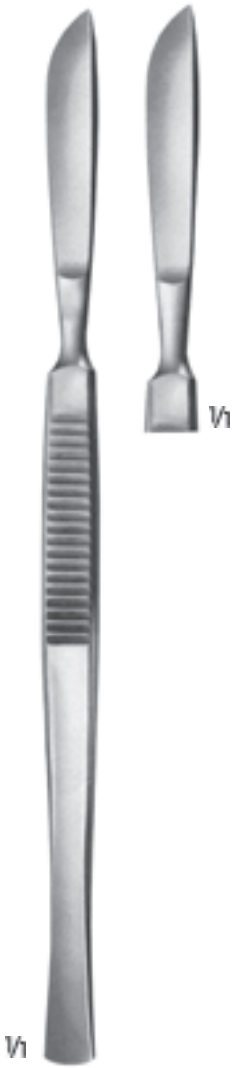

**BERGMANN
BB-1920**
14 cm



BB-1910 - BB-1915
13 cm



BB-1910 BB-1911 BB-1912 BB-1913 BB-1914 BB-1915



W

BB-1900 - BB-1909



BB-1900
14 cm



BB-1901
15 cm



BB-1902
15.5 cm



BB-1903
16.5 cm



BB-1904
17 cm



BB-1905
17.5 cm



BB-1906
18 cm



BB-1908
18 cm



BB-1907
16 cm



BB-1909
Tenotom/Tenotome
17 cm



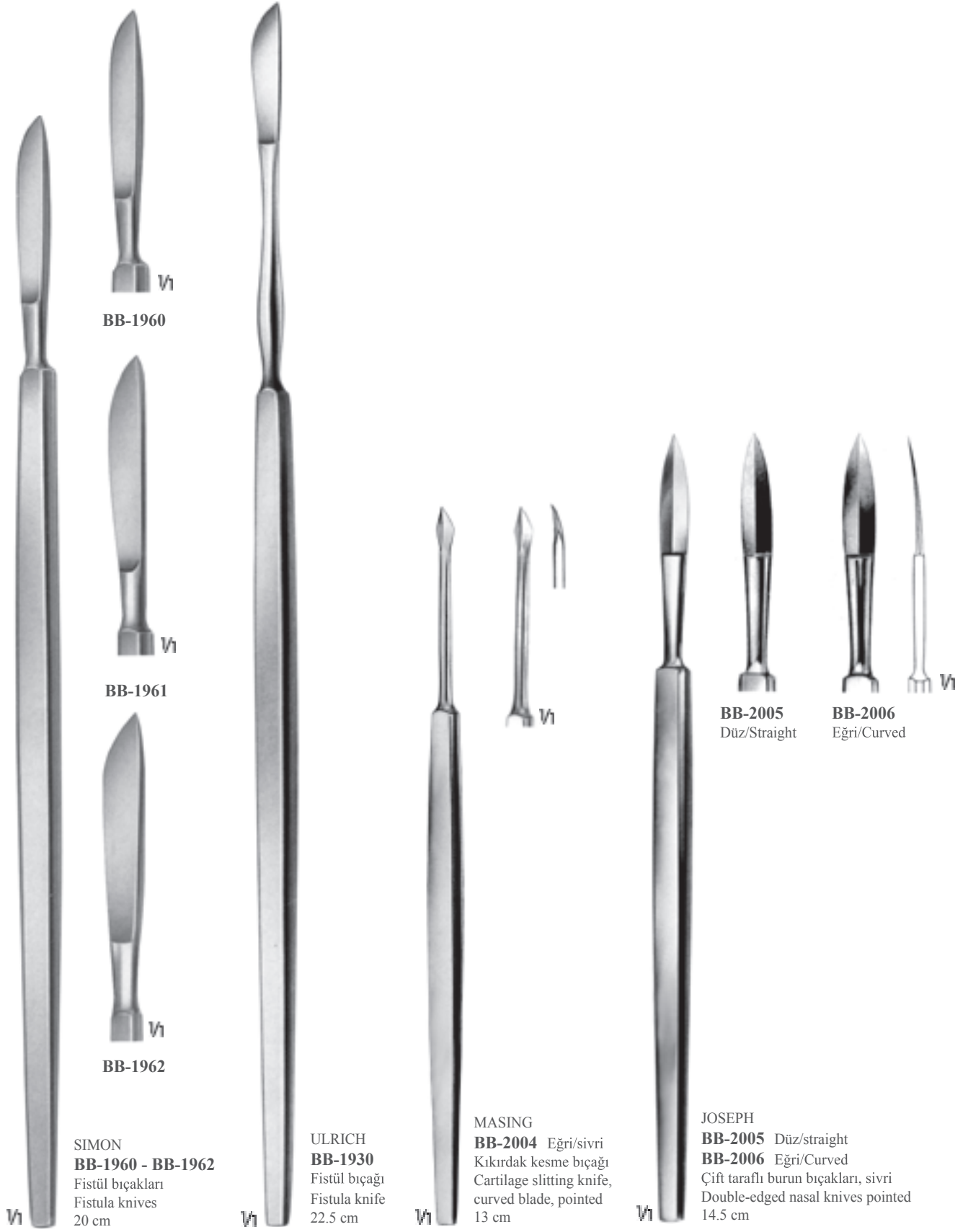

BB-1960

BB-1961

BB-1962

SIMON
BB-1960 - BB-1962
Fistül bıçakları
Fistula knives
20 cm

ULRICH
BB-1930
Fistül bıçağı
Fistula knife
22.5 cm

MASING
BB-2004 Eğri/sivri
Kıkırdak kesme bıçağı
Cartilage slitting knife,
curved blade, pointed
13 cm

BB-2005
Düz/Straight

BB-2006
Eğri/Curved

JOSEPH
BB-2005 Düz/straight
BB-2006 Eğri/Curved
Çift taraflı burun bıçakları, sivri
Double-edged nasal knives pointed
14.5 cm



FOWLER
BB-1970
Tonsil bıçak
Tonsil knife
20 cm



ABRAHAM
BB-2000
Tonsil bıçak
Tonsil knife
21.5 cm



OLIVECRONA
BB-1975
Trigeminal bıçak
Trigeminal knife
20.5 cm



BB-1935
Trigeminal bıçak
Trigeminal knife
23 cm





Çift taraflı kesme
Double cutting



CATLIN
BB-2125
Amputasyon bıçak
Amputation knife
Ağız Uzunlukları
Length of blade
16 cm

Çift taraflı kesme
Double cutting



LISTON
BB-2130 13 cm
BB-2135 16 cm
BB-2140 19 cm
BB-2145 22 cm
Amputasyon bıçakları
Amputation knives
Ağız uzunlukları
Length of blade
12 cm

Çift taraflı kesme
Double cutting



BB-2111
Interosseöz bıçak
Interosseous knife
Ağız uzunlukları
Length of blade
11 cm



LANGENBECK
BB-2112
Kanat bıçak
Flap knife
Ağız uzunlukları
Length of blade
12 cm



BB-2155

BB-2160

LANGENBECK
BB-2155 - BB-2160
Rezeksiyon bıçakları
Resection knives
Length of blade
Ağız uzunlukları
5.5 cm



BB-2120
Falanks bıçak
Phalangeal knife
Ağız uzunlukları
Length of blade
10.5 cm



BB-2165
Periost bıçak
Periosteum knife
Ağız uzunlukları
Length of blade
6.5 cm



SCHINK
BB-2300
Sadece dermatom
Only dermatome
30 cm



BB-2340
Sadece yedek bıçak
Spare blade only



BB-2335
Sadece cilt doğrultma
plakası
Skin straightening plate
only



SILVER
BB-2325
Cilt nakil dermatomu, bıçaksız
Dermatome skin transplant,
bladeless
19 cm



REHN
BB-2223
23.5 cm





1/2

**HUMBY
BB-2350**
Cilt nakil dermatomu, bıçaksız
Volume transport dermatome,
bladeless
36.5 cm



1/2

**WATSON
BB-2310**
Cilt nakil dermatomu, bıçaksız
Volume transport dermatome,
bladeless
30 cm



1/2

**COBBETT
BB-2330**
Cilt nakil dermatomu, bıçaksız
Volume transport dermatome,
bladeless
31.5 cm



1/2

**BRAITHWAITE
BB-2315**
Cilt nakil dermatomu, bıçaksız
Volume transport dermatome,
bladeless
31.5 cm





BB-1122



BB-1125



BARRÉ
BB-1121
25 cm



BB-1210
No. 4
13.5 cm



BB-1212
No. 4
13.5 cm



BB-1110
No. 3
12.5 cm



BB-1112
No. 3
12.5 cm



BB-1117
No. 7
16 cm

BARRÉ
BB-1122 - BB-1125
No. 3XL
Sol el için/For left hand
25 cm



BB-1120



V1

BB-1118 - BB-1120
No. 3
22.5 cm



V1

BB-1218
No. 4
22.5 cm



V1

BB-1223
No. 8
13 cm



V1

BB-1224
No. 4
14.5 cm



V1

BB-1115
No. 3 L
21 cm



V1

BB-1215
No. 4 L
21.5 cm





BB-1104
33 cm



BB-1103
20 cm



CASPAR
BB-1102
18 cm



BB-1101
15.5 cm



BB-1100
13.5 cm



V1



BB-1105
No. 3
21 cm

V1



V1



LANDOLT
BB-1106
Bistüri sapı bayonet
kare saplı
Scalpel handle,
bayonet-shaped square shank
21 cm

V1



LANDOLT
BB-1107
Bistüri sapı bayonet
yuvarlak saplı
Scalpel handle, bayo-
net-shaped, round
25 cm



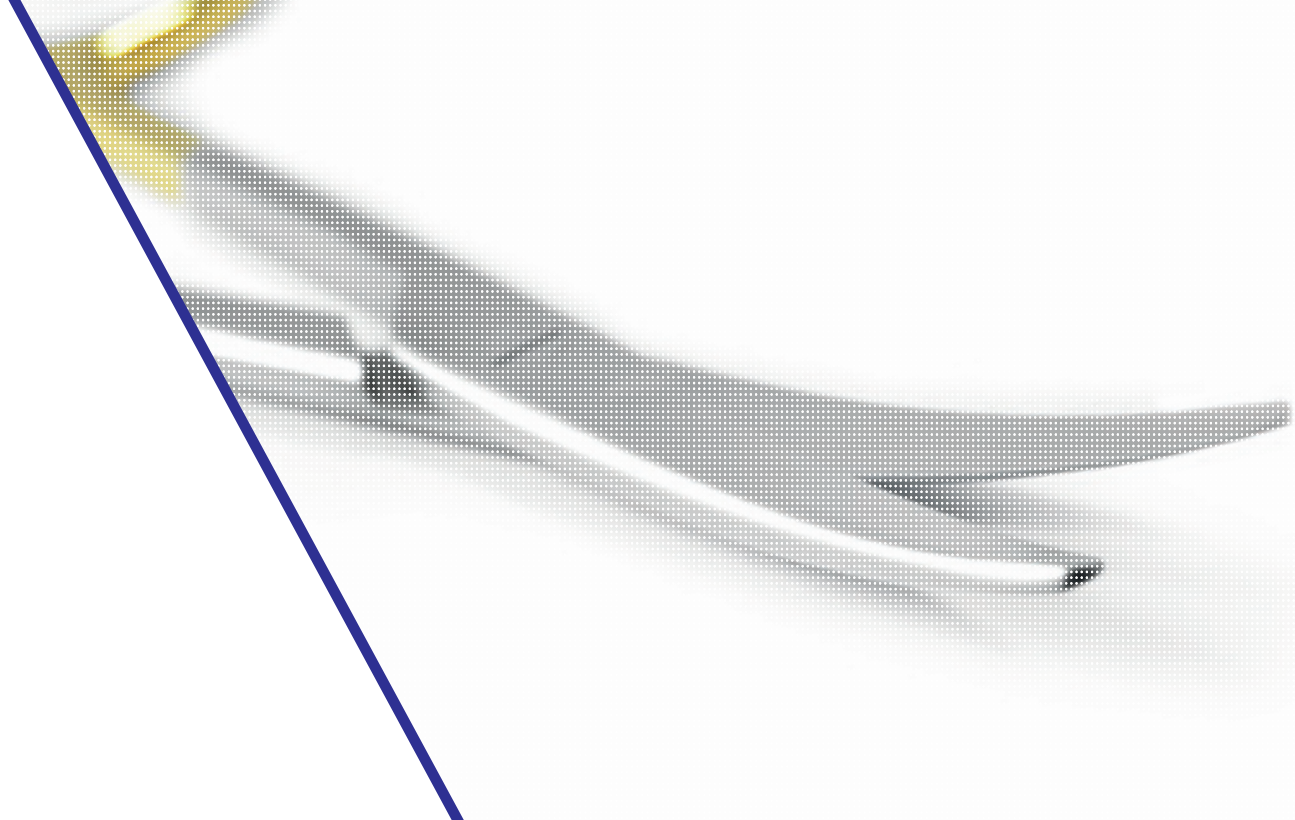

BC

Makaslar
Scissors

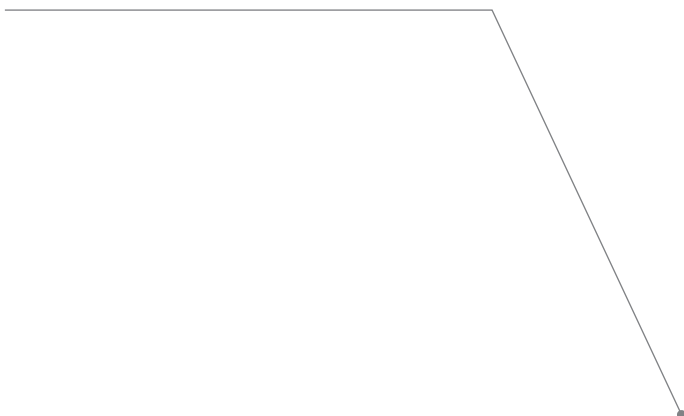



Düz Saplar ve çapraz tırtıl :
Sağlam kavrama özelliği sağlar.

Flat handles and cross serration:
Provides a solid grip.

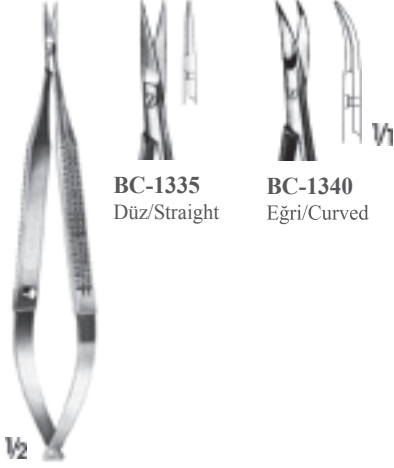

BC-1335
Düz/Straight

BC-1340
Eğri/Curved

BC-1335 - BC-1340
Mikro makaslar/Micro scissors
12 cm



VANNAS
BC-1350
Düz/Straight
Mikro makas/Micro scissors
12 cm



VANNAS
BC-1351
Mikro makas/Micro scissors
12 cm

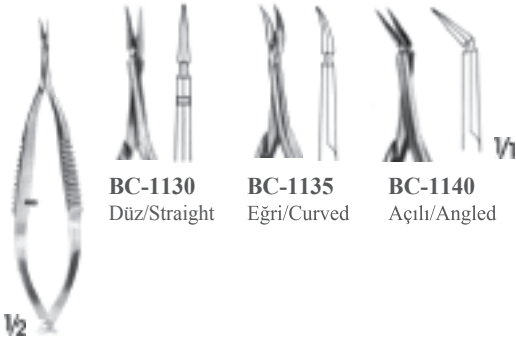

BC-1130
Düz/Straight

BC-1135
Eğri/Curved

BC-1140
Açılı/Angled

VANNAS
BC-1130 - BC-1140
Hassas/Delicate
8.5 cm



MC CLURE
BC-1145
Düz/Straight
Göz makası/Eye scissors
9.5 cm

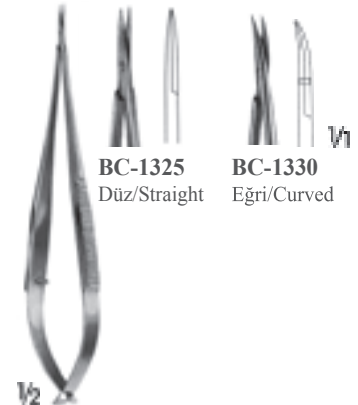

BC-1325
Düz/Straight

BC-1330
Eğri/Curved

BC-1325 - BC-1330
Göz makasları/Eye scissors
10.5 cm



VANNAS
BC-1352
Mikro makas/Micro scissors
Düz açılı/Angled on flat
12 cm



NOYES
BC-1355
Göz makası/Eye scissors
Düz/Straight
12.5 cm



BC-1360
Damar ucunu pürüzsüzleştirmek
için damar makası
Vein scissors for roughening
Vessel ends
13 cm

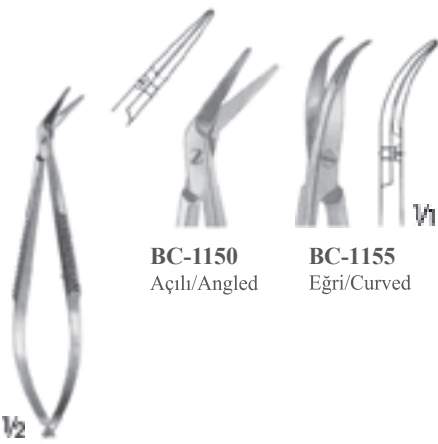

BC-1150
Açılı/Angled

BC-1155
Eğri/Curved

CASTROVIEJO
BC-1150 - BC-1155
Göz makasları/Eye Scissors
9.5 cm

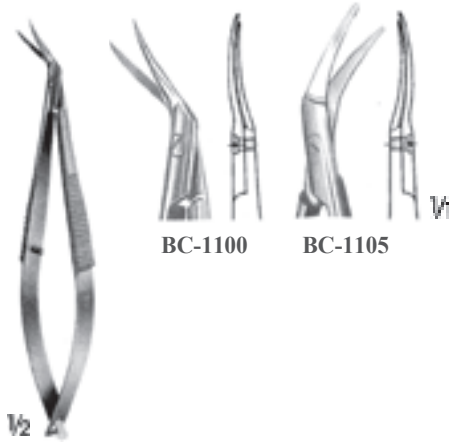

BC-1100

BC-1105

CASTROVIEJO
BC-1100 - BC-1105
Göz makasları/Eye scissors
11 cm



WECKER
BC-1110 Uçları sivri/Pointed-pointed
BC-1115 Sivri, künt, sağ/Pointed-blunt, right
BC-1120 Sivri, künt, sol/Pointed-blunt, left
BC-1125 Uçları künt/Blunt-blunt
Göz makasları/Eye scissors
11 cm





Düz Saplar ve çapraz tırtıl :
Sağlam kavrama özelliği sağlar.

Flat handles and cross serration:
Provides a solid grip.



YASARGIL
BC-1395
Düz/Straight



JACOBSON
BC-1396
Eğri/Curved



BC-1896
Ultra hassas bleyd
Ultra delicate blade



BC-1996
Hassas bleyd
Delicate blade



BC-1897
Ultra hassas bleyd
Ultra delicate blade



BC-1997
Hassas bleyd
Delicate blade

BC-1395 - BC-1396
18.5 cm

BC-1896 - BC-1996
Düz/Straight
16.5 cm

BC-1897 - BC-1997
Eğri/Curved
16.5 cm



BC-1365
Düz/Straight



BC-1370
Eğri/Curved



BC-1380
Düz/Straight



BC-1381
Eğri/Curved



BC-1390
Düz/Straight



BC-1391
Eğri/Curved

BC-1365 - BC-1370
16 cm

VANNAS
BC-1380 - BC-1381
16 cm

MİLLESI
BC-1390 - BC-1391
Çift ağız tırtıllı
Both jaws serrated
16 cm

Yuvarlak Saplar

- Parmaklar arasında istenildiği şekilde döndürmeye izin verir.
- Sağlam veya oyulmuş saplardan dolayı her bir alette optimum denge sağlar.

Round Handle

- Allows rotation between the fingers as required
- Due to carved and strong handle, each instrument provides optimum balance.



BC-1640
Mikro ligatür makası
Micro ligature scissors
18 cm



Sivri/Sharp
1 bleyd tırtılı/1 blade serrated

Sütür 6-0 ve daha küçükler için - 8-0 ve daha küçükler için
For suture material 6-0 and smaller - 8-0 and smaller



BC-1631 - BC-1635
Mikro makaslar
Micro scissors
18 cm



BC-1631
Sivri/Sharp



BC-1632
Sivri/Sharp



BC-1635
1 bleydi küre uclu
1 blade probe pointed



BC-1610 - BC-1612
14.5 cm



BC-1610
Düz/Straight



BC-1611
Eğri/Curved



BC-1612
Eğri/Curved
Mikro diseksiyon makası
Micro dissecting scissors



BC-2296 - BC-2397
16.5 cm



BC-2296
Eğri/Curved
Ultra hasas bleyd
Ultra delicate blade



BC-2396
Düz/Straight
Hassas bleyd
Delicate blade



BC-2397
Eğri/Curved
Hassas bleyd
Delicate blade





Düz sap
Flat handle

Yuvarlak sap
Round handle

25°

45°

60°

90°

125°

Ultra hassas bleyd
Ultra delicate blade



BC-1825
BC-2225



BC-1845
BC-2245



BC-1860
BC-2260



BC-1890
BC-2290



BC-1895
BC-2295

Hassas bleyd
Delicate blade



BC-1925
BC-2325



BC-1945
BC-2345



BC-1960
BC-2360



BC-1990
BC-2390



BC-1995
BC-2395

Ince bleyd,
tek tarafı küre uçlu bleyd
Fine blade,
with 1 probe pointed blade



BC-2025
BC-2425



BC-2045
BC-2445



BC-2060
BC-2460



BC-2090
BC-2490



BC-2095
BC-2495

Ince bleyd
Fine blade



BC-2125
BC-2525



BC-2145
BC-2545



BC-2160
BC-2560



BC-2190
BC-2590



BC-2195
BC-2595

BC-1825 - BC-2195
16.5 cm

BC-2225 - BC-2595
16.5 cm

Kavrama yüzeyini artıran hafif plastik tutamak :

- Kramp oluşturmeyen, doğal tutma pozisyonu ve duyarlılık sağlar.
- Yuvarlak tutma kesiti aletin kolay ve düzgün rotasyonunu sağlar. Böylelikle uygulama ve çalışma alanı genişler.
- Pimli tutma profili güvenli tutmayı garanti eder.
- Ergonomik, hafif plastik sap yorulmadan optimum kullanım sağlar.

Lightweigh plastic handles to increase grip surface :

- Provides cramp free, natural holding positions and sensitivity
- Round cross-section of the instrument provides an easy and smooth rotation.Expands the working and application area.
- Retention profile with pin ensures safe griping.
- Ergonomic, light weight plastic handle provides fatigue free,optimal usage.



MÜLLER
BC-1705
Sivri/Sharp
17 cm



MÜLLER
BC-1706
Sivri/Sharp
17 cm



MÜLLER
BC-1700 - BC-1704
12 cm



BC-1700
Sivri/Sharp



BC-1701
Sivri/Sharp



BC-1702
Sivri/Sharp
Künt/Blunt



BC-1703
Künt/Blunt



BC-1704
Sivri/Sharp
Top uc/Ball pointed





BC-3883
Sivri/Sharp



BC-3885
Sivri/Sharp



BC-3887
Künt/Blunt



BC-3889
Künt/Blunt



BC-2917
Düz/Straight



BC-2918
Eğri/Curved

STVENS
BC-3883 - BC-3889
Diseksiyon makasları/Dissecting scissors
11.5 cm

BC-2917 - BC-2918
Diseksiyon ve şaşılık makasları
Dissecting- and strabismus scissors
11.5 cm



BC-2921
Düz/Straight



BC-2922
Eğri/Curved

BC-2921 - BC-2922
Hassas makaslar/Delicate scissors
11.5 cm



BC-2943
Düz/Straight



BC-2945
Eğri/Curved

JOSEP
BC-2943 - BC-2945
Hassas makaslar/Delicate scissors
15 cm

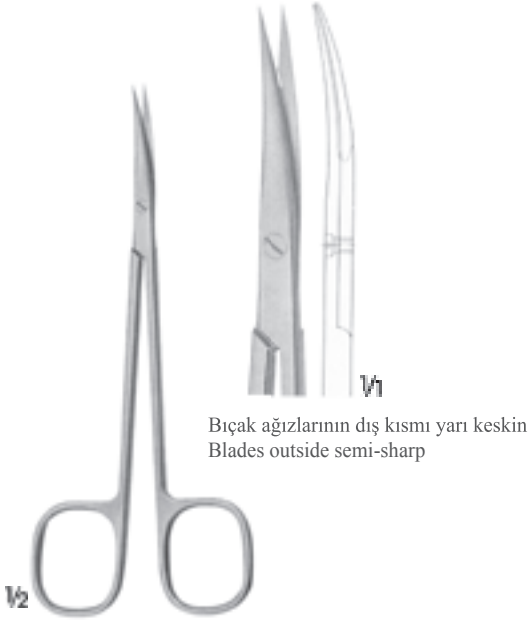

Bıçak ağzlarının dış kısmı yarı keskin
Blades outside semi-sharp

BC-2949
Diseksiyon, sinir makası
Nerve dissecting scissors
14 cm



BC-3895
Düz/Straight
13.5 cm

BC-3896
Eğri/Curved
13.5 cm

BC-3897
Eğri/Curved
15 cm

RAGNELL
BC-3895 - BC-3897
Diseksiyon ve cilt altı için özel düz uçlar
Special flat points for dissecting and
undermining the skin



REYNOLDS-JAMESON
BC-3875
Vasküler makas/Vascular scissors
14 cm



BC-3903
Düz/Straight

BC-3905
Eğri/Curved

METZENBAUM
BC-3903 - BC-3905
Diseksiyon makasları/Dissecting scissors
14.5 cm



BC-2913
Düz/Straight



BC-2915
Eğri/Curved



BC-2919
Düz/Straight



BC-2920
Eğri/Curved

BC-2913 - BC-2915
10.5 cm

BC-2919 - BC-2920
12 cm



BC-2910
Düz/Straight



BC-2911
Eğri/Curved



BC-2912
Düz/Straight



BC-2914
Eğri/Curved

BC-2910 - BC-2911
9 cm

BC-2912 - BC-2914
9.5 cm



BC-2925
Düz/Straight



BC-2929
Eğri/Curved



BC-2933
Düz/Straight



BC-2934
Eğri/Curved

BC-2925 - BC-2929
11.5 cm

BC-2933 - BC-2934
12 cm



BC-2923
Sivri/Sharp



BC-2926
Sivri/Sharp



BC-2930
Sivri/Sharp
Künt/Blunt



BC-2931
Sivri/Sharp
Künt/Blunt



BC-2932
Sivri/Sharp
Yan Eğri
Curved to side

BC-2923 - BC-2932
11 cm



KELLY
BC-2946 - BC-2947
17.5 cm



BC-2946
Düz/Straight
Sivri/Sharp



BC-2947
Eğri/Curved
Sivri/Sharp

V1

V2



BC-2935 - BC-2937
12 cm



BC-2935
Düz/Straight
Sivri/Sharp



BC-2936
Eğri/Curved
Sivri/Sharp



BC-2937
Eğri/Curved
Künt/Blunt

V1



BC-2938 - BC-2941
13 cm



BC-2938
Düz/Straight
Sivri/Sharp



BC-2939
Eğri/Curved
Sivri/Sharp



BC-2940
Düz/Straight
Künt/Blunt



BC-2941
Eğri/Curved
Künt/Blunt

V1

V2



JOSEPH
BC-2942 - BC-2944
15 cm



BC-2942
Düz/Straight
Sivri/Sharp



BC-2944
Eğri/Curved
Sivri/Sharp

V1



PERWITZSCHKY
BC-5302
1 bleydi küre uçlu eğri,
With 1 probe pointed blade, curved to side
10 cm

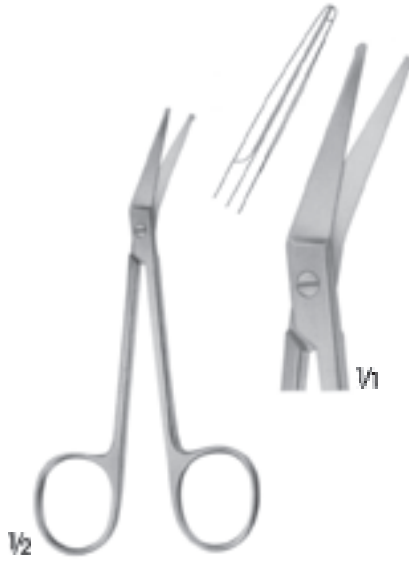

BC-5303
Yana doğru açılı
Angled to side
11.5 cm

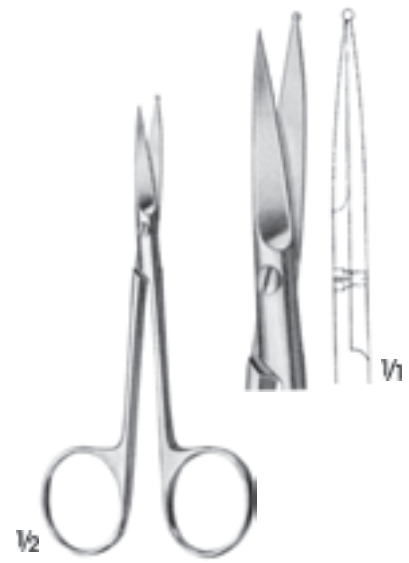

BC-5313
1 bleydi küre uçlu
With 1 probe pointed blade
12 cm



CHADWICK
BC-2950
11.5 cm

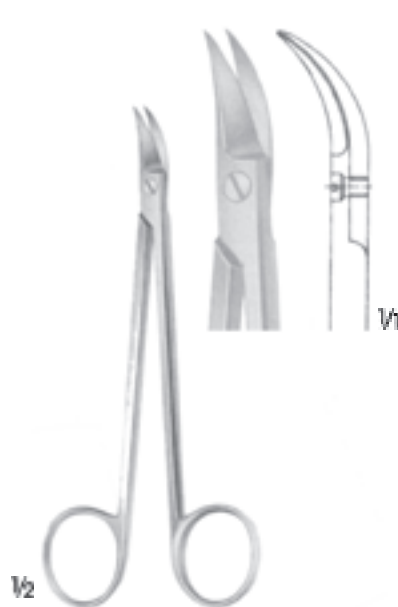

QUINBY
BC-2951
13 cm

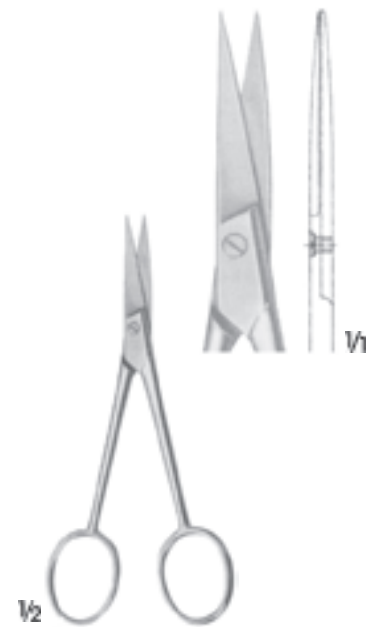

BC-2952
11 cm





V2

BC-5314

1 ucu problu
With 1 probe pointed blade
14.5 cm



V2

LOCKLIN

BC-5315

Tek ağız tırtıllı, yana açılı
Angled to side, one jaw serrated
15.5 cm



V2

LA GRANGE

BC-5310

Tek ağız tırtıllı
One jaw serrated
11 cm



V2

BC-5311

Tek ağız tırtıllı, yana açılı
Angled on flat, one jaw serrated
12.5 cm

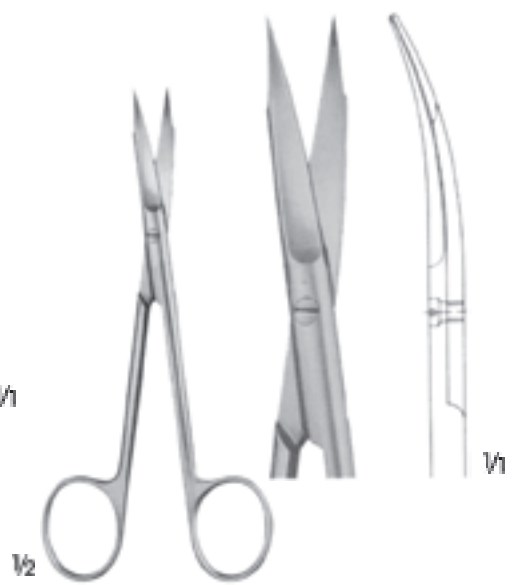

V2

BC-5312

Tek ağız tırtıllı, hassas
One jaw fine serrated
13 cm

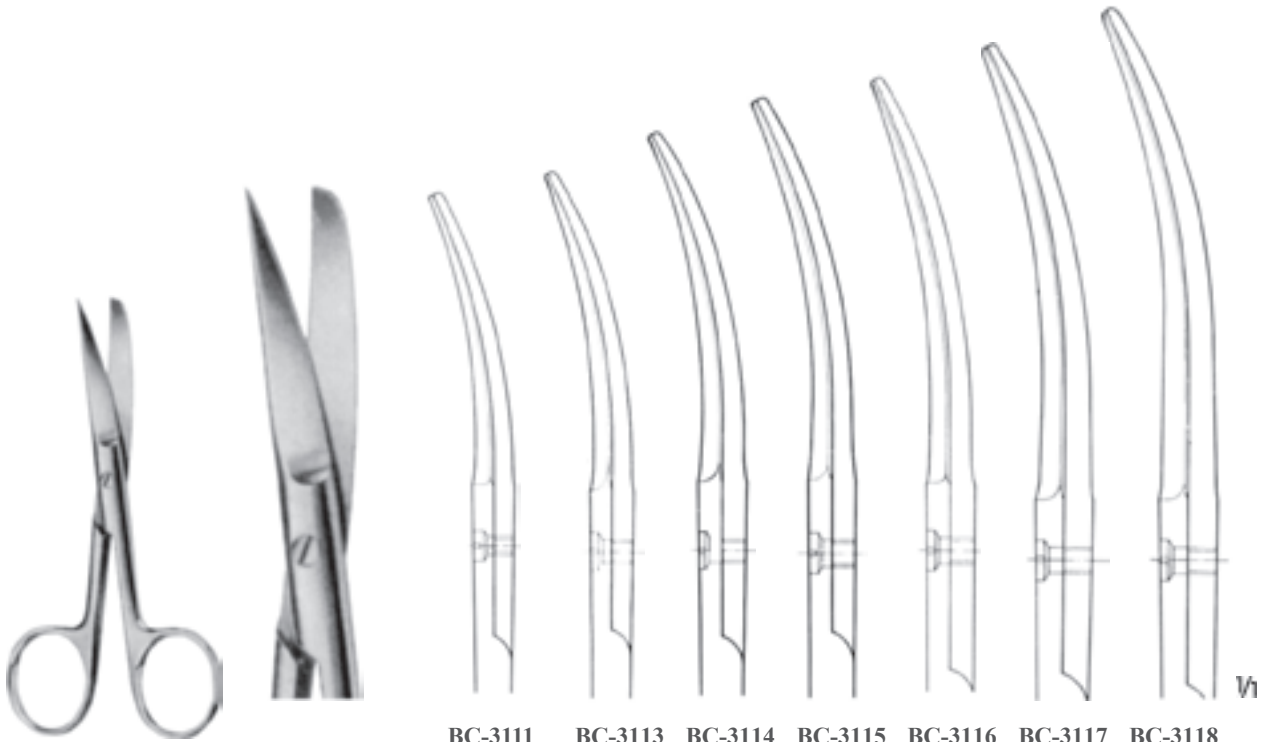

BC-3111 - BC-3118
Standart model/Standard patterns
Sivri-Künt/Sharp-Blunt
Eğri/Curved

BC-3111 11.5 cm **BC-3113** 13 cm **BC-3114** 14.5 cm **BC-3115** 15 cm **BC-3116** 16.5 cm **BC-3117** 17.5 cm **BC-3118** 18.5 cm

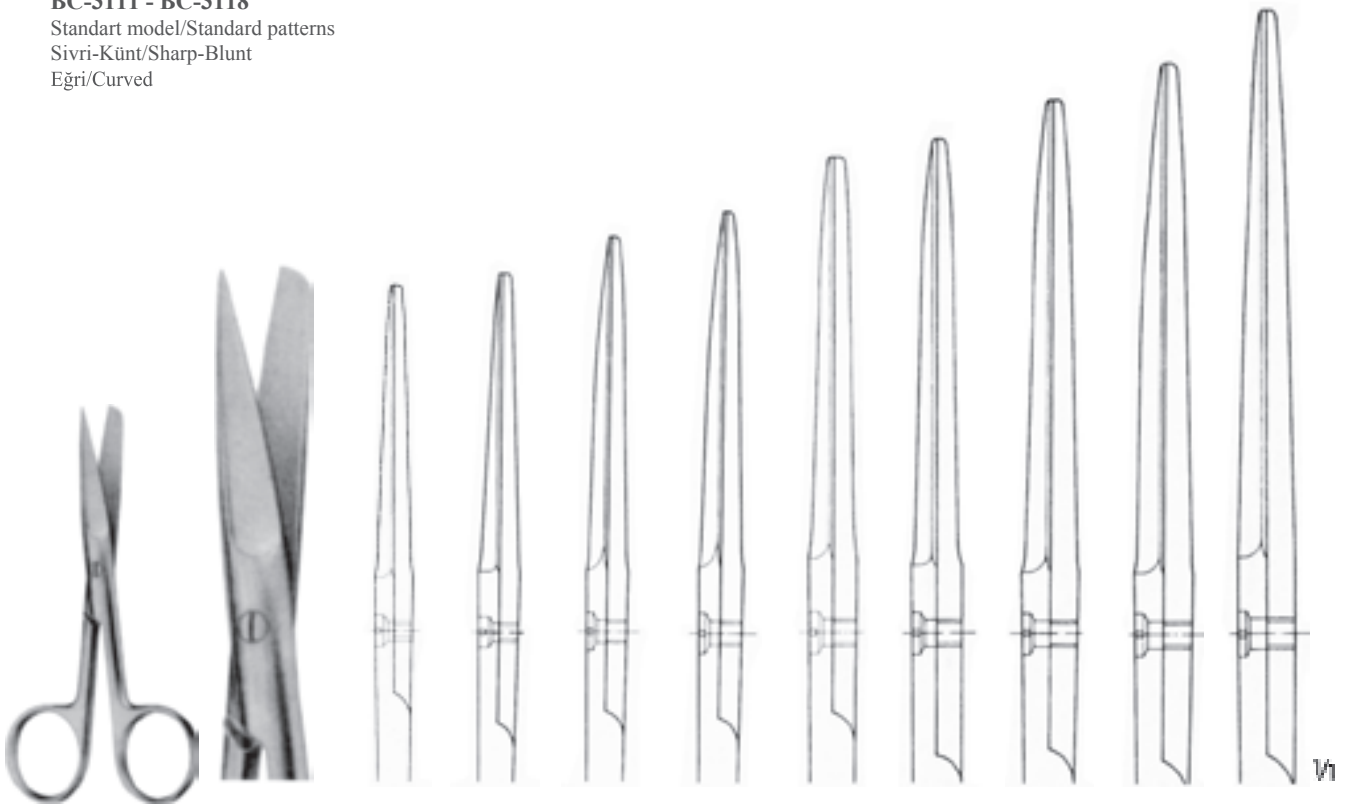

BC-3010 - BC-3020
Standart model/Standard patterns
Sivri-Künt/Sharp-Blunt
Düz/Straight

BC-3010 10.5 cm **BC-3011** 11.5 cm **BC-3013** 13 cm **BC-3014** 14.5 cm **BC-3015** 15 cm **BC-3016** 16.5 cm **BC-3017** 17.5 cm **BC-3018** 18.5 cm **BC-3020** 20 cm

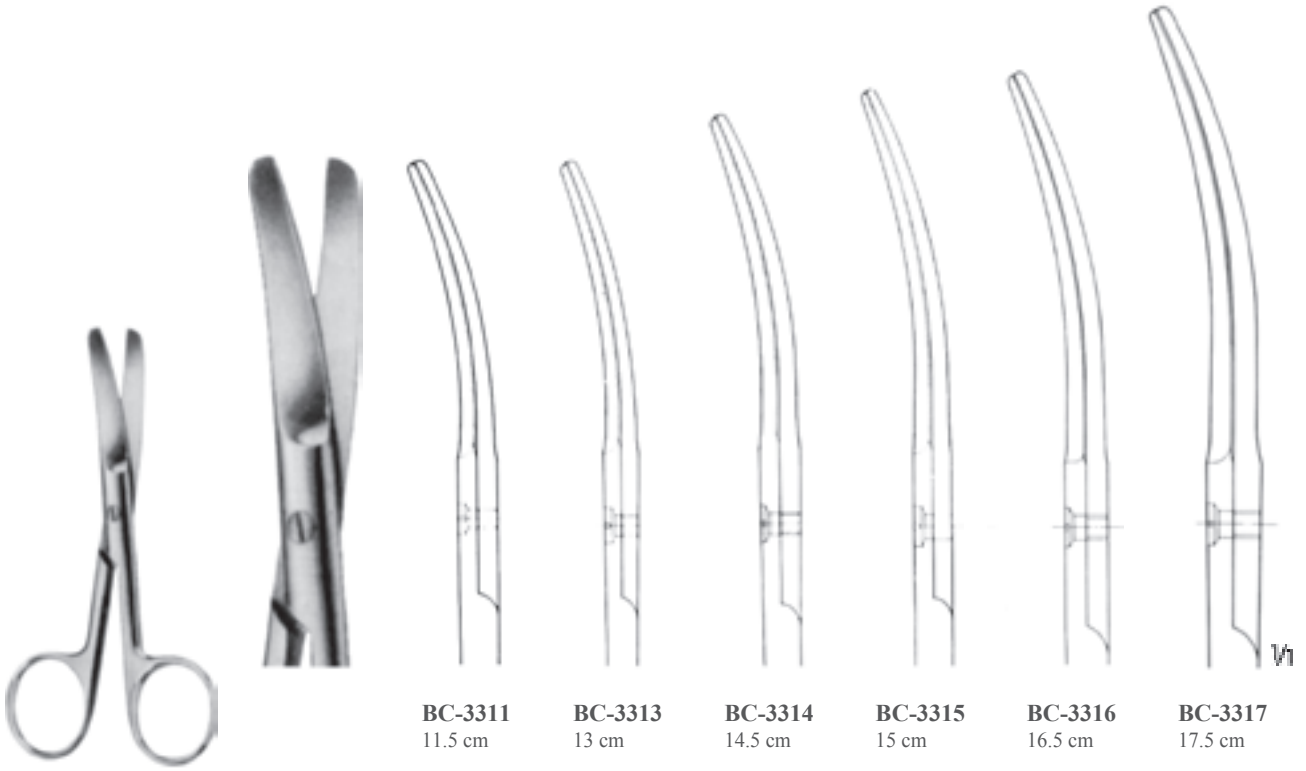

COOPER
BC-3311 - BC-3317
Standart model/Standard patterns
Künt/Blunt
Eğri/Curved

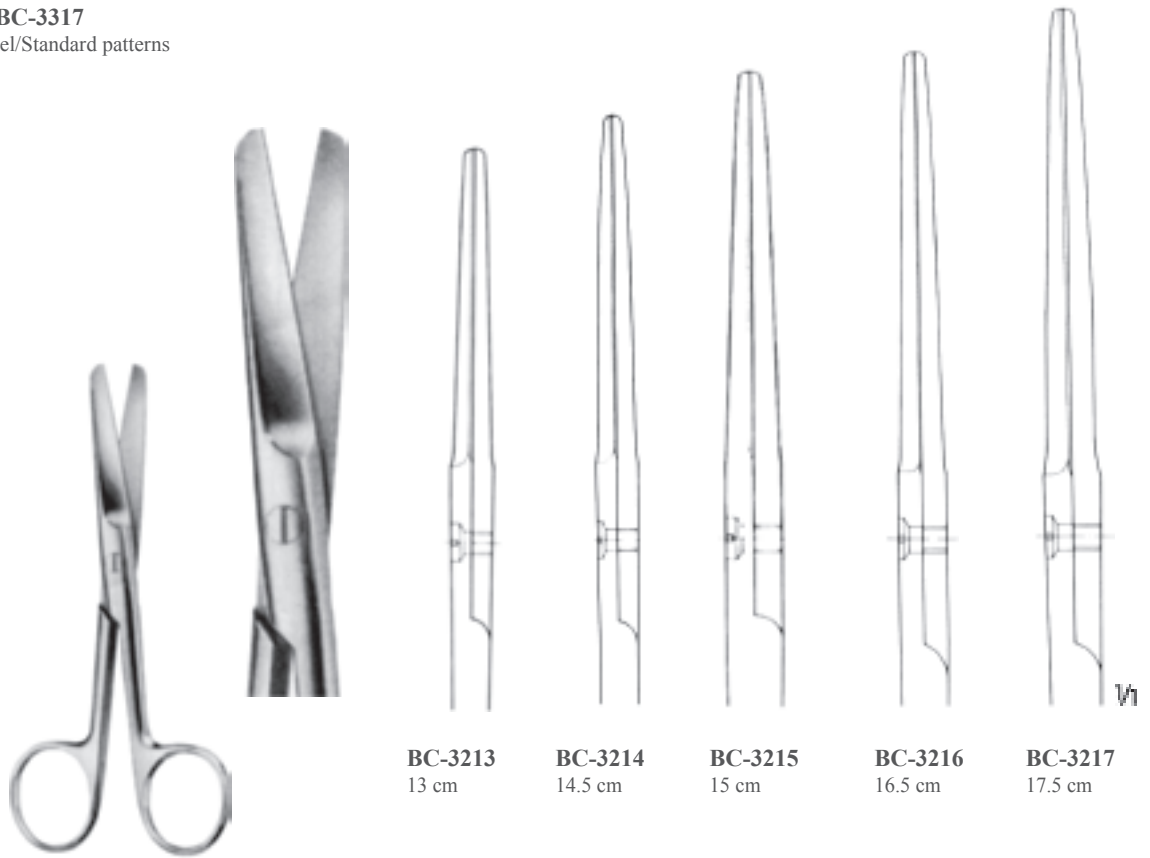

BC-3213 - BC-3217
Standart model/Standard patterns
Künt/Blunt
Düz/Straight



BC-3511 - BC-3515
Standart model/Standard patterns
Sivri/Sharp
Eğri/Curved



BC-3511 11.5 cm
BC-3513 13 cm
BC-3514 14.5 cm
BC-3515 15 cm



BC-3411 - BC-3416
Standart model/Standard patterns
Sivri/Sharp
Düz/Straight

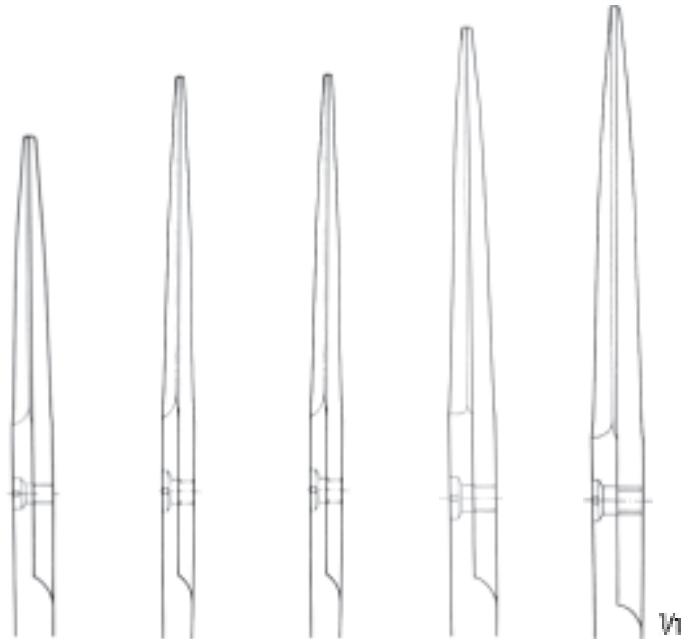

BC-3411 11.5 cm
BC-3413 13 cm
BC-3414 14.5 cm
BC-3415 15 cm
BC-3416 16,5 cm



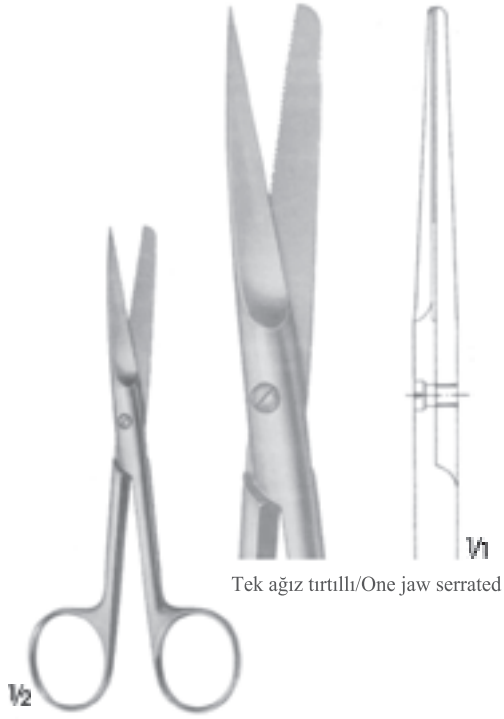

Tek ağız tırtıllı/One jaw serrated

BC-3800

Yara kenar makası/Scissors for wound edges
Sivri-Künt/Sharp-Blunt
Düz/Straight
13 cm

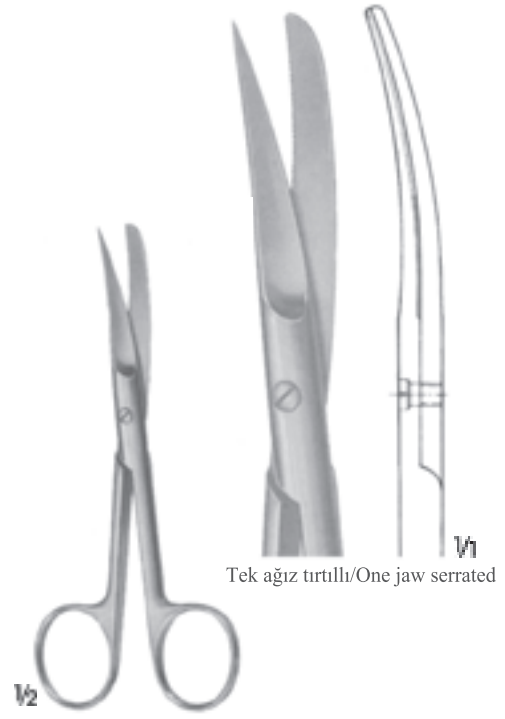

Tek ağız tırtıllı/One jaw serrated

BC-3801

Yara kenar makası/ Scissors for wound edges
Sivri-Künt/Sharp-Blunt
Eğri/Curved
13 cm

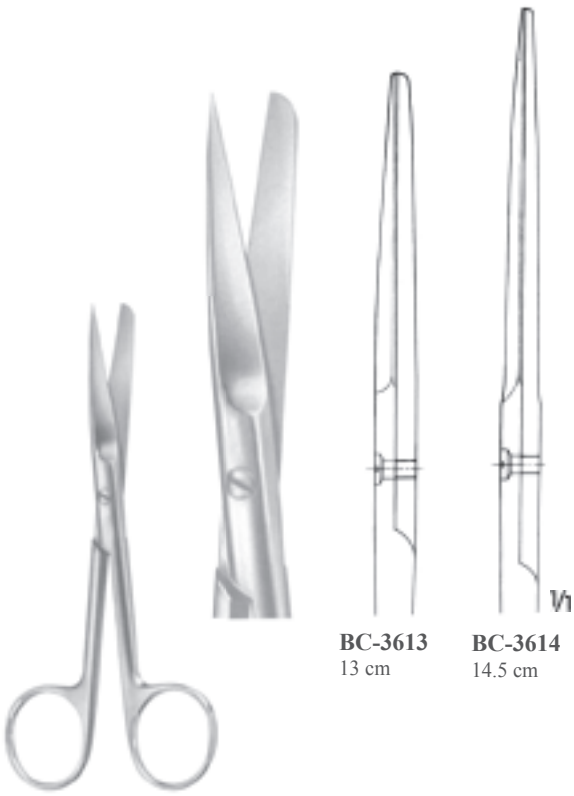

BC-3613
13 cm

BC-3614
14.5 cm

BC-3613 - BC-3614

Narin model/Slender patterns
Sivri-Künt/Sharp-Blunt
Düz/Straight

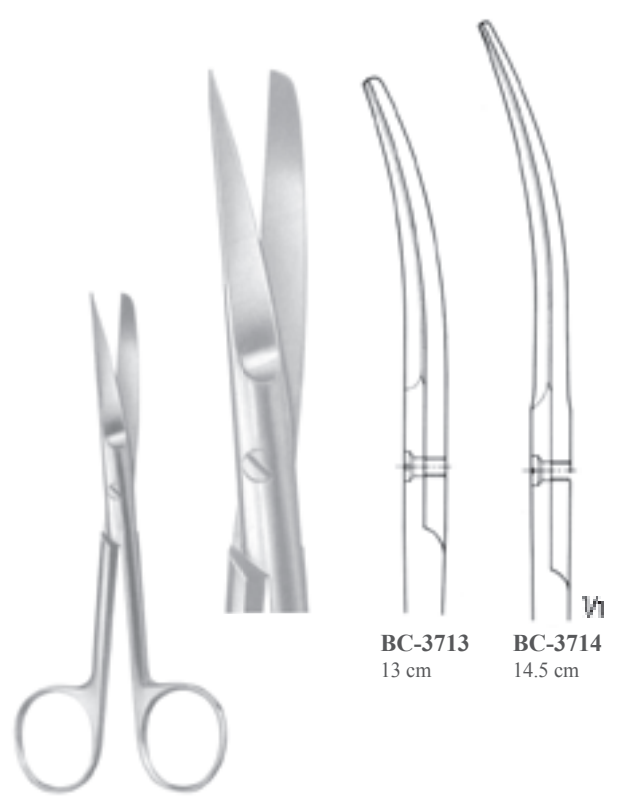

BC-3713
13 cm

BC-3714
14.5 cm

BC-3713 - BC-3714

Narin model/Slender patterns
Sivri-Künt/Sharp-Blunt
Eğri/Curved



DEAVER
BC-3810 - BC-3812
Cerrahi makaslar/Surgical scissors
14.5 cm



BC-3810
Sivri/Sharp
Künt/Blunt



BC-3811
Sivri/Sharp
Künt/Blunt



BC-3812
Künt/Blunt



SYSTRUNK
BC-5370
Sert doku makası/Nail splitting scissors
13 cm



BC-3813 - BC-3816
Inzisyon makasları/Incision scissors
Düz/Straight



BC-3813
13 cm



BC-3814
14.5 cm



BC-3816
16.5 cm





COTTLE
BC-3835
Bulldog makası/Bulldog scissors
11.5 cm



LITTLER
BC-3850
Diseksiyon makası ip kesici, delikli
Dissecting scissors, tips with eye suture
11.5 cm



KILNER
BC-2916
Hassas diseksiyon makası
Delicate dissecting scissors
11.5 cm



GRAEFE
BC-3825 Künt/Blunt
Diseksiyon makası/Dissecting scissors
10 cm

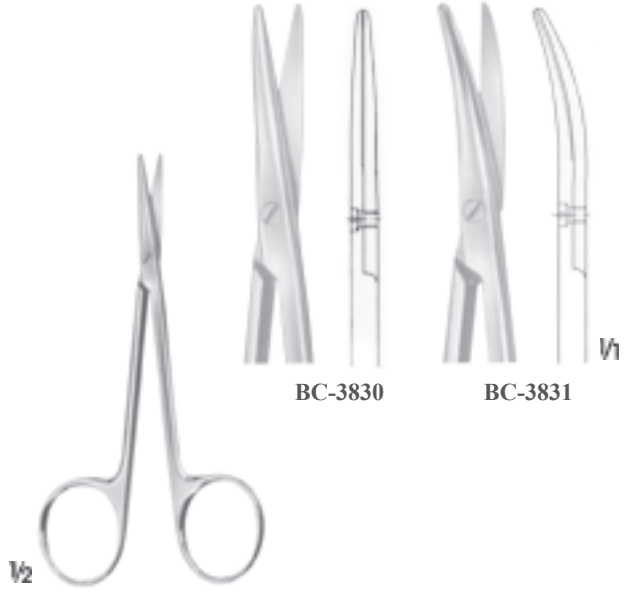

BC-3830 Düz/Straight
BC-3831 Eğri/Curved
Diseksiyon makasları
Dissecting scissors
11.5 cm



FOMON
BC-2953 - BC-2954
Alt yanal makaslar
Lower lateral scissors



BC-2953
Eğri/Curved
11.5 cm



BC-2954
Eğri/Curved
13.5 cm



LANDOLT
BC-2955
Enuklasyon makası
Enucleation scissors
12 cm

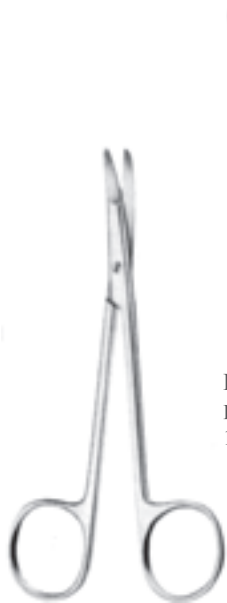

KILNER
BC-3855 - BC-3860
Diseksiyon ve cilt altı için özel düz uçlar
Special flat points for dissecting and
undermining the skin



BC-3855
Eğri/Curved
12.5 cm



BC-3860
Eğri/Curved
15 cm



COTTLE-MASING
BC-3840 - BC-3845
Plastik cerrahi makasları
Scissors for plastic surgery
10.5 cm



BC-3840
Sivri/Sharp



BC-3845
Künt/Blunt





Super Cut



STEVENS
BC-3894
Hassas diseksiyon makası
Delicate dissecting scissors
11 cm



BC-3892
Düz/Straight

BC-3893
Eğri/Curved

STEVENS
BC-3892 - BC-3893
Damar ve tendon makasları
Vascular and tendon scissors
10 cm

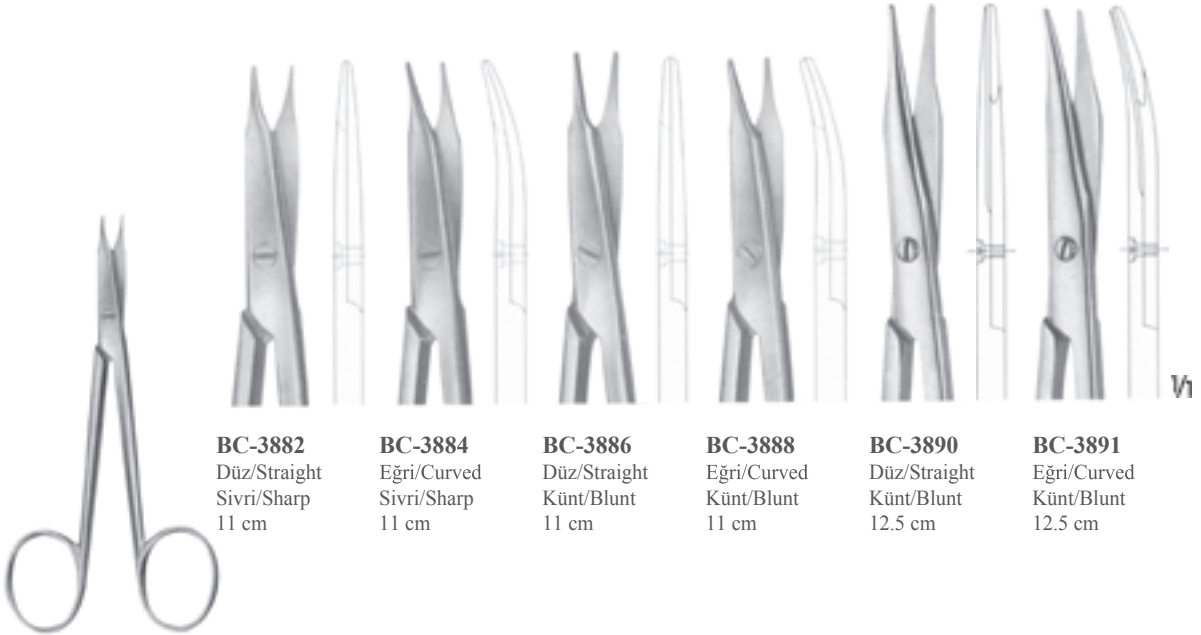

BC-3882
Düz/Straight
Sivri/Sharp
11 cm

BC-3884
Eğri/Curved
Sivri/Sharp
11 cm

BC-3886
Düz/Straight
Künt/Blunt
11 cm

BC-3888
Eğri/Curved
Künt/Blunt
11 cm

BC-3890
Düz/Straight
Künt/Blunt
12.5 cm

BC-3891
Eğri/Curved
Künt/Blunt
12.5 cm

STEVENS
BC-3882 - BC-3891
Damar ve tendon makasları
Vascular and tendon scissors

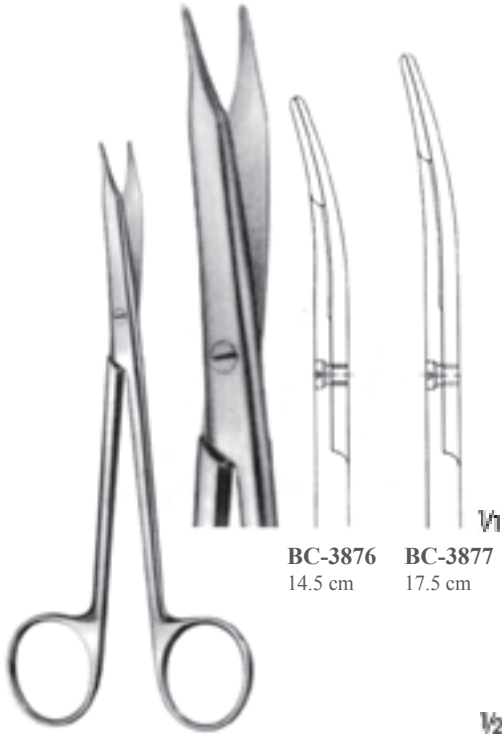

BC-3876
14.5 cm

BC-3877
17.5 cm

REYNOLDS
BC-3876 - BC-3877
Diseksiyon makasları
Dissecting scissors

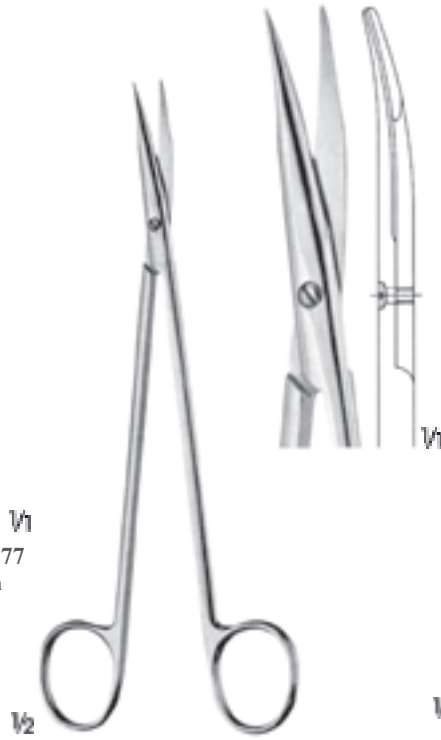

POTTS
BC-3865
Diseksiyon makası
Dissecting scissors
18 cm

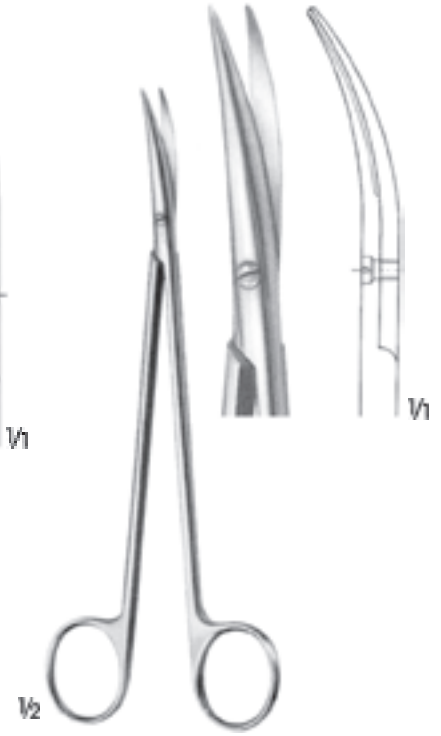

DE BAKEY
BC-3908
Arteriyotomi makası
Arteriotomy scissors
17.5 cm

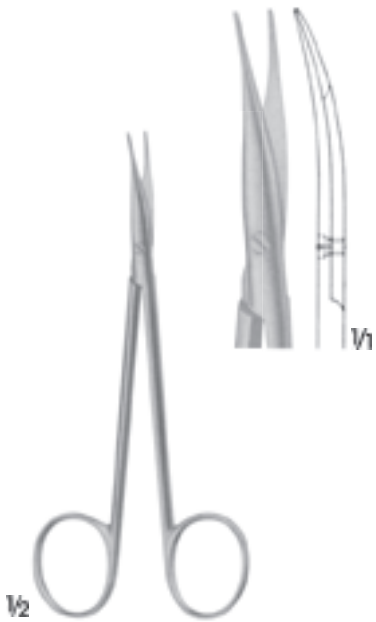

JAMESON-WERBER
BC-3870
Diseksiyon makası
Dissecting scissors
13 cm



JAMESON
BC-3871
Diseksiyon makası
Dissecting scissors
15 cm

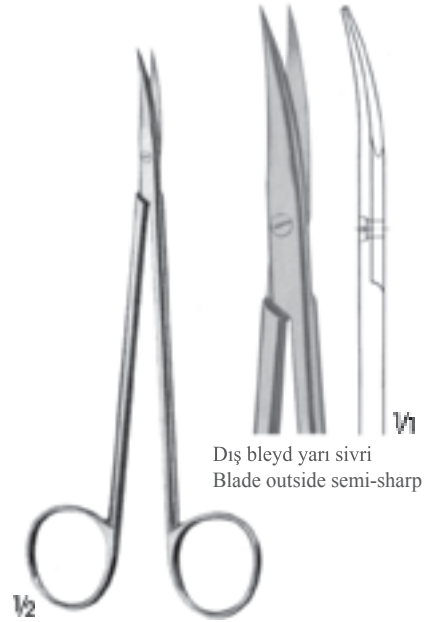

BC-2948
Sinir, diseksiyon makası
Nerve dissecting scissors
15 cm

Dış bleyd yarı sivri
Blade outside semi-sharp



BC-3906
Düz/Straight
16 cm



BC-3907
Eğri/Curved
16 cm



BC-3910
Çok hassas
Very delicate



BC-3911
Hassas
Delicate

METZENBAUM
BC-3906 - BC-3907
Diseksiyon makasları
Dissecting scissors

TÖNNIS-ADSON
BC-3910 - BC-3911
Diseksiyon makasları
Dissecting scissors
17.5 cm



BC-3900
Düz/Straight
Künt/Blunt



BC-3901
Eğri/Curved
Künt/Blunt



BC-3902
Düz/Straight



BC-3904
Eğri/Curved

COTTLE-KNAPP
BC-3900 - BC-3901
Plastik cerrahi makaslar
Scissors for plastic surgery
10.5 cm

BABY-METZENBAUM
BC-3902 - BC-3904
Diseksiyon makasları
Dissecting scissors
14.5 cm

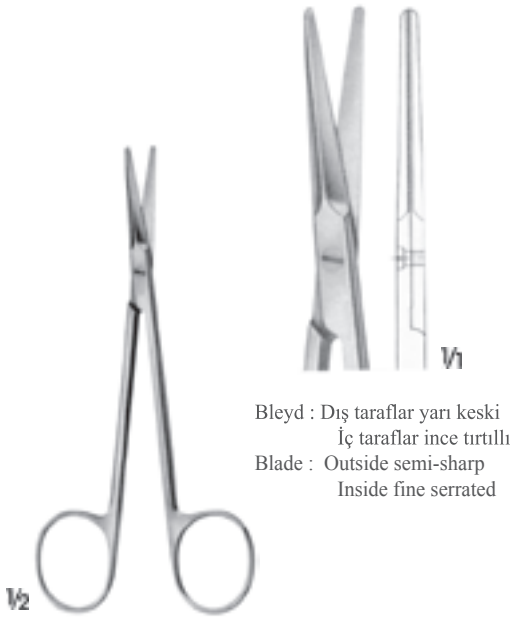

Bleyd : Dış taraflar yarı keski
İç taraflar ince tırtıllı
Blade : Outside semi-sharp
Inside fine serrated

GORNEY
BC-4160
Diseksiyon makası plastik cerrahi için
Dissection scissors for plastic surgery
12.5 cm

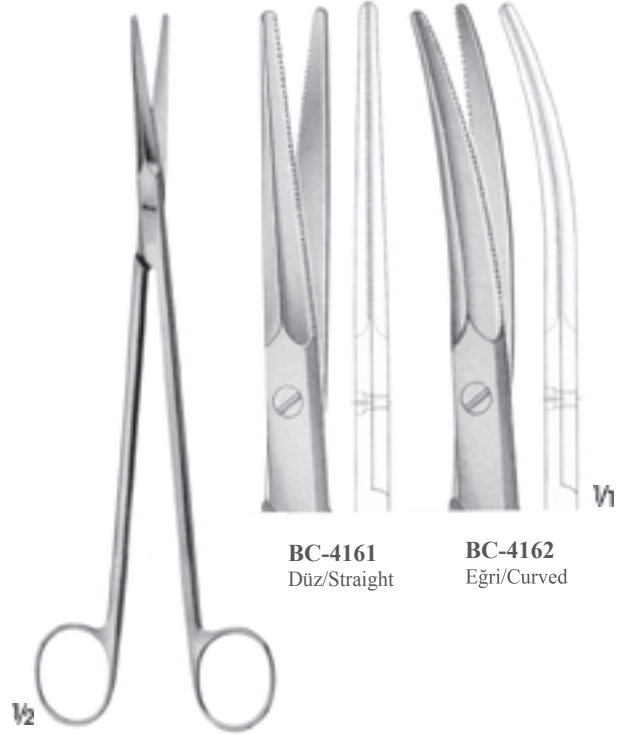

BC-4161
Düz/Straight

BC-4162
Eğri/Curved

GORNEY
BC-4161 - BC-4162
Diseksiyon makasları plastik cerrahi için
Dissection scissors for plastic surgery
19.5 cm

Bleydler : Dış taraflar yarı keski
İç taraflar ince tırtıllı
Blades : Outside semi-sharp
Inside fine serrated

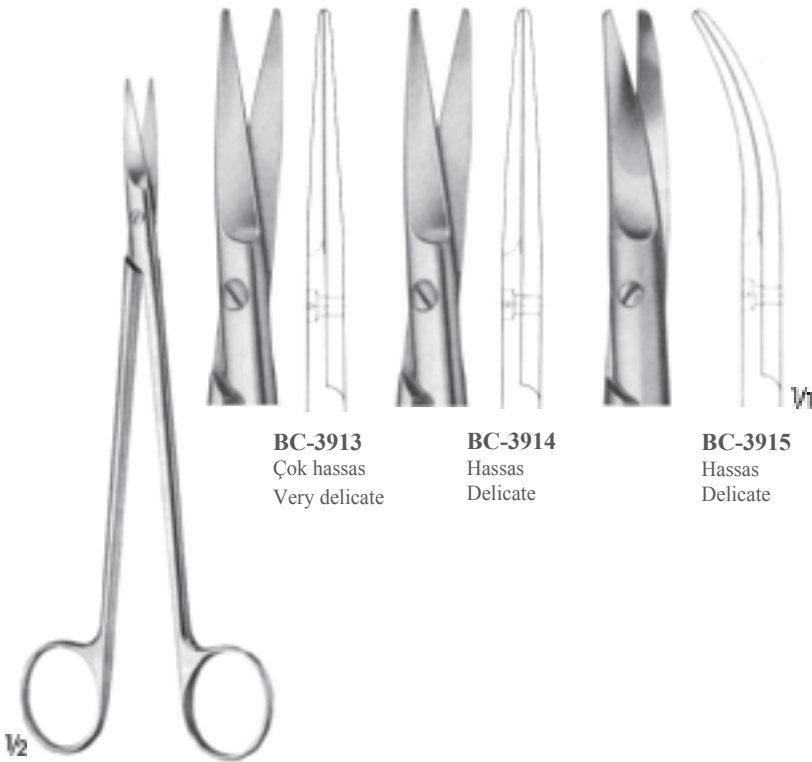

BC-3913
Çok hassas
Very delicate

BC-3914
Hassas
Delicate

BC-3915
Hassas
Delicate

TÖNNIS
BC-3913 - BC-3915
Diseksiyon makasları
Dissecting scissors
18 cm

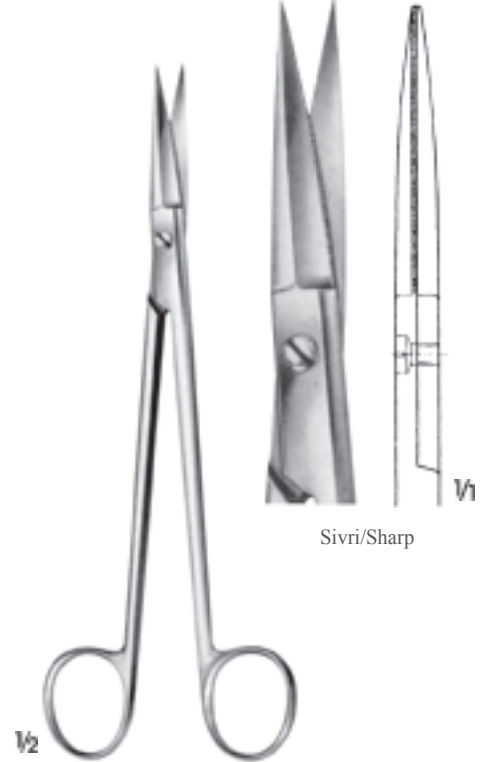

Sivri/Sharp

BC-4165
Kıkırdak makası, çift ağız tırtıllı
Cartilage scissors, blades
cutting on both sides
18.5 cm



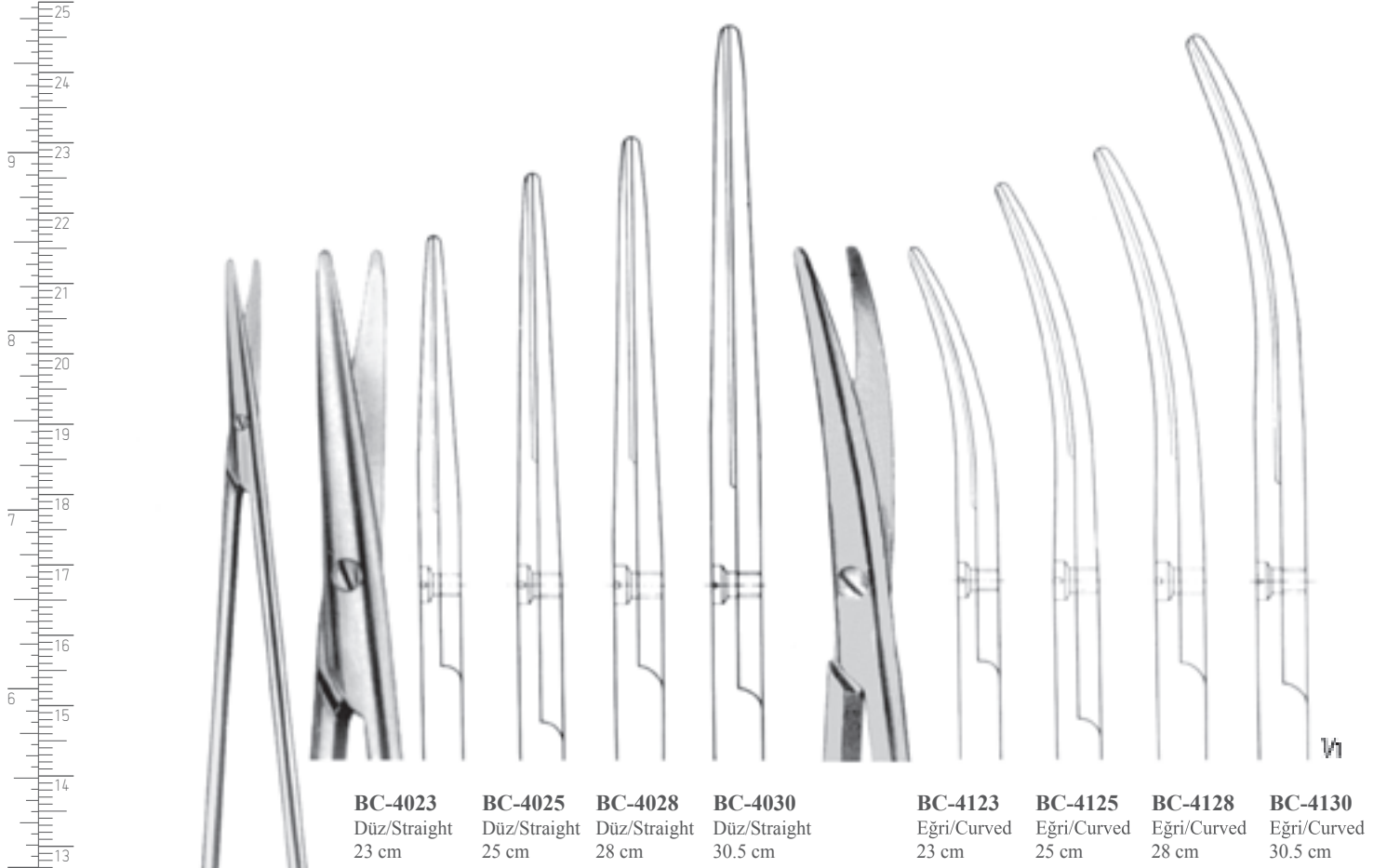

NELSON-METZENBAUM
BC-4023 - BC-4130

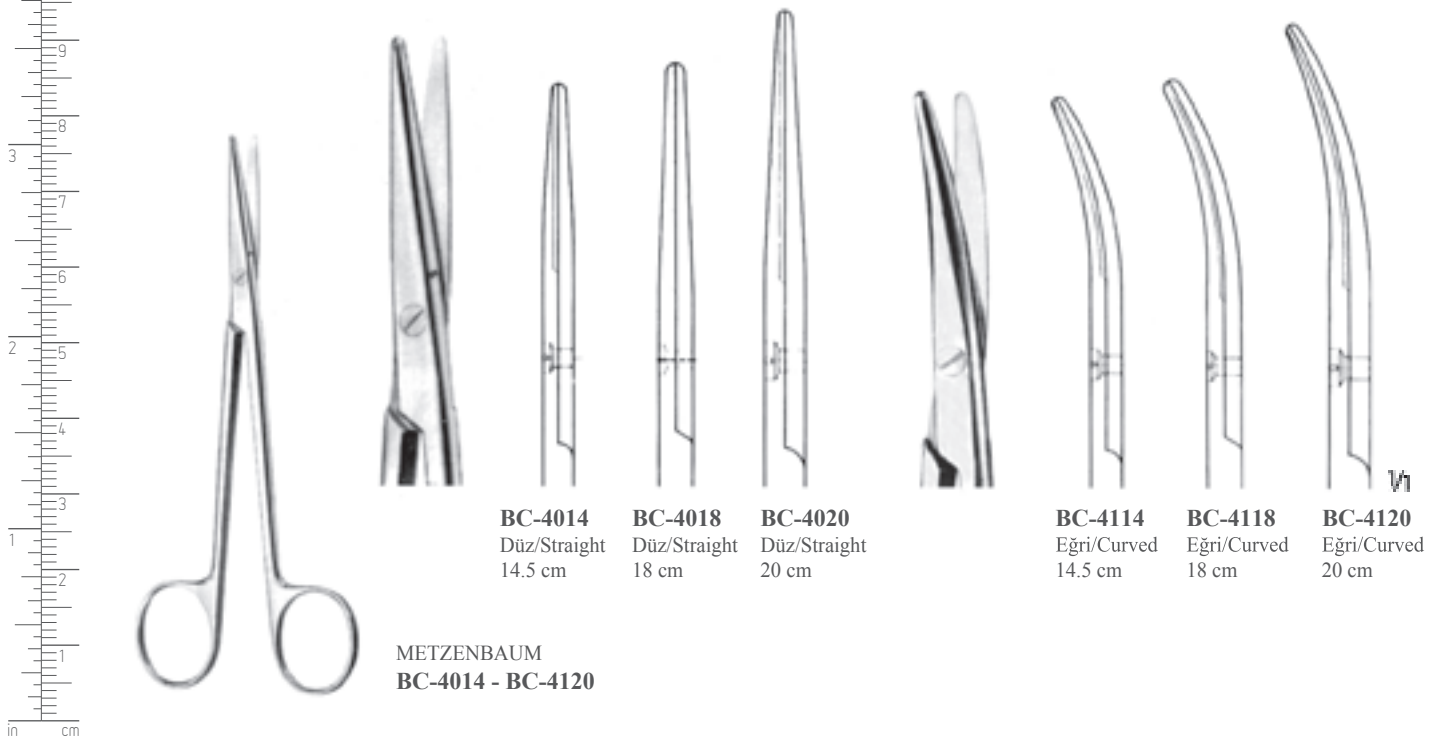

METZENBAUM
BC-4014 - BC-4120

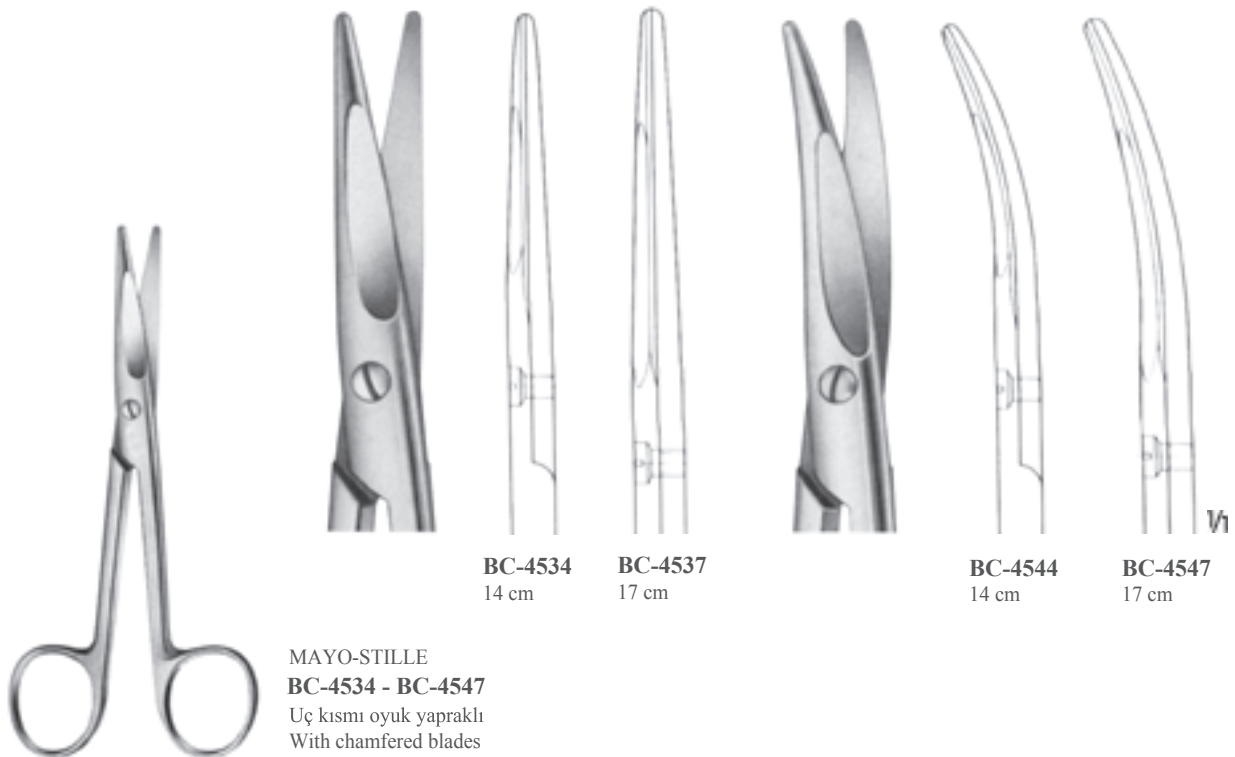
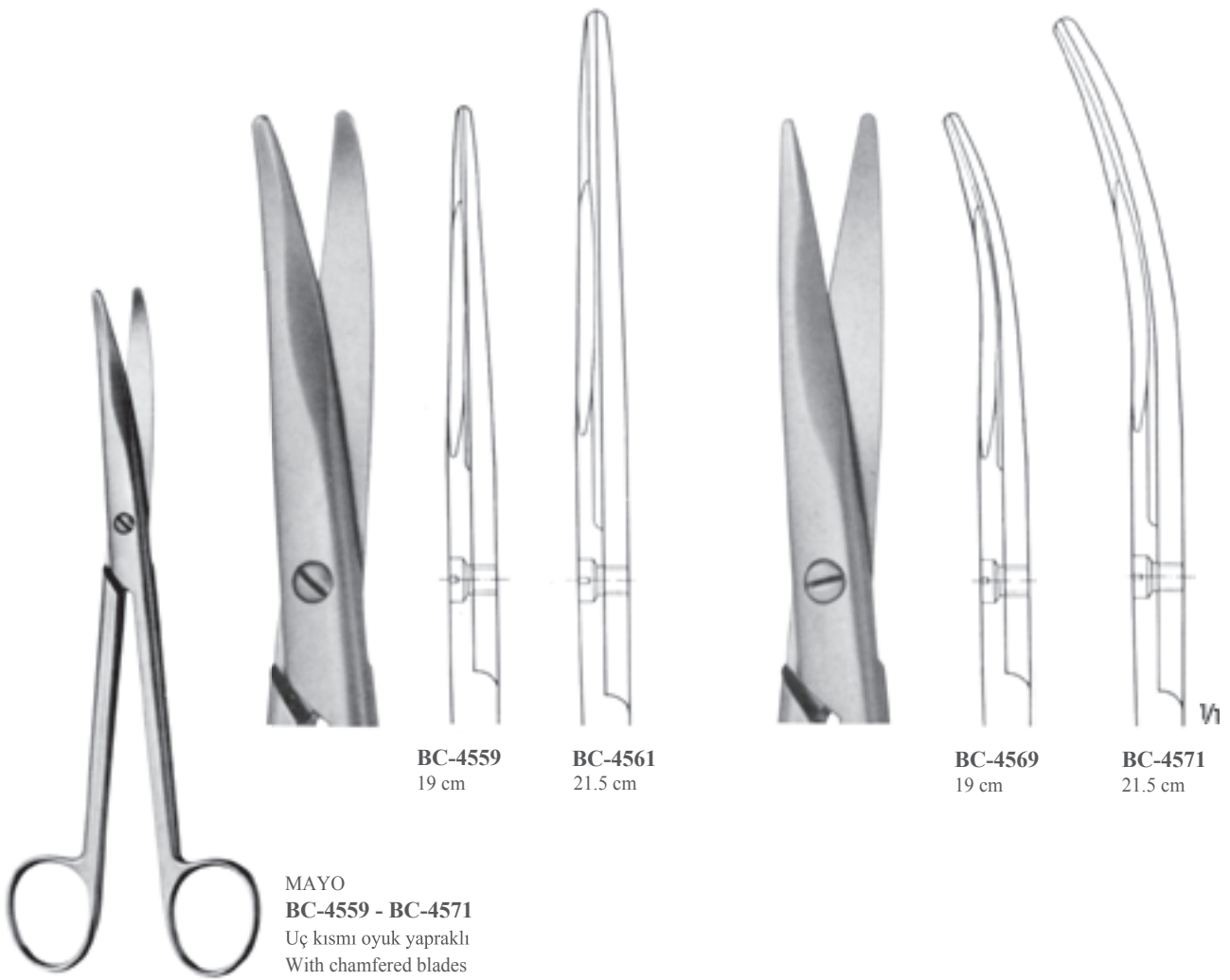

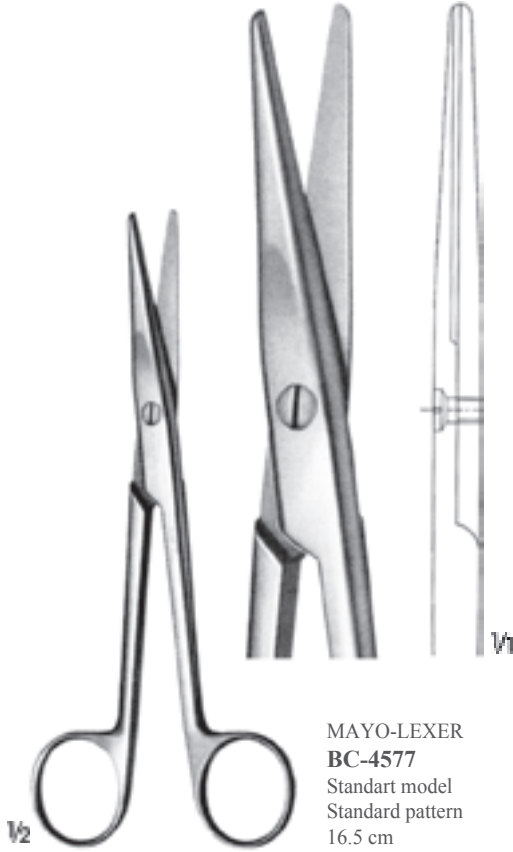

MAYO-LEXER
BC-4577
Standart model
Standard pattern
16.5 cm

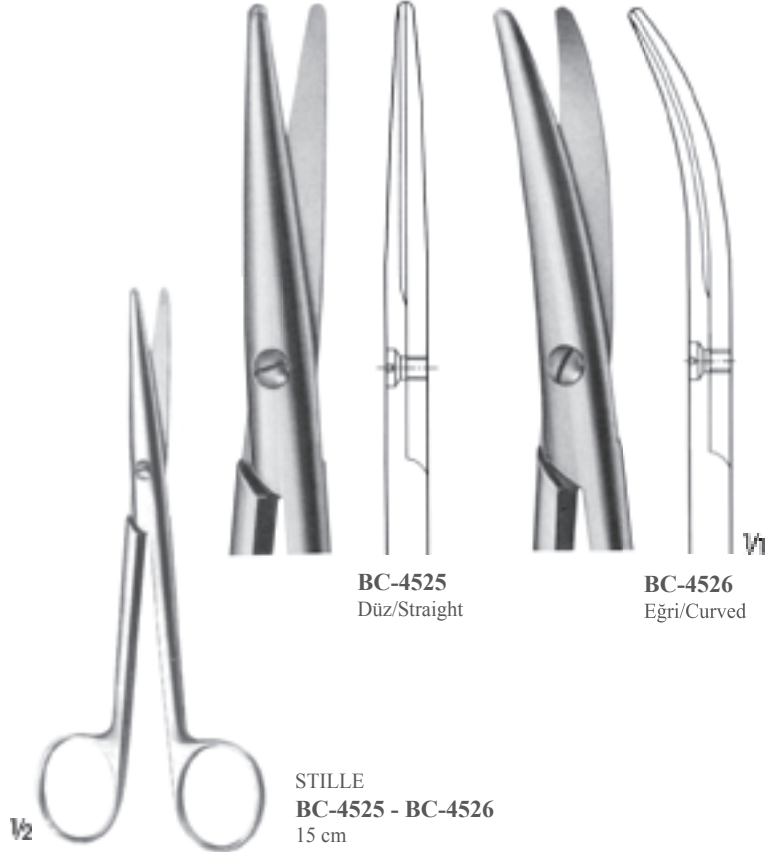

BC-4525
Düz/Straight

BC-4526
Eğri/Curved

STILLE
BC-4525 - BC-4526
15 cm

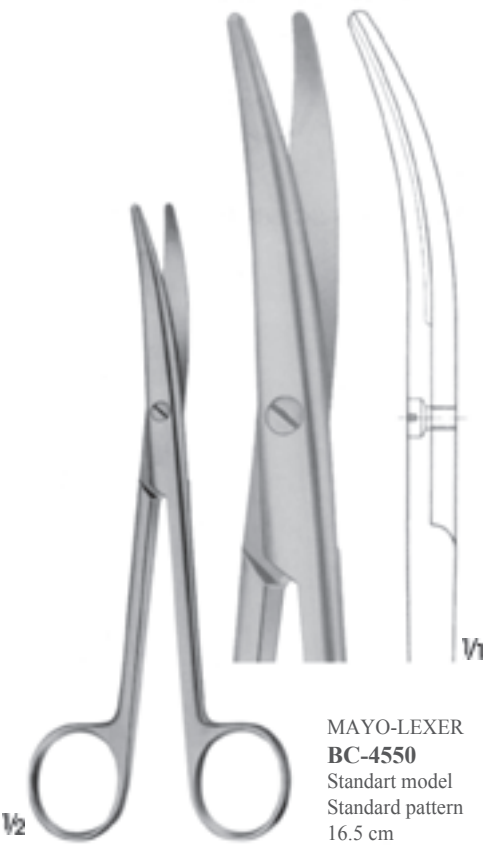

MAYO-LEXER
BC-4550
Standart model
Standard pattern
16.5 cm

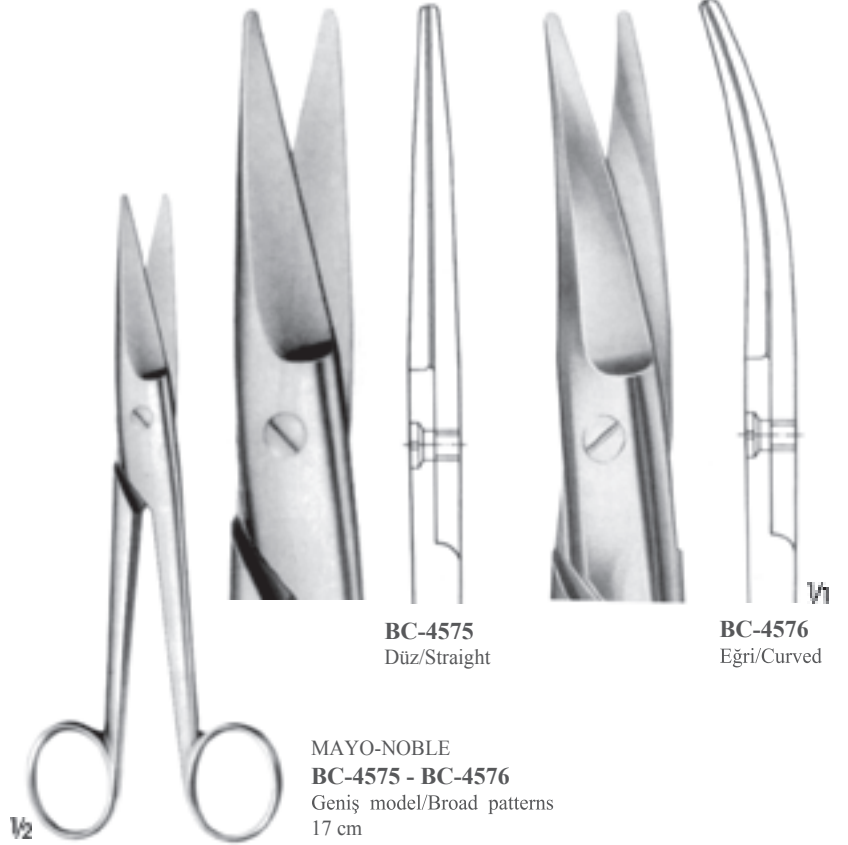

BC-4575
Düz/Straight

BC-4576
Eğri/Curved

MAYO-NOBLE
BC-4575 - BC-4576
Geniş model/Broad patterns
17 cm

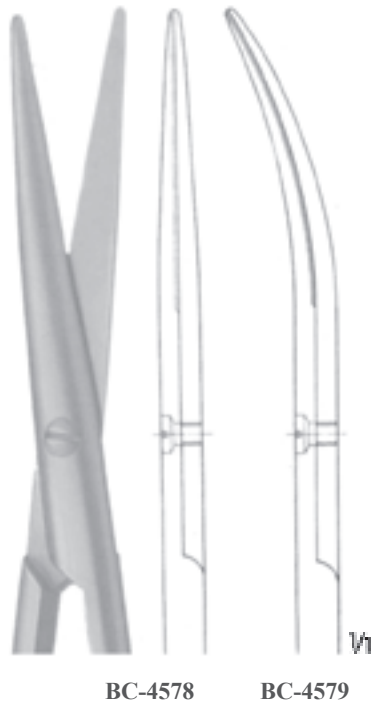

LEXER
BC-4578 - BC-4579
Dar makaslar
Narrow scissors
16.5 cm

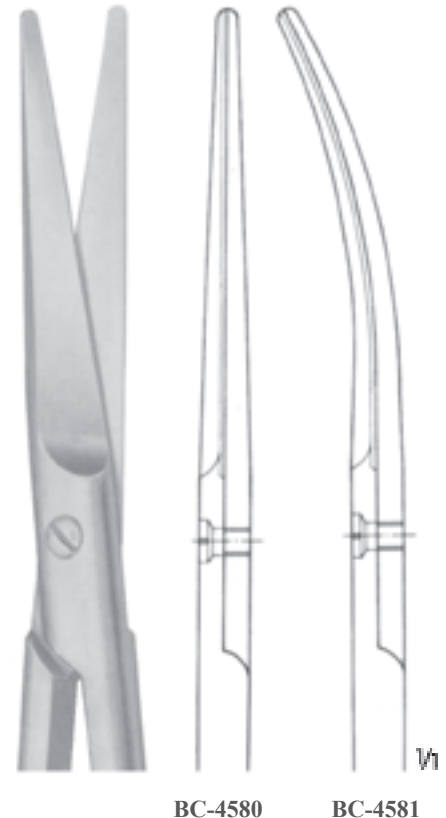

MAYO-HARRINGTON
BC-4580 - BC-4581
23 cm



MAYO
BC-4586 - BC-4590

BC-4586
16.5 cm

BC-4587
20 cm



BC-4588
16.5 cm



BC-4589
20 cm



BC-4590
21 cm





MAYO-STILLE
BC-4414 - BC-4517



BC-4414
Düz/Straight
14 cm



BC-4417
Düz/Straight
17 cm



BC-4514
Eğri/Curved
14 cm



BC-4517
Eğri/Curved
17 cm



W1



MAYO
BC-4214 - BC-4317



BC-4214
Düz/Straight
14 cm



BC-4215
Düz/Straight
15.5 cm



BC-4217
Düz/Straight
17 cm



BC-4314
Eğri/Curved
14 cm



BC-4315
Eğri/Curved
15.5 cm



BC-4317
Eğri/Curved
17 cm



W1

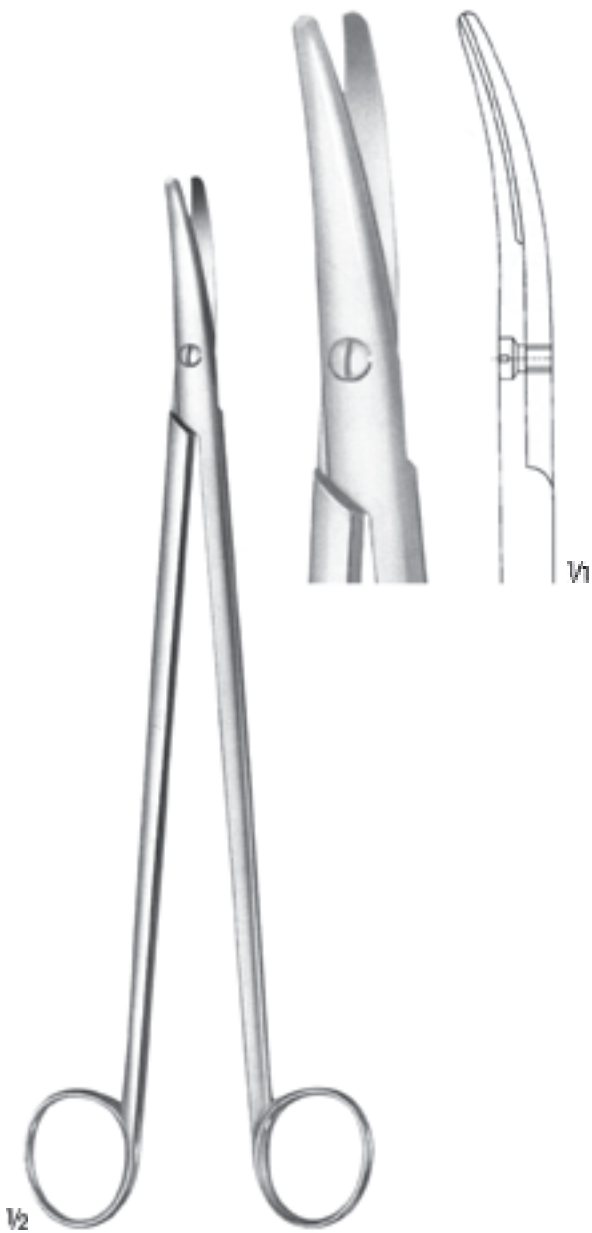

WELLER
BC-4150
Diseksiyon makası, zorlu bölgelerde
Dissecting scissors, heavy pattern
28 cm

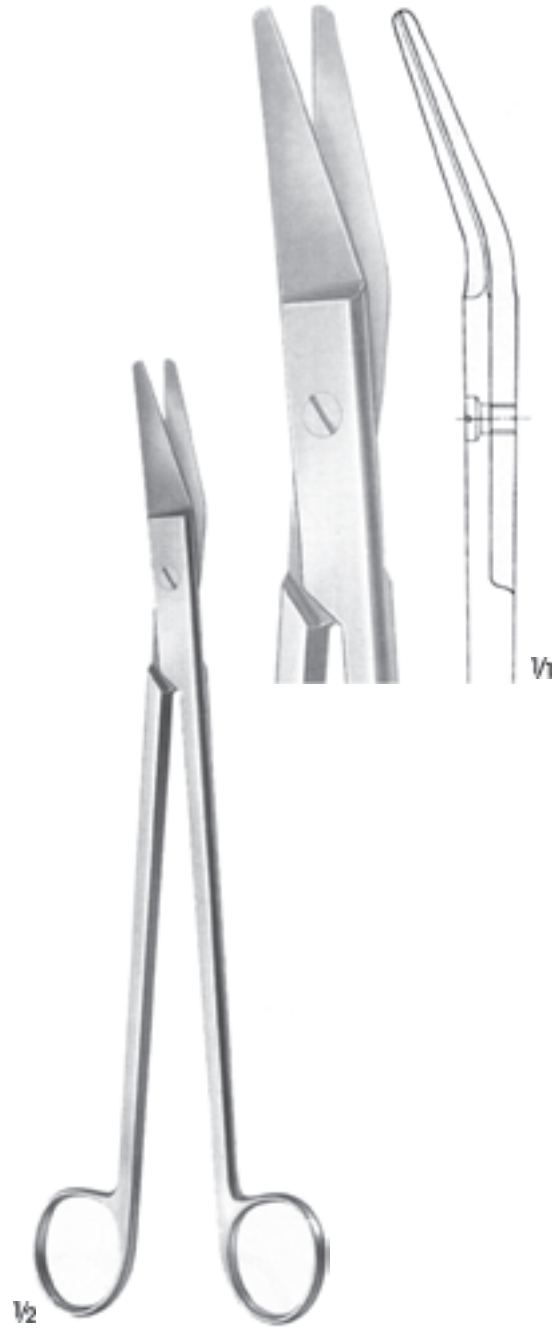

RESANO
BC-5502
Kıkırdak makası/Cartilage scissors
25 cm





STELZNER
BC-5404 - BC-5405
Rektal makas/Rectal scissors
31 cm

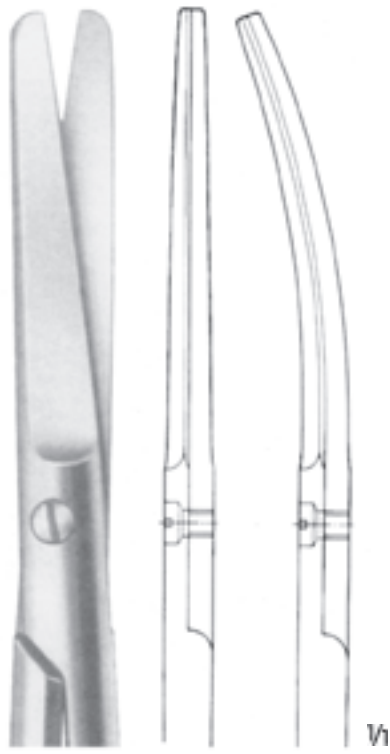

BC-5404 **BC-5405**
Düz/Straight Eğri/Curved

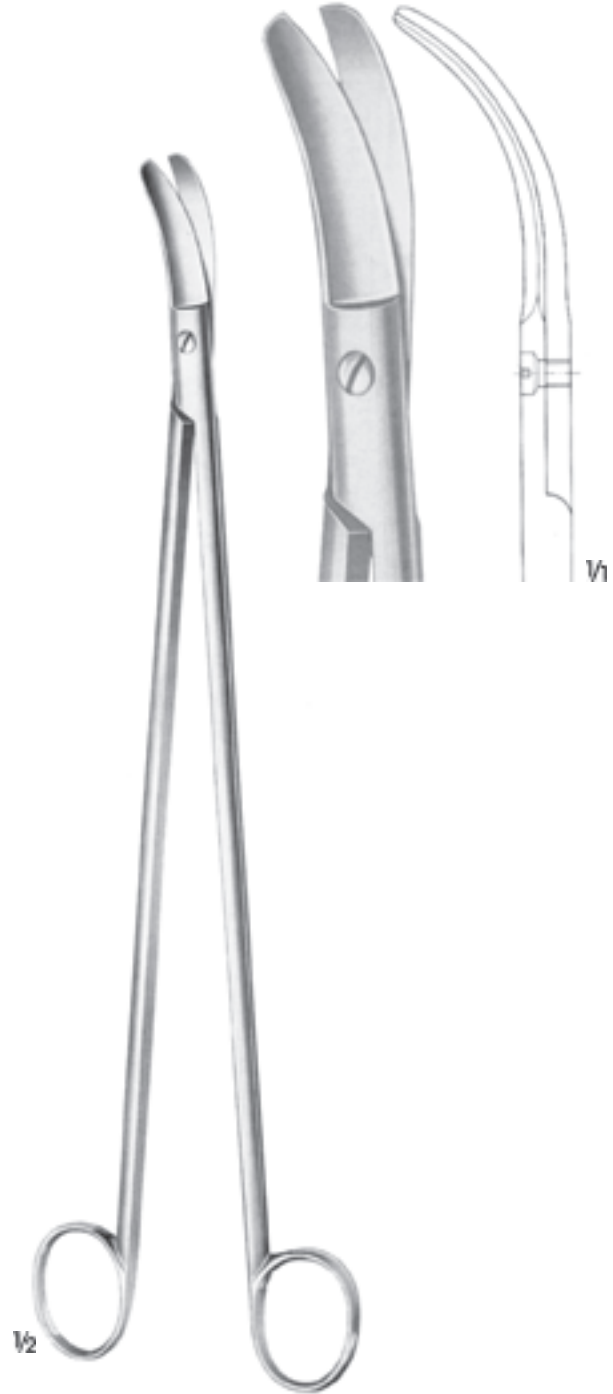

LLOYD-DEVIES(GOLIGHER'S)
BC-5400
Rektal makas/Rectal scissors
25.5 cm

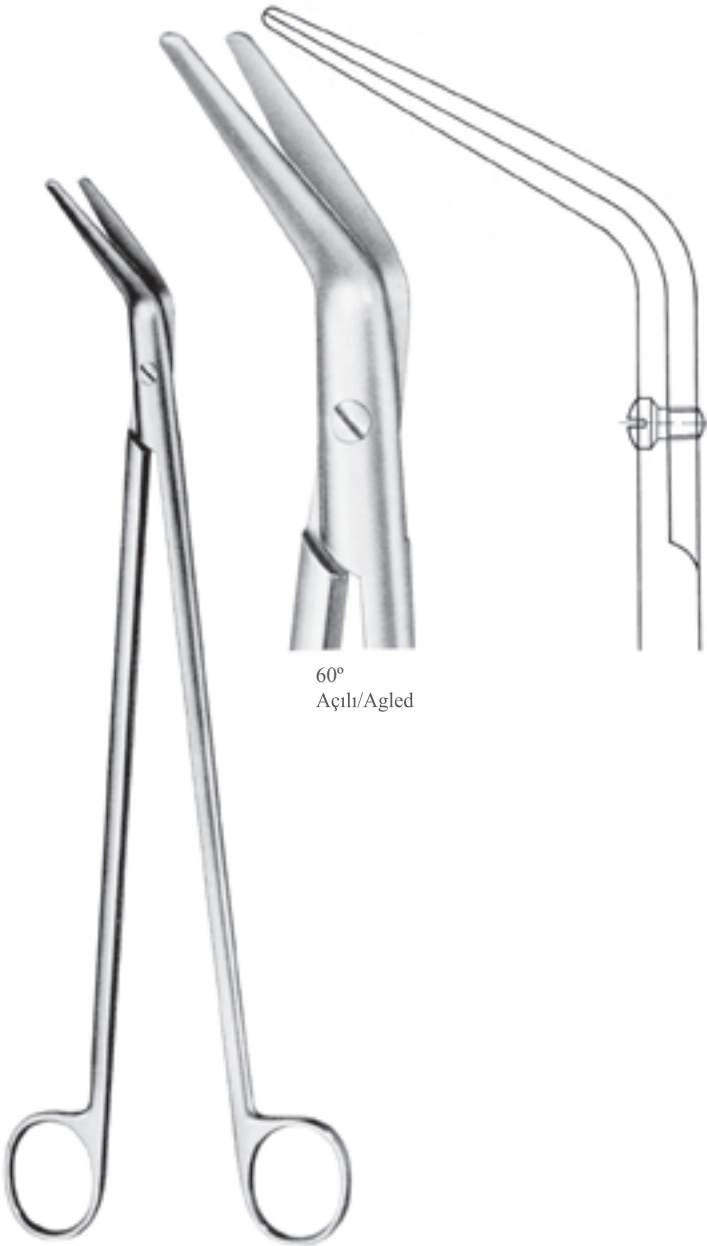

60°
Açılı/Agled

BC-5403

Dikiş atıldıktan sonra bağırsak kesmek için disseksiyon makası
Dissecting scissors for cutting of the bowel after suturing with suture device
28 cm

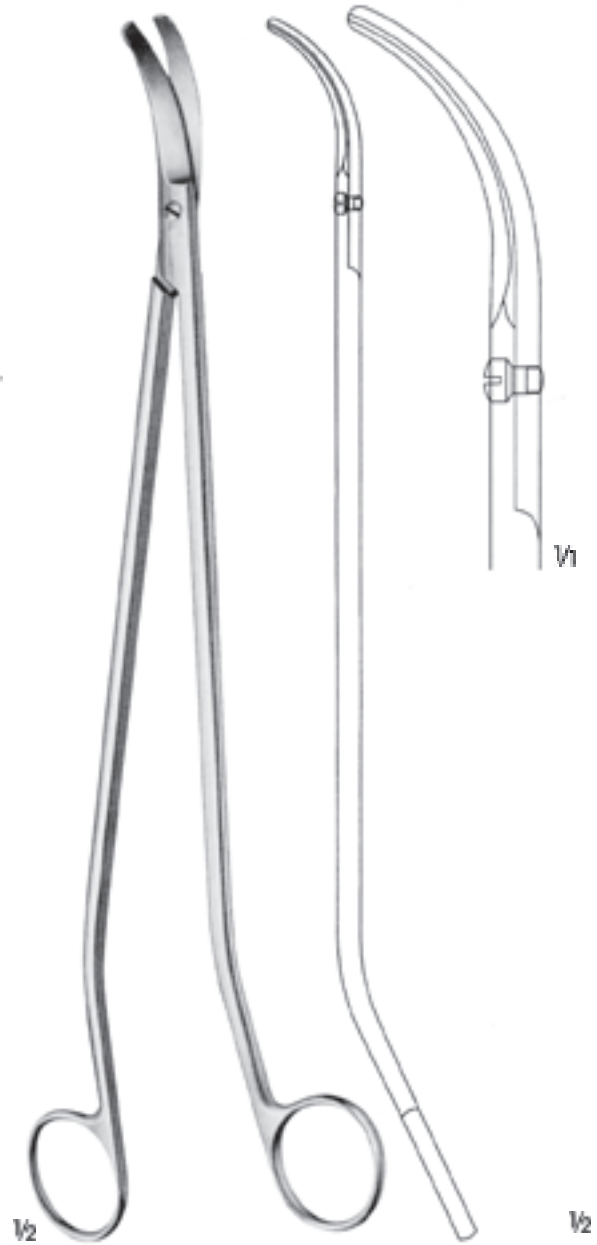

**MÜLLER
BC-5406**

Rektal makas/Rectal scissors
S-şeklinde/S-shaped
32.5 cm





KEIBACK
BC-5419 - BC-5420

Parametrium makasları, yana kavisli,
tek ağızı sonda uçlu
Parametrium scissors, curved to side,
with one probe pointed blade



BC-5419 26 cm
BC-5420 35 cm



KEIBACK
BC-5417 - BC-5418
Parametrium makası
Parametrium scissors

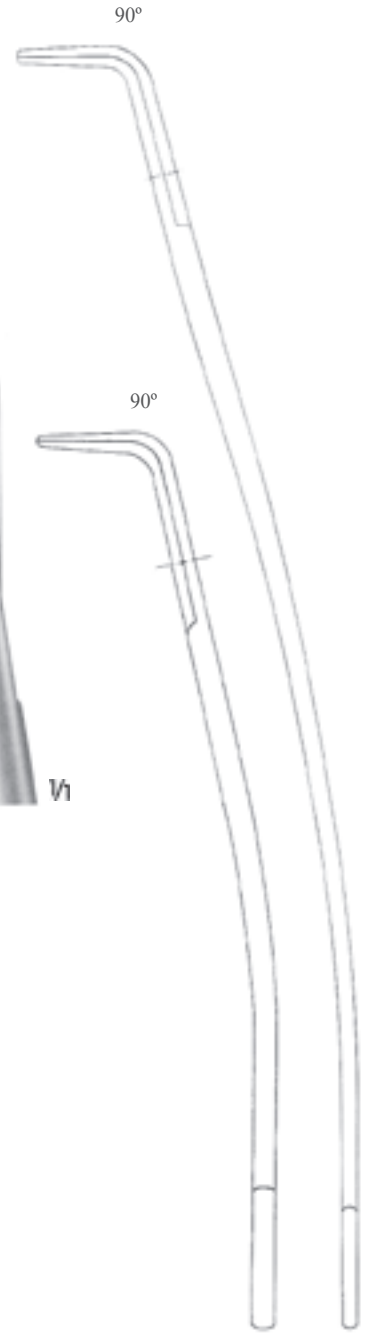

BC-5417 24 cm
BC-5418 35 cm



SIEBOLD
BC-4633
Rahim makası/Uterine scissors
24.5 cm



BOZEMANN
BC-4632
Rahim makası/Uterine scissors
22 cm



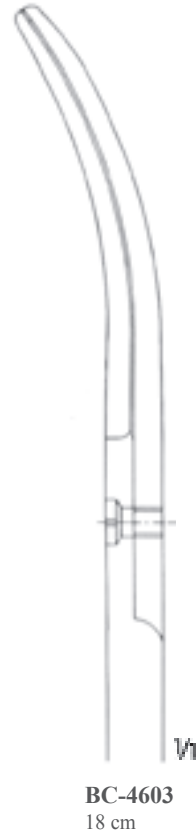
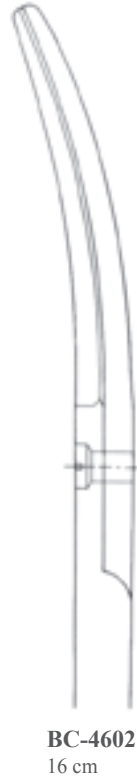

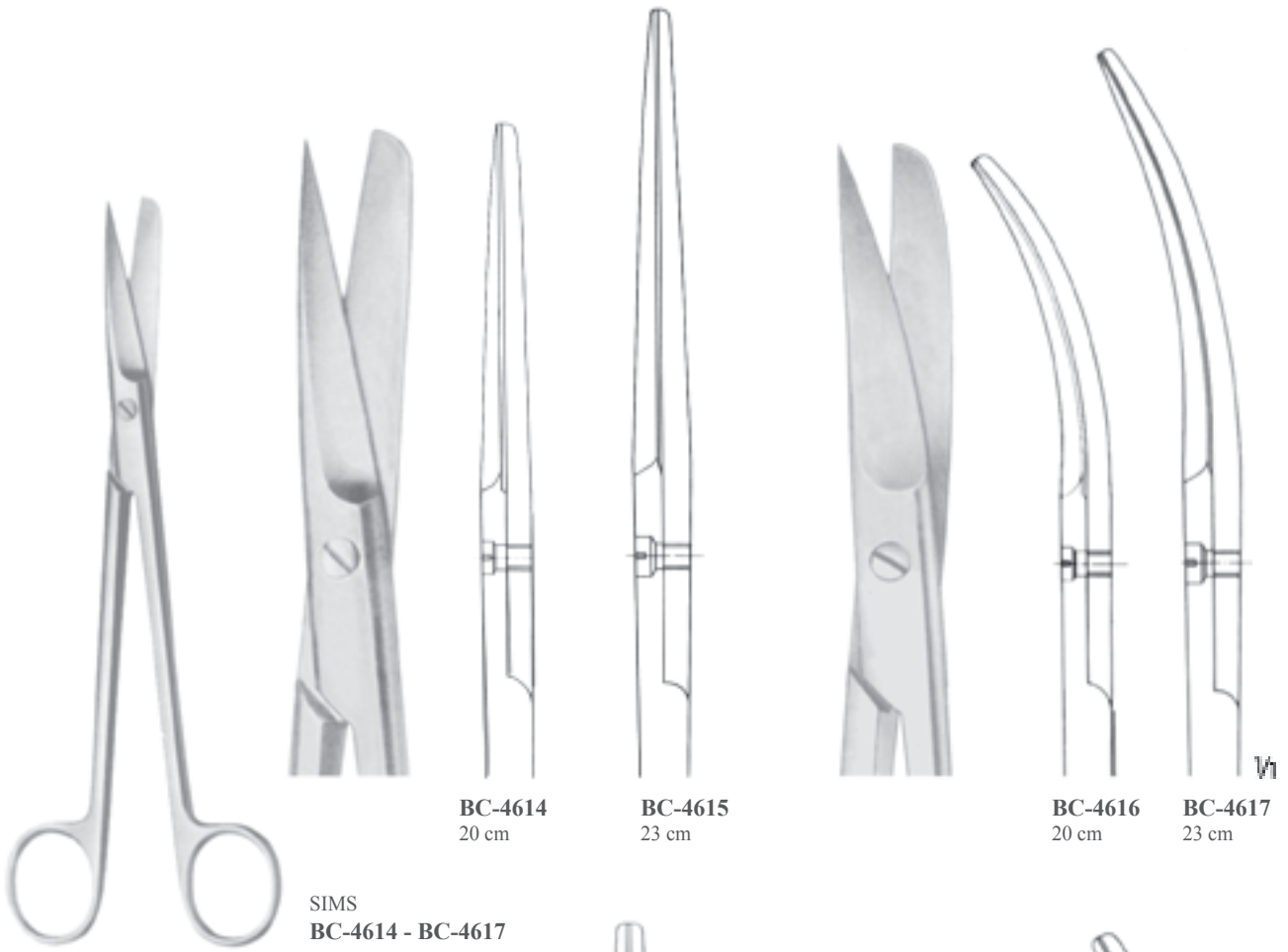

SIMS
BC-4614 - BC-4617

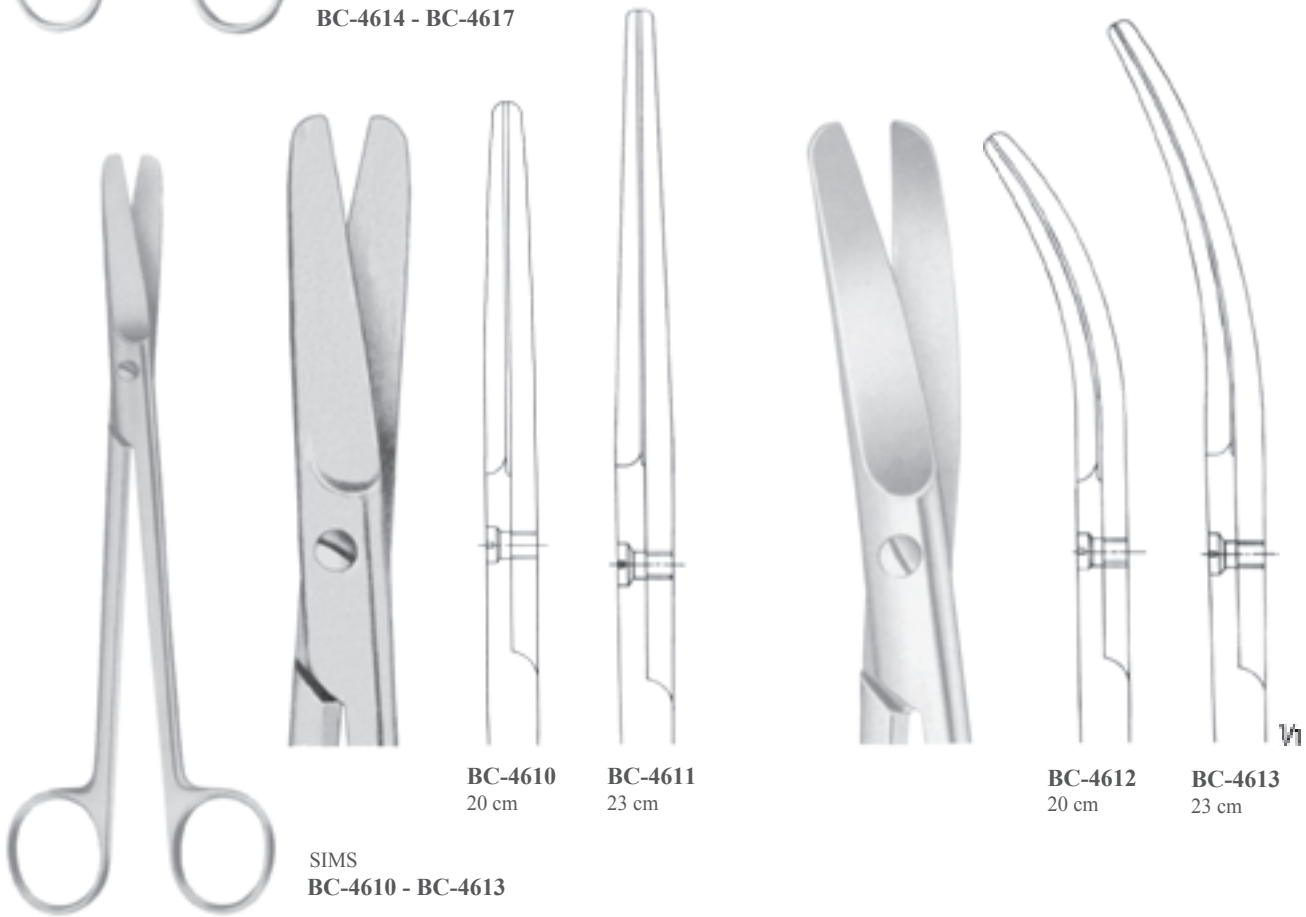

SIMS
BC-4610 - BC-4613





DUBOIS
BC-5415 - BC-5416
Embriyo makası/Embryo scissors
27.5 cm



BC-5415
Düz/Straight



BC-5416
Eğri/Curved



SIMS SIEBOLD
BC-4634
Rahim makası/Uterine scissors
25 cm



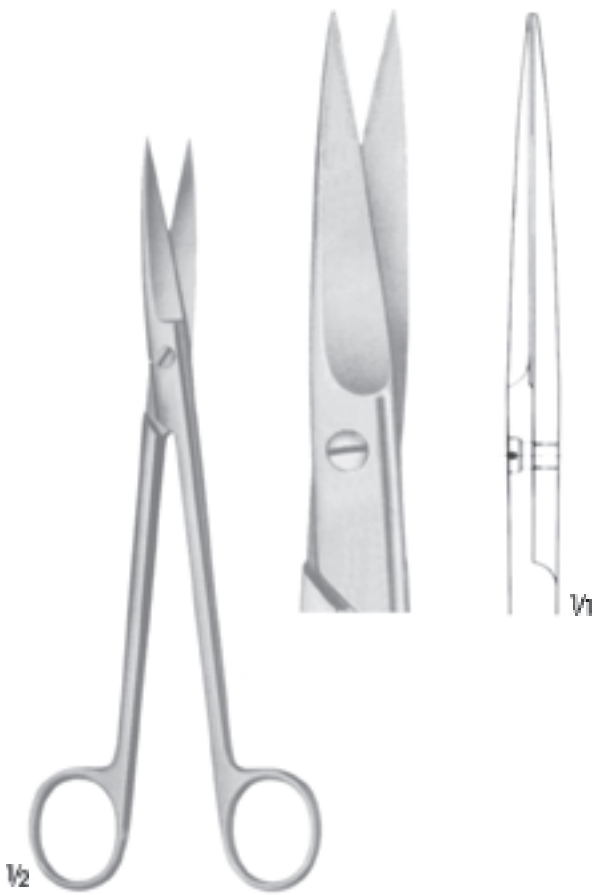

SIMS
BC-4630
20 cm

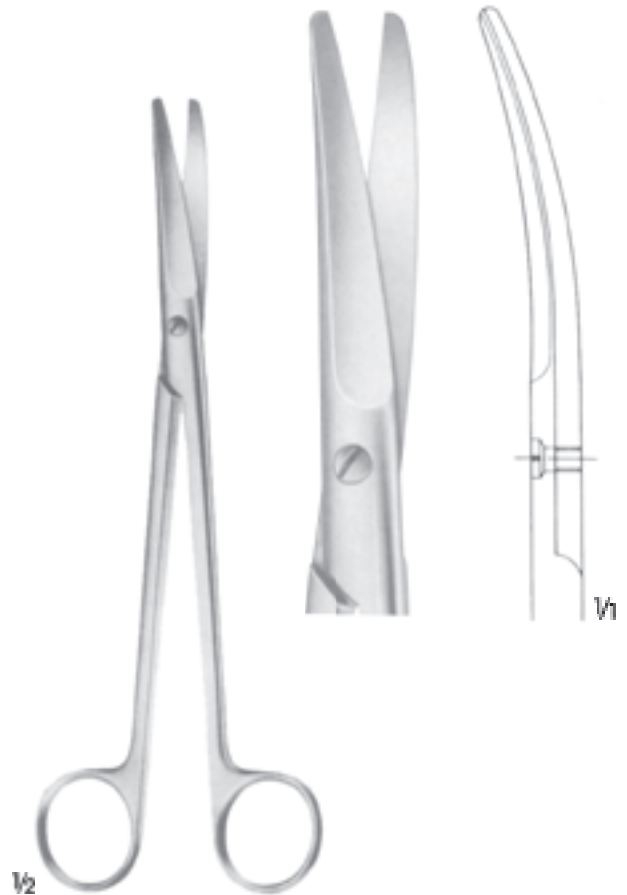

SIMS
BC-4631
21 cm



WERTHEIM
BC-4620 - BC-4622

BC-4620
14.5 cm

BC-4621
20 cm

BC-4622
23 cm





Standart bleyd
Standard blade



BC-5025



BC-5045



BC-5060



BC-5090



BC-5095

Hassas bleyd
Delicate blade



BC-4925



BC-4945



BC-4960



BC-4990



BC-4995

Ultra hassas bleyd
Ultra delicate blade



BC-4825



BC-4845



BC-4860



BC-4890



BC-4895

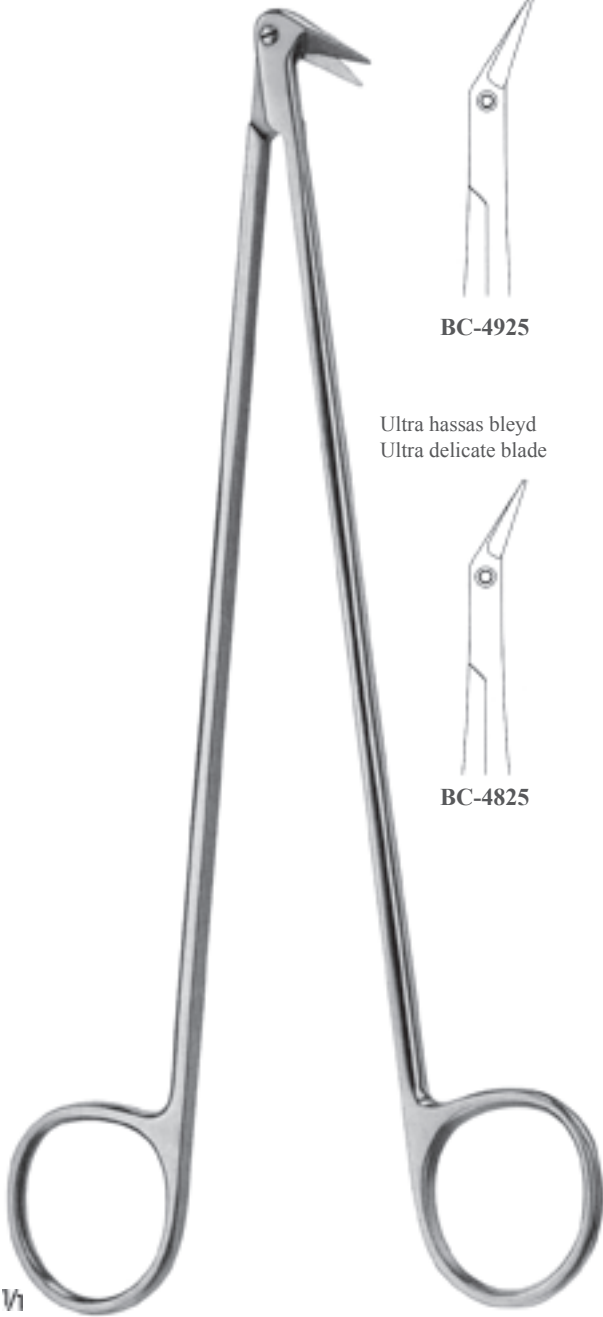

BC-4825 - BC-5095
18 cm

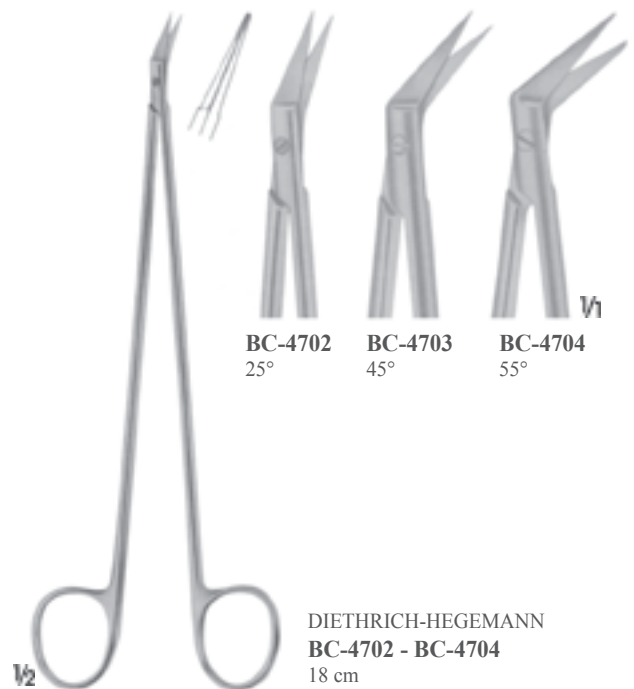
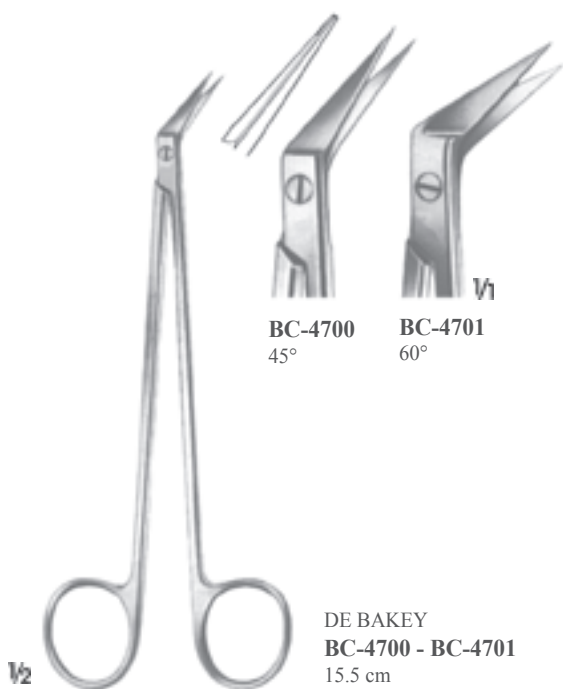
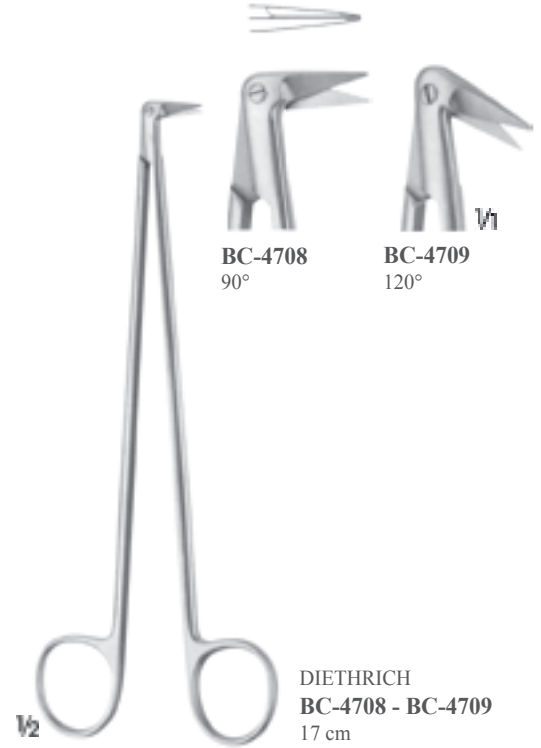
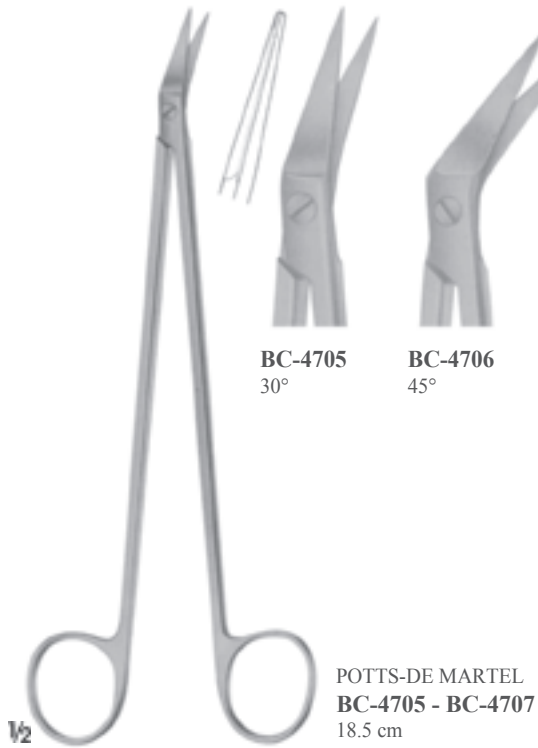



BC-5155
düz açılı ağız
Angled on flat
55°

POTTS-SMITH
BC-5155
Kardiyovasküler makas
Cardiovascular scissors
18 cm



BC-5145
45°

DE BAKEY
BC-5145
S Şekilli makas
S-Shaped scissors
15.5 cm

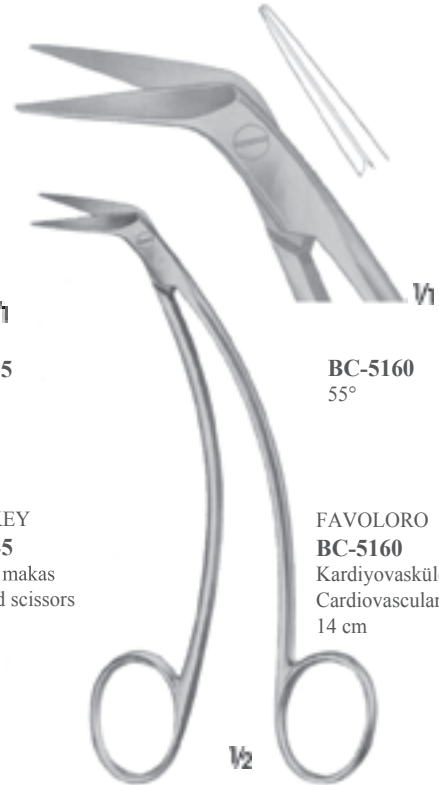

BC-5160
55°

FAVOLORO
BC-5160
Kardiyovasküler makas
Cardiovascular scissors
14 cm

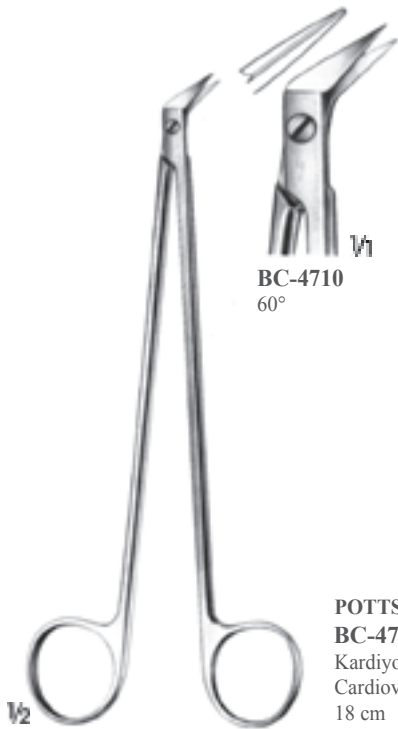

BC-4710
60°

POTTS-SMITH
BC-4710
Kardiyovasküler makas
Cardiovascular scissors
18 cm



POTTS-
DE MARTEL
BC-4711 60°

MILLS
BC-4712 60°

BC-4711 - BC-4712
Kardiyovasküler makaslar
Cardiovascular scissors
22 cm

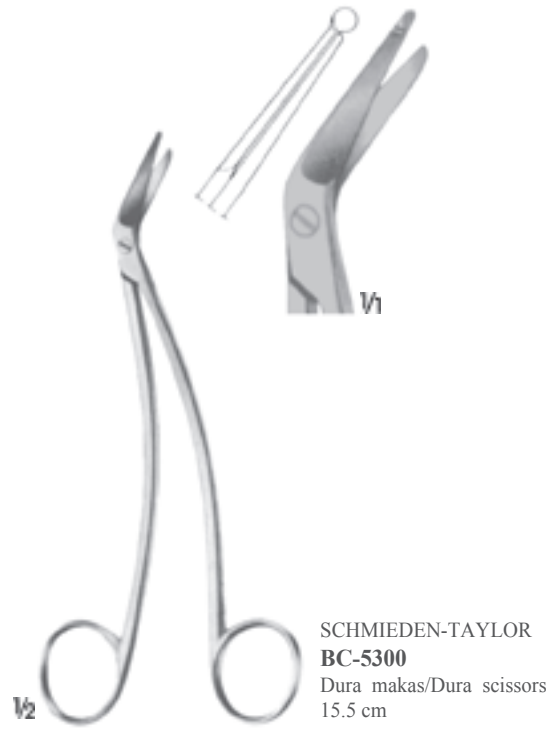
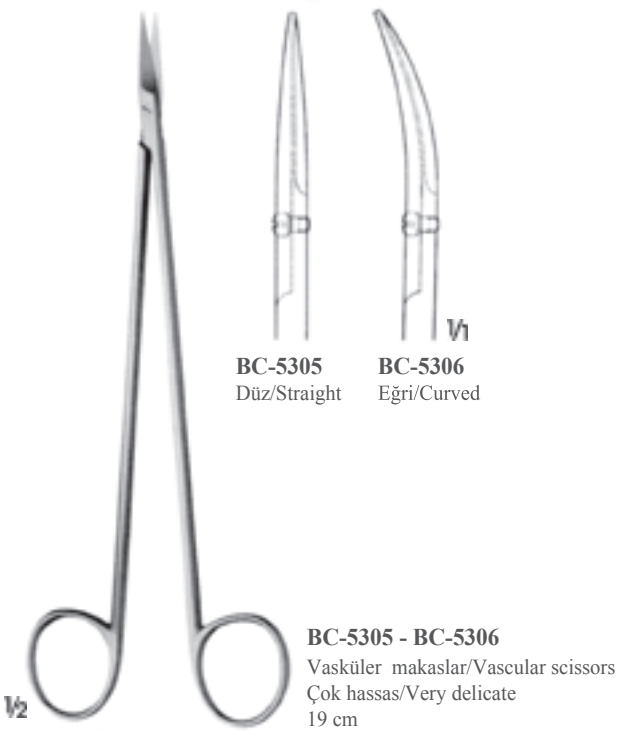
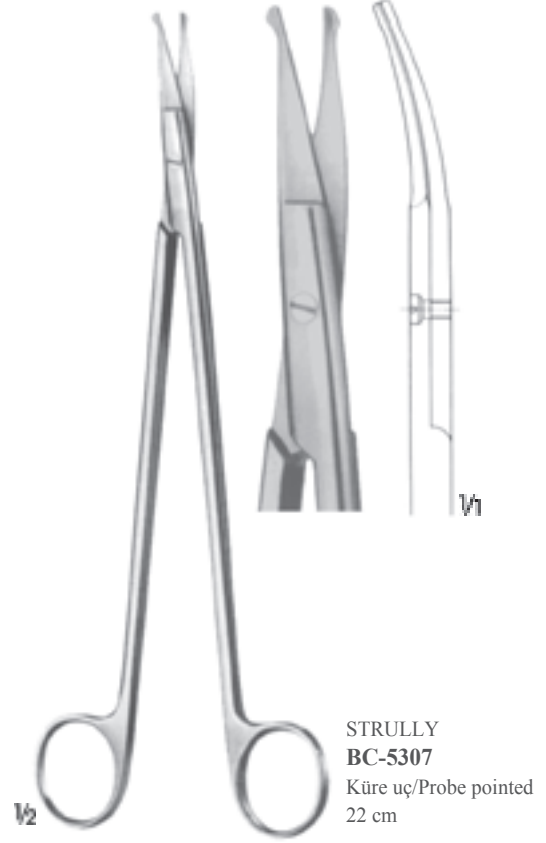
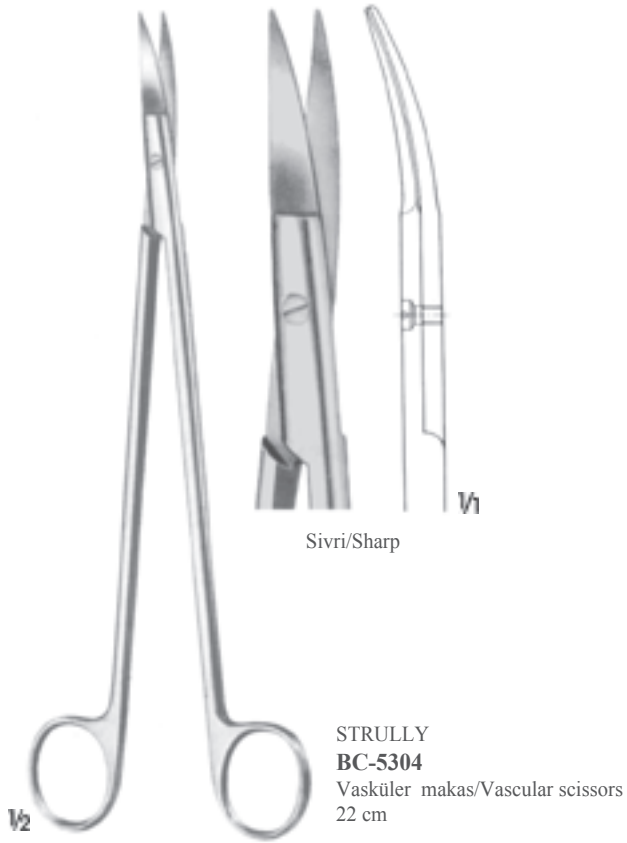

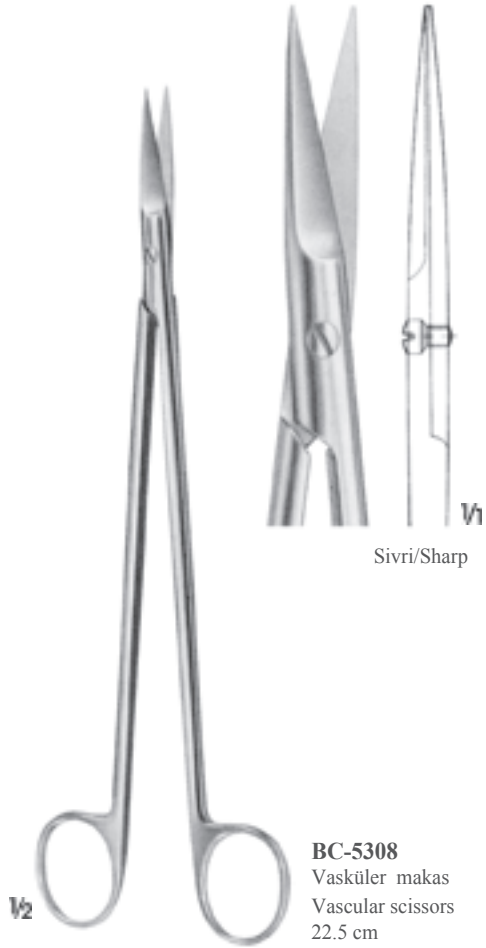
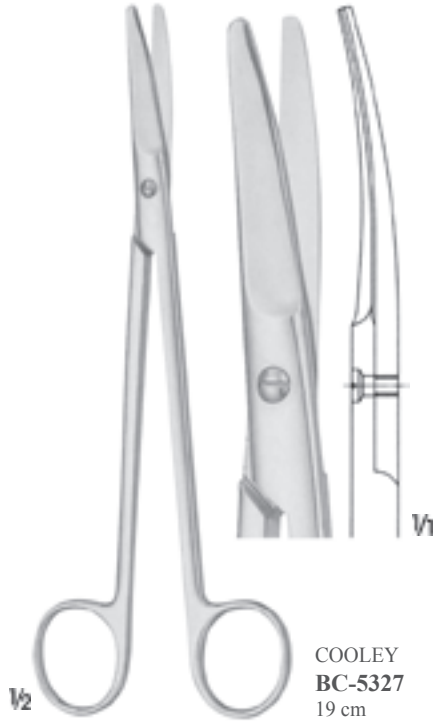

Sivri/Sharp

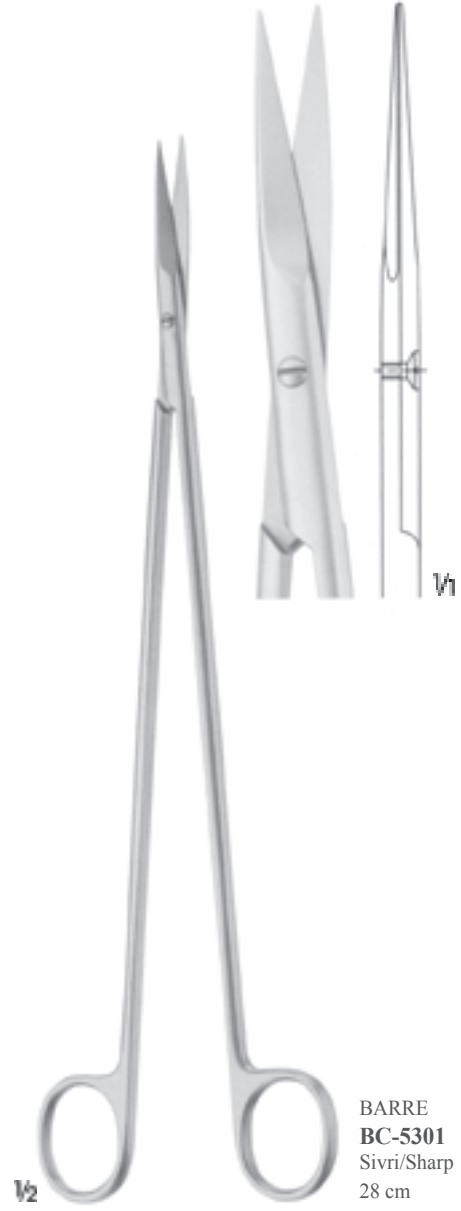

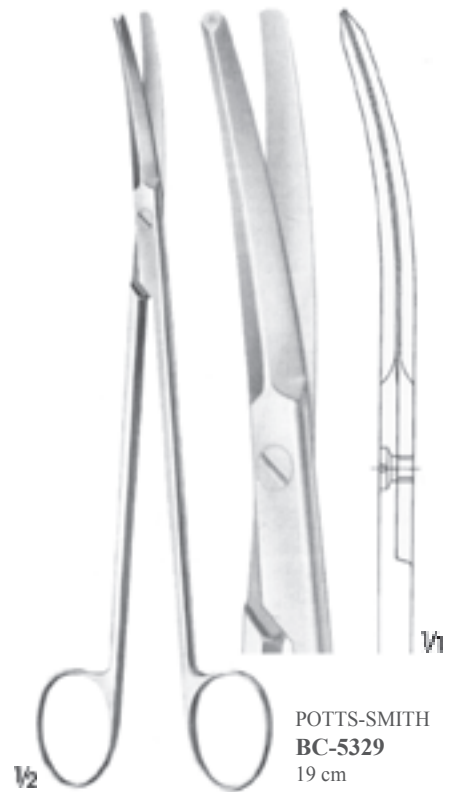
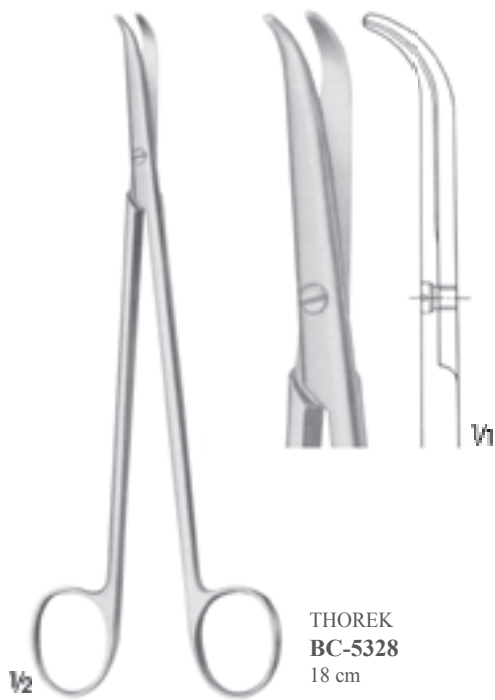
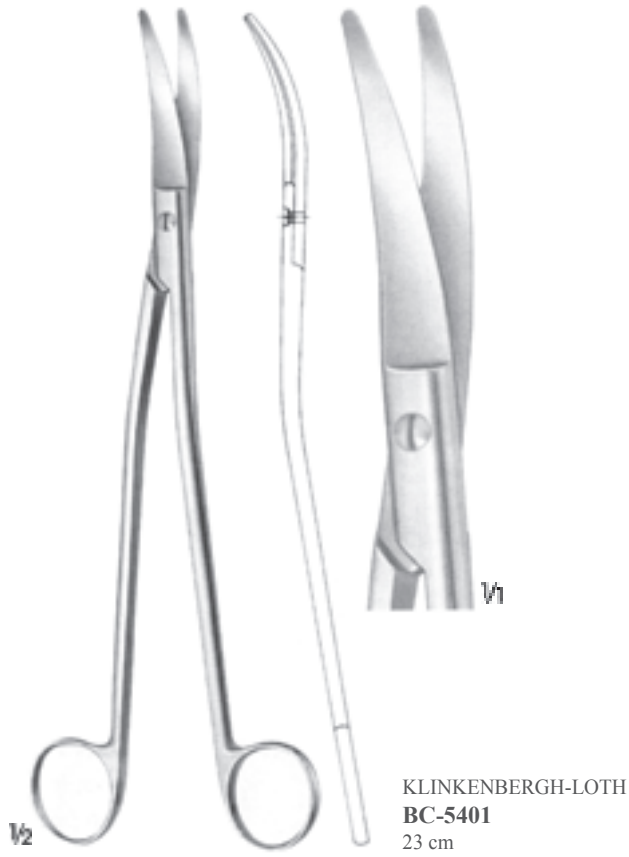



BC-5410
13.5 cm



BC-5411
16 cm

BC-5410 - BC-5411
Göbek kordonu makasları
Umbilical Cord scissors

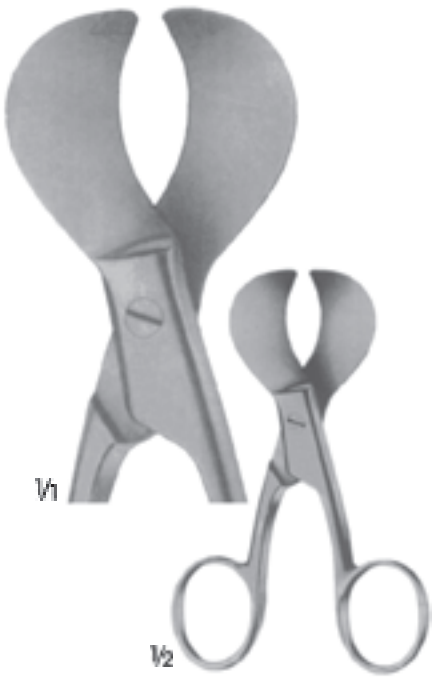

V1

V2

BC-5408
Göbek kordonu makası
Umbilical cord scissors
10.5 cm



V1

V2

SCHUMACHER
BC-5409
Göbek kordonu makası
Umbilical cord scissors
15.5 cm



BC-5414
Epizyotomi makası/Episiotomy scissors
24 cm

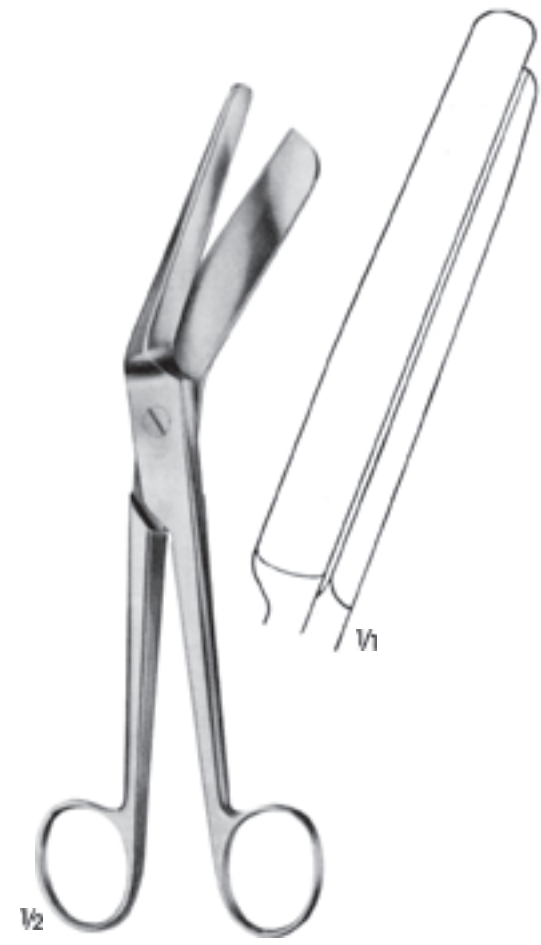

BRAUN-STADLER
BC-5211
Bandaj makası/Bandage scissors
22.5 cm



BRAUN-STADLER
BC-5412 - BC-5413
Epizyotomi makasları/Episiotomy scissors



BC-5412
14.5 cm



BC-5413
20 cm



LISTER
BC-5204 - BC-5207

BC-5204
11.5 cm



BC-5205
14 cm



BC-5206
18 cm



BC-5207
20 cm

V1



KNOWLES
BC-5200
14.5 cm



V2



KNOWLES
BC-5201
14 cm



V1



KNOWLES
BC-5202 - BC-5203



BC-5202
15.5 cm



BC-5203
18 cm

V1



BC-5345
20 cm

ESMARCH
BC-5345 - BC-5350
Alçı makasları/Plaster scissors
Tek ağız tırtıllı/One jaw serrated



BC-5350
23 cm



BERGMANN
BC-5355
Alçı makası/Plaster scissors
Tek ağız tırtıllı/One jaw serrated
23 cm



LISTER
BC-5208
Bandaj makas
Bandage scissors
16 cm



BC-5209
Küçük alçı kesme makası
For small plaster dressing
Tek ağız tırtıllı/One jaw serrated
16 cm





BRUNS
BC-5360
Alçı makası
Plaster scissors
23.5 cm

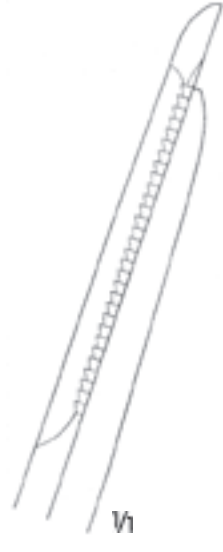

BC-5365
Alçı ve kumaş kesme makası
Plaster and cloth scissors
Tek ağız tırtıllı
One jaw serrated
23.5 cm



SEUTIN
BC-5212
Bandaj makası/Bandage scissors
Tek ağız tırtıllı/One jaw serrated
23 cm



BC-5210
Kumaş makası/Cloth scissors
Tek ağız tırtıllı/One jaw serrated
20.5 cm



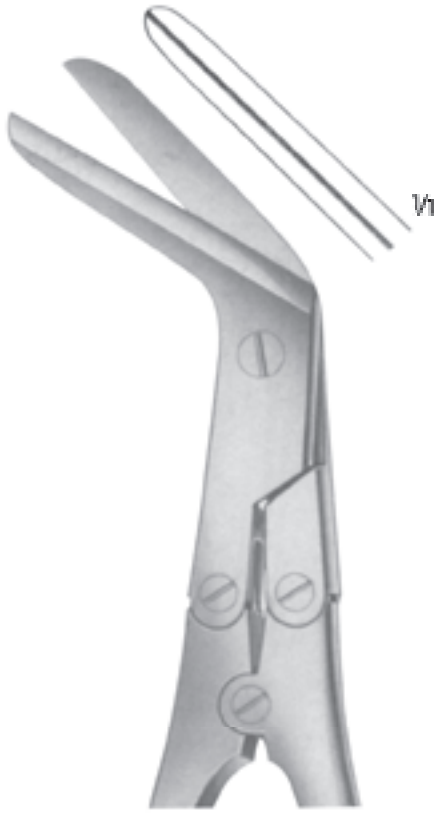

KILLIAN
BC-5393
Çift ağız tırtıllı
Both jaws serrated
20 cm



MUHLING
BC-5394
21 cm



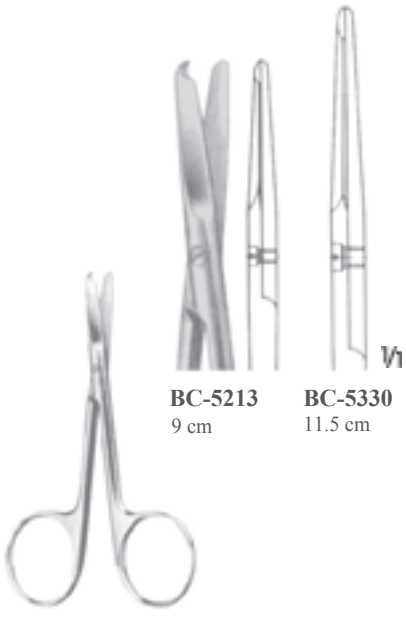

SPENCER
BC-5213 - BC-5330
Ligatür makası
Ligature scissors



LITTAUER
BC-5335
Ligatür makası
Ligature scissors



NORTHBENT
BC-5340
Ligatür makası
Ligature scissors



BC-2904
Tırnak makası
Nail scissors



BC-2903
Hassas bölge için tırnak makası
Nail Scissors, especially delicate
pattern



BC-2905
Çocuk tırnak makası
Baby nail scissors



HARVEY
BC-5385
Çift ağız tırtıllı
Both jaws serrated
12.5 cm

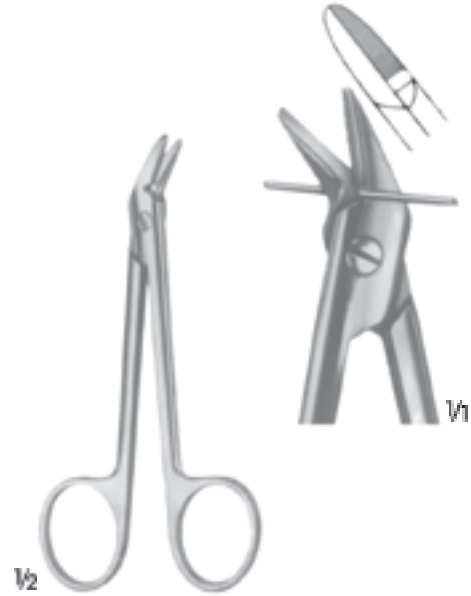

BC-5390
Tek ağız tırtıllı
One jaws serrated
12 cm



BEEBE
BC-5380 - BC-5383
11 cm

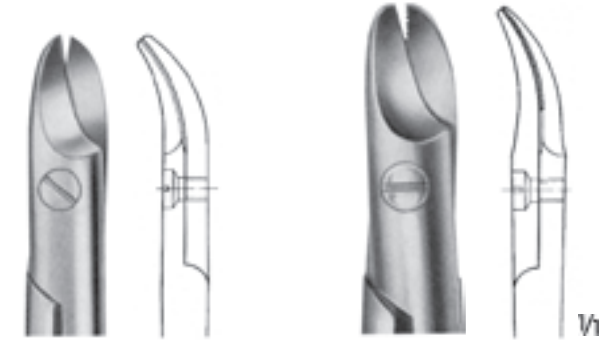

BC-5380 **BC-5381**

BC-5382
Geniş ağız bleyd
Broad blades

BC-5383
Tek ağız tırtıllı
One jaw serrated





Karbür kesme ucu yerleştirilmiş HARDMODEL makaslar

- Mükemmel kesim
- Uzun çalışma ömrü

HARDMODEL scissors with inserted carbide cutting edges

- Excellent Cutting
- Long working

SuperCut

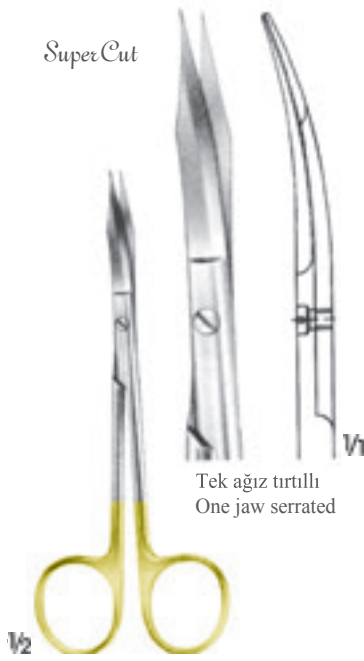

Tek ağız tırtıllı
One jaw serrated

BC-5505
Eğri/Curved
Hassas makas/Delicate scissors
13 cm



BC-5510 - BC-5511
Cerrahi makaslar/Surgical scissors
Sivri/Sharp
Künt/Blunt
14.5 cm

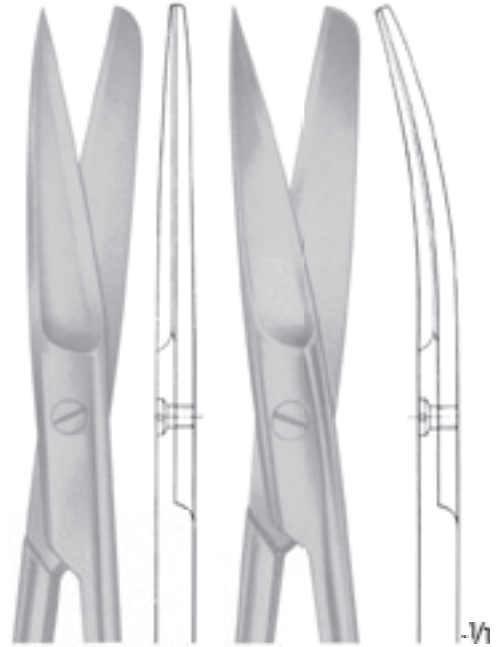

BC-5510
Düz/Straight

BC-5511
Eğri/Curved

SuperCut



BC-5500
Düz/Straight

BC-5501
Eğri/Curved

BC-5500 - BC-5501
Hassas ligatür makasları
Delicate ligature scissors
11 cm

SuperCut



BC-5503
Düz/Straight

BC-5504
Eğri/Curved

BC-5503 - BC-5504
Hassas makaslar
Delicate scissors
12 cm



MAYO
BC-5515 - BC-5617
Diseksiyon makasları/Dissecting scissors

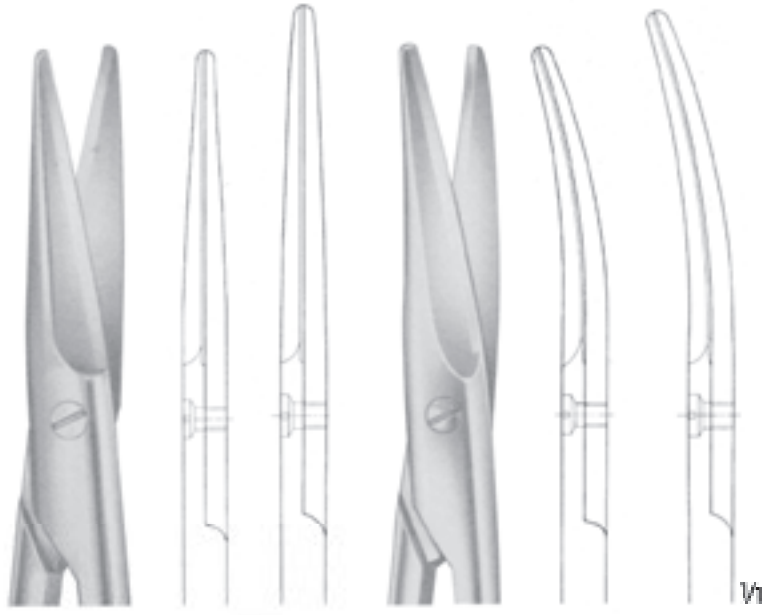

BC-5515
Düz/Straight
14 cm

BC-5517
Düz/Straight
17 cm

BC-5615
Eğri/Curved
14 cm

BC-5617
Eğri/Curved
17 cm



BC-5512
Cerrahi makas/Surgical scissors
14.5 cm

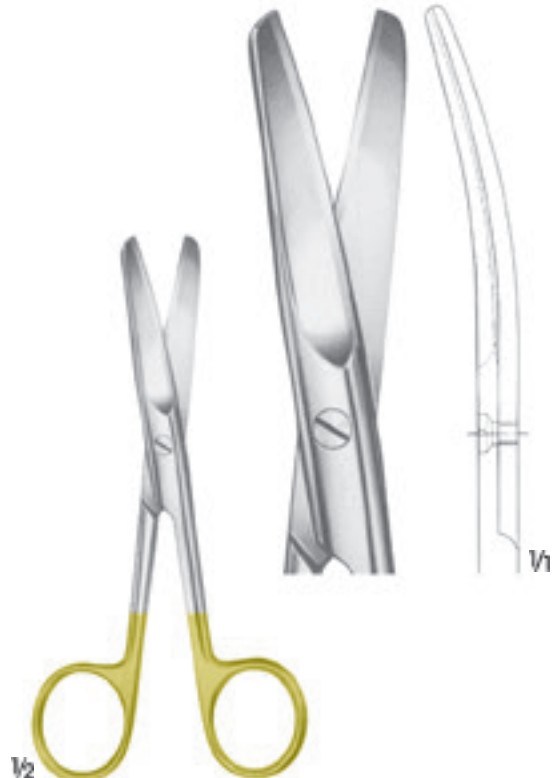

BC-5513
Cerrahi makas/Surgical scissors
14.5 cm





MAYO
BC-5621 - BC-5633



BC-5621
17 cm



BC-5623
23 cm



BC-5631
17 cm



BC-5633
23 cm

Super Cut



LEXER
BC-5635
Dar/Narrow
16.5 cm



Super Cut



MAYO-LEXER
BC-5640
16.5 cm





WERTHEIM
BC-5645 - BC-5650
Diseksiyon makasları/Dissecting scissors

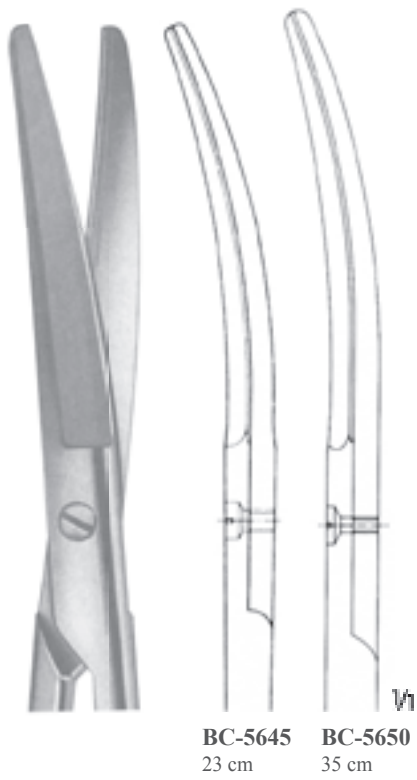

BC-5645 23 cm
BC-5650 35 cm

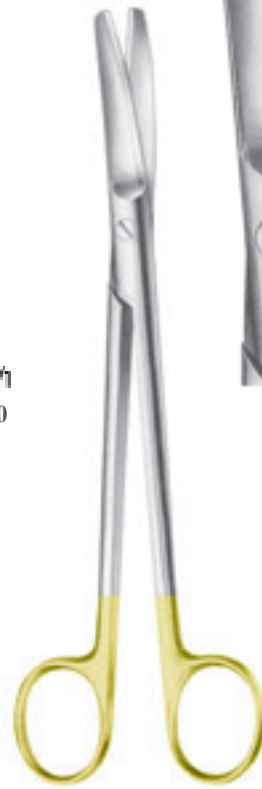

SIMS
BC-5655 - BC-5659
Rahim makasları/Uterine Scissors



BC-5655 20 cm
BC-5657 23 cm
BC-5659 35 cm





Tek ağız tırtıllı
One jaw serrated



BC-7015
Tel kesme makası
Wire cutting scissors
12 cm



60°



DE BAKEY
BC-6522
Damar makası
Vascular scissors
22 cm

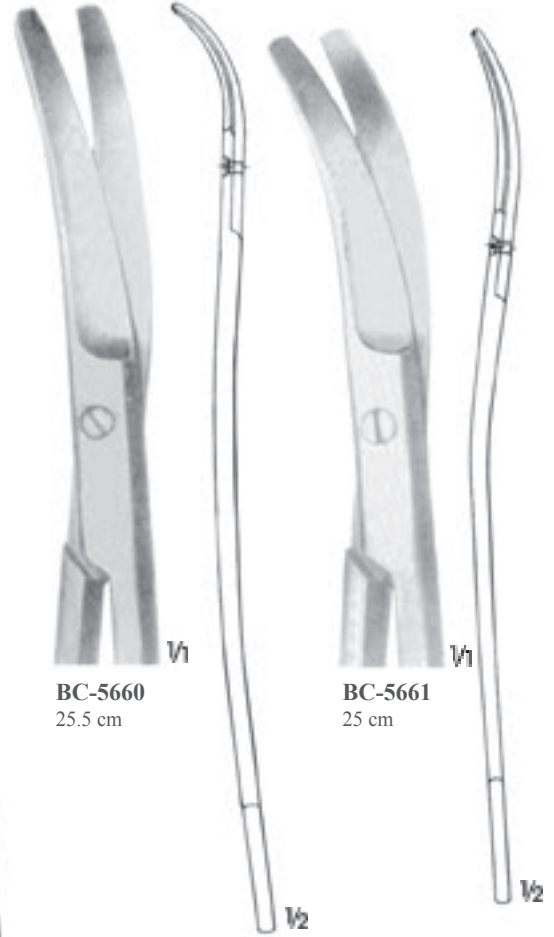

BC-5660
25.5 cm

BC-5661
25 cm



BC-5660 - BC-5661
Histerektomi makasları
Hysterectomy scissors



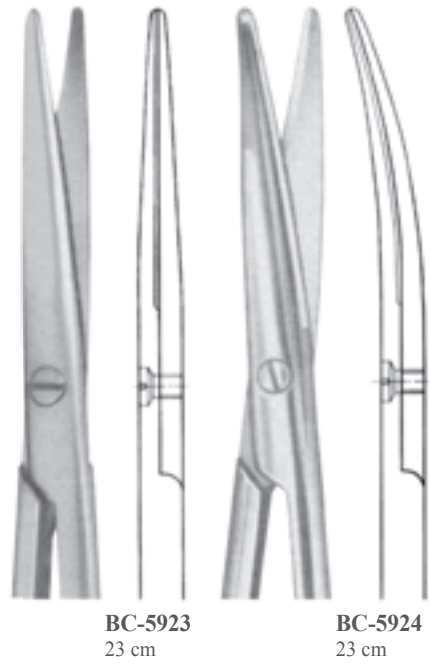

BC-5923
23 cm

BC-5924
23 cm

NELSON-METZENBAUM (MC INDOE)
BC-5923 - BC-5924



BC-5930
30 cm

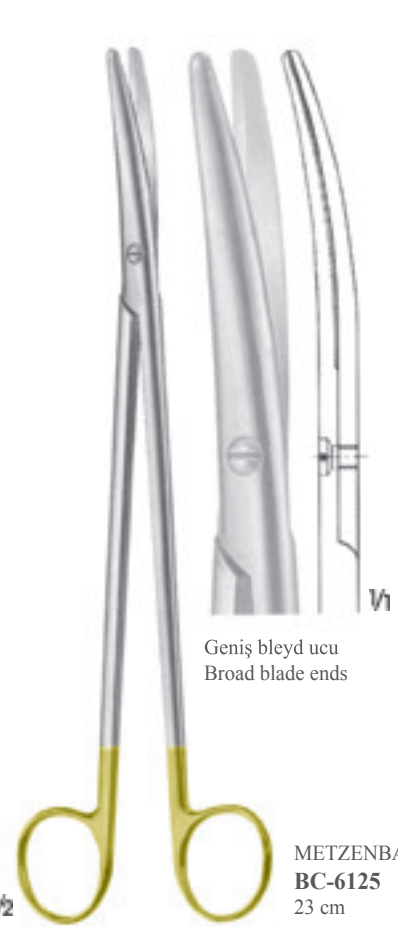

BC-6125
23 cm

METZENBAUM

Geniş bleyd ucu
Broad blade ends



Super Cut

BC-6130
26 cm

BC-6140
28 cm

BC-6160
28.5 cm

NELSON-METZENBAUM
BC-6130 - BC-6160

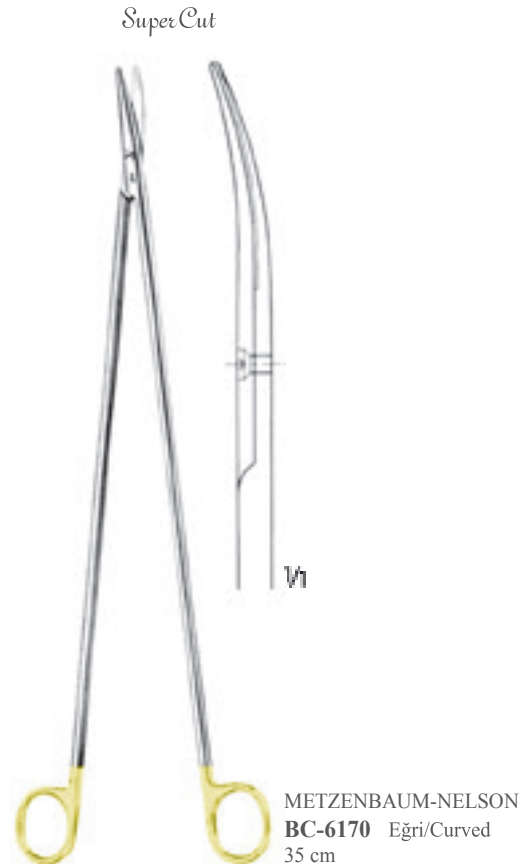
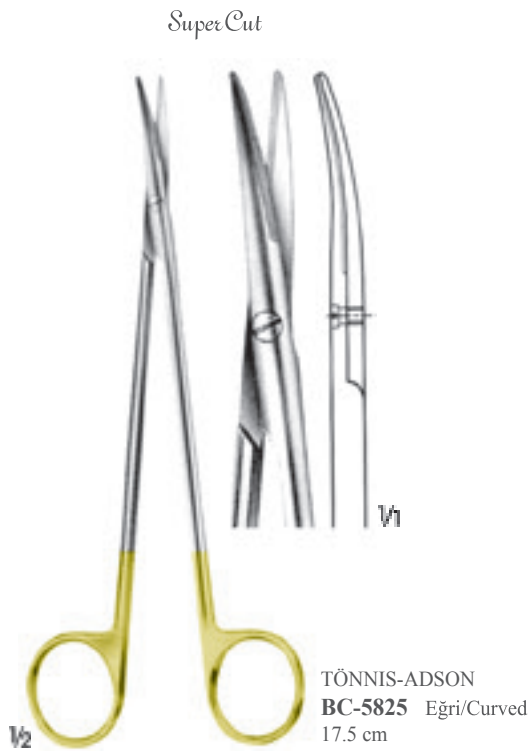



Dikiş malzemelerinin kesimi için ;

- **PerfectCut** makasın üzerindeki karbid uçları kalıcı keskinlik sağlar. (Makas ağzının uçları da dahil)
- **PerfectCut** makasın üzerindeki Tırtıklı ağız dikiş malzemelerinin dışarıya kaymasını engeller.

Cutting suture materials;

- Carbide inserts on **PerfectCut** scissors provide lasting sharpness. (including tip of the blades of the scissors)
- Serrated edges on **PerfectCut** scissors prevents suture materials from slipping out.



BC-6205
BC-6200 - BC-6204

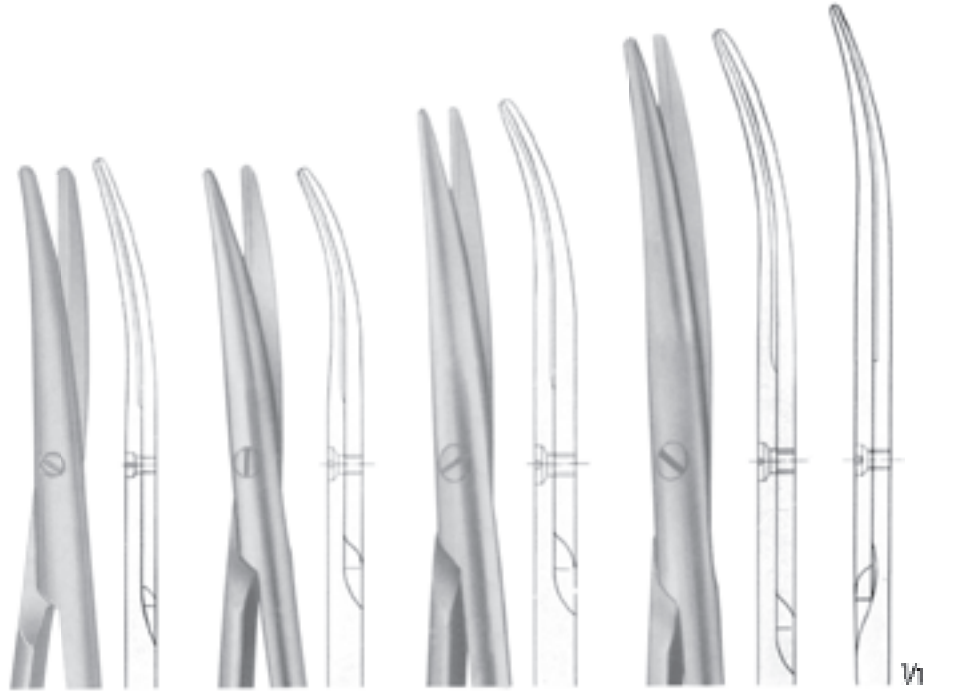

BC-6205
Tek ağız tırtıllı
One jaw serrated
14.5 cm

BC-6200
Tek ağız tırtıllı
One jaw serrated
18 cm

BC-6202
Tek ağız tırtıllı
One jaw serrated
23 cm

BC-6203
Tek ağız tırtıllı
One jaw serrated
26 cm

BC-6204
Tek ağız tırtıllı
One jaw serrated
35 cm

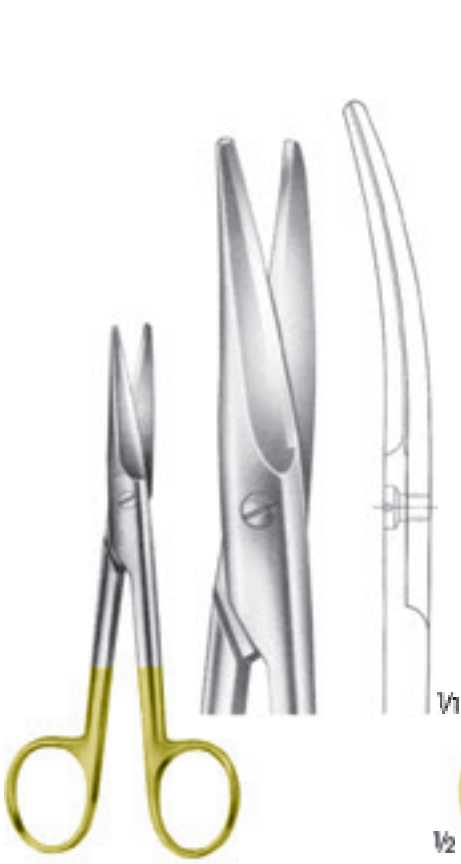

MAYO
BC-5618
Diseksiyon makası
Dissecting scissors
17 cm

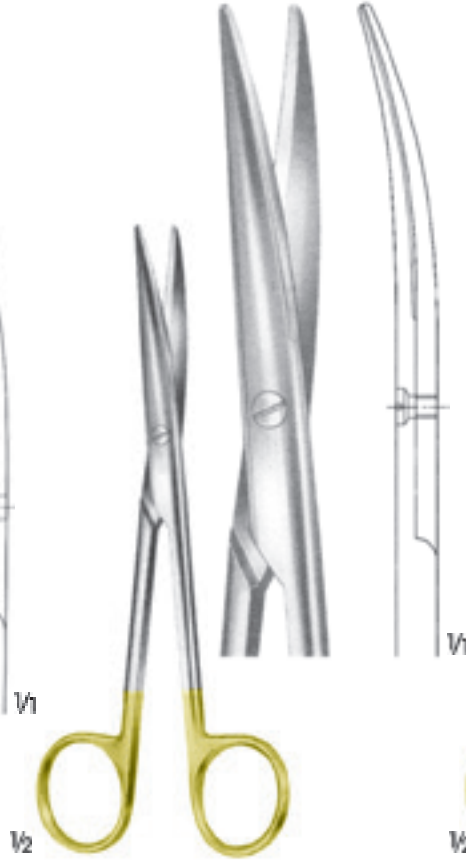

LEXER
BC-5636
İnce diseksiyon makası
Dissecting scissors, slender
16.5 cm

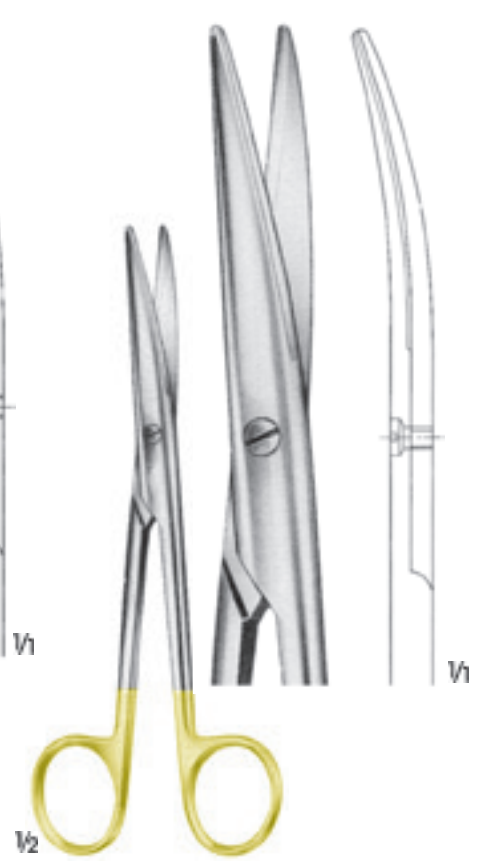

MAYO-LEXER
BC-5641
Diseksiyon makası
Dissecting scissors
16.5 cm

Super Cut



BC-5397
Ligatür makası/Ligature scissors
Eğri/Curved
11 cm

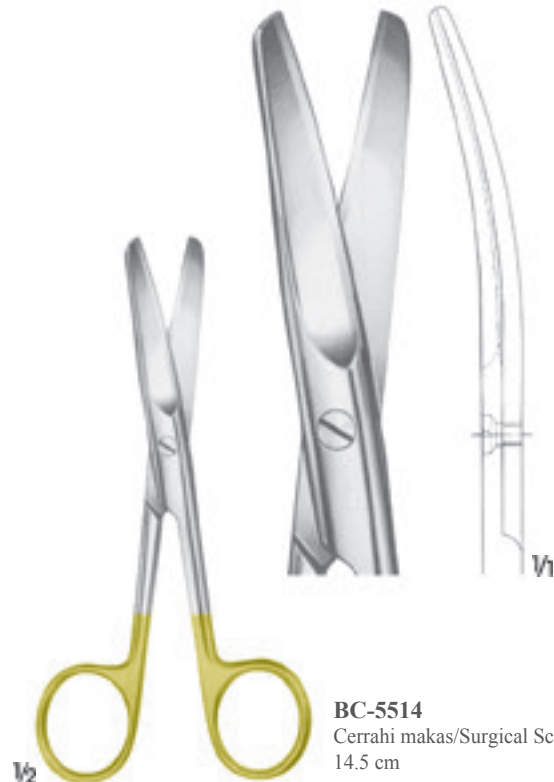

BC-5514
Cerrahi makas/Surgical Scissors
14.5 cm



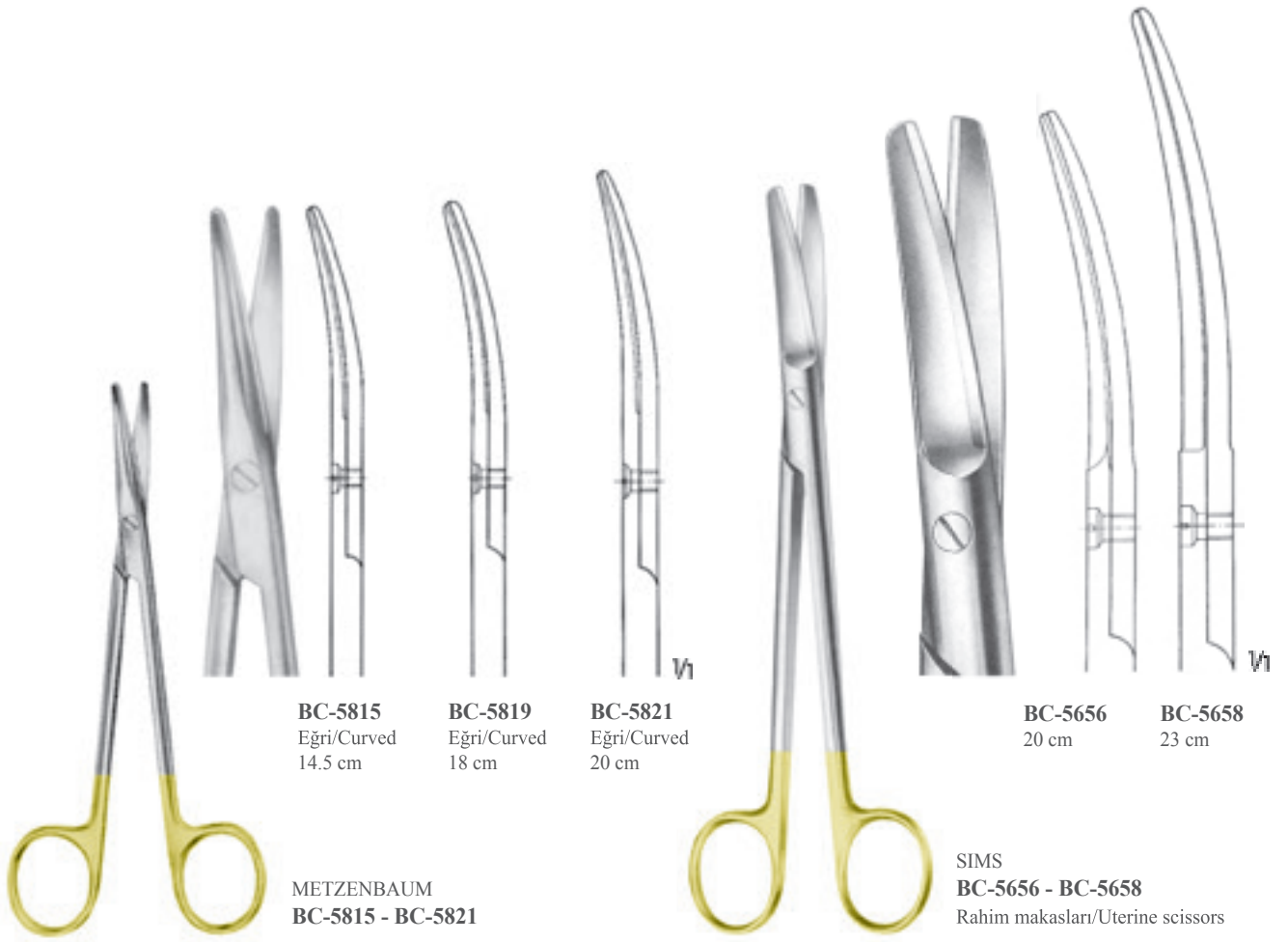

BC-5815
Eğri/Curved
14.5 cm

BC-5819
Eğri/Curved
18 cm

BC-5821
Eğri/Curved
20 cm

BC-5656
20 cm

BC-5658
23 cm

METZENBAUM
BC-5815 - BC-5821

SIMS
BC-5656 - BC-5658
Rahim makasları/Uterine scissors

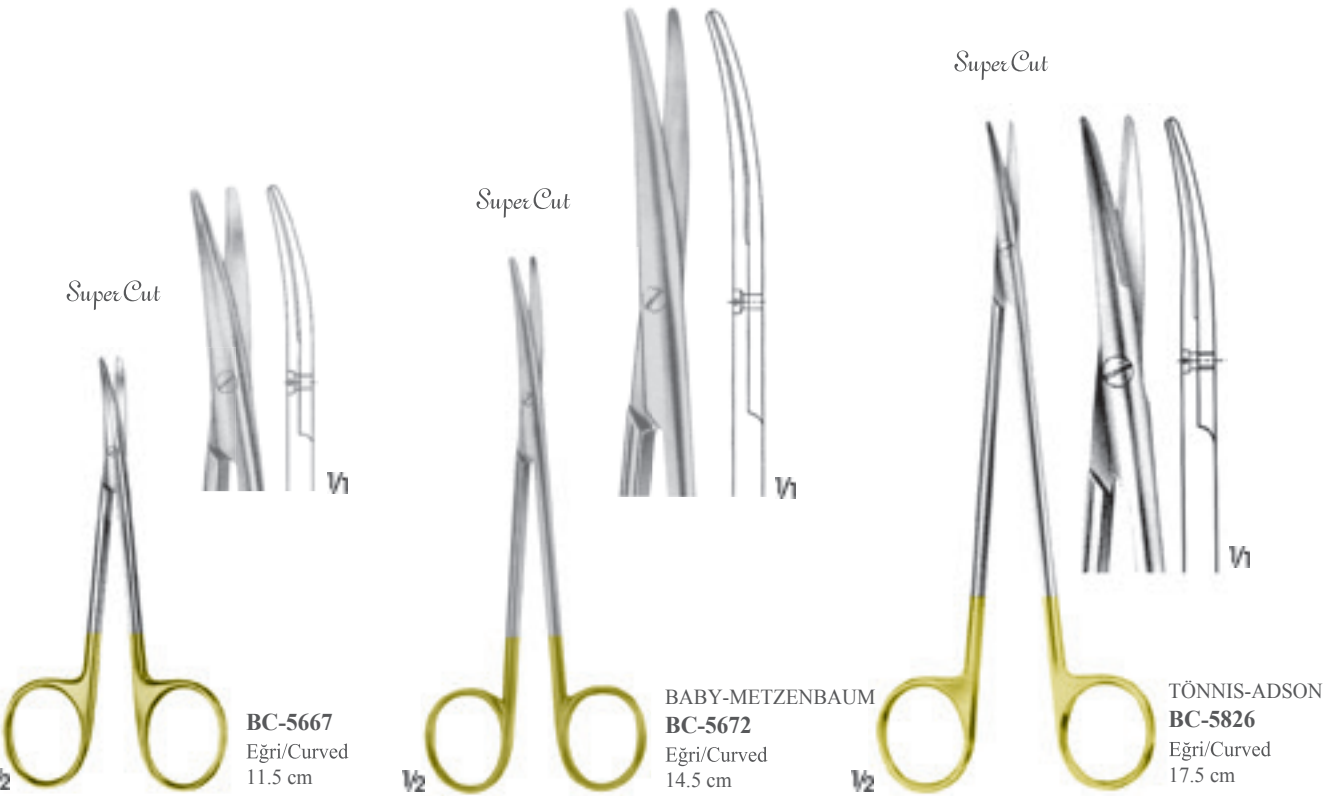

SuperCut

SuperCut

SuperCut

BC-5667
Eğri/Curved
11.5 cm

BABY-METZENBAUM
BC-5672
Eğri/Curved
14.5 cm

TÖNNIS-ADSON
BC-5826
Eğri/Curved
17.5 cm

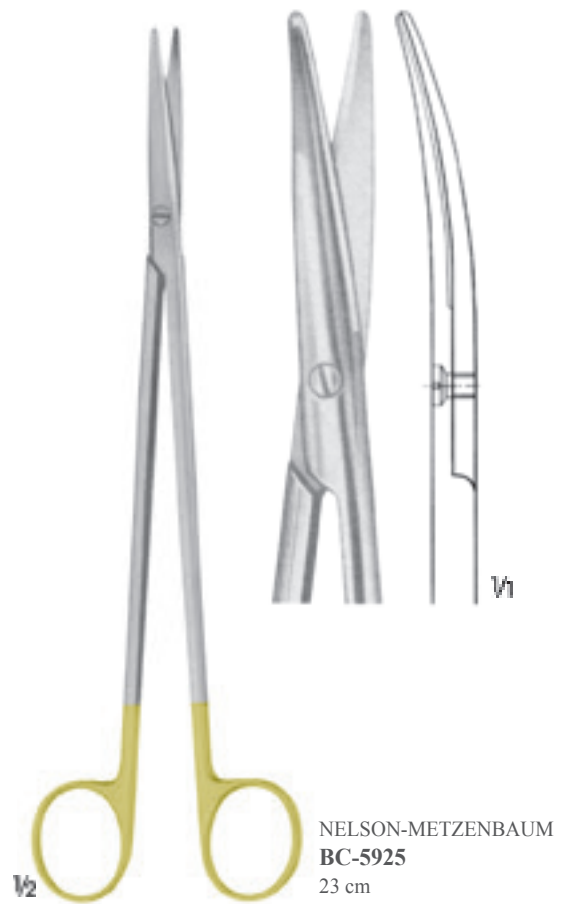
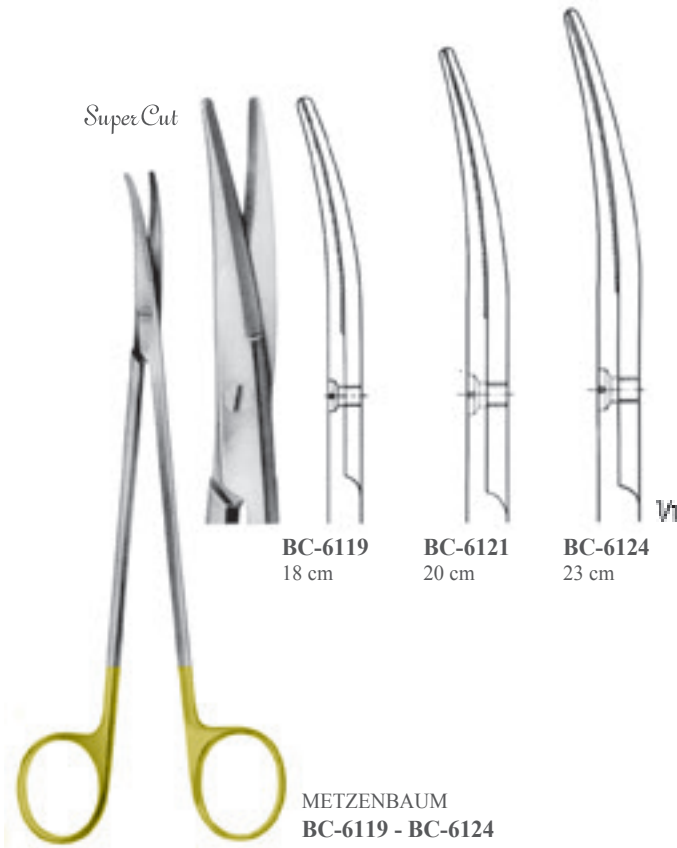
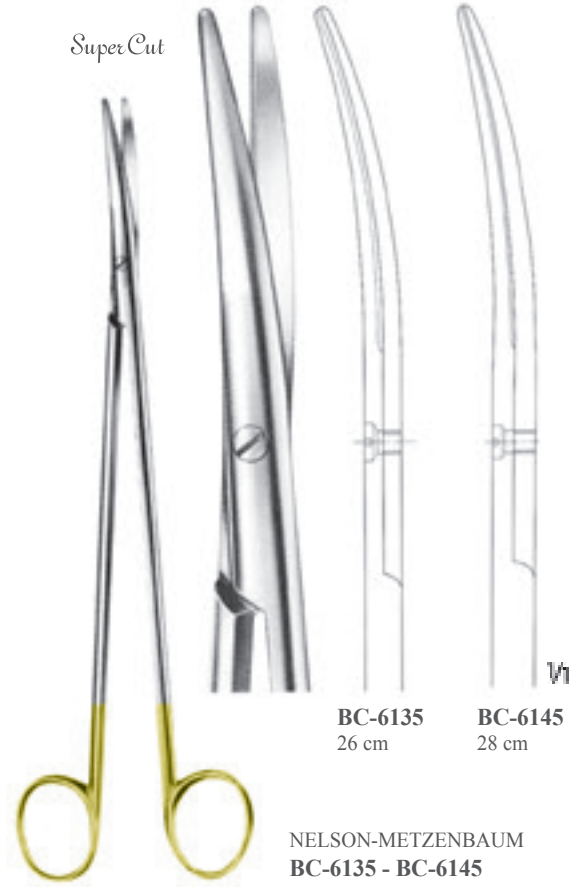
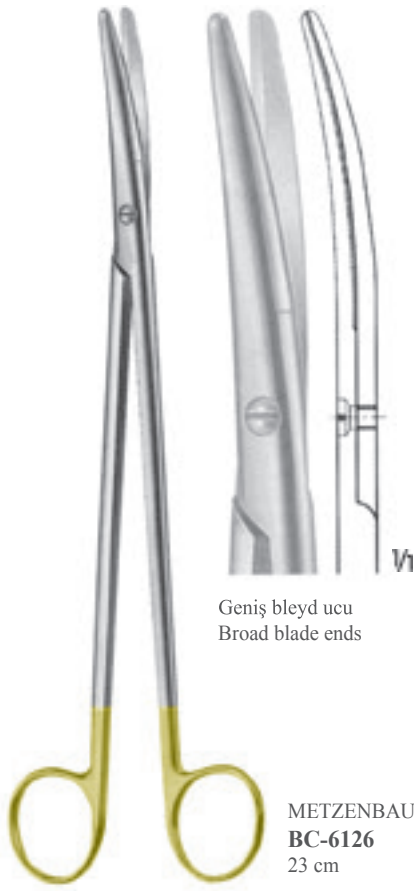



Dikiş malzemelerinin kesimi için ;

- **PerfectCut** makasın üzerindeki karbid uçları kalıcı keskinlik sağlar. (Makas ağzının uçları da dahil)
- **PerfectCut** makasın üzerindeki Tırtıklı ağız dikiş malzemelerinin dışarıya kaymasını engeller.

Cutting suture materials;

- Carbide inserts on **PerfectCut** scissors provide lasting sharpness. (including tip of the blades of the scissors)
- Serrated edges on **PerfectCut** scissors prevents suture materials from slipping out.

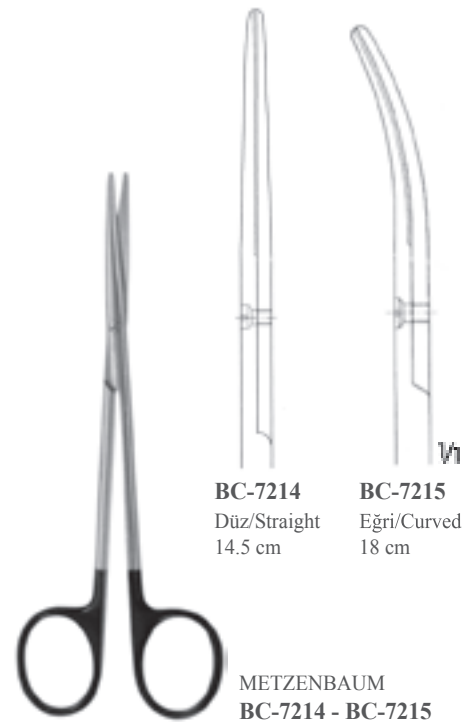
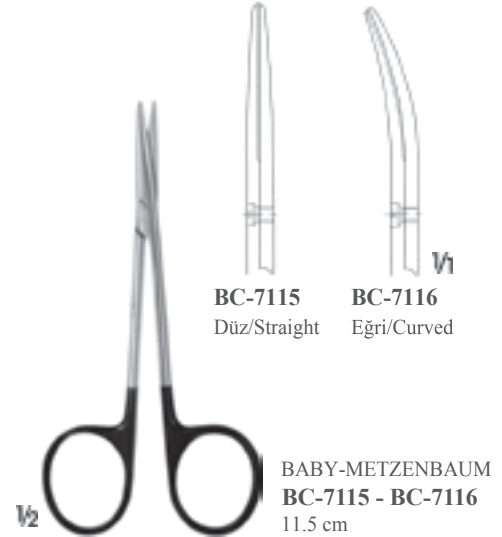
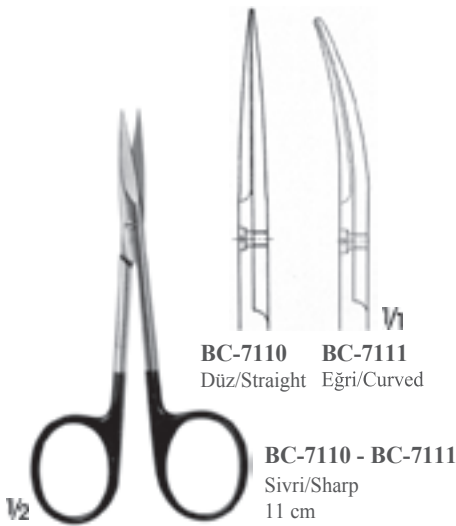

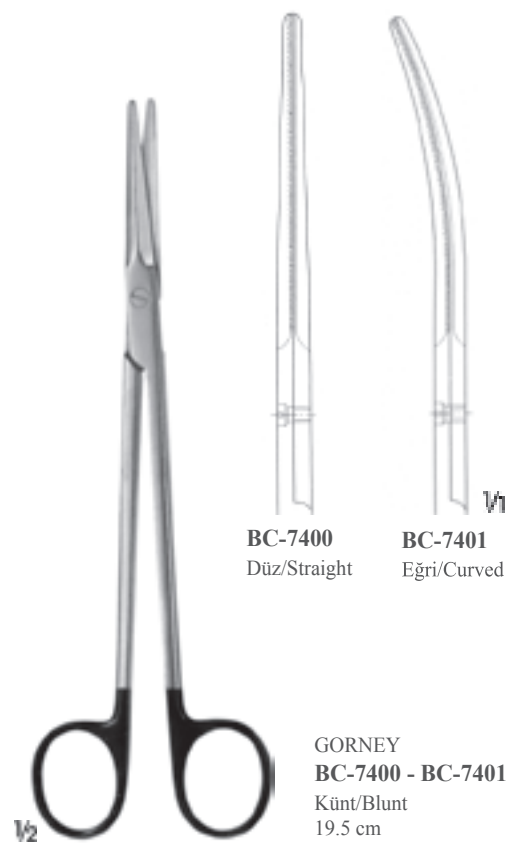
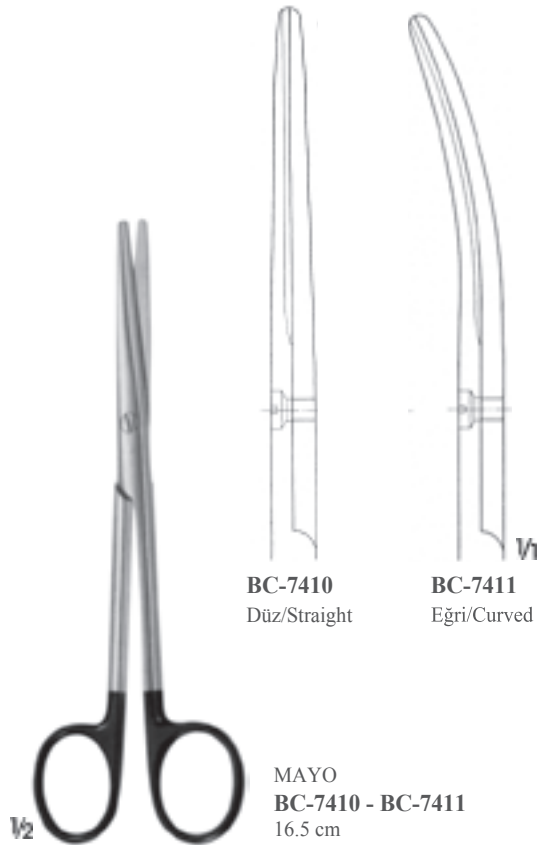
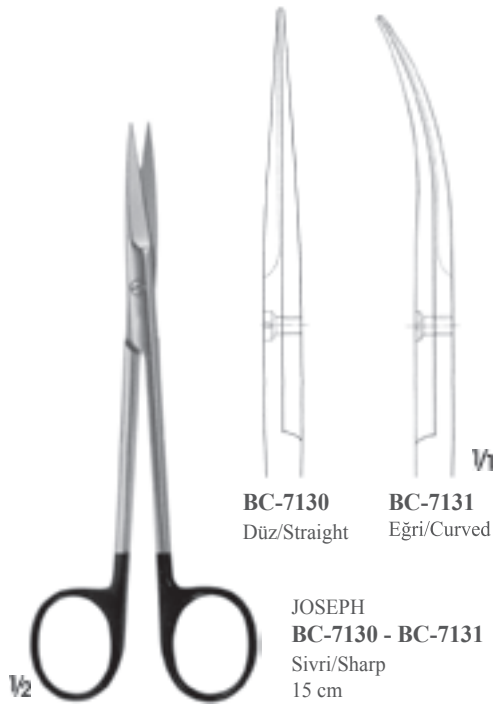



Super Cut

Super Cut

BC-6314 14.5 cm **BC-6318** 18 cm **BC-6320** 20 cm **BC-6418** 18 cm **BC-6420** 20 cm

METZENBAUM
BC-6314 - BC-6420

Super Cut

BC-6516 **BC-6517**

MAYO-LEXER
BC-6516 - BC-6517
16.5 cm

Super Cut

BC-6201 11.5 cm

Super Cut

BC-6206 14.5 cm

BABY-METZENBAUM
BC-6206
14.5 cm



PerfectCut kesme sırasında dokunun kaymasını engeller.

PerfectCut prevents tissue from slipping out during the cutting process

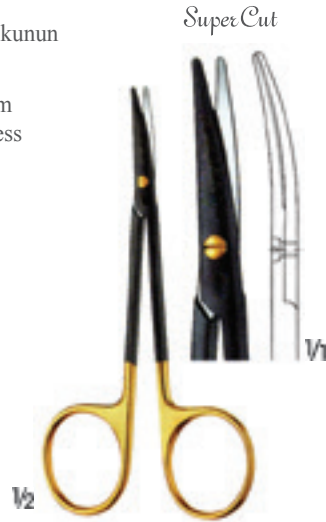

BC-6611
Tek ağız tırtıllı/One jaws serrated
11.5 cm



BC-6615
Tek ağız tırtıllı/One jaws serrated
14.5 cm



BC-6714 14.5 cm
BC-6718 18 cm
BC-6720 20 cm
BC-6818 18 cm
BC-6820 20 cm

METZENBAUM
BC-6714 - BC-6820
Tek ağız tırtıllı/One jaws serrated



BC-6900 16.5 cm
BC-6901 16.5 cm

MAYO-LEXER
BC-6900 - BC-6901
Tek ağız tırtıllı/One jaws serrated



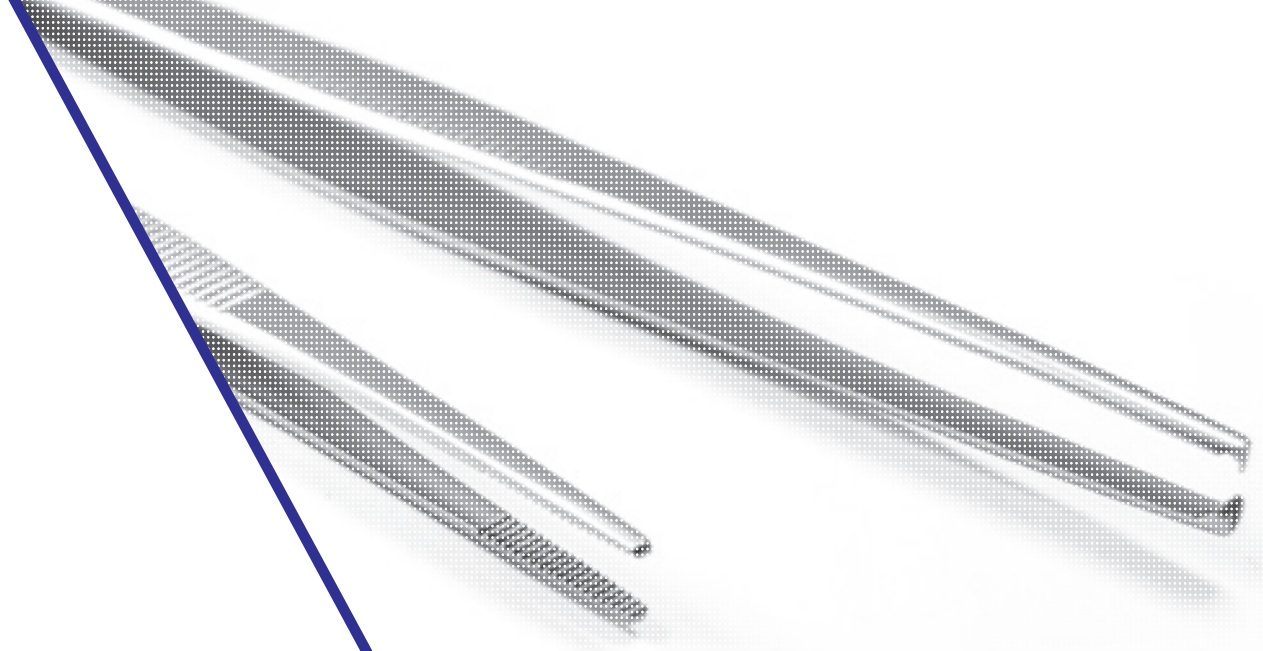

BD

Pensetler
Forceps





BD-1111
Mikro penset
Micro forceps
13.5 cm



BD-1112
Mikro penset
Micro forceps
1 x 2 diş/1 x 2 teeth
13.5 cm



BD-2550
Hassas diseksiyon penseti
Delicate dissecting forceps
10 cm



BD-2551
Hassas diseksiyon penseti
Delicate dissecting forceps
10 cm



BD-2552
Hassas diseksiyon penseti
Delicate dissecting forceps
10 cm

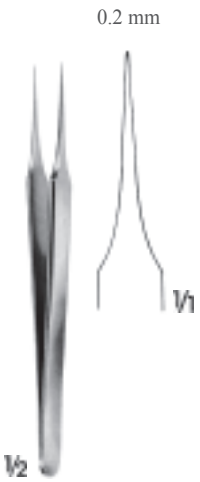

BD-1103
Mikro penset
Micro forceps
11 cm



BD-1105
Mikro penset
Micro forceps
11 cm



BD-1106
Mikro penset
Micro forceps
11 cm



BD-1108
Mikro penset
Micro forceps
11.5 cm



BD-1109
Mikro penset
Micro forceps
1 x 2 diş
1 x 2 teeth
11.5 cm

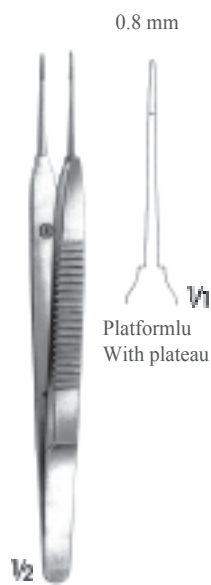

AUSTIN
BD-1140
14 cm

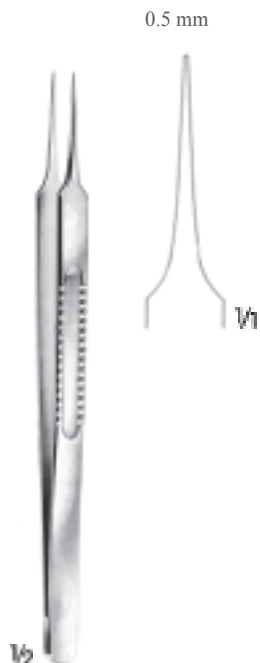

LAZAR
BD-1150
15.5 cm



LAZAR
BD-1180
15.5 cm

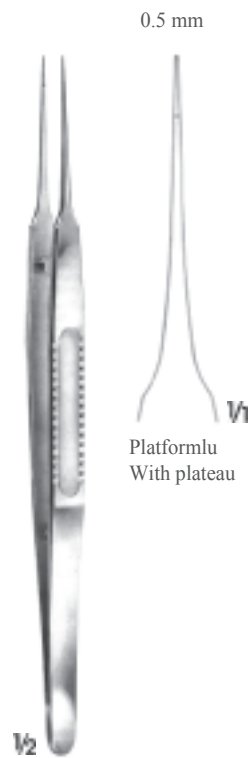

BD-1145
18.5 cm



BONNER MODELL
BD-1135
1 x 2 dişli platform
With plateau 1 x 2 teeth
9.5 cm

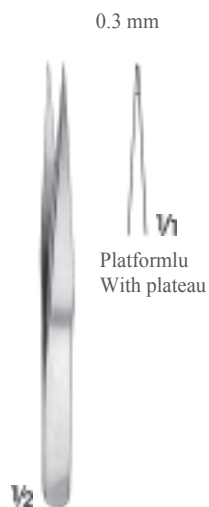

BD-1110
12 cm



VISE
BD-1113
13.5 cm

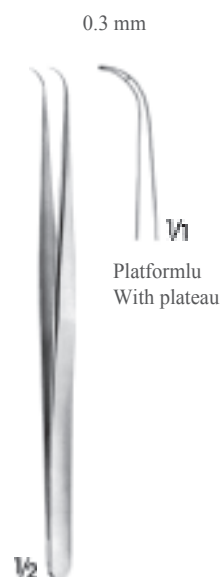

VISE
BD-1114
13.5 cm





Kavrama yüzeyini artıran hafif plastik tutamak :

- Kramp oluşturmeyen, doğal tutma pozisyonu ve duyarlılık sağlar.
- Yuvarlak tutma kesiti aletin kolay ve düzgün rotasyonunu sağlar. Böylelikle uygulama ve çalışma alanı genişler.
- Pimli tutma profili güvenli tutmayı garanti eder.
- Ergonomik, hafif plastik sap yorulmadan optimum kullanım sağlar.

Lightweigh plastic handles to increase grip surface:

- Provides cramp free ,natural holding positions and sensitivity
- Round cross-section of the instrument provides an easy and smooth rotation.Expands the working and application area.
- Retention profile with pin ensures safe griping.
- Ergonomic, light weight plastic handle provides fatgue free, optimal usage.



MÜLLER
BD-1121 0.3 mm
16 cm



MÜLLER
BD-1122 0.5 mm
1 x 2 diş/1 x 2 teeth
16 cm



MÜLLER
BD-1123 Ø 1.2 mm
16 cm



MÜLLER
BD-1124 0.4 mm
16 cm

0.15 mm

0.2 mm

0.3 mm

0.5 mm

Ø 1.2 mm

1.2 mm



MÜLLER
BD-1125 - BD-1127
11 cm



BD-1125



BD-1126



BD-1127



MÜLLER
BD-1128
11 cm



1 x 2 diş
1 x 2 teeth



MÜLLER
BD-1129
11 cm



W1



MÜLLER
BD-1130
11 cm



W1



BD-1330
Mikro halka penset
Micro ring forceps
18 cm

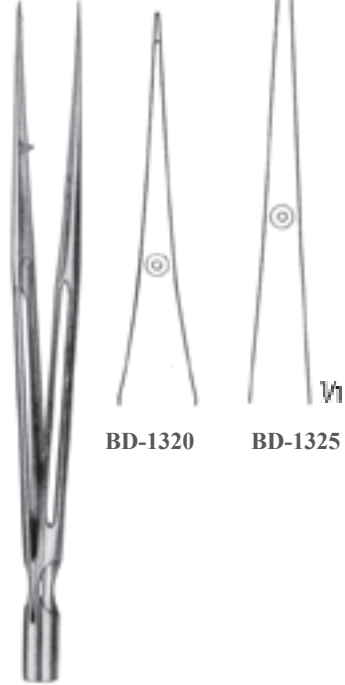

BROCK
BD-1320 15 cm
BD-1325 18 cm



BD-1476
Yuvarlak saplı mikro penset
Micro forceps with round handle
20 cm



GERALD
BD-1480 18 cm
BD-1484 25 cm
Düz saplı penset
Forceps with flat handle

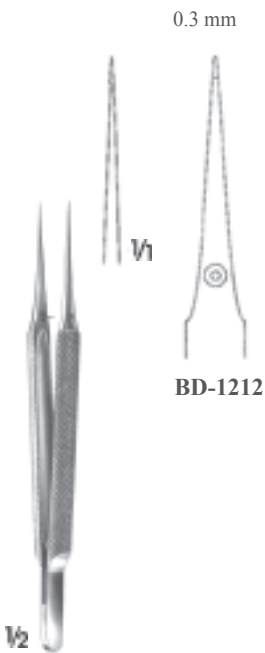

BD-1212 - BD-1312
12 cm



BD-1312



BD-1215 - BD-1315
15 cm



BD-1215



BD-1315



BD-1218 - BD-1318
18 cm



BD-1218



BD-1318





V2
MICRO-ADSON
BD-1510
15 cm

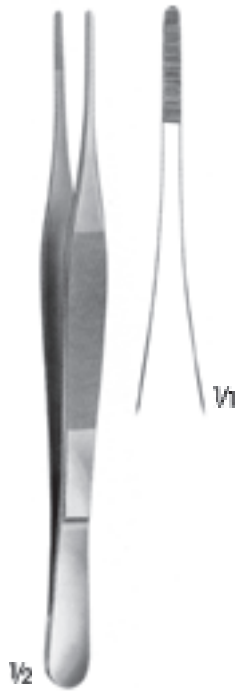

V2
ADSON
BD-1518
18 cm



V2
JEFFERSON
BD-1519
18 cm

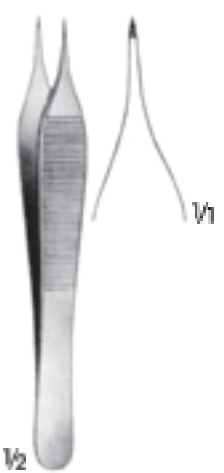

V2
THORPE
BD-1485
Kornea Penseti
Corneal forceps
12 cm



V2
MICRO-ADSON
BD-1500
12 cm

Platformlu
With plateau



V2
ADSON
BD-1505
12 cm



V2
HUDSON
BD-1506
12.5 cm

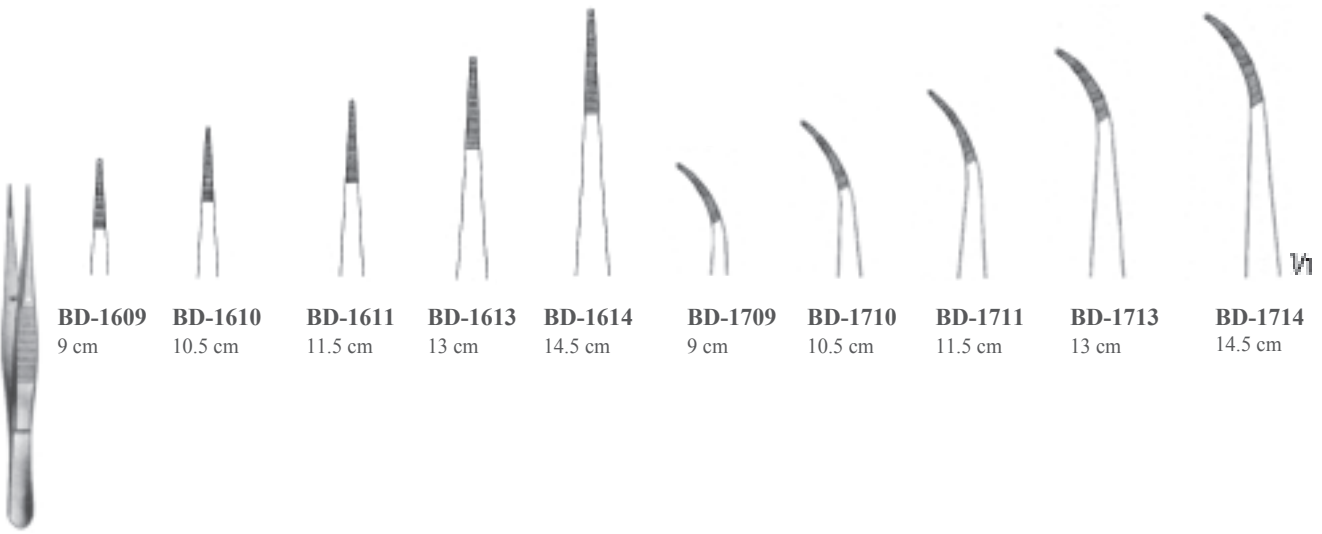

BD-1609
9 cm

BD-1610
10.5 cm

BD-1611
11.5 cm

BD-1613
13 cm

BD-1614
14.5 cm

BD-1709
9 cm

BD-1710
10.5 cm

BD-1711
11.5 cm

BD-1713
13 cm

BD-1714
14.5 cm

BD-1609 - BD-1614
BD-1709 - BD-1714

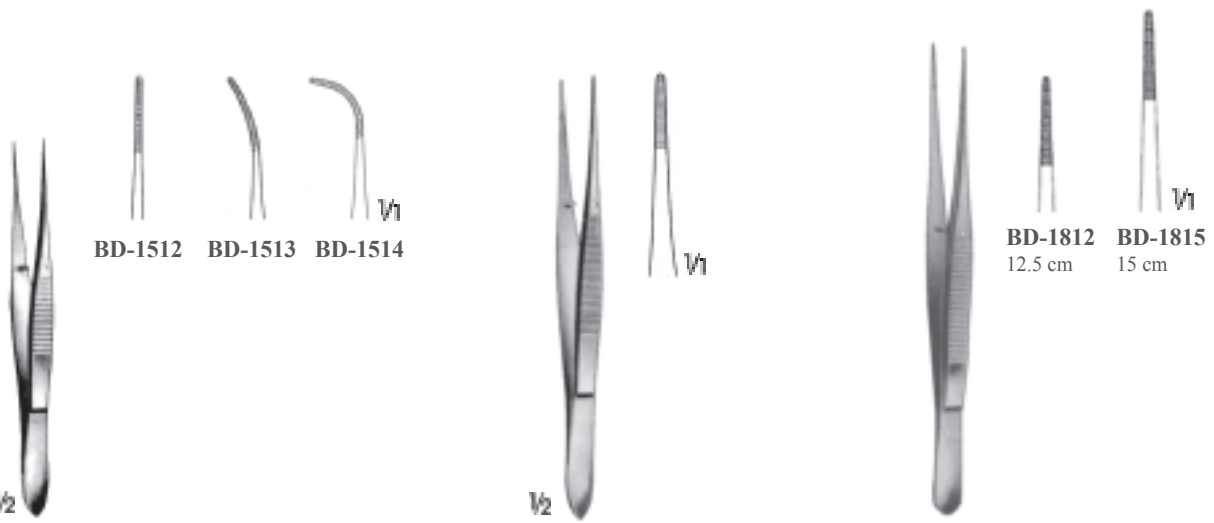

BD-1512

BD-1513

BD-1514

BD-1720
11.5 cm

SEMKEN
BD-1812 - BD-1815

BD-1812
12.5 cm

BD-1815
15 cm

BD-1512 - BD-1514
10 cm



GERALD
BD-2200 - BD-2202

BD-2200
17.5 cm



BD-2202
17.5 cm



BD-2201
23 cm



BROPHY
BD-1920 - BD-1922
20 cm



BD-1920



BD-1922



GILLIES
BD-2115
15 cm



1/1



BD-1820
15.5 cm



1/1



CUSHING
BD-1900 - BD-1905



BD-1900
18 cm



BD-1902
20 cm



BD-1904
25 cm



BD-1905
20 cm



**MC INDOE
BD-2116**
15 cm



BD-2225
17.5 cm



BD-2230
21.5 cm

**CAIRNS-DOTT
BD-2225 - BD-2230**



BD-2220
20 cm

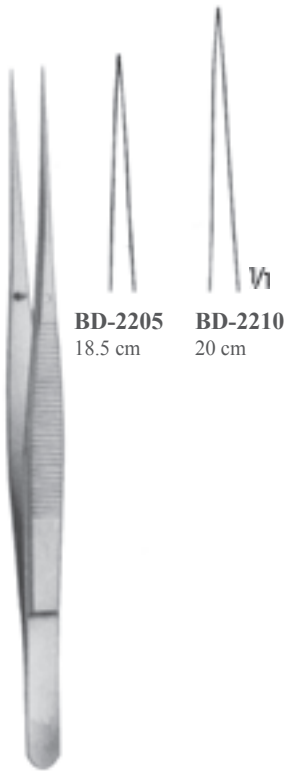

BD-2205
18.5 cm

BD-2210
20 cm

BD-2205 - BD-2210
Düz Ağz/Smooth jaws



**COOLEY
BD-1910**
20 cm



BD-2215
20 cm





BD-2011 - BD-2030
Orta/Medium

BD-2011
11.5 cm

BD-2013
13 cm

BD-2014
14.5 cm

BD-2016
16 cm

BD-2018
18 cm

BD-2020
20 cm

BD-2025
25 cm

BD-2030
30.5 cm



BD-2311 - BD-2330
Standart model/Standard pattern

BD-2311
11.5 cm

BD-2313
13 cm

BD-2314
14.5 cm

BD-2316
16 cm

BD-2318
18 cm

BD-2320
20 cm

BD-2325
25 cm

BD-2330
30 cm

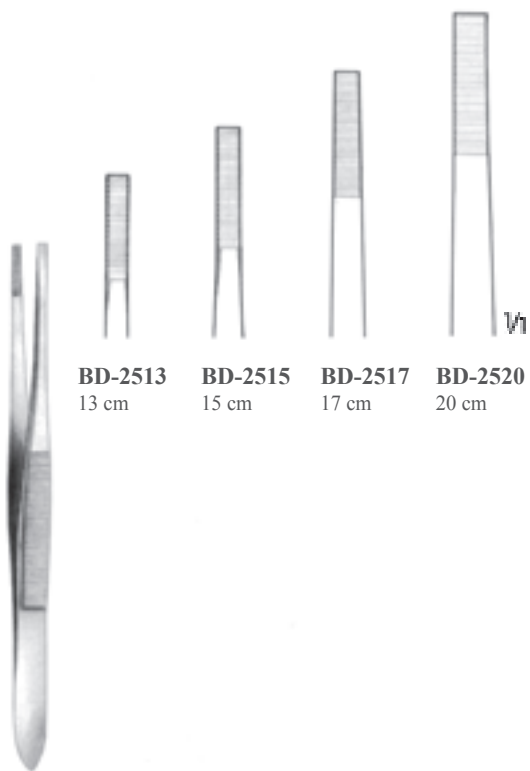

BD-2513 13 cm
BD-2515 15 cm
BD-2517 17 cm
BD-2520 20 cm

SCHWEDISCHES MODELL
BD-2513 - BD-2520
Diseksiyon pensetleri
Dissecting forceps

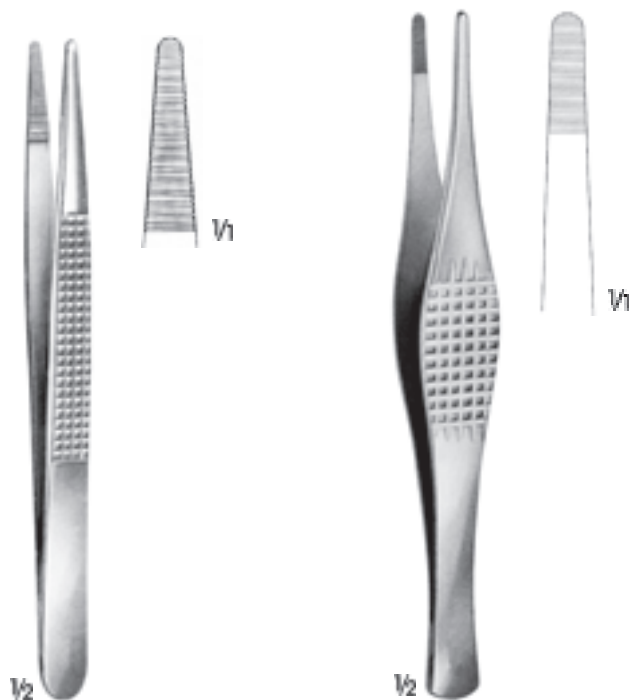

BONNEY
BD-2545
Diseksiyon penseti
Dissecting forceps
17.5 cm

RAMSEY
BD-2518
Diseksiyon penseti
Dissecting forceps
18 cm



BD-2335
Çok büyük/Extra Large
Diseksiyon penseti
Dissecting forceps
14.5 cm



OCHSNER
BD-2540
Ligatür penseti
Ligature forceps
14.5 cm

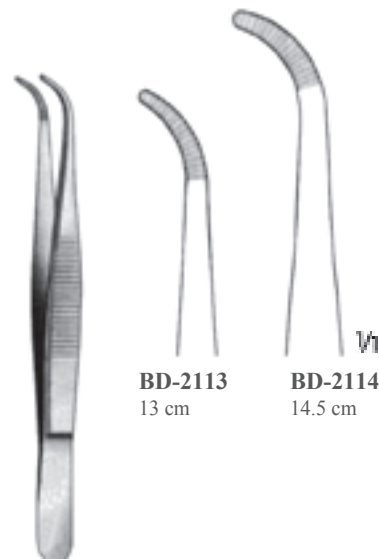

BD-2113 - BD-2114
Orta/Medium
Diseksiyon pensetleri
Dissecting forceps





De Bakey Diş



Toothing De Bakey

1.0 mm



DE BAKEY
BD-2718 18.5 cm
BD-2721 21 cm
Yuvarlak Saplı
With round handle
Mikro pensetler
Micro forceps

1.0 mm



DE BAKEY
BD-3118 18.5 cm
BD-3121 21 cm
Yuvarlak saplı
With round handle
Mikro pensetler
Micro forceps

1.0 mm



DE BAKEY
BD-2618 18 cm
BD-2620 20 cm
Düz saplı
With flat handle
Mikro pensetler
Micro forceps

1.0 mm

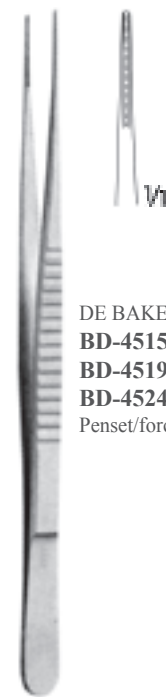

DE BAKEY
BD-4515 15 cm
BD-4519 19.5 cm
BD-4524 24 cm
Penset/forceps

2 mm



DE BAKEY
BD-4615 15 cm
Penset/forceps

40°

1.5 mm

2 mm

2.3 mm

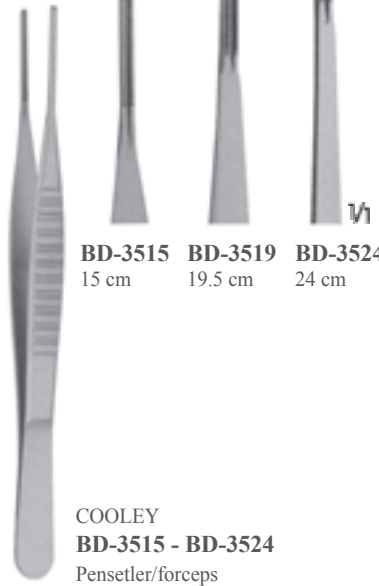

BD-3515 15 cm
BD-3519 19.5 cm
BD-3524 24 cm

COOLEY
BD-3515 - BD-3524
Pensetler/forceps

1.2 mm



BD-3215
15 cm

1.5 mm



BD-3220
20 cm

1.5 mm



BD-3224
24 cm

1.5 mm



BD-3230
30 cm

BD-3215 - BD-3230
Ultra hafif pensetler
Ultra-Light forceps

De Bakey Diş



Toothing De Bakey

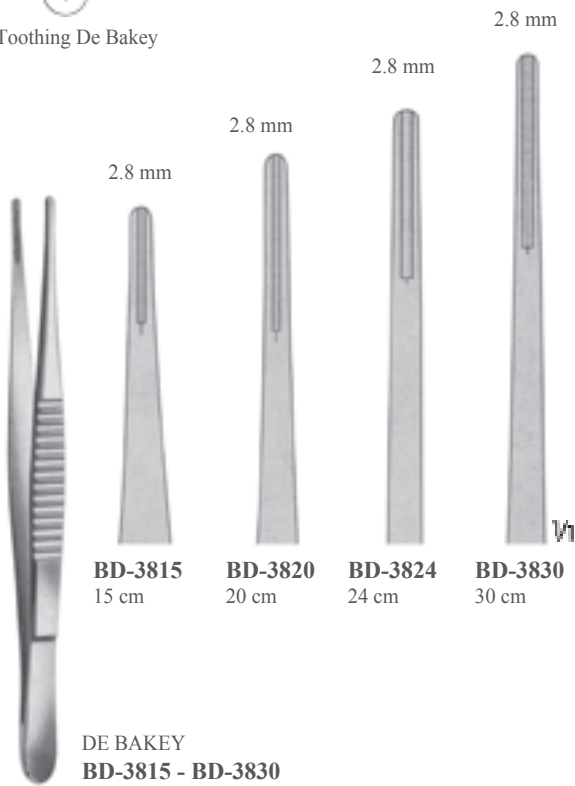

DE BAKEY
BD-3815 - BD-3830

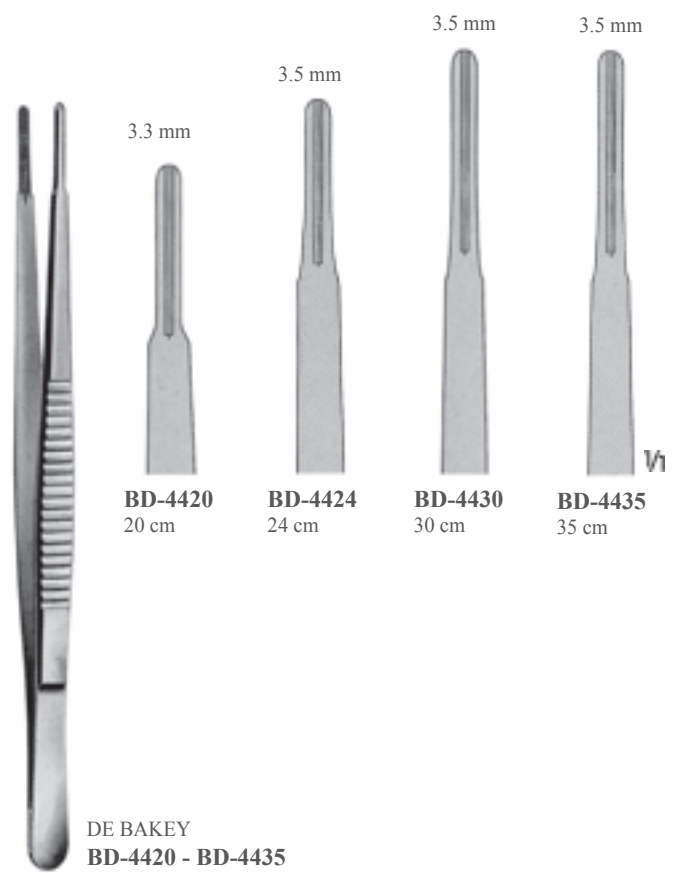

DE BAKEY
BD-4420 - BD-4435

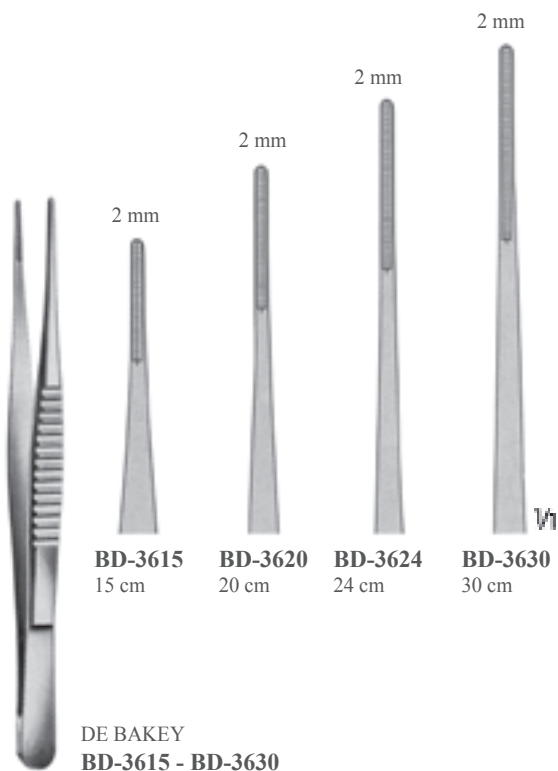

DE BAKEY
BD-3615 - BD-3630

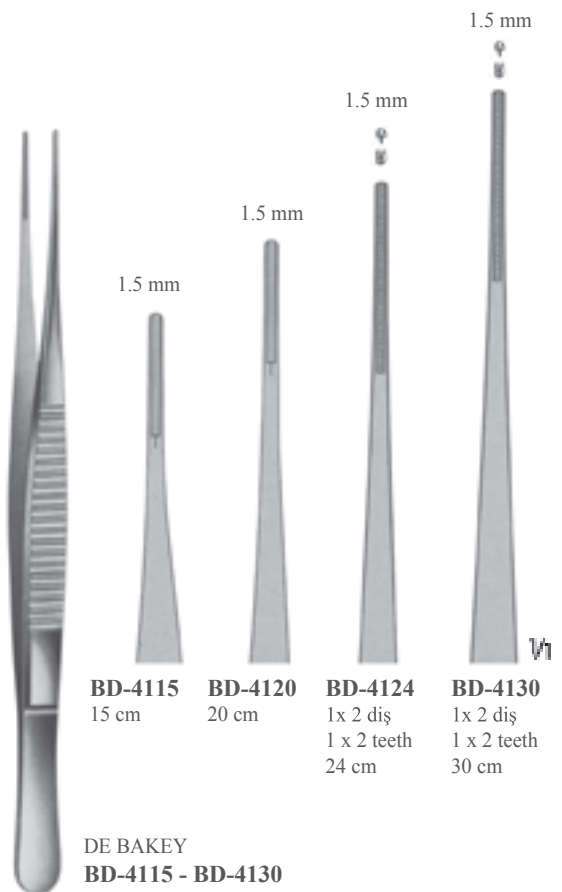

DE BAKEY
BD-4115 - BD-4130







BD-1419 BD-1420

YASARGIL
BD-1419 - BD-1420
22 cm



BD-1421 BD-1422

YASARGIL
BD-1421 - BD-1422
22 cm

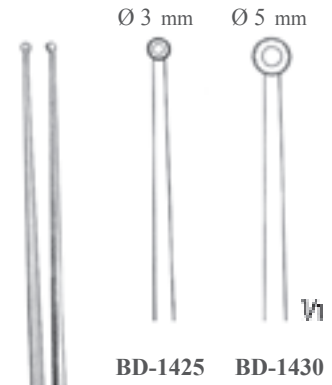

BD-1425 BD-1430

HEIFETZ
BD-1425 - BD-1430
22 cm

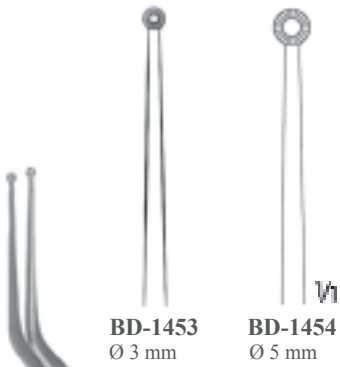

BD-1453 BD-1454
Ø 3 mm Ø 5 mm

YASARGIL
BD-1453 - BD-1454
16.5 cm

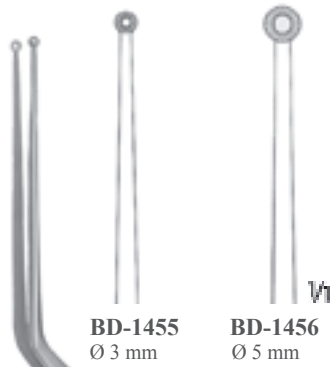

BD-1455 BD-1456
Ø 3 mm Ø 5 mm

YASARGIL
BD-1455 - BD-1456
20 cm



YASARGIL
BD-1466 45°
22 cm



BD-1467 90°
22 cm





LUCAE
BD-1395
1 x 2 diş
1 x 2 teeth
14 cm



BD-1400
1 x 2 diş
1 x 2 teeth
16 cm



BD-1401
1 x 2 diş
1 x 2 teeth
20 cm



Düz ağız
Smooth jaw

BD-1360
18.5 cm



Düz ağız
Smooth jaw

BD-1355
16 cm



Dişli ve tırtıklı
Toothed and
serrated

COTTLE
BD-1385
Penset
Forceps
14 cm



LUCAE
BD-1370
14 cm



JANSEN
BD-1375
16 cm



ADSON
BD-1350
17.5 cm



GRUENWALD
BD-1380
20 cm

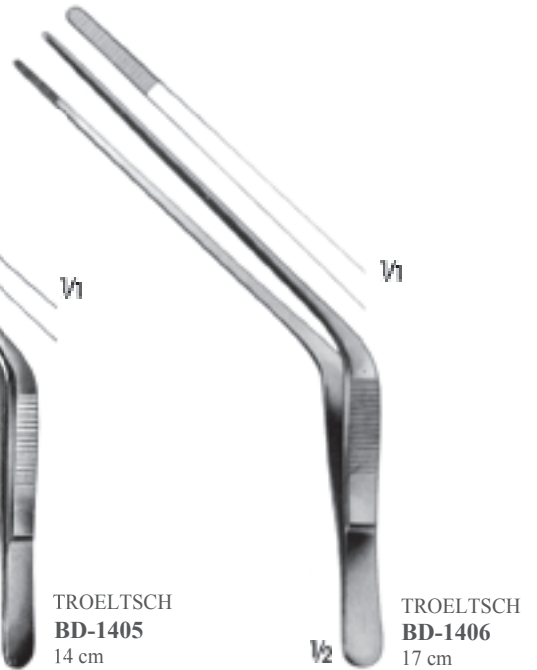
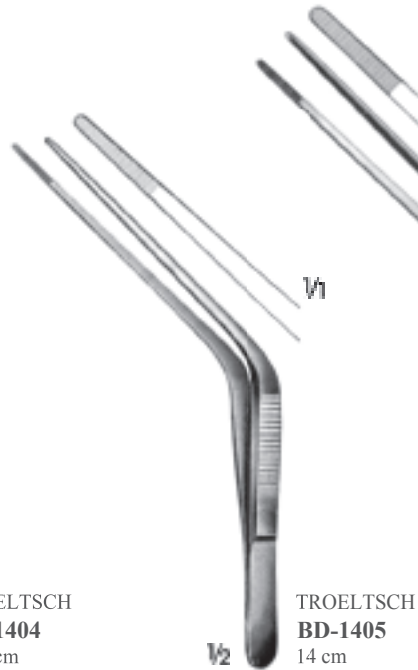
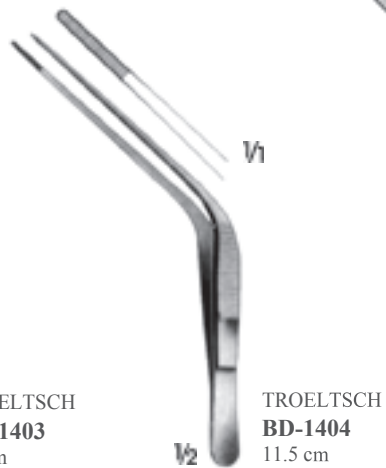
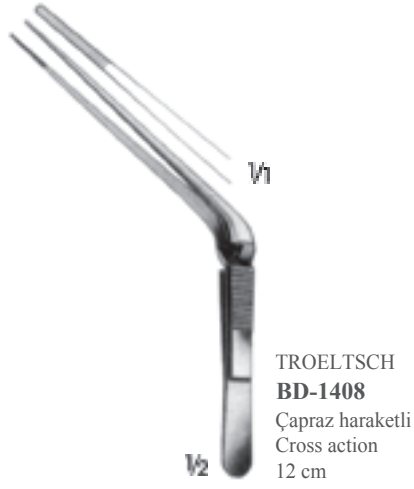

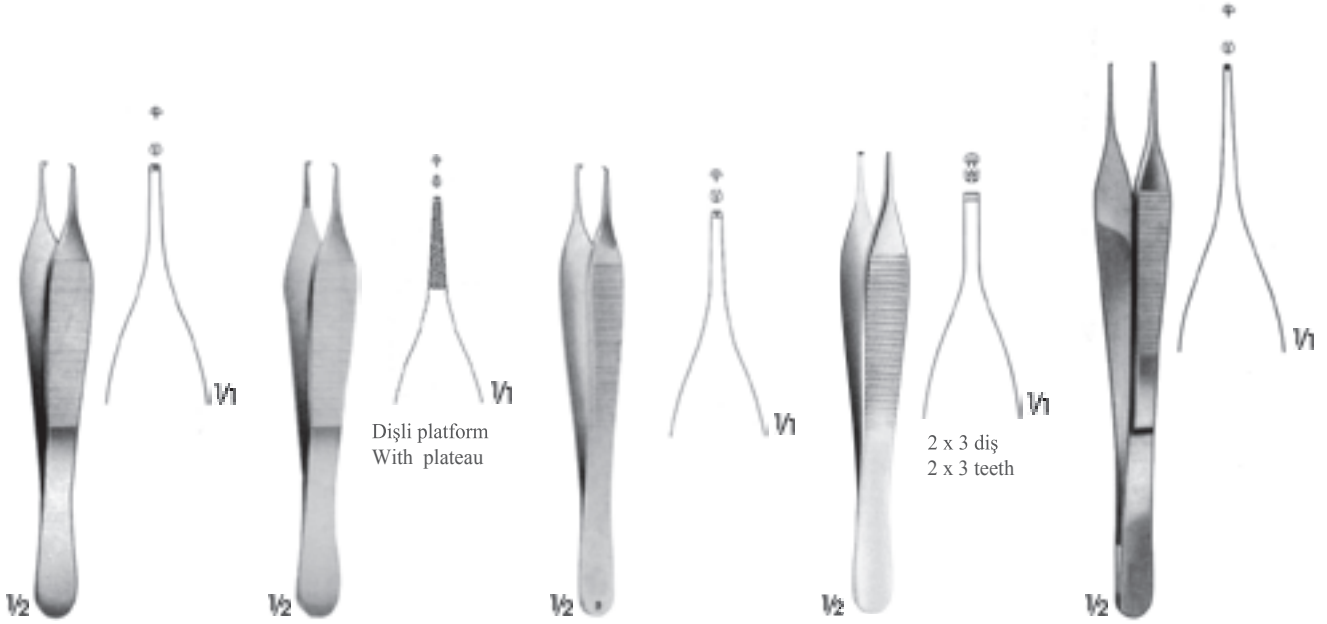

**ADSON
BD-4850**
Hassas doku penseti
Delicate tissue forceps
12 cm

**ADSON
BD-4855**
Hassas doku penseti
Delicate tissue forceps
12 cm

**HUDSON
BD-4825**
Doku penseti
Tissue forceps
12.5 cm

**ADSON
BD-4866**
Doku penseti
Tissue forceps
12 cm

**MICRO-ADSON
BD-4865**
Hassas doku penseti
Delicate tissue forceps
15 cm

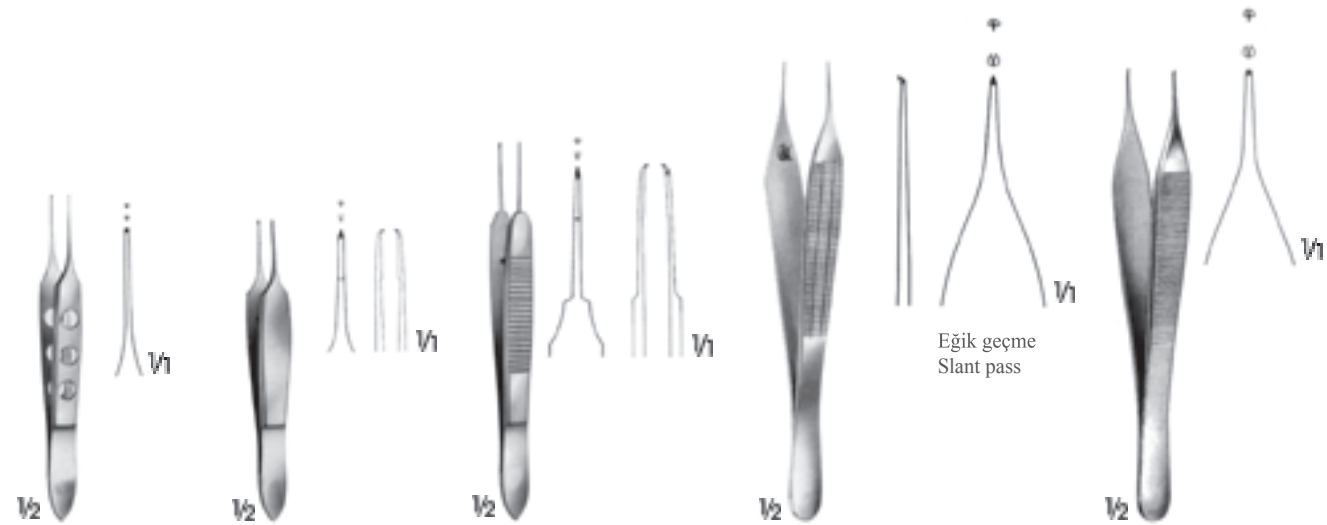

**BISHOP-HARMON
BD-1101**
Hassas göz penseti
Delicate eye forceps
8.5 cm

**ST.MARTIN
BD-1100**
Hassas göz penseti
Delicate eye forceps
8 cm

**CASTROVIEJO
BD-1102**
Hassas göz penseti
Delicate eye forceps
8 cm

**MICRO-ADSON-BIEMER
BD-4820**
Hassas doku penseti
Delicate tissue forceps
12 cm

**MICRO-ADSON
BD-4830**
Hassas doku penseti
Delicate tissue forceps
12 cm

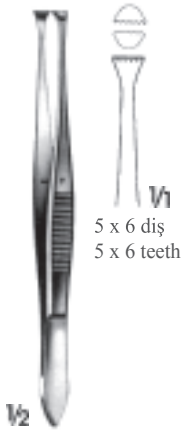

GRAEFE
BD-4900

Dişli doku penseti
Tissue forceps
11 cm



ADSON-BROWN
BD-4870

Dişli doku penseti, sivri
Tissue forceps, sharp
12 cm



BROWN
BD-4875 15 cm

Dişli doku pensetleri
Tissue forceps



BD-4885 20 cm



ADSON
BD-4868

Hassas doku penseti
Delicate tissue forceps
18 cm



JEFFERSON
BD-4869

Hassas doku penseti
Delicate tissue forceps
18 cm



ADSON
BD-4860

Hassas doku penseti
Delicate tissue forceps
12 cm



ADSON
BD-4861

Hassas doku penseti
Delicate tissue forceps
12 cm



ADSON
BD-4862

Hassas doku penseti
Delicate tissue forceps
12 cm



ADSON
BD-4863

Hassas doku penseti
Delicate tissue forceps
12 cm



ADSON
BD-4867

Hassas doku penseti
Delicate tissue forceps
15 cm



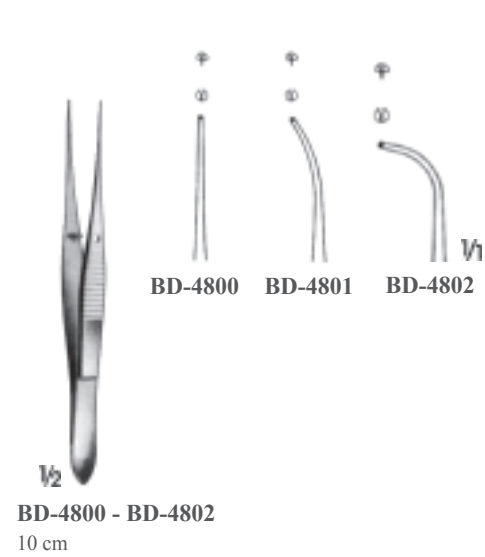
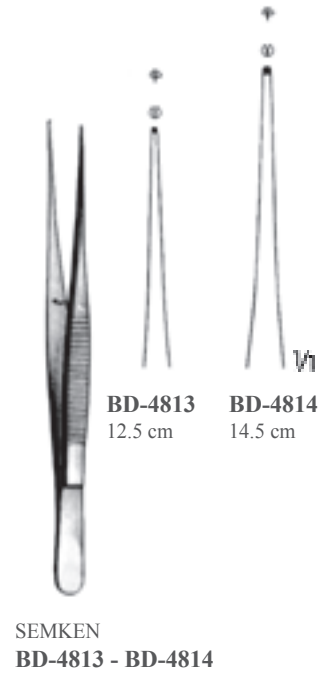
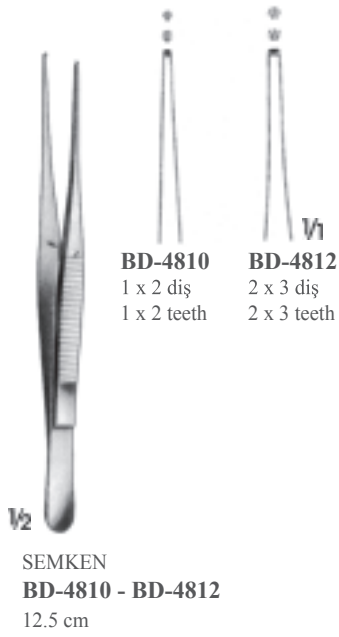



BD-5211
11.5 cm

BD-5213
13 cm

BD-5214
14.5 cm

BD-5300
14.5 cm

BD-5216
16 cm

BD-5218
18 cm

BD-5220
20 cm

BD-5225
25 cm

BD-5230
30 cm

BD-5211 - BD-5300
Orta boy/medium



BD-5010
10.5 cm

BD-5011
11.5 cm

BD-5013
13 cm

BD-5014
14.5 cm

BD-5016
16 cm

BD-5018
18 cm

BD-5020
20 cm

BD-5025
25 cm

BD-5030
30 cm

BD-5035
35 cm

BD-5010 - BD-5035
Satandart model
Standard pattern





BD-5320
Doku penseti
Tissue forceps
20 cm



BROPHY
BD-5321
Doku penseti
Tissue forceps
20 cm



CUSHING
BD-5318
Doku penseti
Tissue forceps
18 cm

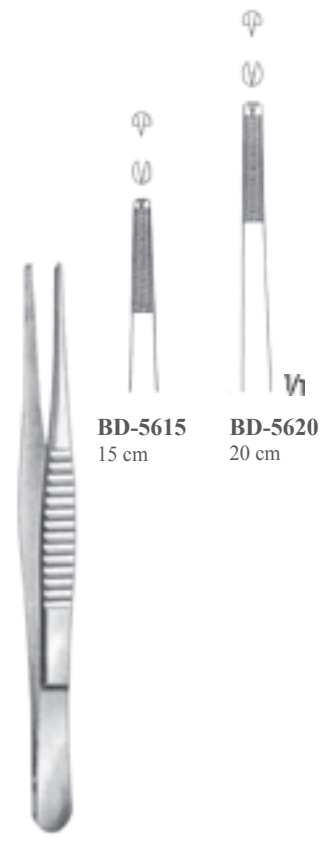

STRASSBURGER MODEL
BD-5615 - BD-5620
Doku pensetleri
Tissue forceps

BD-5615
15 cm

BD-5620
20 cm

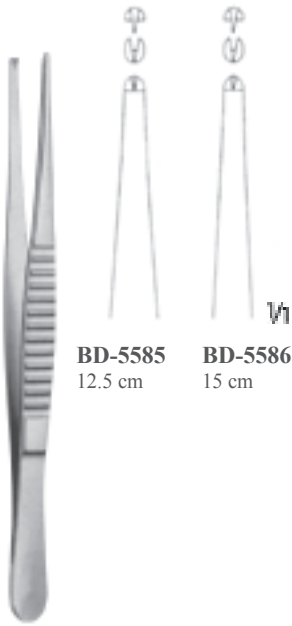

BD-5585 12.5 cm
BD-5586 15 cm

TREVES
BD-5585 - BD-5586
Doku pensetleri
Tissue forceps

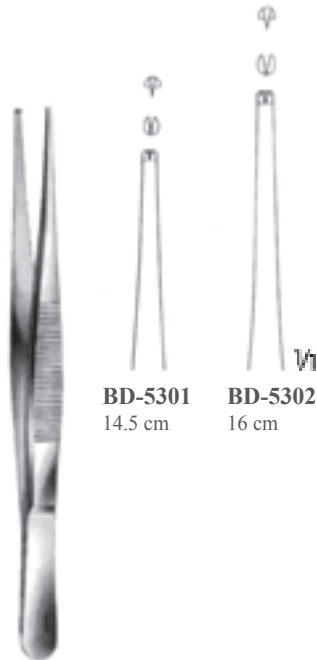

BD-5301 14.5 cm
BD-5302 16 cm

BD-5301 - BD-5302
Doku pensetleri
Tissue forceps

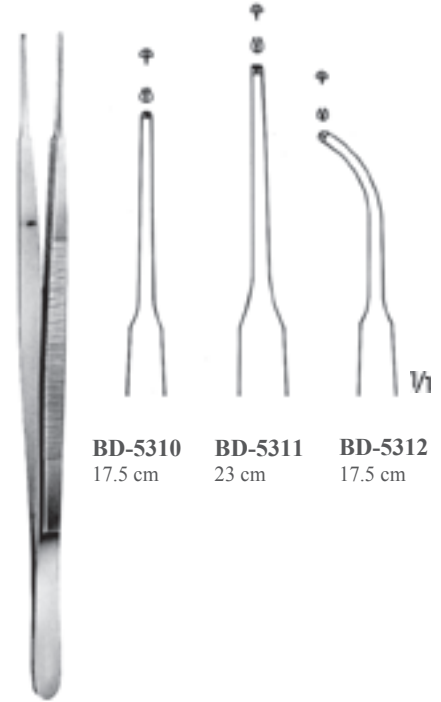

BD-5310 17.5 cm
BD-5311 23 cm
BD-5312 17.5 cm

GERALD
BD-5310 - BD-5312
Hassas doku pensetleri
Delicate tissue forceps

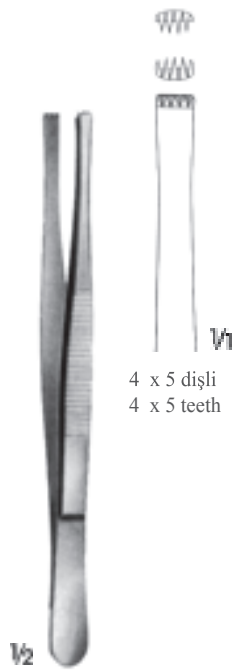

BD-5554
14.5 cm



BD-5503
Güçlü model/Heavy Pattern
14.5 cm



MC INDOE
BD-5565
15 cm



GILLIES
BD-5570
15.5 cm

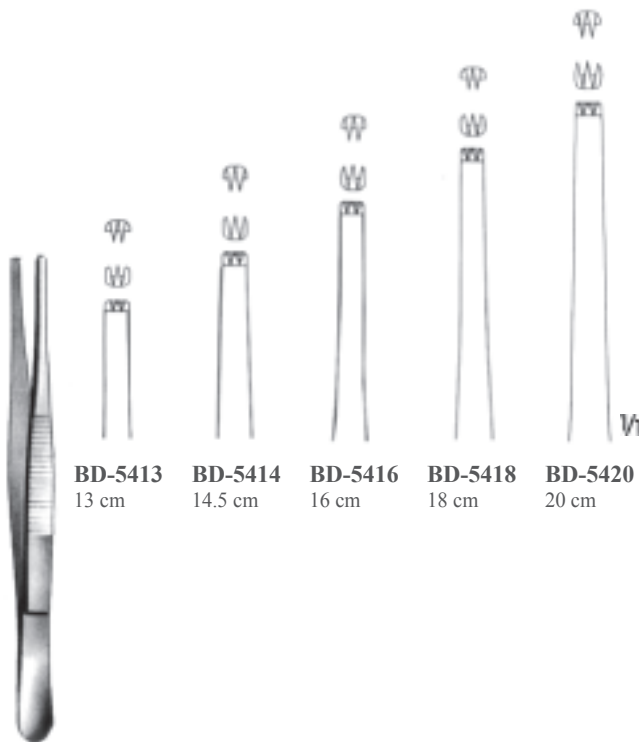

BD-5413 - BD-5420
2 x 3 diş/2 x 3 teeth

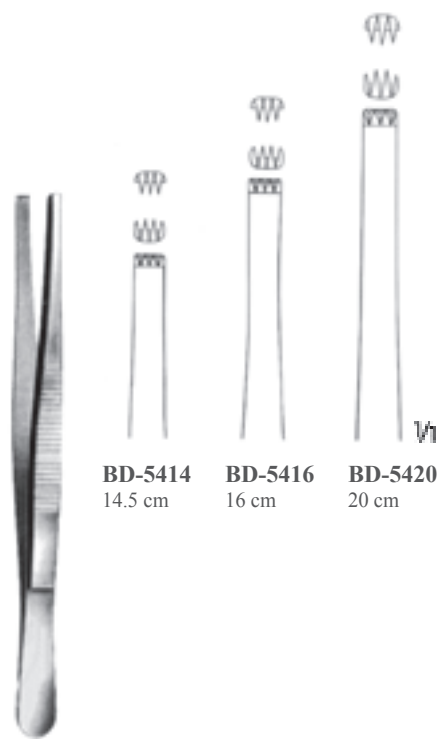

BD-5414 - BD-5420
3 x 4 diş/3 x 4 teeth



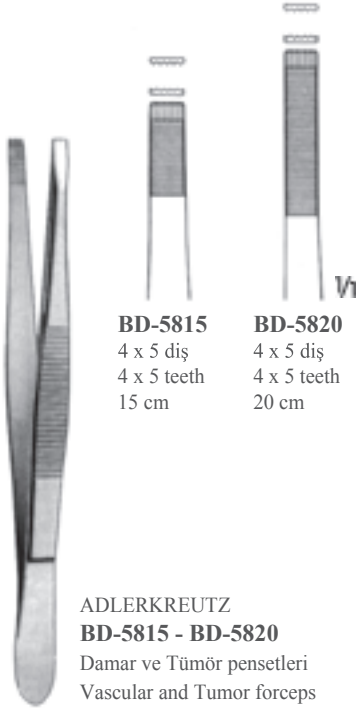

BD-5815
4 x 5 diş
4 x 5 teeth
15 cm

BD-5820
4 x 5 diş
4 x 5 teeth
20 cm

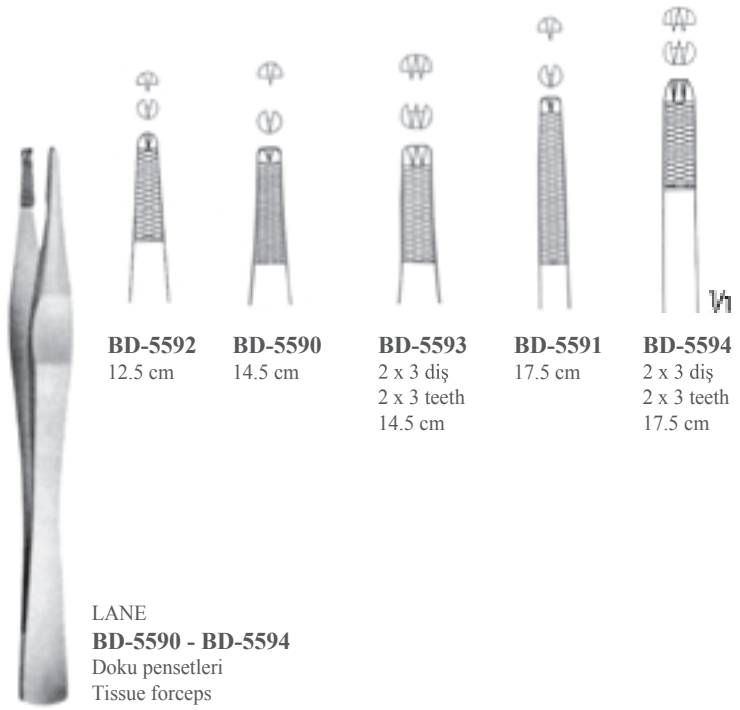

BD-5592
12.5 cm

BD-5590
14.5 cm

BD-5593
2 x 3 diş
2 x 3 teeth
14.5 cm

BD-5591
17.5 cm

BD-5594
2 x 3 diş
2 x 3 teeth
17.5 cm

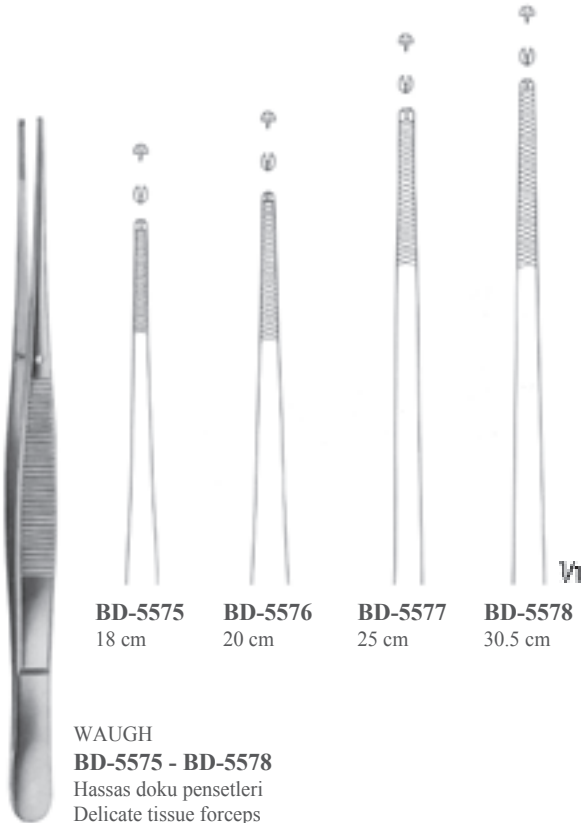

BD-5575
18 cm

BD-5576
20 cm

BD-5577
25 cm

BD-5578
30.5 cm

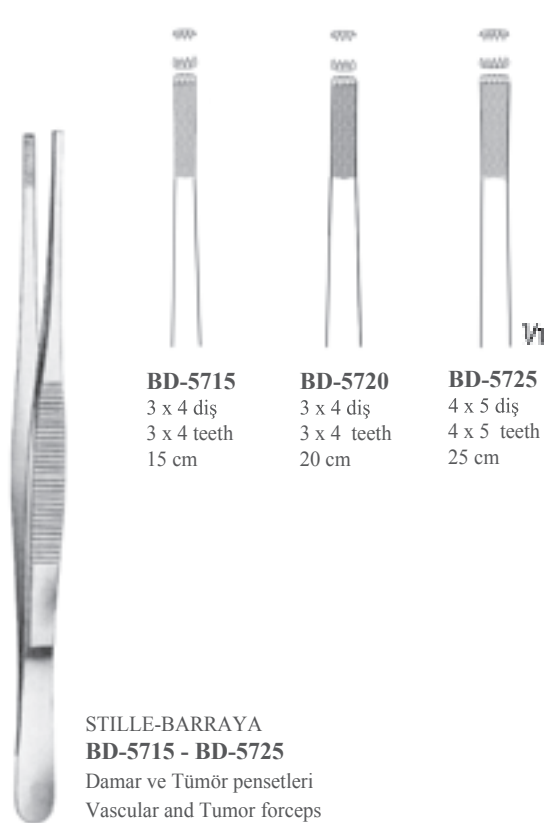

BD-5715
3 x 4 diş
3 x 4 teeth
15 cm

BD-5720
3 x 4 diş
3 x 4 teeth
20 cm

BD-5725
4 x 5 diş
4 x 5 teeth
25 cm

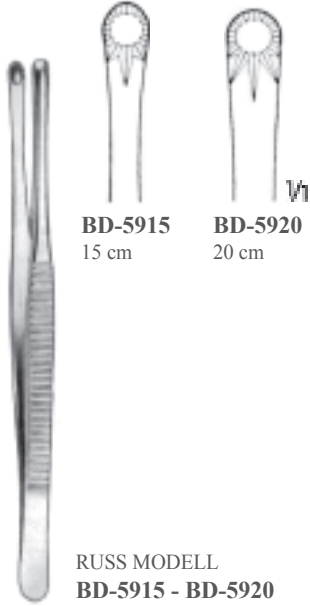

HARDMODEL 

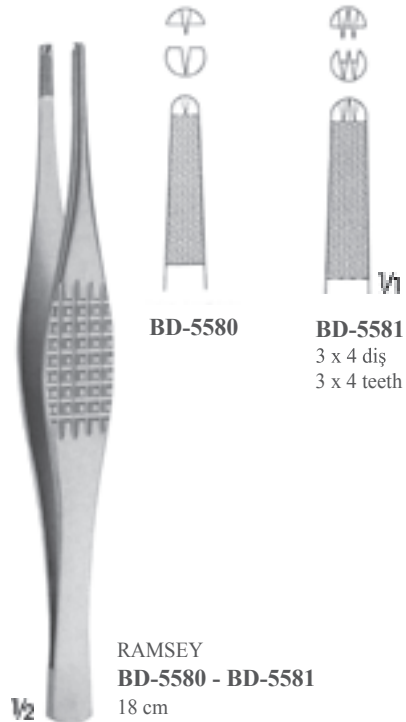
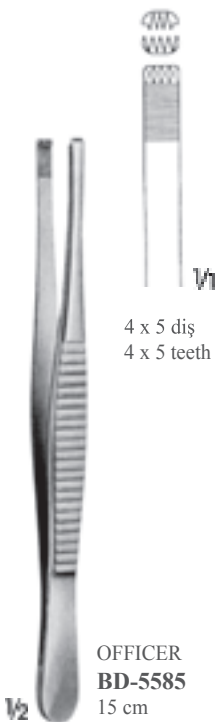



**DUVAL
BD-6100**
Bağırsak penseti
Intestinal forceps
14 cm



**DENNIS-BROWNE
BD-6101**
Bağırsak pensetleri
Intestinal forceps
19 cm



**NELSON
BD-6103**
Akciğer tutucu penseti
Lung Grasping forceps
23 cm

6 x 7 diş
6 x 7 teeth

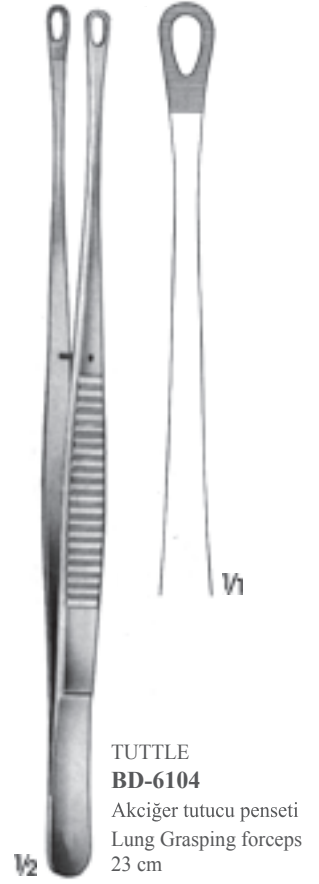

**TUTTLE
BD-6104**
Akciğer tutucu penseti
Lung Grasping forceps
23 cm



**BONNEY
BD-4750**
Doku penseti
Tissue forceps
17.5 cm



**CHARNLEY
BD-5560**
Doku penseti
Tissue forceps
18 cm



**JACKSON-BURROWS
BD-5550**
Doku penseti
Tissue forceps
14 cm

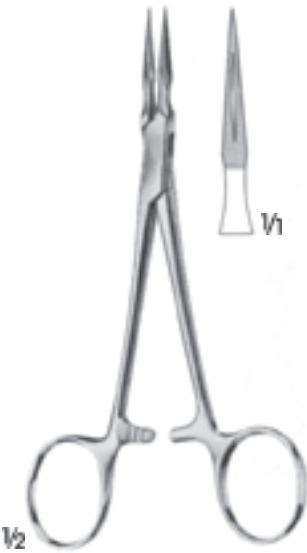

**STIEGLITZ
BD-6110**
Kıymık penset
Splinter forceps
14 cm



**STIEGLITZ
BD-6111**
Kıymık penset
Splinter forceps
14 cm

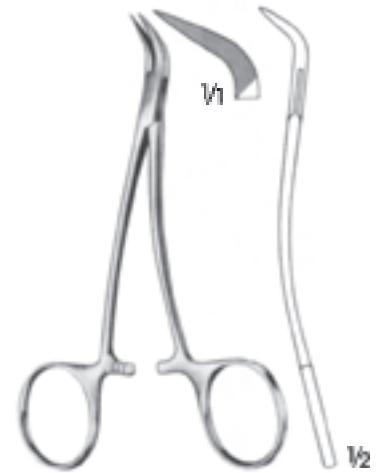

**STIEGLITZ
BD-6112**
Kıymık penset
Splinter forceps
12 cm



BD-6105
Kıymık penset
Splinter forceps
8 cm

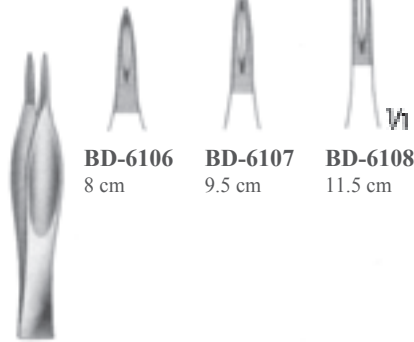

**FEILCHENFELD
BD-6106 - BD-6108**
Kıymık pensetler
Splinter forceps

BD-6106
8 cm

BD-6107
9.5 cm

BD-6108
11.5 cm



**HUNTER
BD-6109**
Kıymık penset
Splinter forceps
10.5 cm



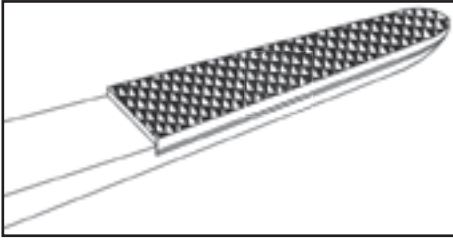

Karbid uçlu Diseksiyon Pensetleri

- İnce yapılı karbid ucu sayesinde verimli kullanım
- Sıkı şekilde ve dokuya zarar vermeden kavrama
- Çok amaçlı kullanım
- Uzun çalışma süresi

Carbide-tipped dissecting forceps

- Due-to slender carbide tip, efficient use
- Tight gripping without damaging the tissue
- Multi-purpose use
- Long working life

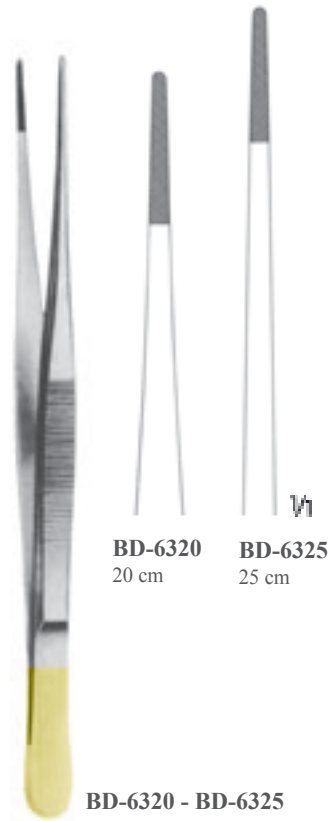
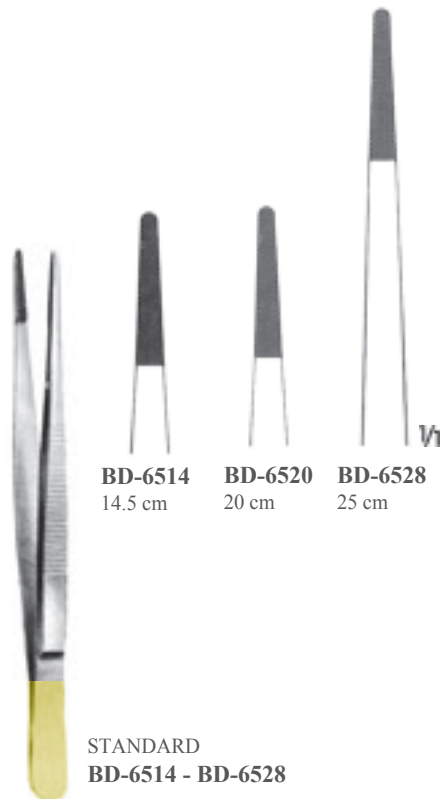
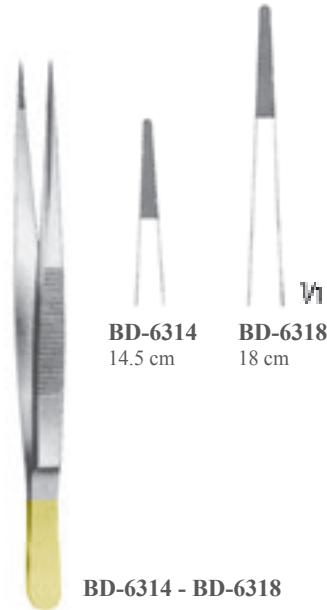

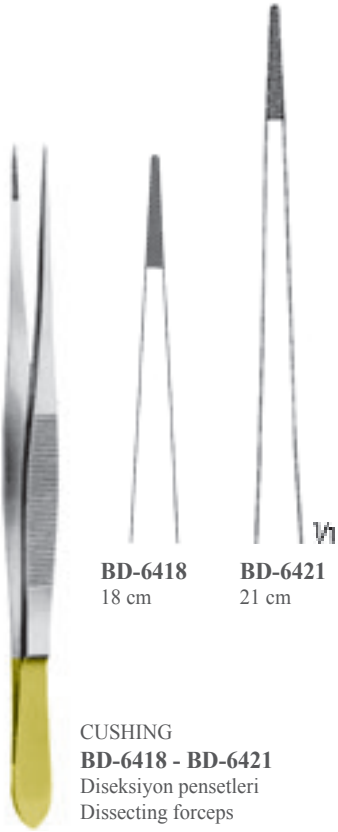

CUSHING
BD-6418 - BD-6421
Diseksiyon pensetleri
Dissecting forceps



GRUENWALD
BD-6614 - BD-6616
Diseksiyon pensetleri
Dissecting forceps



GRUENWALD
BD-6618
Diseksiyon penseti
Dissecting forceps
18.5 cm

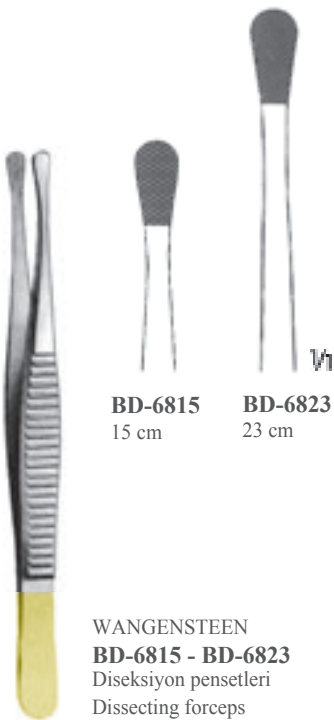

WANGENSTEEN
BD-6815 - BD-6823
Diseksiyon pensetleri
Dissecting forceps



FERRIS-SMITH
BD-6850
Diseksiyon penseti
Dissecting forceps
17.5 cm



Yastık şekilli ucu ile güvenli nazik bir kavrama sağlar
Cushion shaped tip ensures a safe and gentle grasping of the thread

BD-6700
Sutür penseti/Suture forceps
20 cm



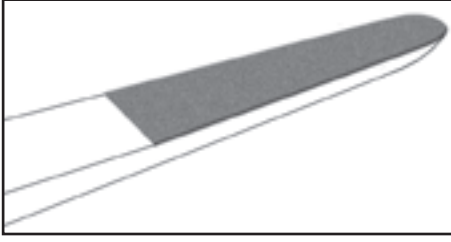

DIAPOWDER ağızlar, daha sert ve aşınmaya dayankılı yüzeyler sağlar.
DIAPOWDER ağızlar, hassas iğne, sütur ve dokuların güvenilir bir şekilde kavranmasını garanti eder.

DIAPOWDER jaws provide harder and more wear resistant surfaces.
DIAPOWDER jaws ensure reliable grip of fine needles, sutures and tissues.



	Ø 1.0 mm	Ø 1.0 mm	Ø 1.0 mm		Ø 1.0 mm	Ø 2.0 mm	Ø 1.0 mm
18.5 cm 21 cm	BD-8118 BD-8121 Platform tip, düz Platform tip, straight	BD-8218 BD-8221 Düz/Straight	BD-8318 BD-8321 Eğri/Curved	15 cm 18.5 cm 21 cm 23 cm 25 cm	BD-8415 BD-8418 BD-8421 BD-8423 BD-8425 Düz/Straight	- BD-8430 - - -	BD-8515 BD-8518 BD-8521 BD-8523 BD-8525 Eğri/Curved
BD-8118 - BD-8321				BD-8415 - BD-8525			
	Ø 2.5 mm	Ø 2.5 mm			Ø 1.2 mm		
18 cm 20 cm	BD-8918 18 cm	BD-8920 20 cm		18 cm	BD-8818 18 cm		BD-8822 22 cm
BD-8918 - BD-8920							

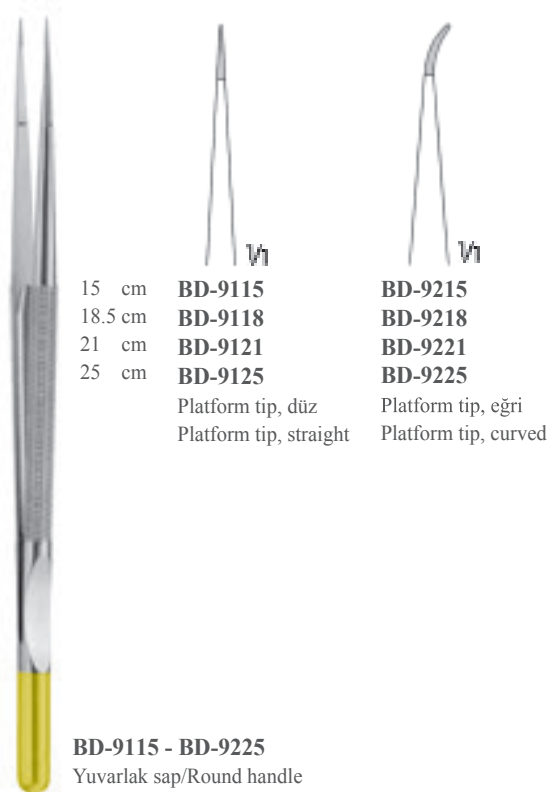
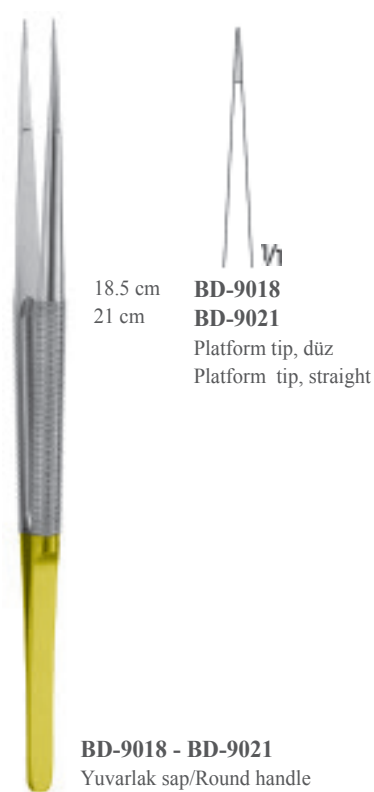
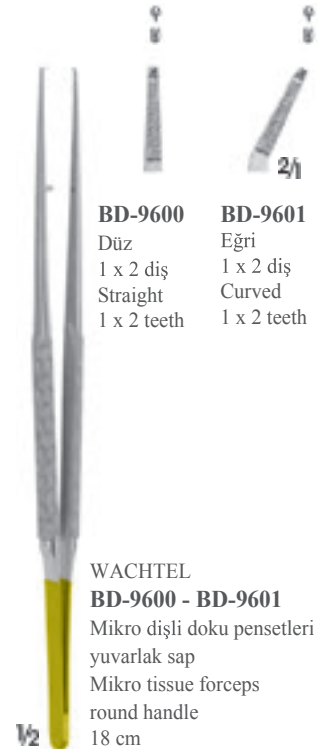
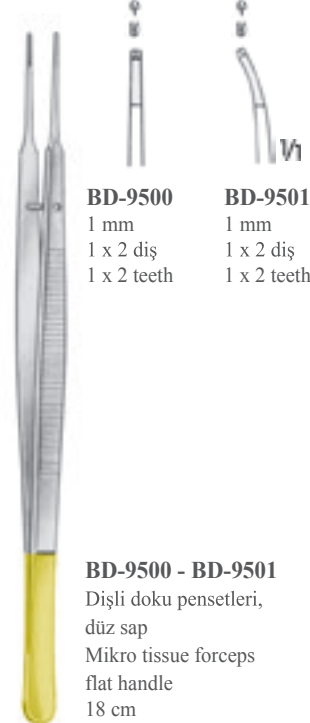
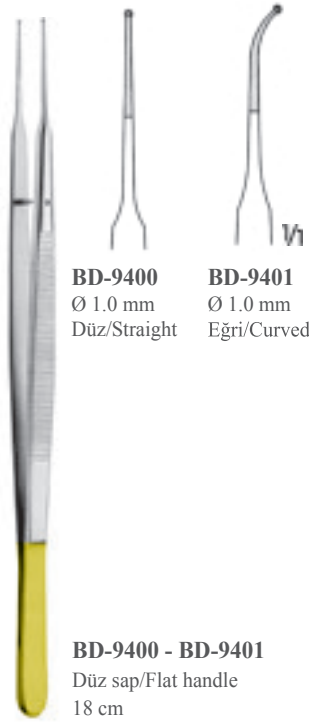



DIAPOWDER



BD-8618 18.5 cm
BD-8621 21 cm
BD-8623 23 cm
Platformlu tip, düz
Platform tip, straight

DIAPOWDER



BD-8718 18.5 cm
BD-8721 21 cm
BD-8723 23 cm
Düz, straight

De Bakey Diş



Toothing De Bakey

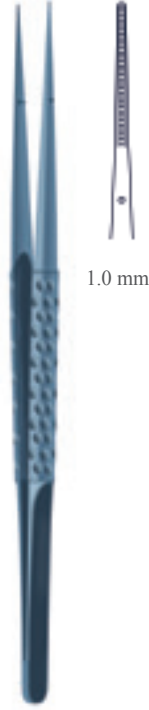

BD-2818 18.5 cm
BD-2821 21 cm
BD-2823 23 cm
Düz, straight

0.2 mm

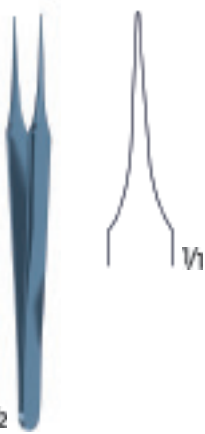

BD-1104
Mikro penset, kuyumcu tipi
Micro forceps, jeweler patterns
11 cm

0.3 mm



BD-1107
Mikro penset, kuyumcu tipi
Micro forceps, jeweler patterns
11 cm

Platform tip
Platform tip

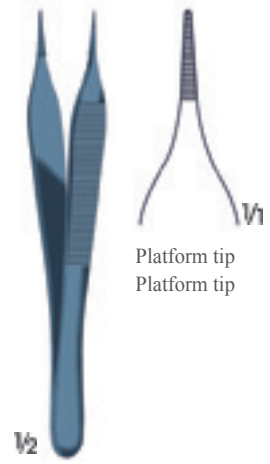

MICRO-ADSON
BD-1501
Hassas diseksiyon penset
Delicate dissecting forceps
12 cm



BD-5113
13 cm



BD-5114
14.5 cm



BD-5116
16 cm



BD-5118
18 cm



BD-5120
20 cm



BD-5113 - BD-5120

Dişli doku pensetler, standart model
Tissue forceps, standard patterns



V2



V1

MICRO - ADSON
BD-4835

Hassas dişli doku penset
Delicate tissue forceps
12 cm



V2



V1

ADSON
BD-4851

Hassas dişli doku penset
Delicate tissue forceps
12 cm



V2



V1

Platformlu
With plateau

ADSON
BD-4856

Hassas dişli doku penset
Delicate tissue forceps
12 cm





CUSHING
BD-1901 - BD-1903
Hassas diseksiyon pensetler
Delicate dissecting forceps

BD-1901
18 cm

BD-1903
20 cm



BD-1921 - BD-1923
Hassas diseksiyon pensetler
Delicate dissecting forceps
20 cm

BD-1921

BD-1923



BD-2015 - BD-2017
Diseksiyon pensetler, orta
Dissecting forceps, medium

BD-2015
14.5 cm

BD-2017
16 cm



BD-2411 - BD-2420
Diseksiyon pensetler, standart model
Dissecting forceps, standard patterns

BD-2411
11.5 cm

BD-2413
13 cm

BD-2414
14.5 cm

BD-2416
16 cm

BD-2420
20 cm

De Bakey Diş



Toothing De Bakey

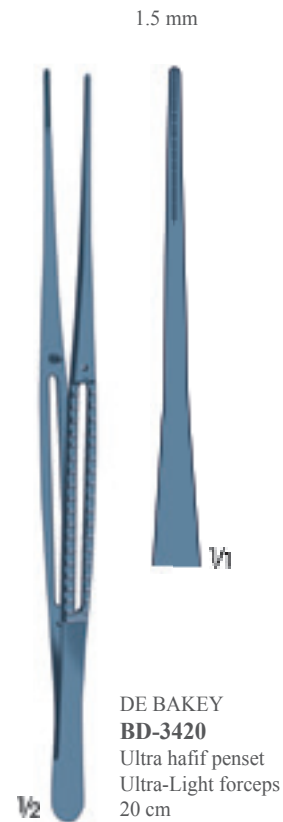
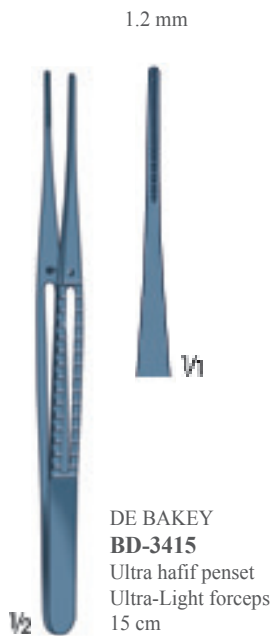
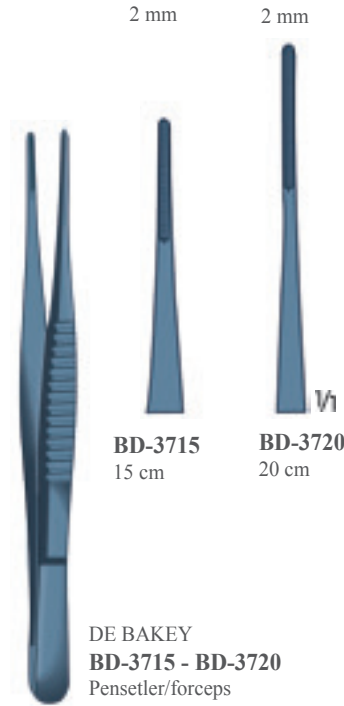
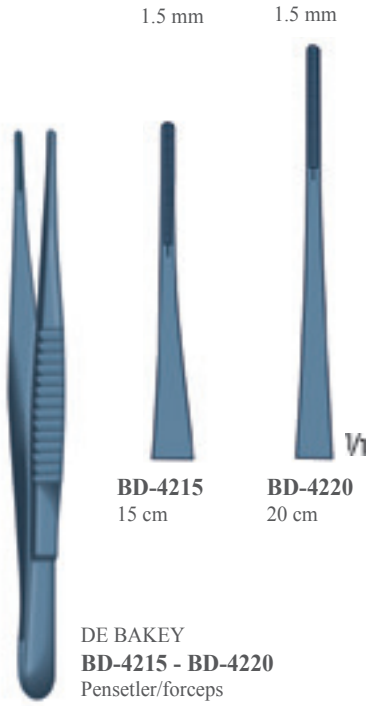

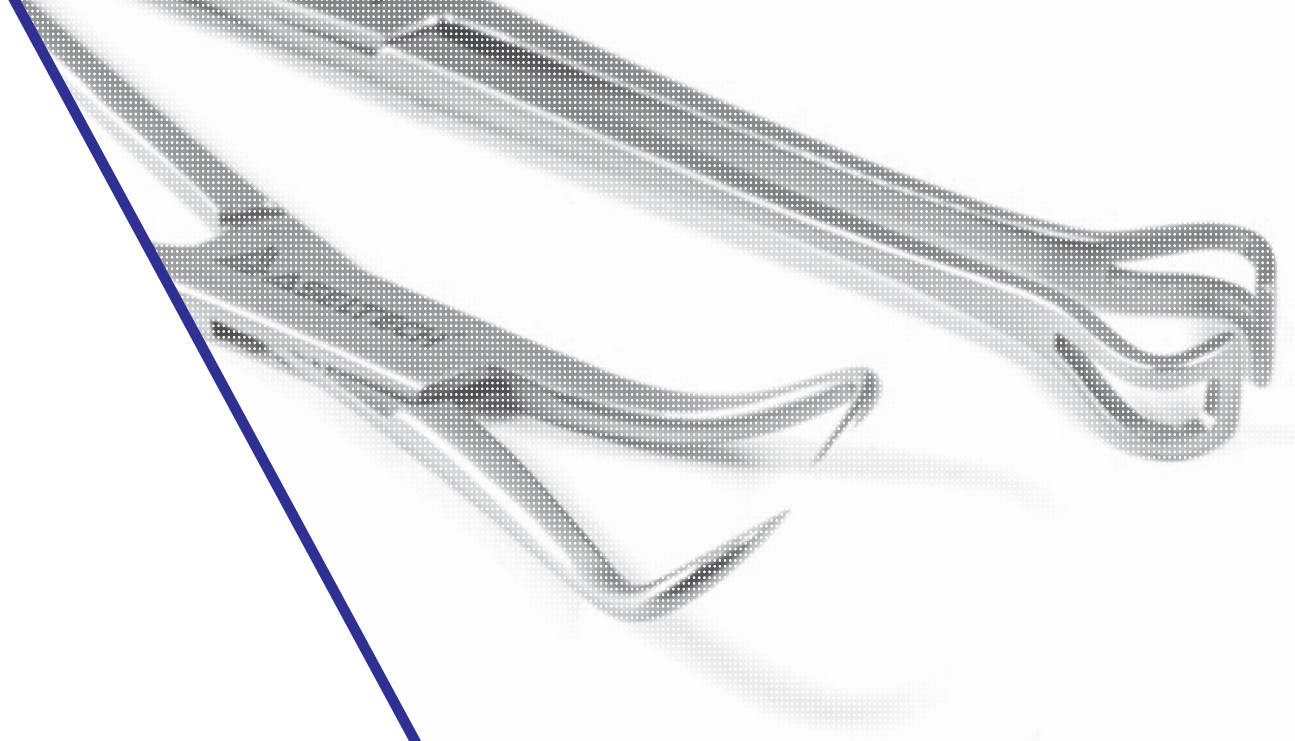

BE

Spanç, Doku ve Çamaşır Pensleri
Sponge, Tissue and Washing Forceps





V2

BE-1214
Kilitsiz/Without ratchet
14.5 cm



V2

BE-1314
Kilitli/With ratchet
14.5 cm



V2

GROSS
BE-1618 - BE-1718
Kilitli/With ratchet
18 cm

BE-1618

BE-1718



V2

BRYANT
BE-1100
13 cm



V2

LISTER
BE-1113 - BE-1117
Burun pensleri/Sinus forceps

BE-1113
13 cm

BE-1116
16 cm

BE-1117
17.5 cm



V2

BE-1800
17.5 cm

V1





DUPLAY
BE-1905
21 cm



DUPLAY
BE-1910
19 cm

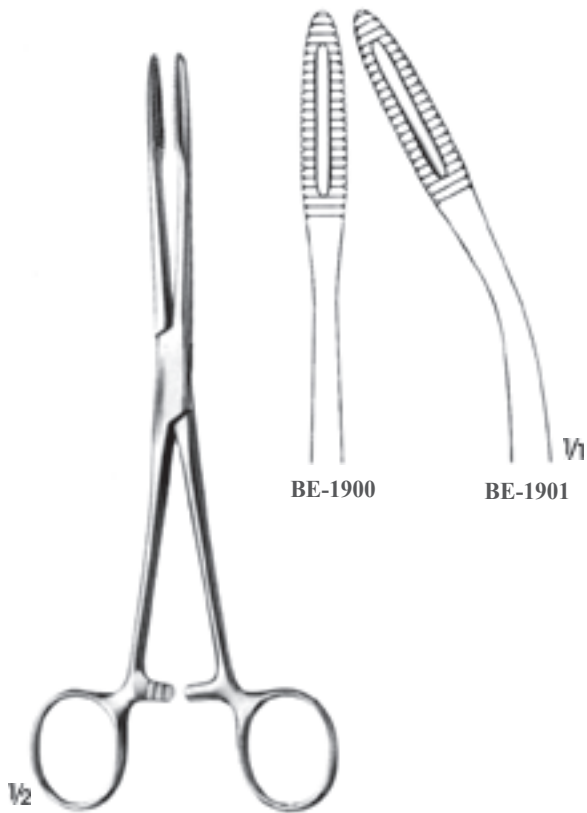

GROSS
BE-1900 - BE-1901
20 cm

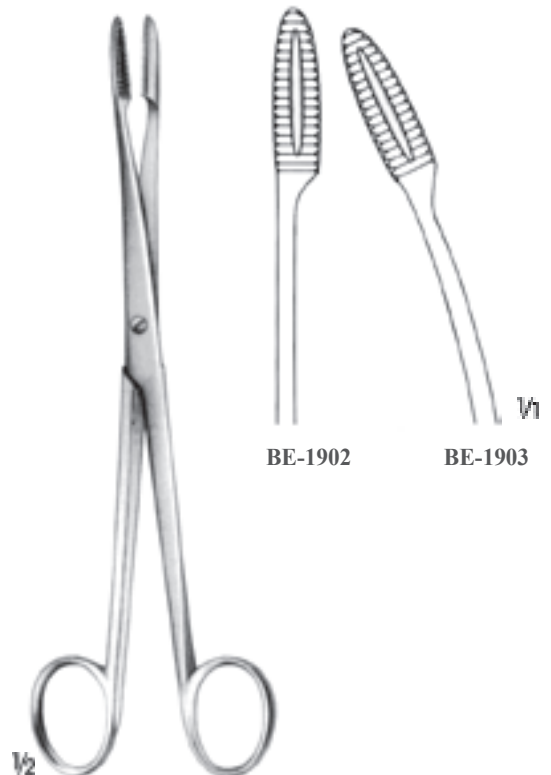

GROSS
BE-1902 - BE-1903
Kilitsiz/Without ratchet
20 cm



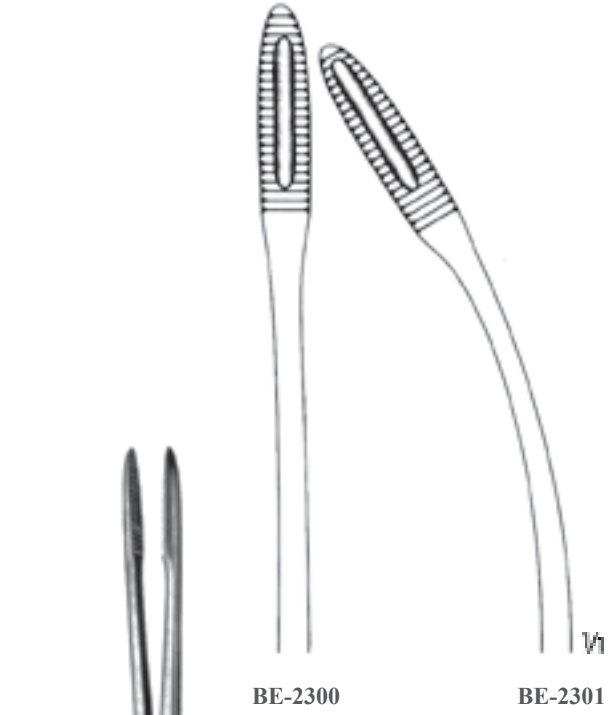

BE-2300

BE-2301

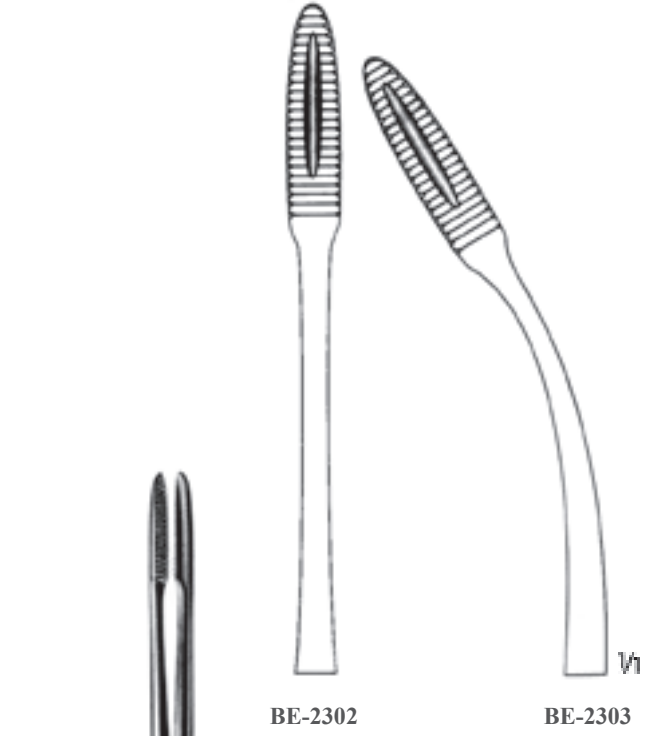

BE-2302

BE-2303



1/2

MAIER
BE-2300 - BE-2301
Kilitsiz/Without ratchet
26.5 cm



1/2

MAIER
BE-2302 - BE-2303
Kilitli/With ratchet
26.5 cm







ULRICH
BE-2200 - BE-2202

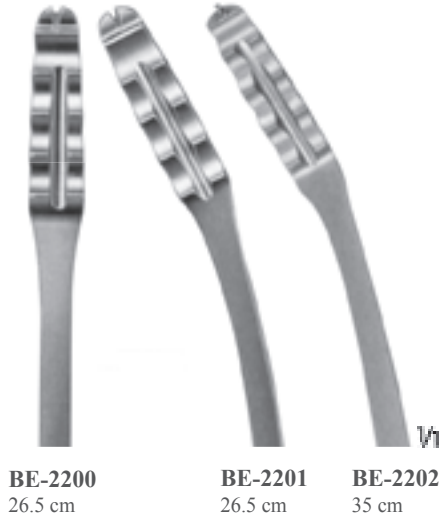

BE-2200
26.5 cm

BE-2201
26.5 cm

BE-2202
35 cm



BE-2100

BE-2101

BE-2100 - BE-2101
22 cm



COLLIN
BE-2340
24 cm



CHERON
BE-2345
Açılı saplar
Handles angled to side
24 cm



EMMET
BE-2335
21 cm



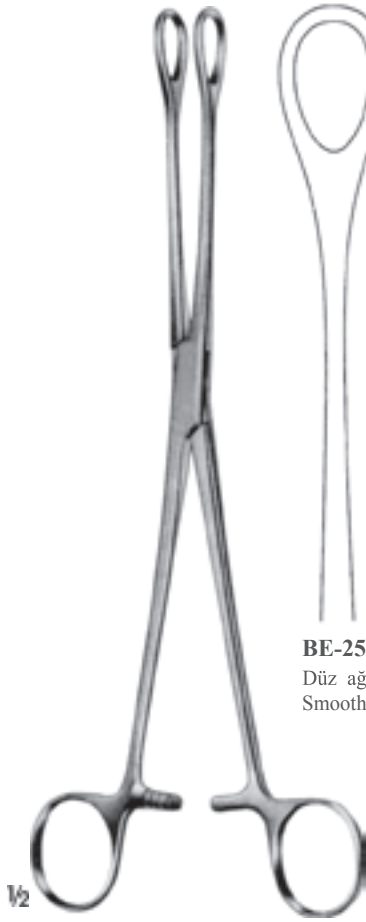

BE-2500
Düz ağız
Smooth jaws

FOERSTER-BALLENGER
BE-2500 - BE-2501
24.5 cm



BE-2501
Düz ağız
Smooth jaws



BE-2600

FOERSTER-BALLENGER
BE-2600 - BE-2601
24.5 cm

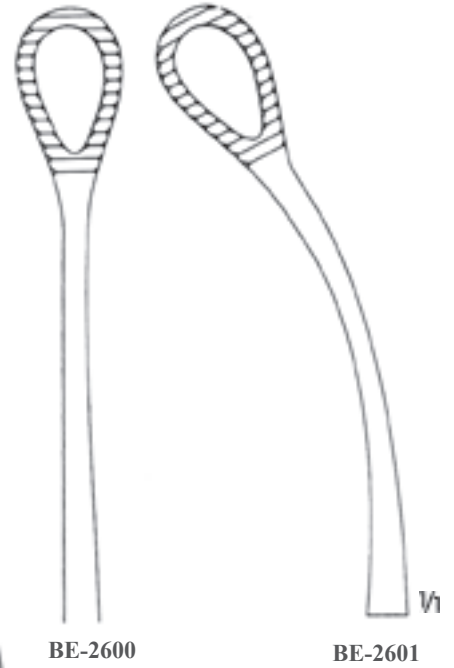

BE-2601



BE-2350
18 cm

RAMPLEY
BE-2350 - BE-2351



BE-2351
25 cm



BE-2400

FOERSTER-BALLENGER
BE-2400 - BE-2401
18 cm

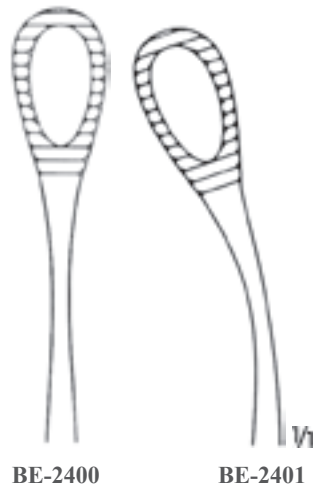

BE-2401



BE-3010
16 cm

BE-3012
16 cm

BE-3011
17 cm

COLLIN
BE-3010 - BE-3012



WILLIAMS
BE-2845
Organ pensi
Organ forceps
16 cm



HEYWOOD-SMITH
BE-2620
21.5 cm



HEYWOOD-SMITH
BE-2911
20 cm



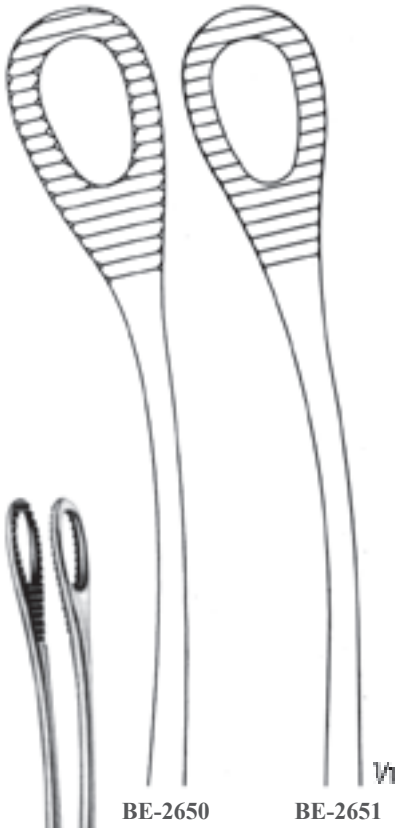

BE-2650

BE-2651



V₂

KELLY
BE-2650 - BE-2651
32 cm



V₁

V₁



V₂

HEYWOOD-SMITH
BE-3020
25 cm

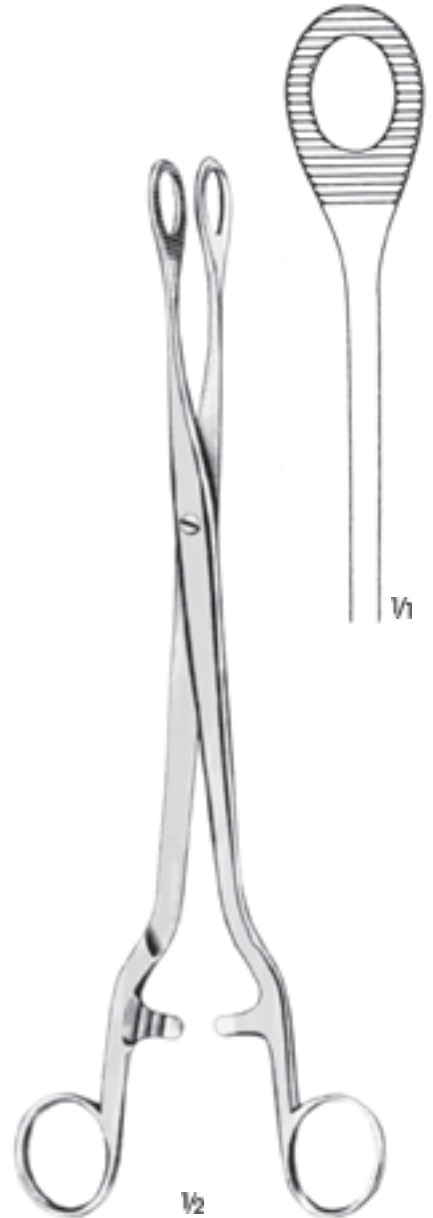

V₂

NOTO
BE-2640
28 cm

De Bakey Diş



Toothing De Bakey

21 mm



BE-2660

27 mm



BE-2661



2/3 sıra diş
2/3 teeth rows

21 mm



BE-2907

23 mm



BE-2908



BE-2660 25 cm
BE-2661 27 cm



COLLIN
BE-2907 19.5 cm
BE-2908 23 cm





BE-3300
Tendon geçmeli pens
Tendon seizing forceps
12 cm

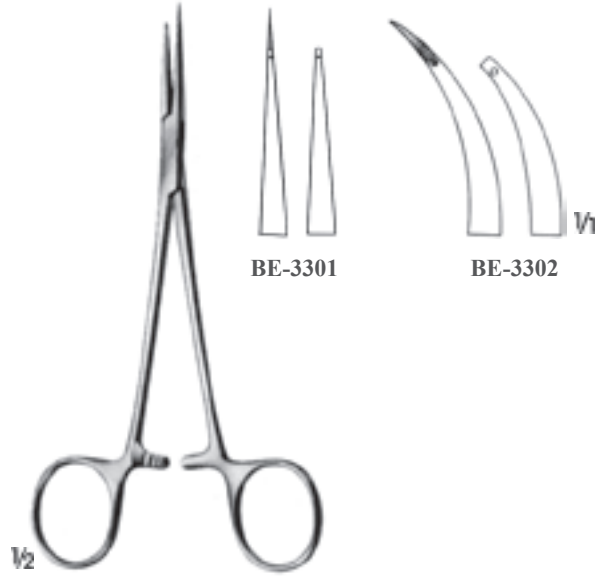

BE-3301 - BE-3302
Tendon geçmeli pensleri
Tendon interlacing forceps
15 cm



JACKSON
BE-3208
Tendon tutucu pens
Tendon seizing forceps
4x5 diş/4x5 teeth
15 cm



HERZ
BE-3209
Tendon tutucu pens (İnce tırtıllı)
Tendon seizing forceps (Fine serrated)
15.5 cm

BE-3210
Tendon tutucu pens (Kalın tırtıllı)
Tendon seizing forceps (Thick serrated)
15.5 cm





BE-3500
Düz/Straight
18.5 cm



BE-3501
Eğri/Curved
18.5 cm



BE-3502
Düz/Straight
15 cm



BE-3503
Eğri/Curved
15 cm

BRAND
BE-3500 - BE-3503
Tendon tutma pensleri
Tendon holding forceps



KLEINERT-KUTZ
BE-3520
Tendon geçiş pens
Tendon passing forceps
20.5 cm

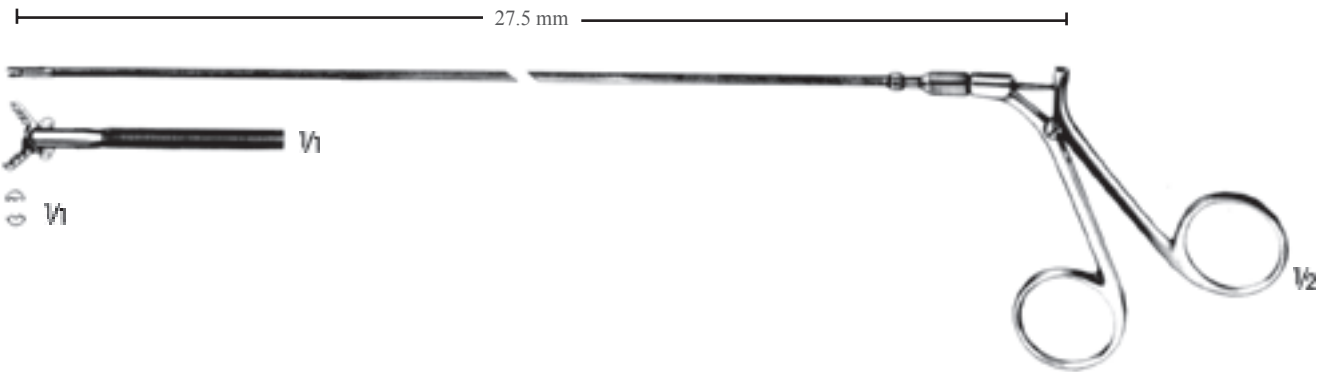

JAGER
BE-3405
Tendon ve çapraz bağlara geçiş
sağlayan pens, esnek shaft
Tendon-and cross ligament passing
forceps flexible shaft
27.5 cm





BABY-ALLIS
BE-2700
4 x 5 diş/4 x 5 teeth
13 cm



BOYS-ALLIS
BE-2701
5 x 6 diş/5 x 6 teeth
15.5 cm

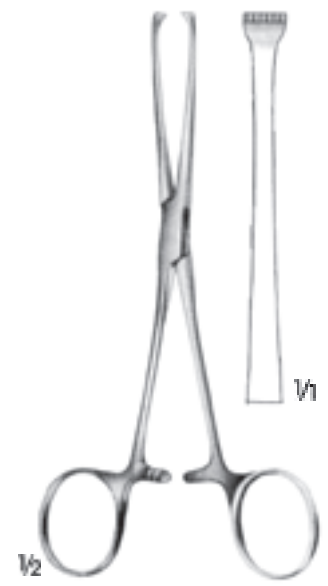

ALLIS
BE-2705
5 x 6 diş/5 x 6 teeth
15.5 cm



POIRIER
BE-2740
2 x 3 diş
2 x 3 teeth
12.5 cm



CHAPUT
BE-2670
2 x 3 diş, sivri
2 x 3 teeth, sharp
12.5 cm



TUFFIER
BE-2675
5 x 6 diş, sivri
5 x 6 teeth, sharp
12.5 cm

Atromatik
Atraumatic



ALLIS
BE-2750 - BE-2756

6.2 mm



BE-2750
15.5 cm

7.0 mm



BE-2751
20 cm

8.4 mm



BE-2752
22 cm

8.4 mm



BE-2753
25.5 cm

8.4 mm



BE-2754
30 cm

8.4 mm



BE-2756
35 cm

5.0 mm



BE-2755
29.5 cm



ALLIS
BE-2710 - BE-2720
15.5 cm

BE-2715
2 x 3 diş
2 x 3 teeth

BE-2720
3 x 4 diş
3 x 4 teeth

BE-2710
4 x 5 diş
4 x 5 teeth



JUDD-ALLIS
BE-2725
3 x 4 diş
3 x 4 teeth
15.5 cm



ALLIS-ADAIR
BE-2745
9 x 10 diş
9 x 10 teeth
16 cm





BE-2730
19 cm

BE-2735
25.5 cm

ALLIS
BE-2730 - BE-2735
5 x 6 diş
5 x 6 teeth

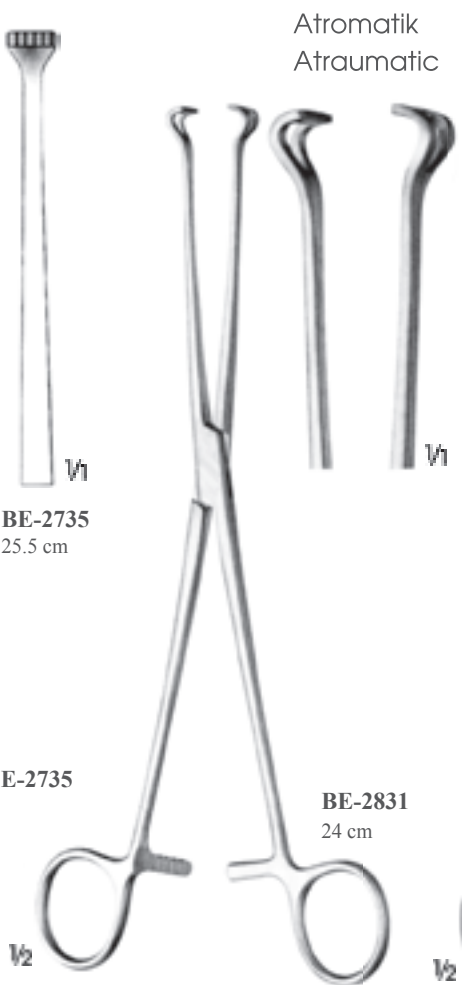

Atromatik
Atraumatic

BE-2831
24 cm

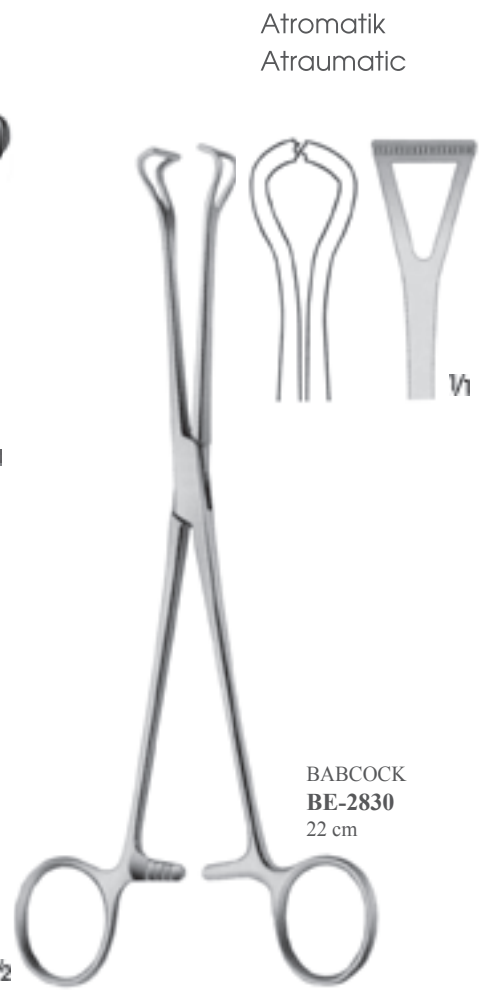

Atromatik
Atraumatic

BABCOCK
BE-2830
22 cm

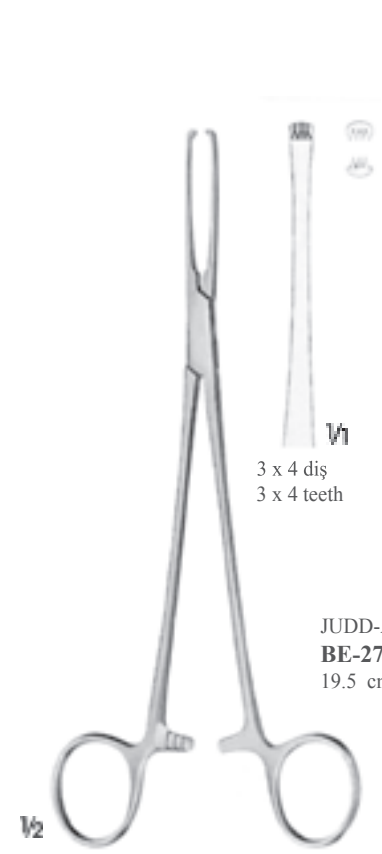

3 x 4 diş
3 x 4 teeth

JUDD-ALLIS
BE-2765
19.5 cm

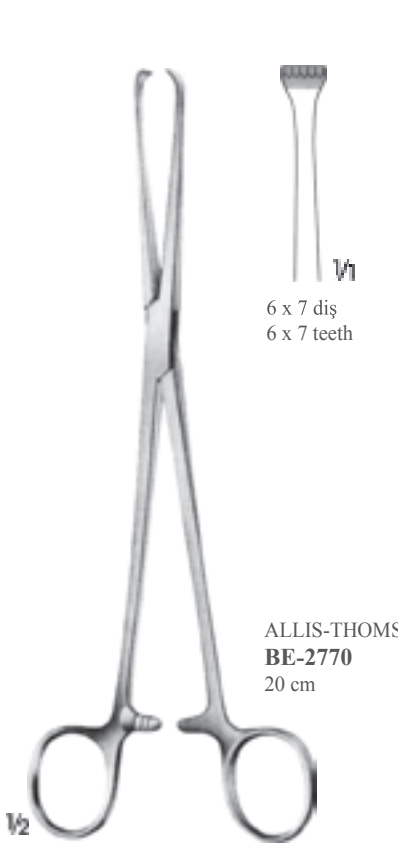

6 x 7 diş
6 x 7 teeth

ALLIS-THOMS
BE-2770
20 cm

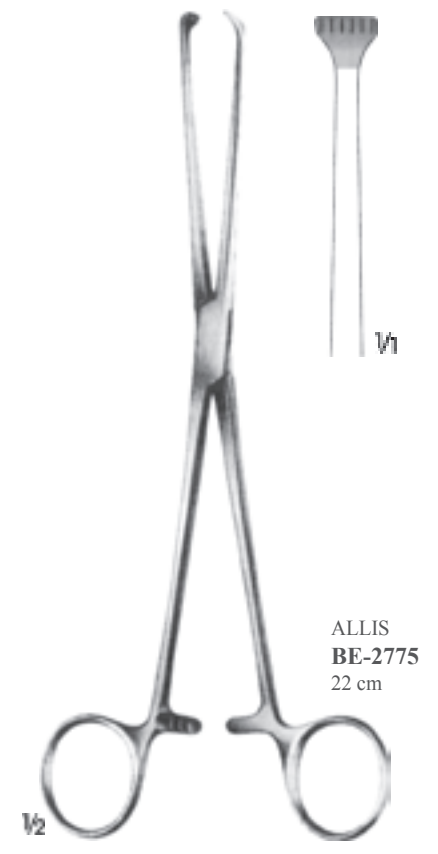

ALLIS
BE-2775
22 cm

Atromatik
Atraumatic



BE-2832
16 cm

BE-2833
21.5 cm

BABCOCK
BE-2832 - BE-2833

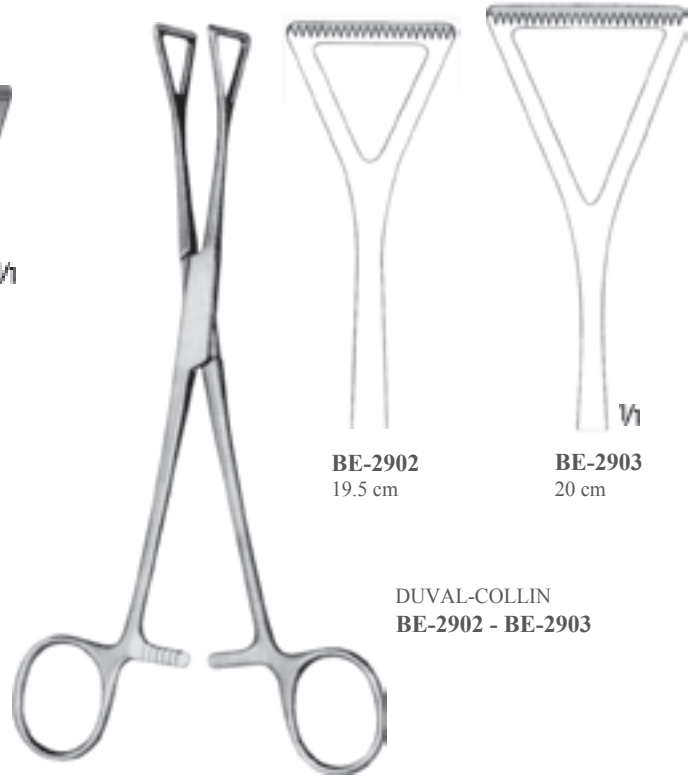

BE-2902
19.5 cm

BE-2903
20 cm

DUVAL-COLLIN
BE-2902 - BE-2903



BABCOCK
BE-2800
15.5 cm

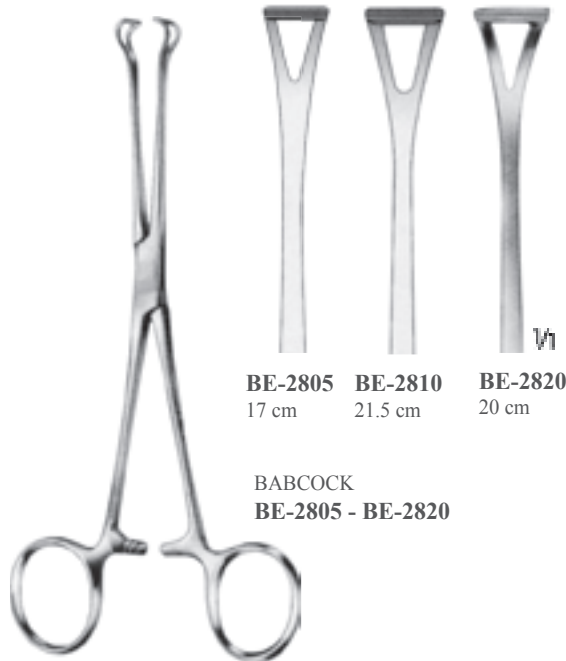

BE-2805
17 cm

BE-2810
21.5 cm

BE-2820
20 cm

BABCOCK
BE-2805 - BE-2820

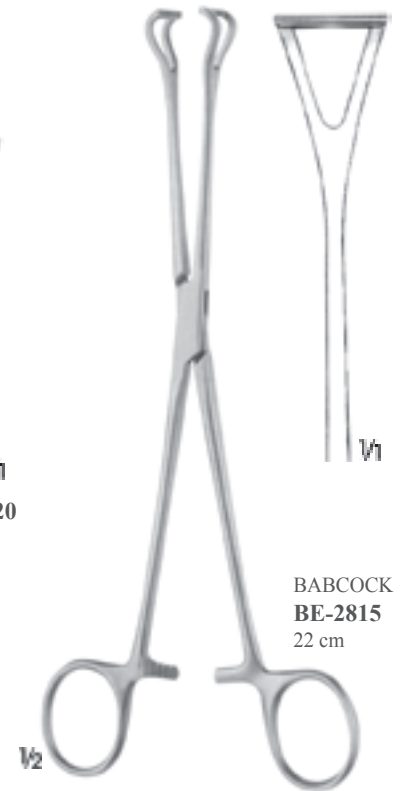

BABCOCK
BE-2815
22 cm



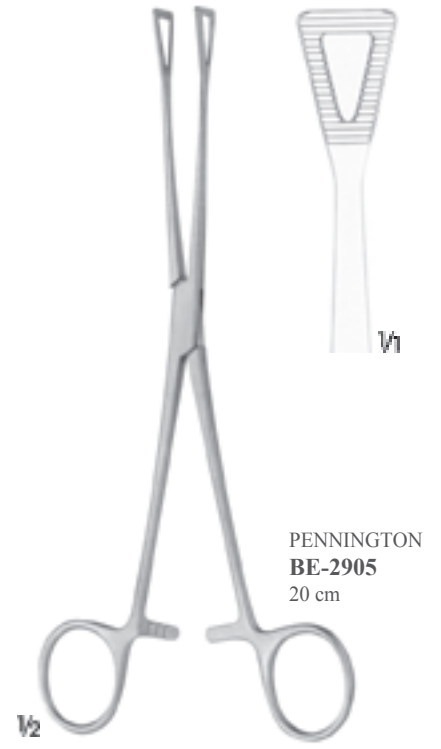
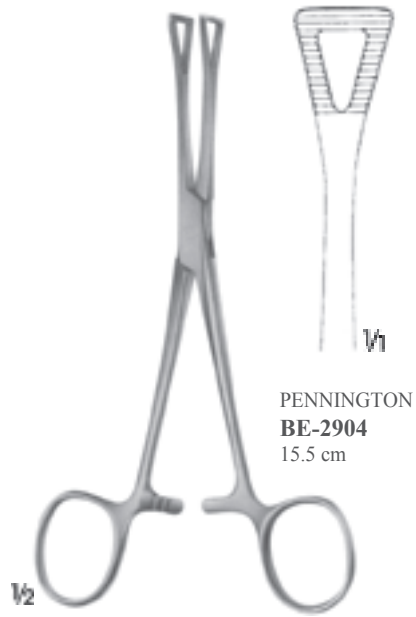
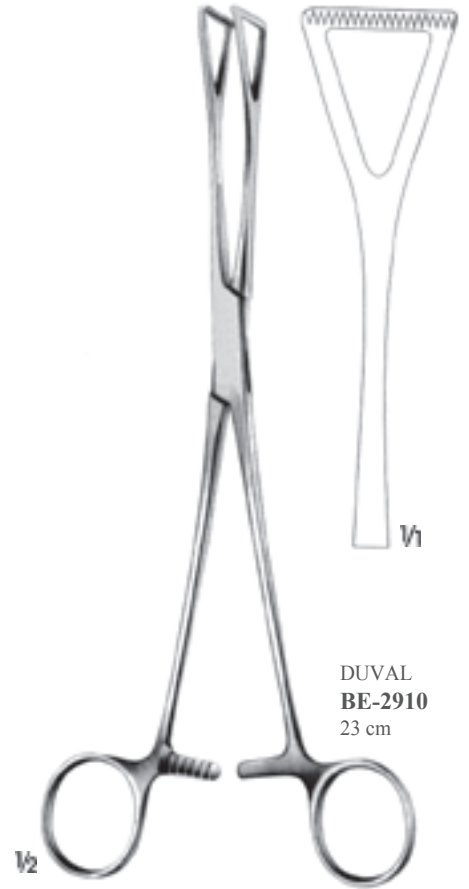
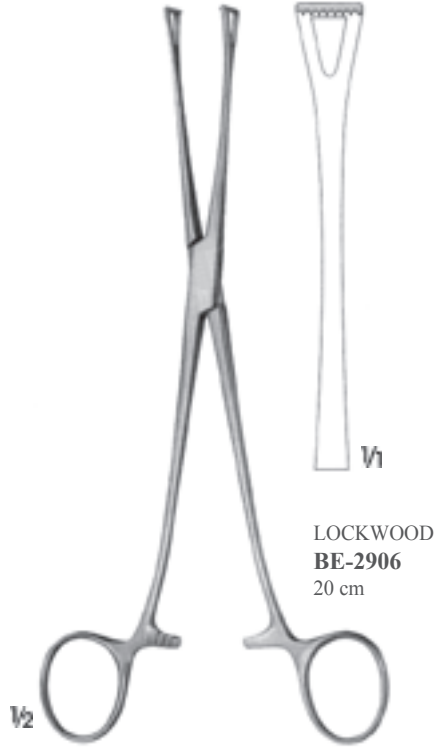

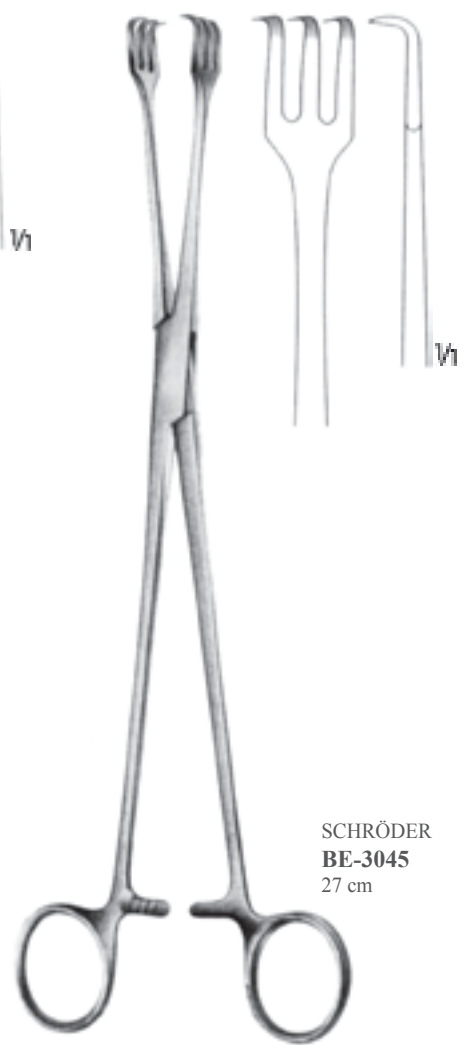
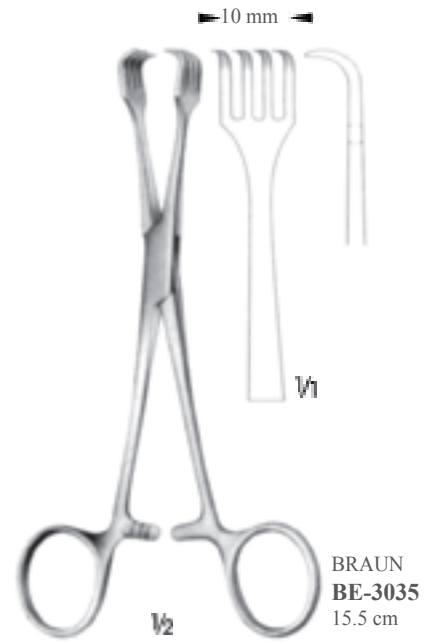
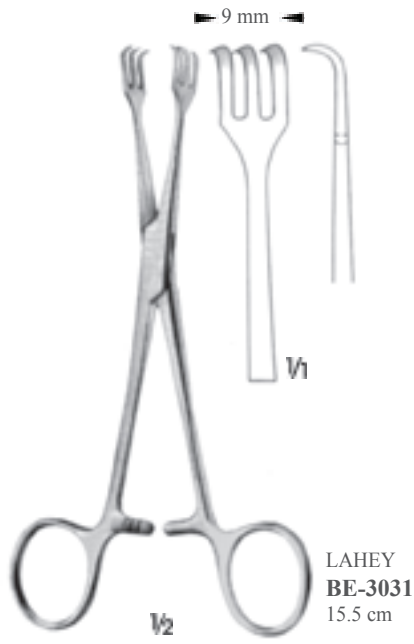

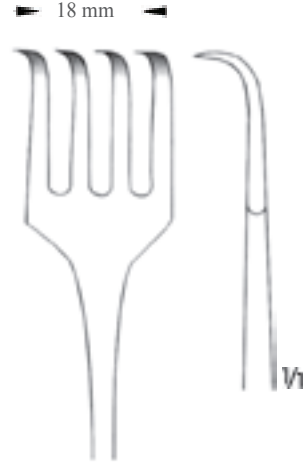
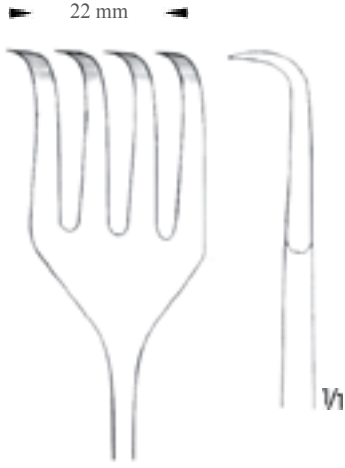

PRATT
BE-3051
27 cm



BE-3050
26 cm



WILSON
BE-3101
24 cm



SCHRÖDER
BE-3100
25 cm



POZZI
BE-3103
25.5 cm





BE-3600

BE-3601

PELKMANN
BE-3600 - BE-3601
26 cm

BE-3530
21 cm

PITHA
BE-3535
22 cm



DOYEN
BE-3715
11 cm



DOYEN
BE-3720
18 cm



LANE
BE-3813 - BE-3819



BE-3813
13 cm



BE-3815
15.5 cm



BE-3819
19.5 cm



BE-3700
5.5 cm



ENGL.MOD
BE-3701
8.5 cm

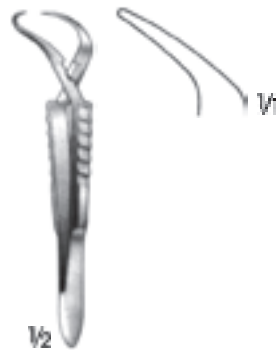

JONES
BE-3702
8.5 cm



SCHAEDEL
BE-3705 - BE-3710
8.5 cm





BACKHAUS-KOCHER
BE-4013
13.5 cm



ROEDER
BE-4102
13.5 cm

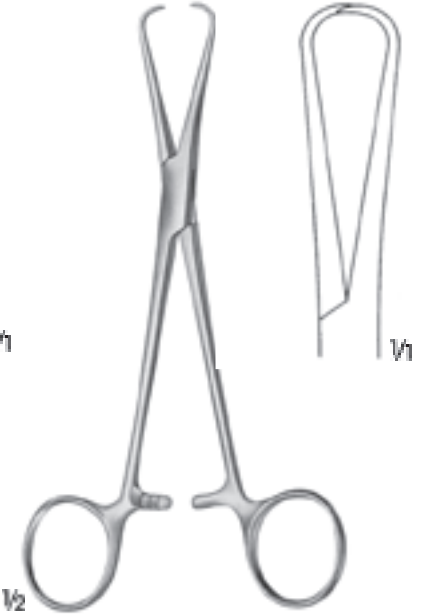

BERNHARD
BE-4104
16 cm

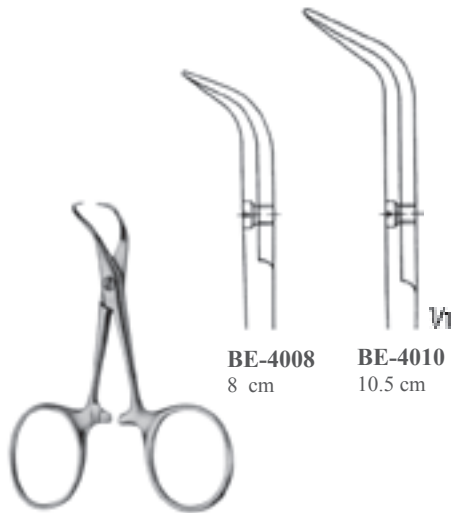

BACKHAUS
BE-4008 - BE-4010

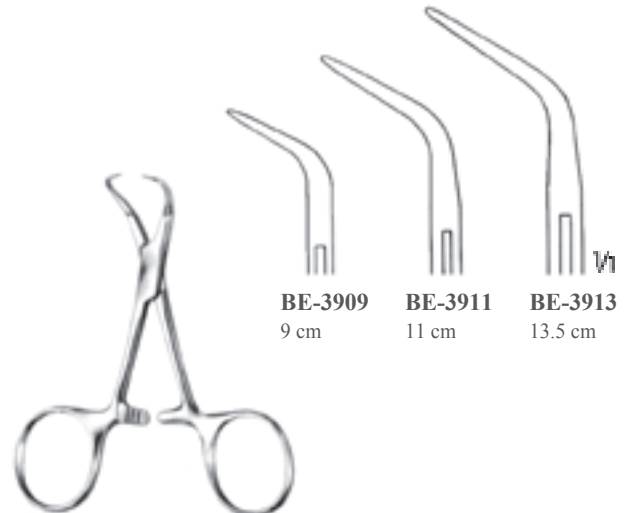

BACKHAUS
BE-3909 - BE-3913



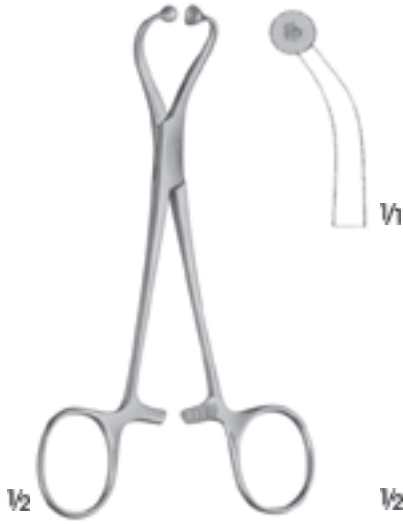

BE-4100
Kağıt örtüler için
For paper cloths
14 cm

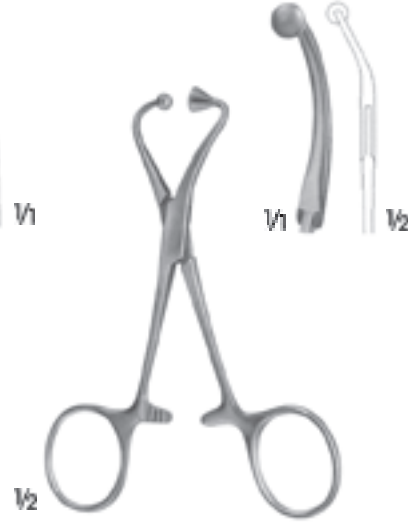

BE-4101
Kağıt örtüler için
For paper cloths
11.5 cm

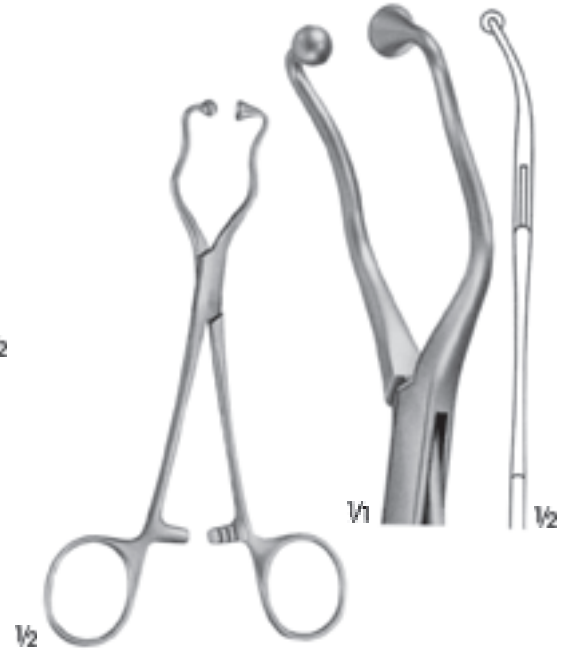

BE-4106
Tüp sabitleyici pens
Tube fixation forceps with
atraumatic jaw parts
14 cm



BE-4107
15 mm kadar tüp tutucu
With holders for tubing up to 15 mm
11 cm

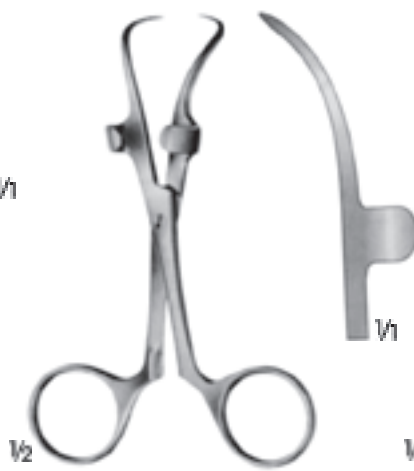

ROBIN
BE-4109
13 mm kadar tüp tutucu
With holders for tubing up to 13 mm
13.5 cm



ROBIN
BE-4108
5 mm kadar kablo tutucu
With holders for cable up to 5 mm
13.5 cm





BE-4113
Kağıt örtüler için
For paper cloths
15 cm

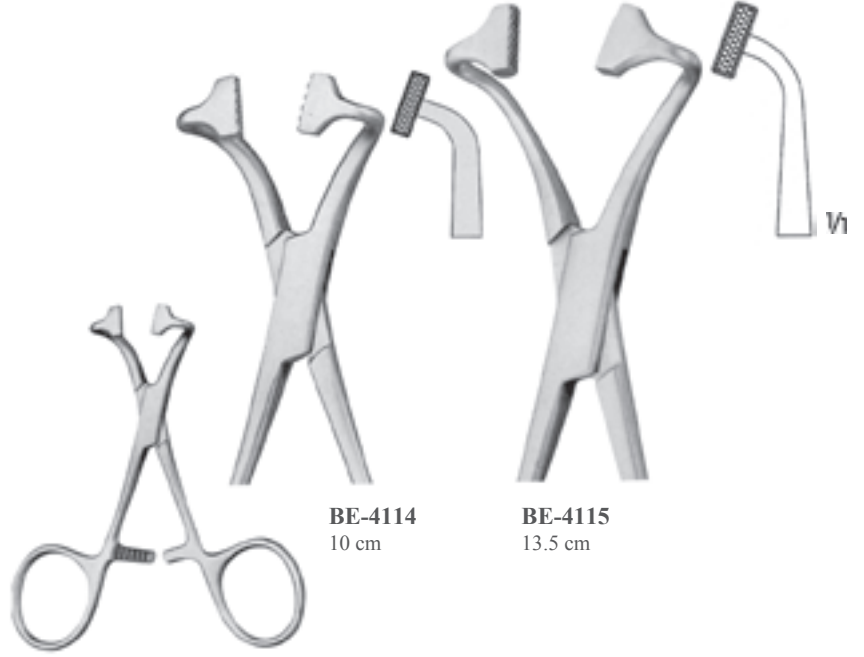

BE-4114
10 cm

BE-4115
13.5 cm

BE-4114 - BE-4115
Delmeden tutucu klemp
Non-perforating

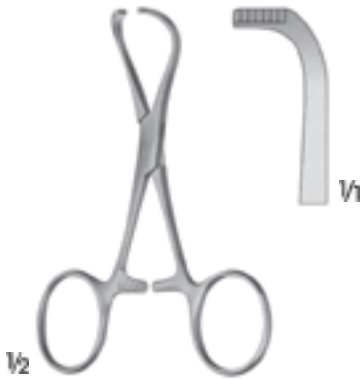

LORNA
BE-4110
Delmeden tutucu klemp
Non-perforating
9.5 cm

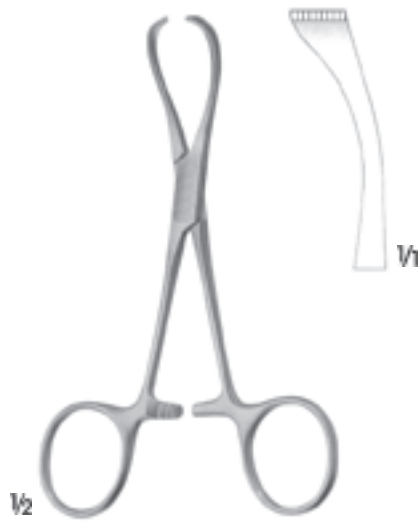

LORNA
BE-4111
Delmeden tutucu klemp
Non-perforating
13 cm

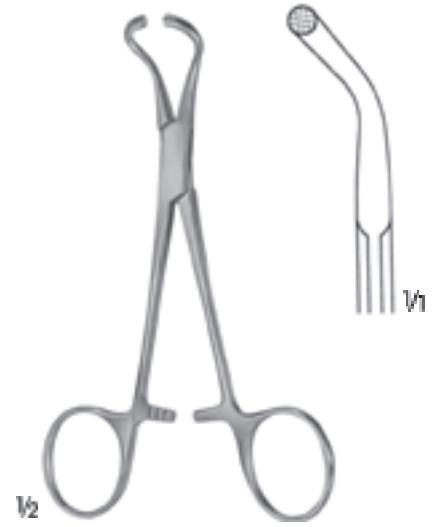

BE-4112
Bez örtüler için
For towel cloths
13.5 cm



CHEATTLE
BE-4300
Sterilizatör pensi
Sterilizing forceps
28 cm

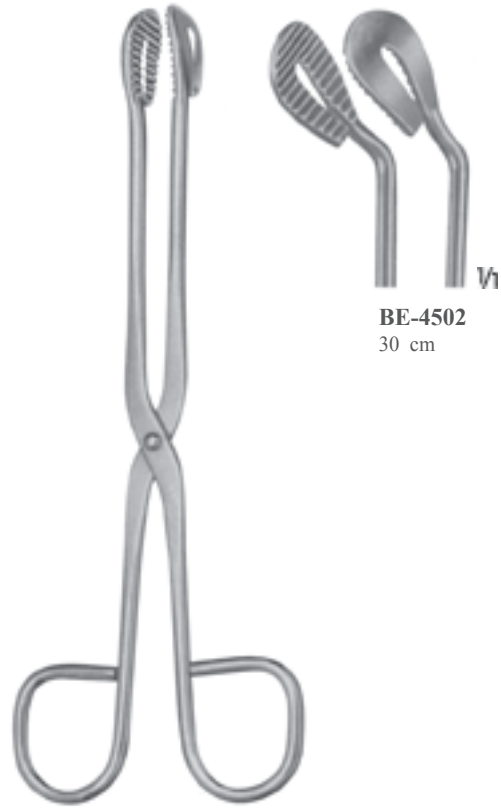

BE-4500 20 cm
BE-4501 30 cm
Sterilizatör pensleri
Sterilizing forceps

BE-4502
30 cm



BUNT
BE-4116
10.5 cm

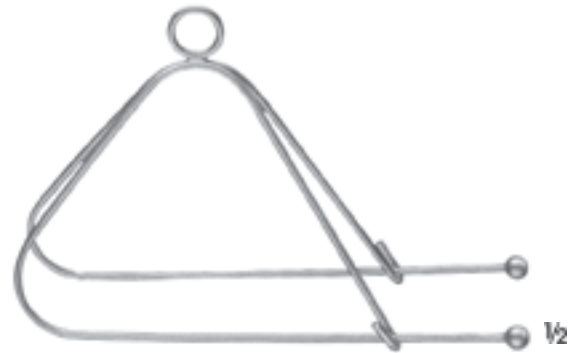

MAYO
BE-4201
Çift/double
12.5 cm



MAYO
BE-4200
14 cm





BF

Portegüler ve Sütur Aletleri
Needle Holders and Suture Instruments





Düz Saplar/Flat Handles

BF-1545

Kilitsiz/Without lock
20 cm

BF-1546

Kilitli/With lock
23 cm

BF-1545 - BF-1546

Yuvarlak saplı portegü
Needle holders
with round handles

Ergonomik, hafif plastik sap
yorulmadan optimum kullanım
sağlar.

Ergonomic, light weight plastic
handle provides fatigue free,
optimal usage.

MÜLLER

BF-1550

Kilitli/With lock
14.5 cm

MÜLLER

BF-1551

Kilitli/With lock
18 cm

BF-1100

BF-1101

BF-1200

BF-1201

BF-1202

BF-1203

BF-1300

BF-1301

CASTROVIEJO

BF-1100 - BF-1101

Kilitli/With lock
14.5 cm

BF-1200 - BF-1201

Kilitsiz/Without lock
Düz sap/flat handle
16 cm

BF-1202 - BF-1203

Kilitsiz/Without lock
18.5 cm

JACOBSON

BF-1300

Kilitsiz/Without lock
BF-1301 Kilitli/With lock
18.5 cm

BF-1400

Kilitli/With lock
20 cm

Yuvarlak Saplar
Parmaklar arasında istenildiği şekilde döndürmeye izin verir.
Sağlam veya oyulmuş saplardan dolayı her bir alette optimum denge sağlar

Round Handle
Allows rotation between the fingers as required
Due to carved and strong handle, each instrument provides optimum balance



BF-1510 - BF-1511
Kilitli/With lock
15 cm



REILL
BF-1520 - BF-1521
Kilitsiz/Without lock
15 cm



BF-1540 - BF-1541
Kilitsiz/Without lock
18.5 cm



BF-1542 - BF-1543
Kilitli/With lock
18.5 cm



BARRAQUER
BF-1500 - BF-1501
Kilitli/With lock
12 cm

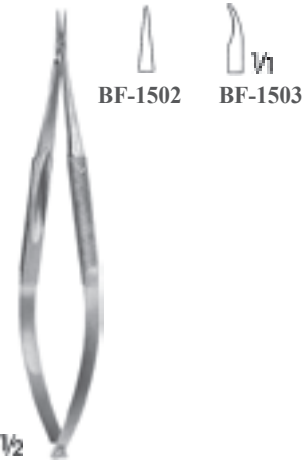

BARRAQUER
BF-1502 - BF-1503
Kilitsiz/Without lock
12 cm

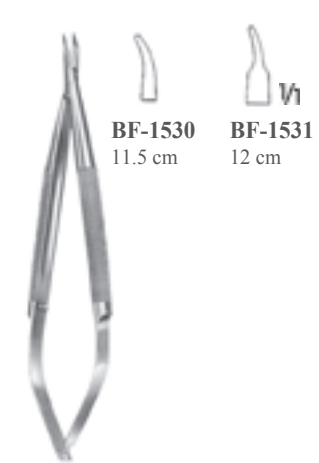

BARRAQUER
BF-1530 - BF-1531
Kilitsiz/Without lock



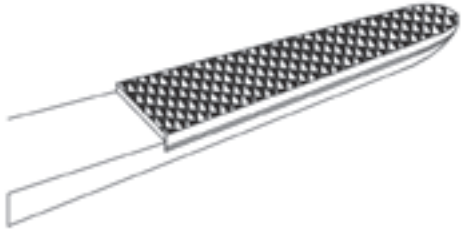

Elmas Uçlu Portegüler :

Portegülerin ağızlarındaki elmas uçlarının kullanıma göre yüzey yapısı seçilebilir.

Elmas uçlu portegülerin 4 farklı yüzeyi vardır. Pürüzsüz yüzey ve 3 farklı çentik yüzeyi uygun iğne yakalamayı sağlar.

Needle holders with carbide inserts.

The carbide inserts on needle holders can be selected based on usage.

Needle holders with carbide inserts have four different surface types. Smooth surface and three different notched surfaces provide appropriate needle catch.



Düz
smooth

Pürüzsüz yüzeye sahip ağızlarda kullanılacak, dikiş malzemesi için: 9/0 - 11/0

With smooth jaw surface for suture materials: 9/0 - 11/0



0.2

0.2 mm adımlı çentiğe sahip ağızda kullanılacak, dikiş malzemesi için: 6/0 - 10/0

With 0.2 mm pitch of serration for suture material: 6/0 - 10/0



0.4

0.4 mm adımlı çentiğe sahip ağızda kullanılacak, dikiş malzemesi için: 4/0 - 6/0

0.4 mm pitch of serration for suture material: 4/0 - 6/0



0.5

0.5 mm adımlı çentiğe sahip ağızda kullanılacak, dikiş malzemesi için: 3/0' a kadar

0.5 mm pitch of serration for suture material: up to 3/0

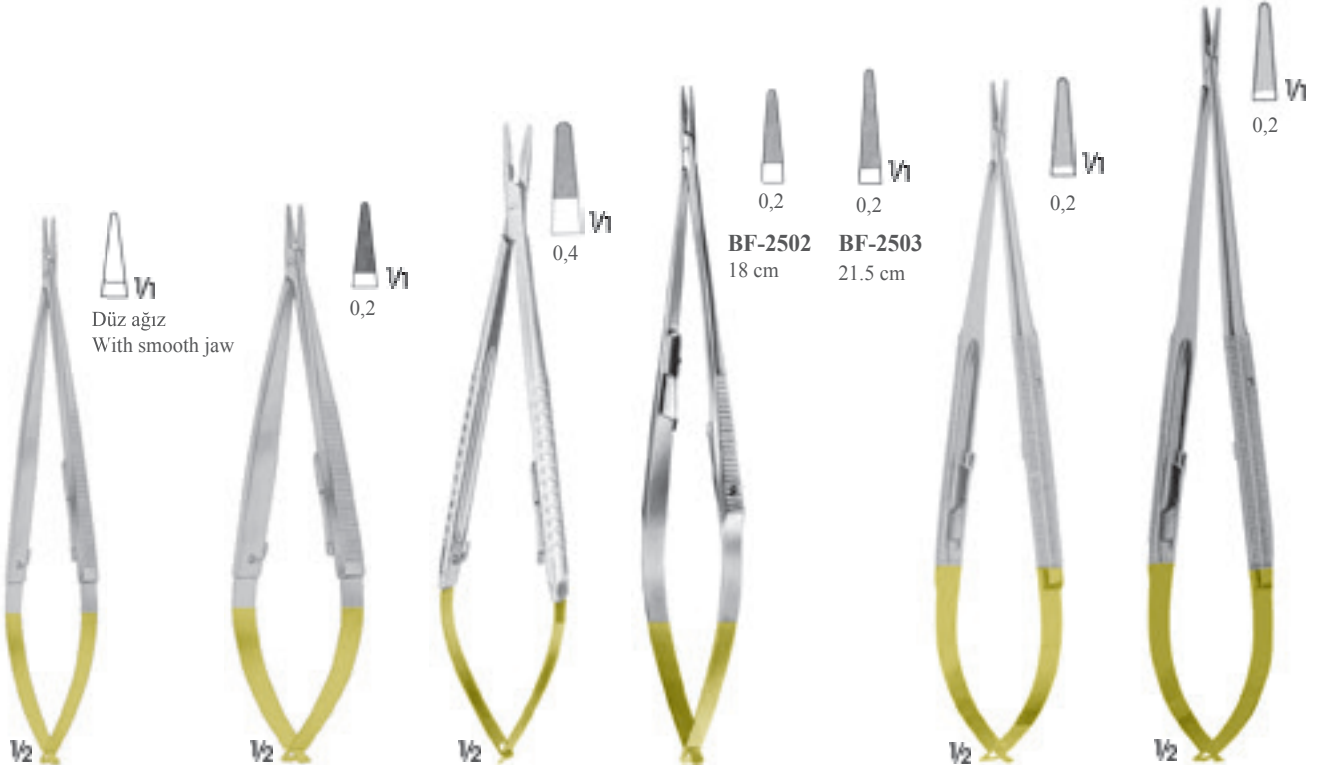

CASTROVIEJO BF-2500
Kilitli/With lock
14.5 cm

CASTROVIEJO BF-2501
Kilitli/With lock
14.5 cm

BF-4600
Kilitli/With lock
17 cm

CASTROVIEJO BF-2502 - BF-2503
Kilitli/With lock
14.5 cm

BF-2700
Kilitli/With lock
18 cm

BF-2701
Kilitli/With lock
20 cm

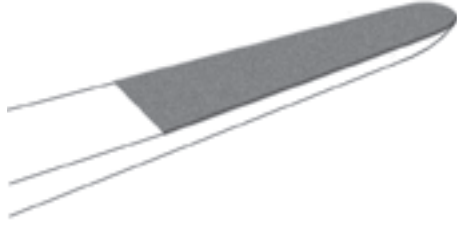

DIAPOWDER ağızlar, daha sert ve aşınmaya dayanıklı yüzeyler sağlar.
DIAPOWDER ağızlar, hassas iğne, suture ve dokuların güvenilir bir şekilde kavranmasını garanti eder.

DIAPOWDER jaws provide harder and more wear resistant surfaces.
DIAPOWDER jaws ensure reliable grip of fine needles, sutures and tissues.



BF-2600

BF-2601

 $\frac{1}{2}$

BF-2600 - BF-2601
Kilitli/With lock
18 cm

 $\frac{1}{2}$

Suture 5-0 ve daha
küçükler için
For sutures 5-0
and smaller

 $\frac{1}{2}$

BF-3421
Kilitli/With lock
21 cm

 $\frac{1}{2}$

Suture 5-0 ve daha
küçükler için
For sutures 5-0
and smaller

 $\frac{1}{2}$

BF-3521
Kilitsiz/Without lock
21 cm



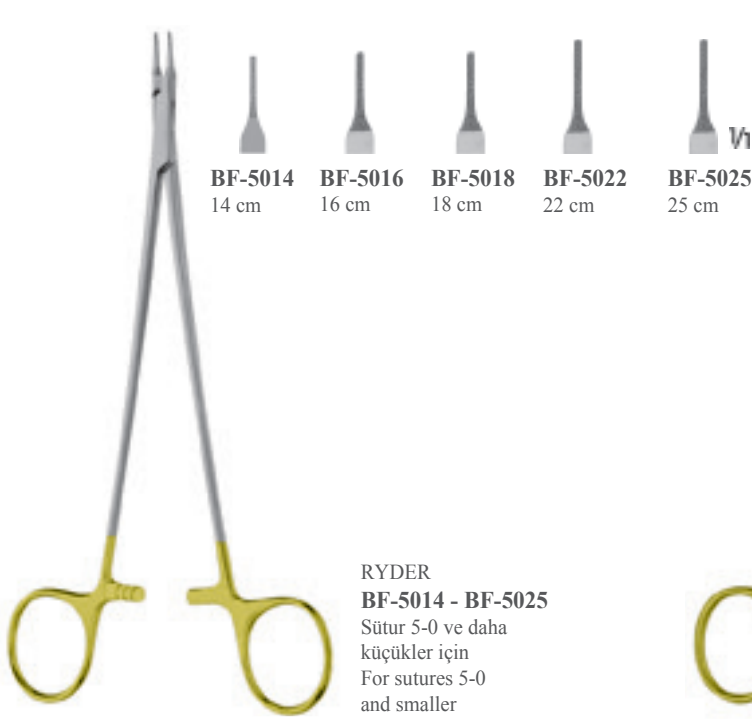

BF-5014 14 cm
BF-5016 16 cm
BF-5018 18 cm
BF-5022 22 cm
BF-5025 25 cm

RYDER
BF-5014 - BF-5025
Sütür 5-0 ve daha küçükler için
For sutures 5-0 and smaller

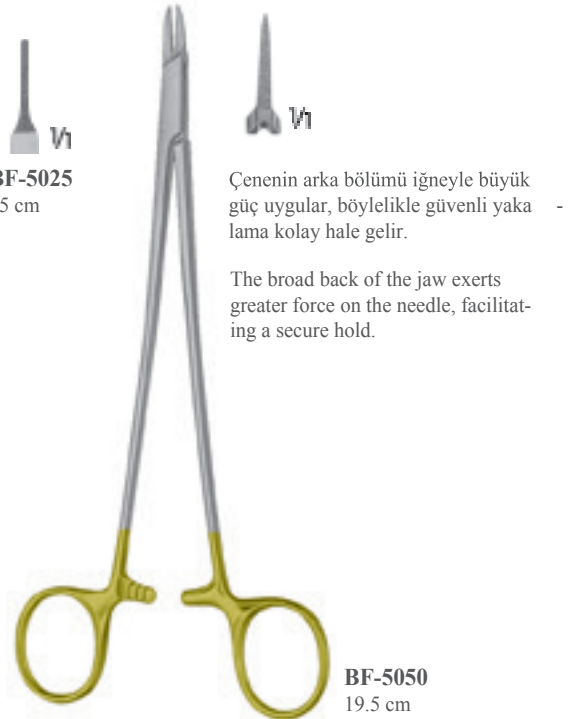

Çenenin arka bölümü iğneyle büyük güç uygular, böylelikle güvenli yakalama kolay hale gelir.

The broad back of the jaw exerts greater force on the needle, facilitating a secure hold.

BF-5050
19.5 cm

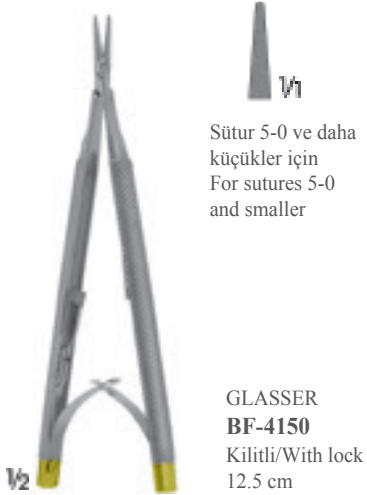

Sütür 5-0 ve daha küçükler için
For sutures 5-0 and smaller

GLASSER
BF-4150
Kilitli/With lock
12.5 cm



Sütür 5-0 ve daha küçükler için
For sutures 5-0 and smaller

GLASSER
BF-4155
Kilitli/With lock
18 cm



Sütür 7-0 ve daha
küçükler için
For sutures 7-0
and smaller

18.5 cm **BF-4618**
21 cm **BF-4621**
23 cm **BF-4623**
Kilitli/With lock

18.5 cm **BF-4718**
21 cm **BF-4721**
23 cm **BF-4723**
Kilitsiz/Without lock



Sütür 5-0 ve daha
küçükler için
For sutures 5-0
and smaller

18.5 cm **BF-4818**
21 cm **BF-4821**
23 cm **BF-4823**
Kilitli/With lock

18.5 cm **BF-4918**
21 cm **BF-4921**
23 cm **BF-4923**
Kilitsiz/Without lock



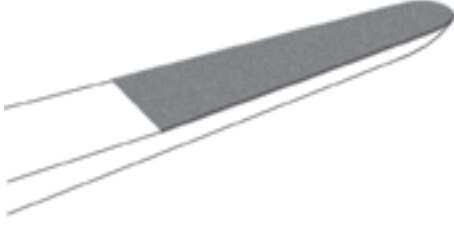

DIAPOWDER ağızlar, daha sert ve aşınmaya dayanıklı yüzeyler sağlar.
DIAPOWDER ağızlar, hassas iğne, suture ve dokuların güvenilir bir şekilde kavranmasını garanti eder.

DIAPOWDER jaws provide harder and more wear resistant surfaces.
DIAPOWDER jaws ensure reliable grip of fine needles, sutures and tissues.



Suture 2-0 ve daha küçükler için
For sutures 2-0 and smaller



19 cm **BF-3619**
23 cm **BF-3623**
25 cm **BF-3625**

BF-3619 - BF-3625
Kilitli/Without lock



Suture 2-0 ve daha küçükler için
For sutures 2-0 and smaller



19 cm **BF-3719**
23 cm **BF-3723**
25 cm **BF-3725**

BF-3719 - BF-3725
Kilitli/With lock



Suture 7-0 ve daha küçükler için
For sutures 7-0 and smaller



12 cm **BF-2812**
14.5 cm -
16 cm **BF-2816**
18.5 cm **BF-2818**
21 cm **BF-2821**
23 cm **BF-2823**

BF-2812 - BF-2823
Kilitli/Without lock

Suture 5-0 ve daha küçükler için
For sutures 5-0 and smaller



-
BF-2914
BF-2916
BF-2918
BF-2921
BF-2923



Suture 7-0 ve daha küçükler için
For sutures 7-0 and smaller



12 cm **BF-3012**
14.5 cm -
16 cm **BF-3016**
18.5 cm **BF-3018**
21 cm **BF-3021**
23 cm **BF-3023**

BF-3012 - BF-3023
Kilitli/With lock

Suture 5-0 ve daha küçükler için
For sutures 5-0 and smaller



-
BF-3114
BF-3116
BF-3118
BF-3121
BF-3123

Suture 4-0 ve daha küçükler için
For sutures 4-0 and smaller



-
-
-
BF-3218
BF-3221
BF-3223

Suture 4-0 ve daha küçükler için
For sutures 4-0 and smaller

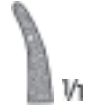

-
-
-
-
BF-3321
BF-3323

Kanallı Düz Sap/Flat Knurled Handle



Sütür 5-0 ve daha
küçükler için
For sutures 5-0
and smaller



18.5 cm **BF-4418**
21 cm **BF-4421**
23 cm **BF-4423**

BF-4418 - BF-4423
Kilitsiz/Without lock



Sütür 5-0 ve daha
küçükler için
For sutures 5-0
and smaller



18.5 cm **BF-4518**
21 cm **BF-4521**
23 cm **BF-4523**

BF-4518 - BF-4523
Kilitli/With lock

Düz Sap/Flat Handle



Sütür 7-0 ve daha
küçükler için
For sutures 7-0
and smaller



14.5 cm -
17 cm **BF-4200**
18.5 cm -
21 cm -
23 cm -

BF-4200 - BF-4223
Kilitsiz/Without lock

Sütür 5-0 ve daha
küçükler için
For sutures 5-0
and smaller



BF-4214
-
BF-4218
BF-4221
BF-4223



Sütür 7-0 ve daha
küçükler için
For sutures 7-0
and smaller



14.5 mm -
17 cm **BF-4300**
18.5 cm -
21 cm -
23 cm -

BF-4300 - BF-4323
Kilitli/With lock

Sütür 5-0 ve daha
küçükler için
For sutures 5-0
and smaller



BF-4314
-
BF-4318
BF-4321
BF-4323





DERF
BF-1615
12.5 cm



BAUMGARTNER
BF-1621
14.5 cm



LAWRENCE
BF-1623
15 cm

Hassas ağız
Delicate jaw



WEBSTER
BF-1600
12.5 cm

Düz ağız
Smooth jaw

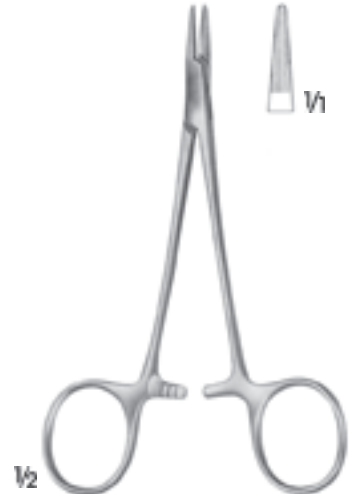

CONVERSE
BF-1601
13 cm



BF-1605
Düz ağız
Smooth jaws

BF-1606

HALSEY
BF-1605 - BF-1606
13 cm

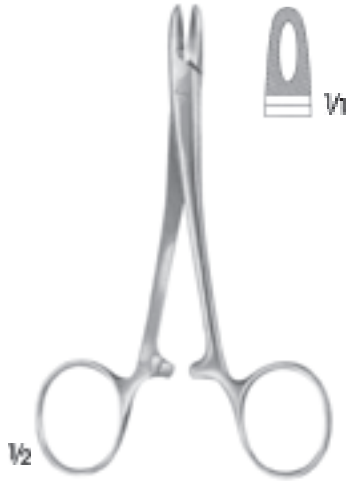

DOYEN
BF-1620
12.5 cm

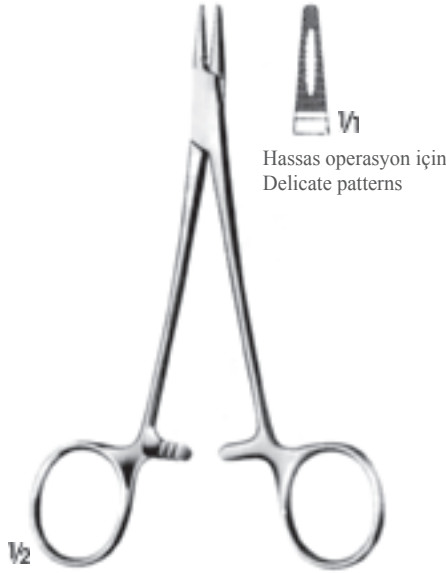

Hassas operasyon için
Delicate patterns

CRILE-WOOD
BF-1630
15 cm

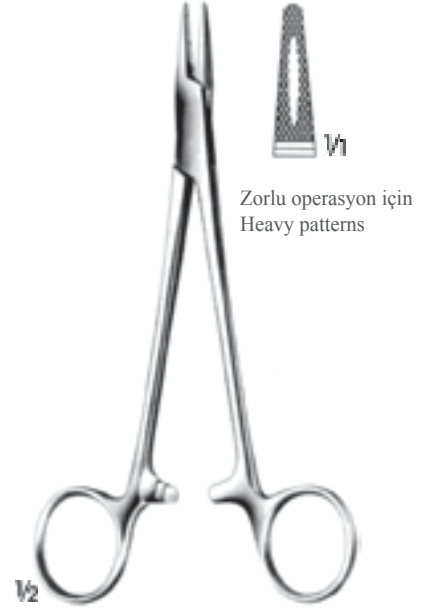

Zorlu operasyon için
Heavy patterns

CRILE-WOOD
BF-1631
16 cm



KILNER
BF-1645
13.5 cm

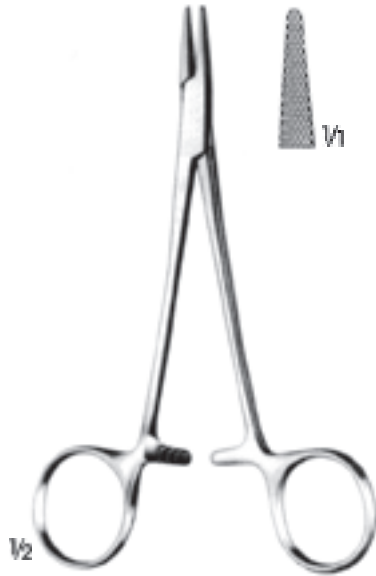

CRILE-MURRAY
BF-1632
15 cm

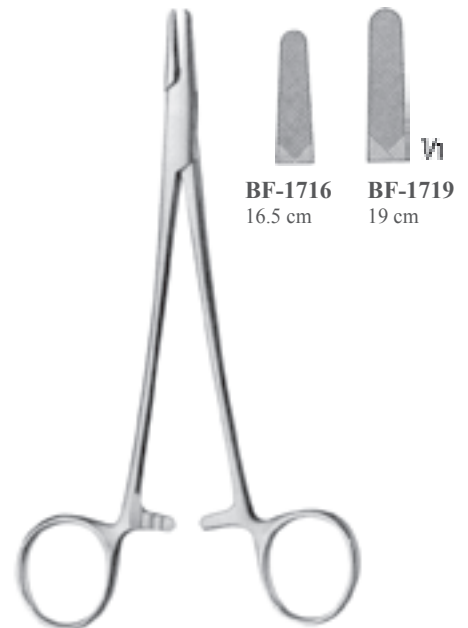

BF-1716
16.5 cm

BF-1719
19 cm

MAYO-HEGAR
BF-1716 - BF-1719





Ön ve damak için dikiş pensi
Designed for frontal and palate
suture

ADSON
BF-1930
17.5 cm



HEANEY
BF-1935
20 cm



JAMESON
BF-1940
23 cm



MAYO-HEGAR
BF-1815 - BF-1826
Orta incelikte dikiş pensi
Medium fine patterns

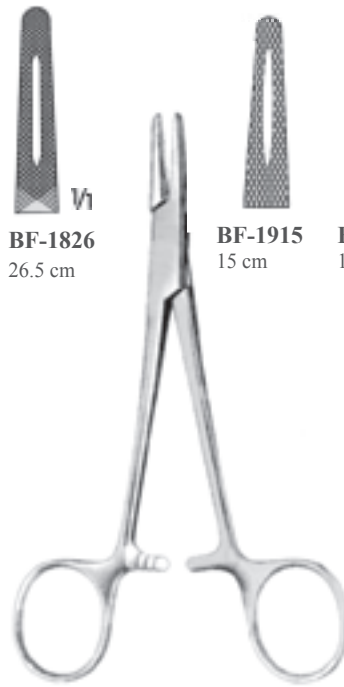

HEGAR
BF-1915 - BF-1921
Zorlu operasyon için
Heavy patterns





MASSON-LUETHY
BF-1955
25.5 cm



WANGENSTEEN
BF-1945
27.5 cm



MASSON
BF-1950
26.5 cm





GILLIES
BF-2115
15 cm



GILLIES
BF-2116
16 cm



HEGAR-OLSEN
BF-2014 - BF-2018

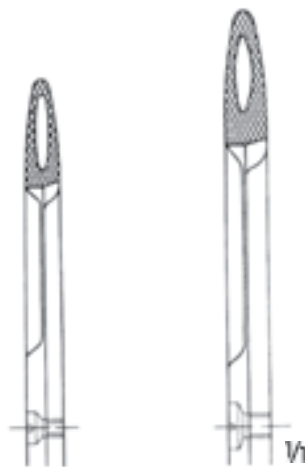

BF-2014
14 cm

BF-2018
18.5 cm



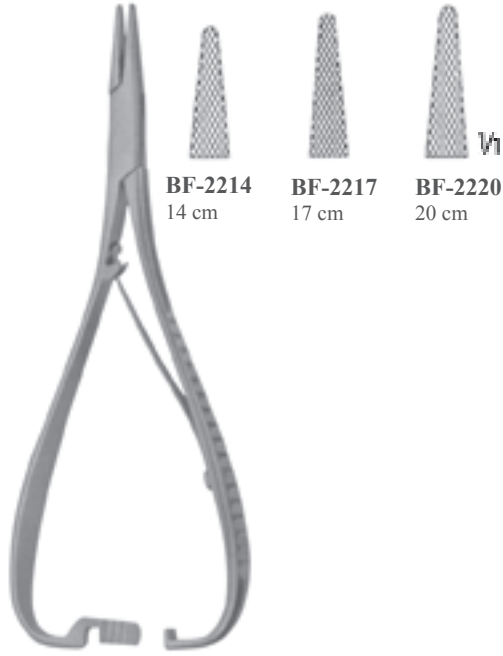

MATHIEU
BF-2214 - BF-2220

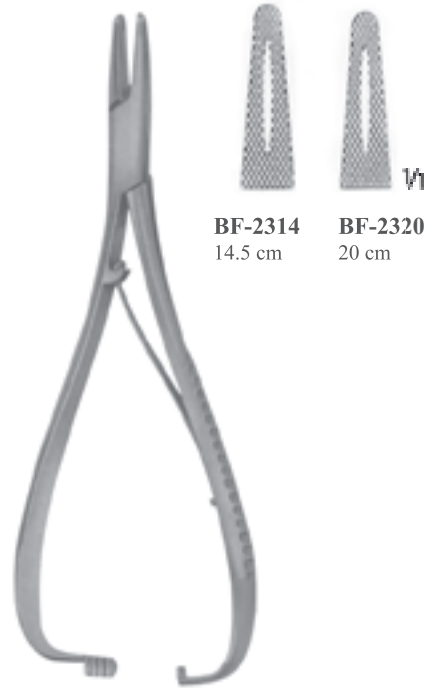

MATHIEU -STILLE
BF-2314 - BF-2320
Çok zorlu operasyon için
Very heavy patterns



CRILE
BF-1960
15 cm



TÖNNIS
BF-1965
Dura ve bağırsak dikiş pensı
Elastic pattern for dura-or intestinal suture
18 cm



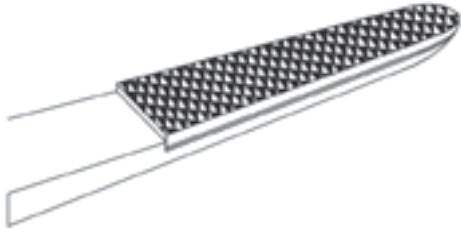

Elmas Uçlu Portegüler :

Portegülerin ağızlarındaki elmas uçlarının kullanıma göre yüzey yapısı seçilebilir.

Elmas uçlu portegülerin 4 farklı yüzeyi vardır. Pürüzsüz yüzey ve 3 farklı çentik yüzeyi uygun iğne yakalamayı sağlar.

Needle holders with carbide inserts.

The carbide inserts on needle holders can be selected based on usage.

Needle holders with carbide inserts have four different surface types. Smooth surface and three different notched surfaces provide appropriate needle catch.



Düz
smooth

Pürüzsüz yüzeye sahip ağızlarda kullanılacak, dikiş malzemesi için: 9/0 - 11/0

With smooth jaw surface for suture materials: 9/0 - 11/0



0.2

0.2 mm adımlı çentiğe sahip ağızda kullanılacak, dikiş malzemesi için: 6/0 - 10/0

With 0.2 mm pitch of serration for suture material: 6/0 - 10/0



0.4

0.4 mm adımlı çentiğe sahip ağızda kullanılacak, dikiş malzemesi için: 4/0 - 6/0

0.4 mm pitch of serration for suture material: 4/0 - 6/0



0.5

0.5 mm adımlı çentiğe sahip ağızda kullanılacak, dikiş malzemesi için: 3/0' a kadar

0.5 mm pitch of serration for suture material: up to 3/0



HALSEY
BF-5055
12 cm



Düz ağız
With smooth jaw



WEBSTER
BF-5060
12.5 cm



Düz ağız
With smooth jaws



MASING
BF-5065
Tek ayağı açılı, yüzüklü
One ring angled
13 cm



0,4

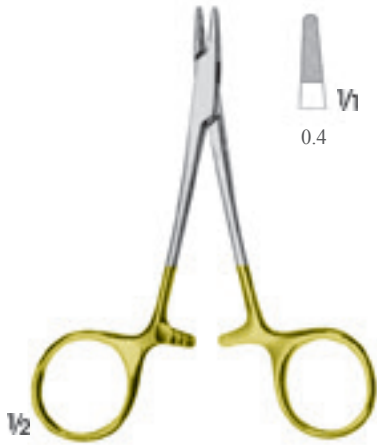

DERF
BF-5070
11.5 cm



HALSEY
BF-5125
13 cm

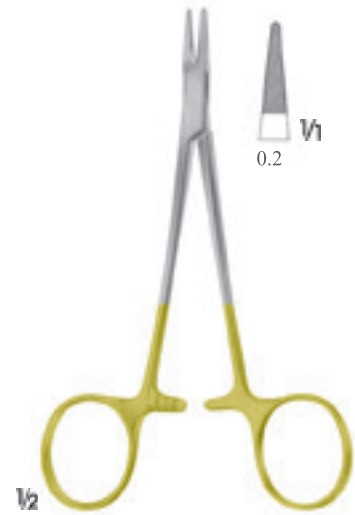

CONVERSE
BF-5130
13 cm

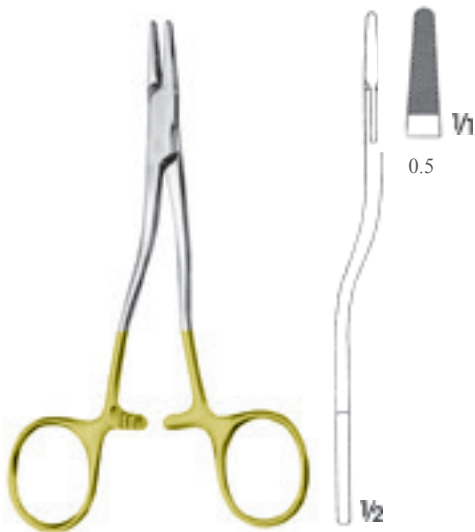

KILNER
BF-5140
13.5 cm

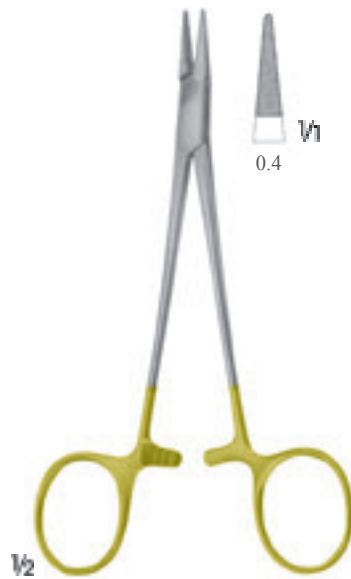

BABY-CRILE-WOOD
BF-5135
15 cm



BAUMGARTNER
BF-5145
14.5 cm





Super Cut

Model	Length (cm)	Tip Width (mm)
BF-5300	16.5	0.4
BF-5301	21	0.4
BF-5302	16.5	0.2
BF-5303	21	0.2
BF-5303 W	21	0.2

DE BAKEY
BF-5300 - BF-5303
Çok hassas/Very delicate

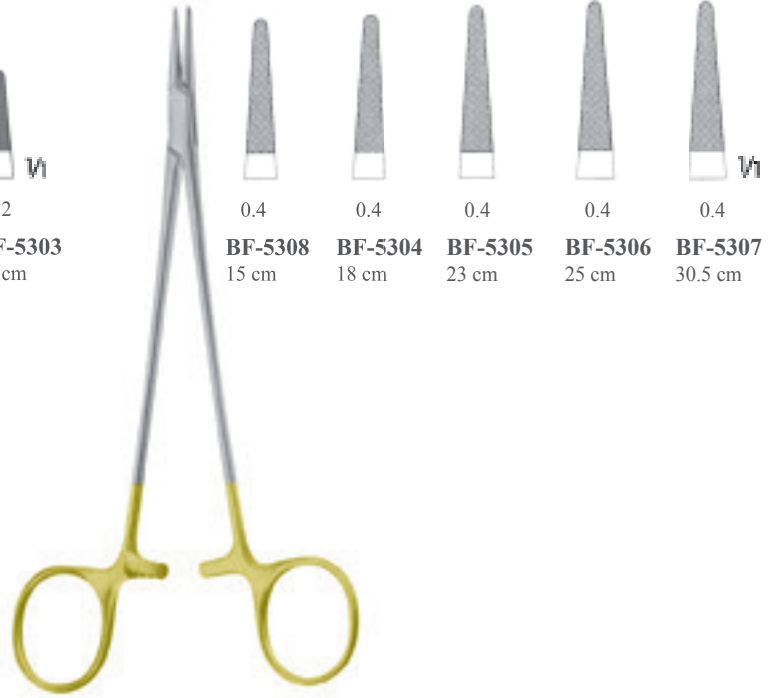

Super Cut

Model	Length (cm)	Tip Width (mm)
BF-5308	15	0.4
BF-5304	18	0.4
BF-5305	23	0.4
BF-5306	25	0.4
BF-5307	30.5	0.4

DE BAKEY
BF-5304 - BF-5308



Model	Length (cm)	Tip Width (mm)
BF-5214	14.5	0.4
BF-5218	18.5	0.4
BF-5220	20	0.4
BF-5227	27	0.4
BF-5230	30.5	0.4

CRILE-WOOD
BF-5214 - BF-5230

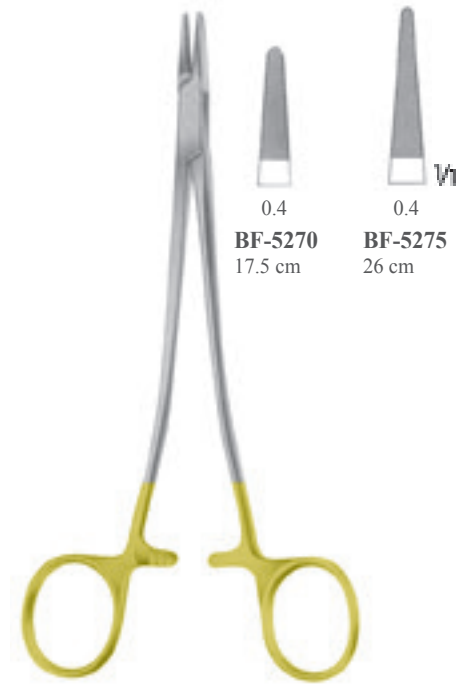

Model	Length (cm)	Tip Width (mm)
BF-5270	17.5	0.4
BF-5275	26	0.4

SAROT
BF-5270 - BF-5275



BF-5310 - BF-5312
Çok hassas/Very delicate

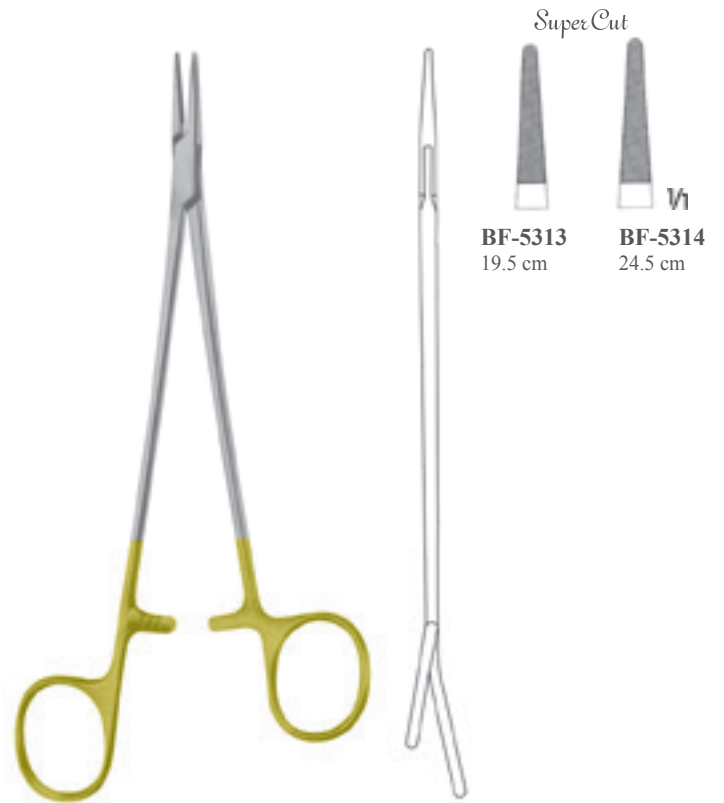

DE BAKEY
BF-5313 - BF-5314
Uzatılmış bir sap ve kavisli yüzükler,
optimum tutuş sağlar.
One extended handle and curved
rings ensure optimum grip

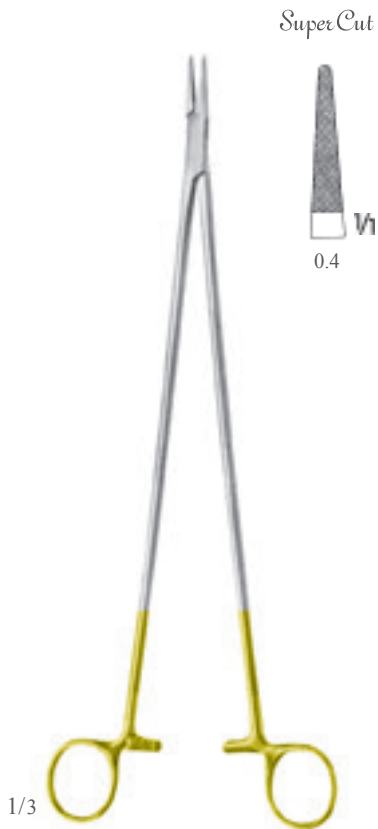

DE BAKEY
BF-5309
Narin model/Slender patterns
30.5 cm



HEGAR-MAYO-SEELEY
BF-5455
20 cm





HEGAR-MAYO
BF-5415 - BF-5430

- | | | | | | | |
|----------------|----------------|----------------|----------------|----------------|----------------|-----|
| | | | | | | |
| 0.5 | 0.5 | 0.5 | 0.5 | 0.5 | 0.5 | 1/1 |
| BF-5415 | BF-5418 | BF-5420 | BF-5423 | BF-5426 | BF-5430 | |
| 15 cm | 18.5 cm | 20.5 cm | 23.5 cm | 26.5 cm | 30 cm | |

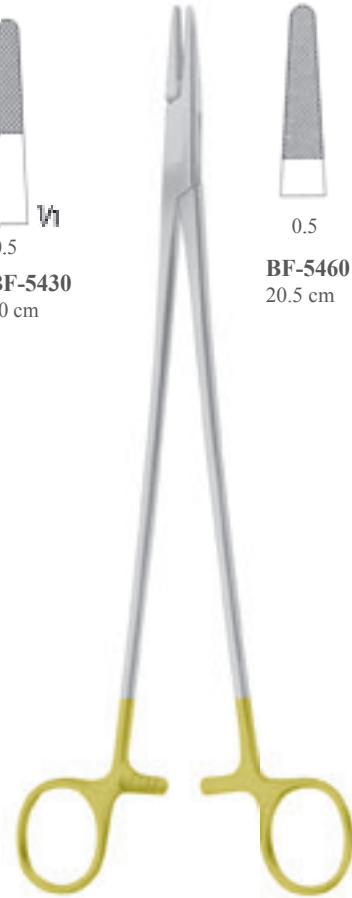

HEGAR
BF-5460 - BF-5465
Zorlu operasyon için
Heavy patterns

- | | | |
|----------------|----------------|-----|
| | | |
| 0.5 | 0.5 | 1/1 |
| BF-5460 | BF-5465 | |
| 20.5 cm | 24.5 cm | |



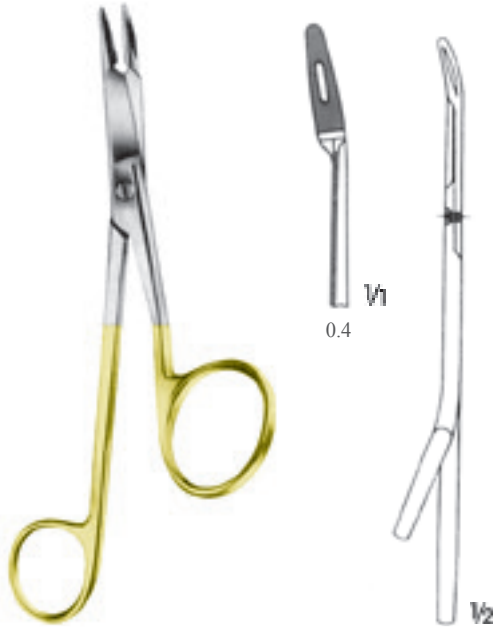

GILLIES
BF-5291
16 cm

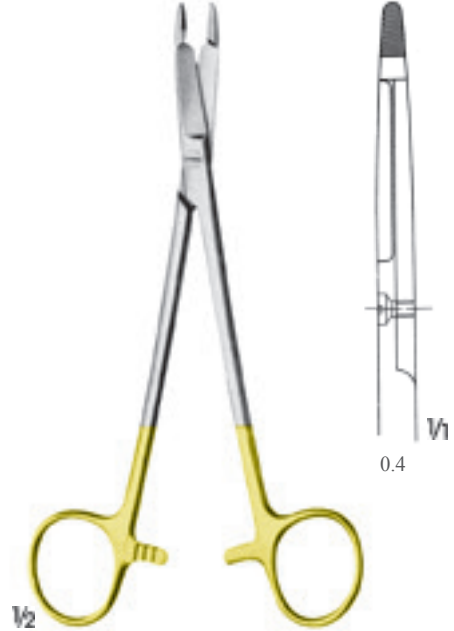

HEGAR-OLSEN
BF-5295
Tek ağız tırtıllı
one blade fine serrated
16.5 cm



Düz Ağız
With smooth jaw

BF-5285
12.5 cm

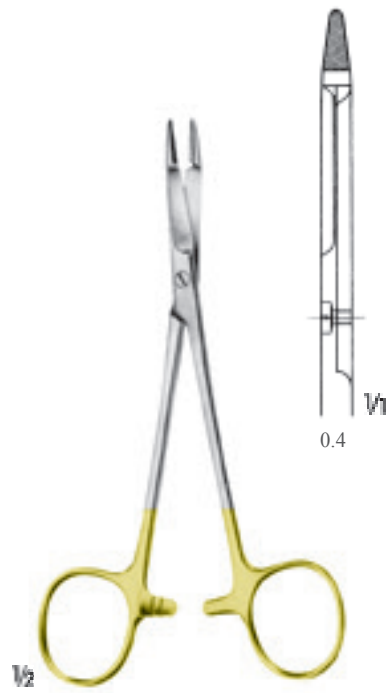

HEGAR-HELSON
BF-5290
14.5 cm



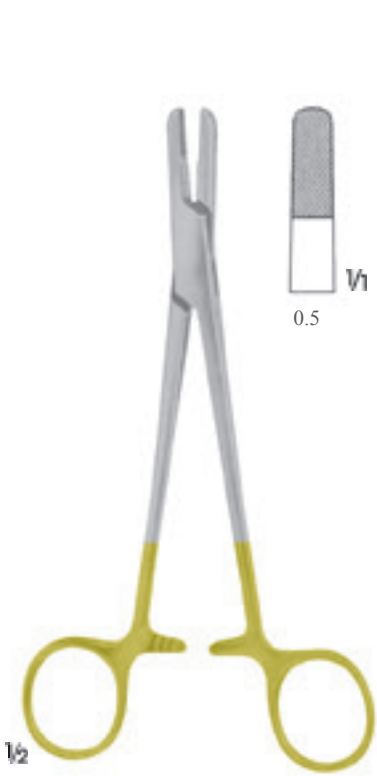

BF-5265
Tel Bükücü/ Wire twister
Sternum suture için ligatür pensi
Sternum suture for ligature forceps
17.5 cm

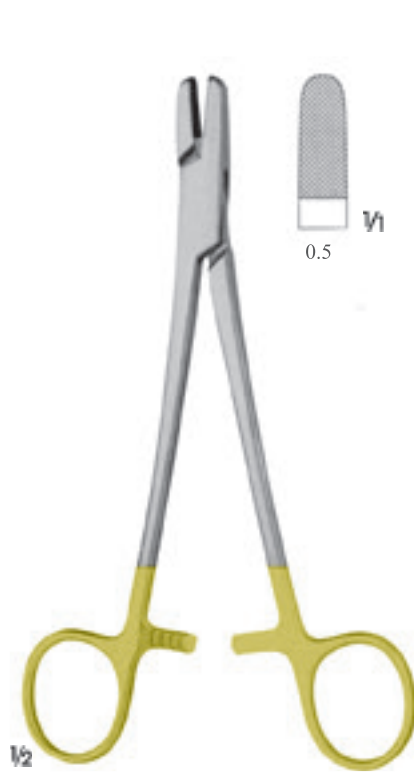

BERRY
BF-5255
Tel bükücü /Wire twister
Ligatür pensi/Ligature forceps
18.5 cm



BAUMGARTNER
BF-5280
Tel bükücü /Wire twister
Ligatür pensi/Ligature forceps
20 cm

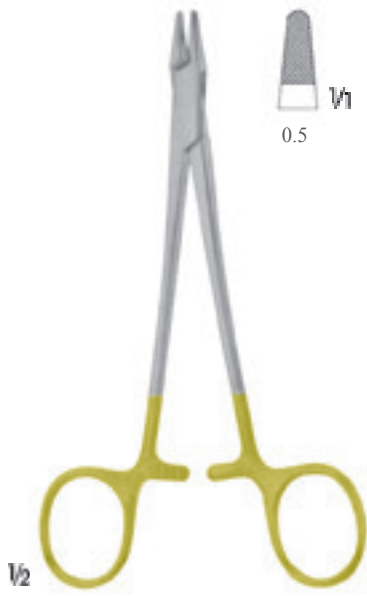

BF-5250
Tel bükücü /Wire twister
15 cm



BF-5260
Tel bükücü /Wire twister
15 cm

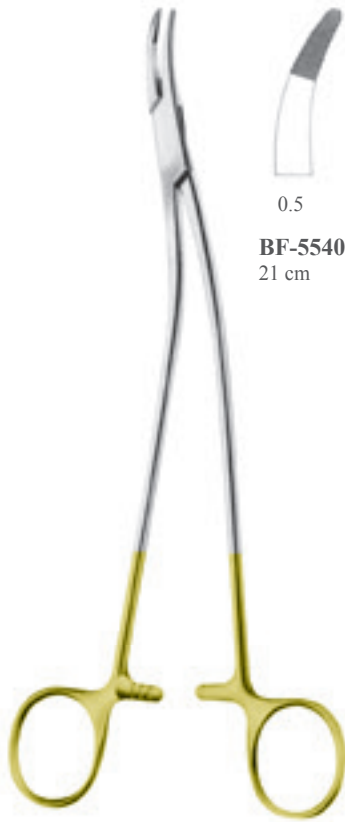

BF-5540
21 cm



0.5



0.5

BF-5560
23 cm

STRATTE
BF-5540 - BF-5560



BF-5575
S şekli portegü/S-shaped needle holder
21.5 cm



0.5



1/2



WERTHEIM
BF-5520 - BF-5530



0.5

BF-5520
20 cm



0.5

BF-5524
24 cm



0.5

BF-5530
30 cm



HEANEY
BF-5570 - BF-5571



0.5

BF-5570
20 cm



0.5

BF-5571
26 cm



MASSON
BF-5475
26.5 cm



WANGENSTEEN
BF-5470
27.5 cm



BF-5565
27.5 cm



$\frac{1}{2}$
MÜLLER
BF-5316
Derin rektum cerrahisi için
For deep rectum surgery
36 cm

$\frac{1}{2}$
FINOCHIETTO
BF-5480
26.5 cm

$\frac{1}{2}$
NAUNTON-MORGAN
BF-5315
26 cm

- Hassas çeneler travmatik olmayan ve hassas damar iğnelerini tutmak için uygundur.
- Fine jaws are suitable for gripping non-traumatic needles and vein needles.

Super Cut



RYDER
BF-5613 - BF-5623
Çok hassas/Very delicate



0.2
BF-5613
13.5 cm



0.2
BF-5615
15.5 cm



0.2
BF-5617
17.5 cm



0.2
BF-5621
21 cm



0.2
BF-5623
23 cm



RYDER
BF-5713 - BF-5726



0.4
BF-5713
13.5 cm



0.4
BF-5717
17.5 cm



0.4
BF-5719
19.5 cm



0.4
BF-5726
26.5 cm



BF-5765
18 cm



BF-5760
20 cm



RYDER
BF-5115 - BF-5123
Düz ağız/With smooth jaws



BF-5115
15 cm



BF-5118
18 cm



BF-5123
23 cm



- Cerraha maksimum ergonomik rahatlık sağlar.
- Optimize tasarımları sayesinde zor suture ve anastomoz tekniklerinde yorulmadan çalışmayı sağlar.
- Provides maximum ergonomic comfort to surgeon.
- Due to optimized design, it provides fatigue free working on suture and anastomosis techniques.



**REIN-KUPKA
BF-5750**
Kilitsiz/Without ratchet lock
19 cm



**REIN-KUPKA
BF-5751**
Kilitli/With ratchet lock
19 cm



**HELLBERG-KUPKA
BF-5775**
Kilitli/ With ratchet lock
21 cm



LANGENBECK
BF-5918 - BF-5920

Super Cut



LANGENBECK
BF-6020
Elastik model/Elastic patterns
20 cm



TÖNNIS
BF-5770
Elastik model/Elastic patterns
18 cm



TÖNNIS
BF-5755
Elastik model/Elastic patterns
18 cm





0.5 0.5
BF-6220 20 cm
BF-6224 24.5 cm

MATHIEU
BF-6220 - BF-6224
Zorlu operasyon için
Heavy patterns



0.4
V1

BF-6300
Uzun boyunlu
With long neck
20.5 cm



SuperCut
0.5
V1

LICHTENBERG
BF-6303
Elastik model
Elastic patterns
19.5 cm



SuperCut

0.4 0.4 0.4
BF-5814 14 cm
BF-5817 17 cm
BF-5820 20 cm

MATHIEU
BF-5814 - BF-5820
Hassas model/Delicate patterns



0.5 0.5 0.5
BF-6114 14 cm
BF-6117 17 cm
BF-6120 20 cm

MATHIEU
BF-6114 - BF-6120
Standart model/Standard patterns

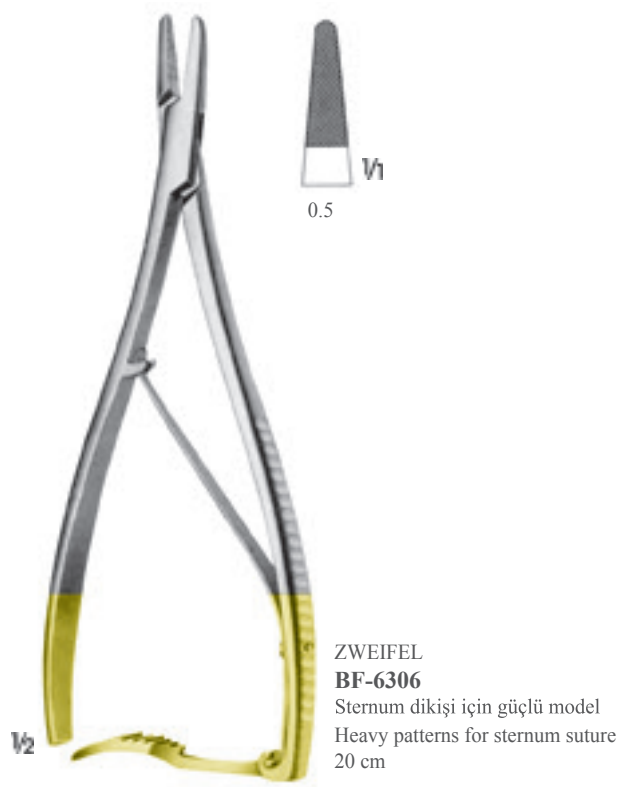
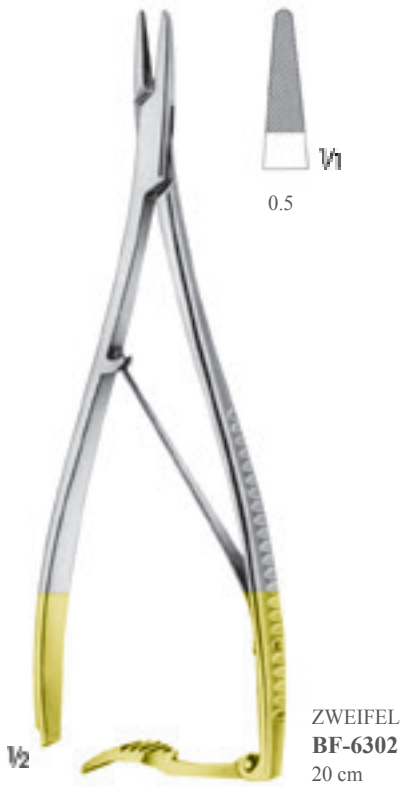



V₂

MILLIN
BF-6320
Ligatür tutucu pens
Ligature holding forceps
28.5 cm



V₂

YOUNG-HRYNTSCHAK
BF-6310
1 iğne ile BF-6307
With 1 needle BF-6307
24 cm



V₁

BF-6307



V₁

BF-6308



V₁

BF-6309

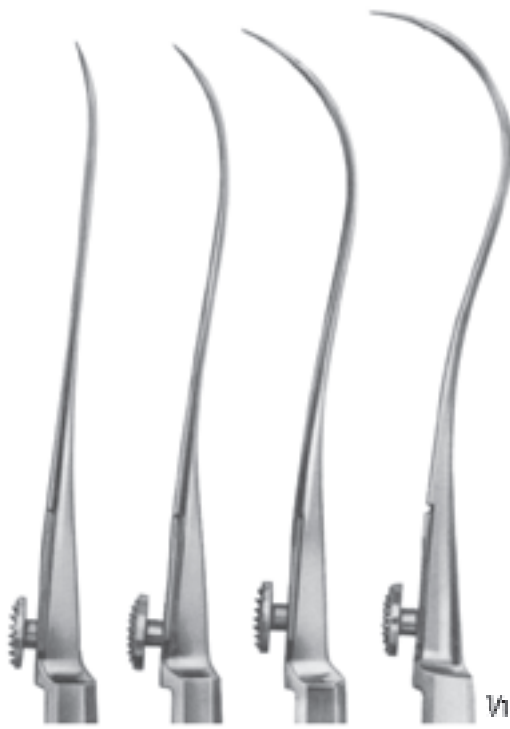

BF-6401 BF-6402 BF-6403 BF-6404



BF-6501 BF-6502 BF-6503 BF-6504



REVERDIN
BF-6401 - BF-6404 19.5 cm
BF-6501 - BF-6504 22 cm





KRONECKER
BF-6600
Sağ el için, künt
For right hand blunt
BF-6601
Sol el için, künt
For left hand blunt
15.5 cm



DESCHAMPS
BF-6602
Sağ el için, sivri
For right hand sharp
BF-6603
Sol el için, künt
For left hand sharp
21 cm



HURD
BF-6604
Sağ el için, sivri
For right hand sharp
BF-6605
Sol el için, künt
For left hand sharp
21 cm

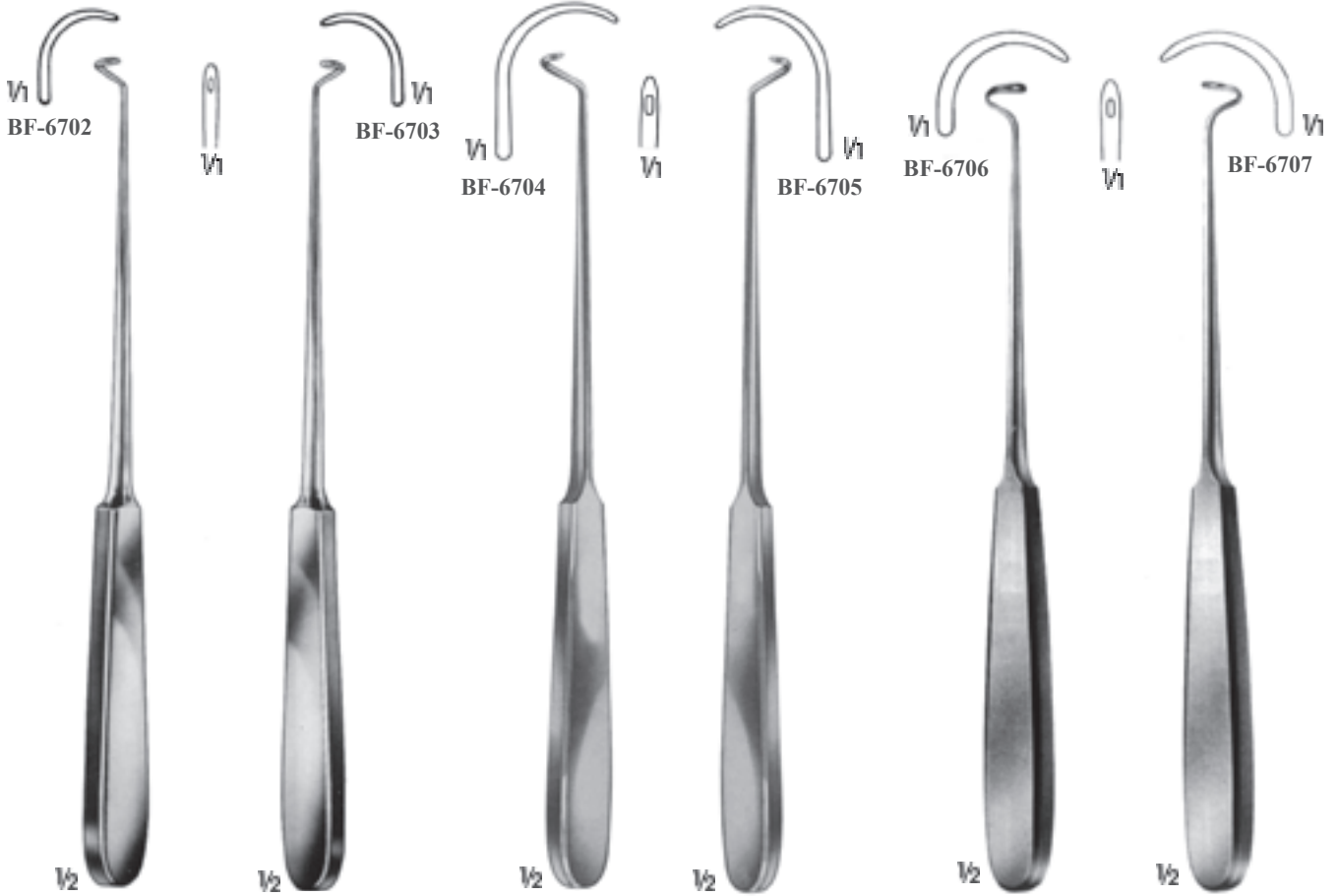

DESCHAMPS
BF-6702
Sağ el için, künt
For right hand blunt
BF-6703
Sol el için, künt
For left hand blunt
22.5 cm

DESCHAMPS
BF-6704
Sağ el için, künt
For right hand blunt
BF-6705
Sol el için, künt
For left hand blunt
22.5 cm

DESCHAMPS
BF-6706
Sağ el için, künt
For right hand blunt
BF-6707
Sol el için, künt
For left hand blunt
21.5 cm



Sakrospinöz Fiksasyon Aleti; Jinekolojik cerrahide pelvik organ prolapsusu tedavisi için sakrospinöz fiksasyon ameliyatında, geniş cerrahi diseksiyona gerek kalmadan minimum doku travması ile ipliği o bölgeden geçirme özelliğine sahiptir.

Sacrospinous fixation instruments; It has the ability to pass the thread from the tissue by minimal tissue trauma without requiring extensive surgical dissection in gynecologic surgery for the treatment of pelvic organ prolapse in sacrospinous fixation surgery.



BF-1903
Sakrospinöz fiksasyon aleti
Sacrospinous fixation instruments
30 cm

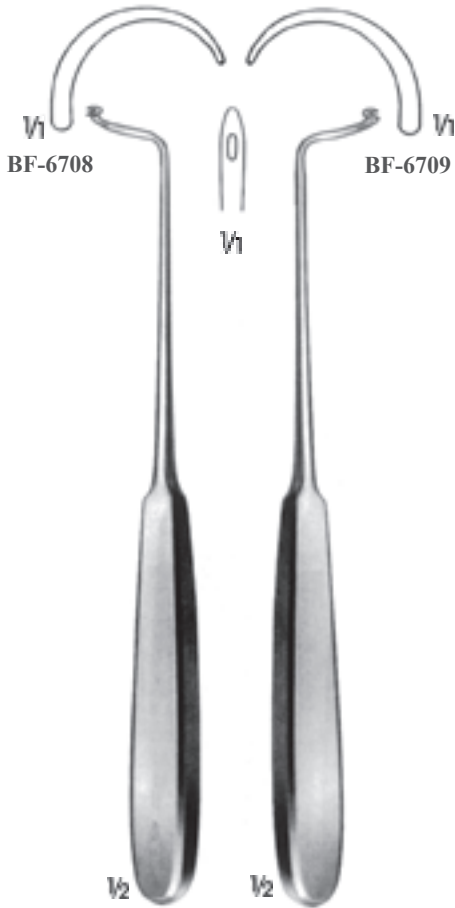

DESCHAMPS
BF-6708
Sağ el için, künt
For right hand blunt
BF-6709
Sol el için, künt
For left hand blunt
21 cm

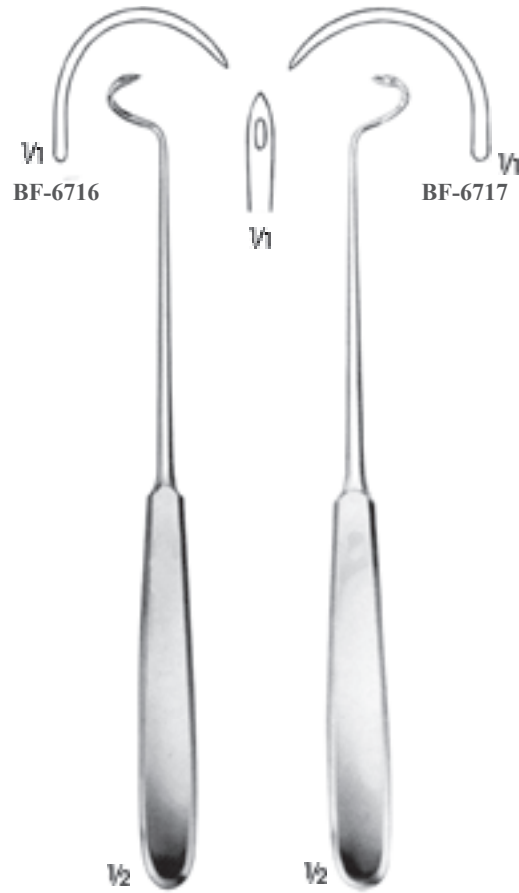

DESCHAMPS
BF-6716
Sağ el için, künt
For right hand blunt
BF-6717
Sol el için, künt
For left hand blunt
21.5 cm

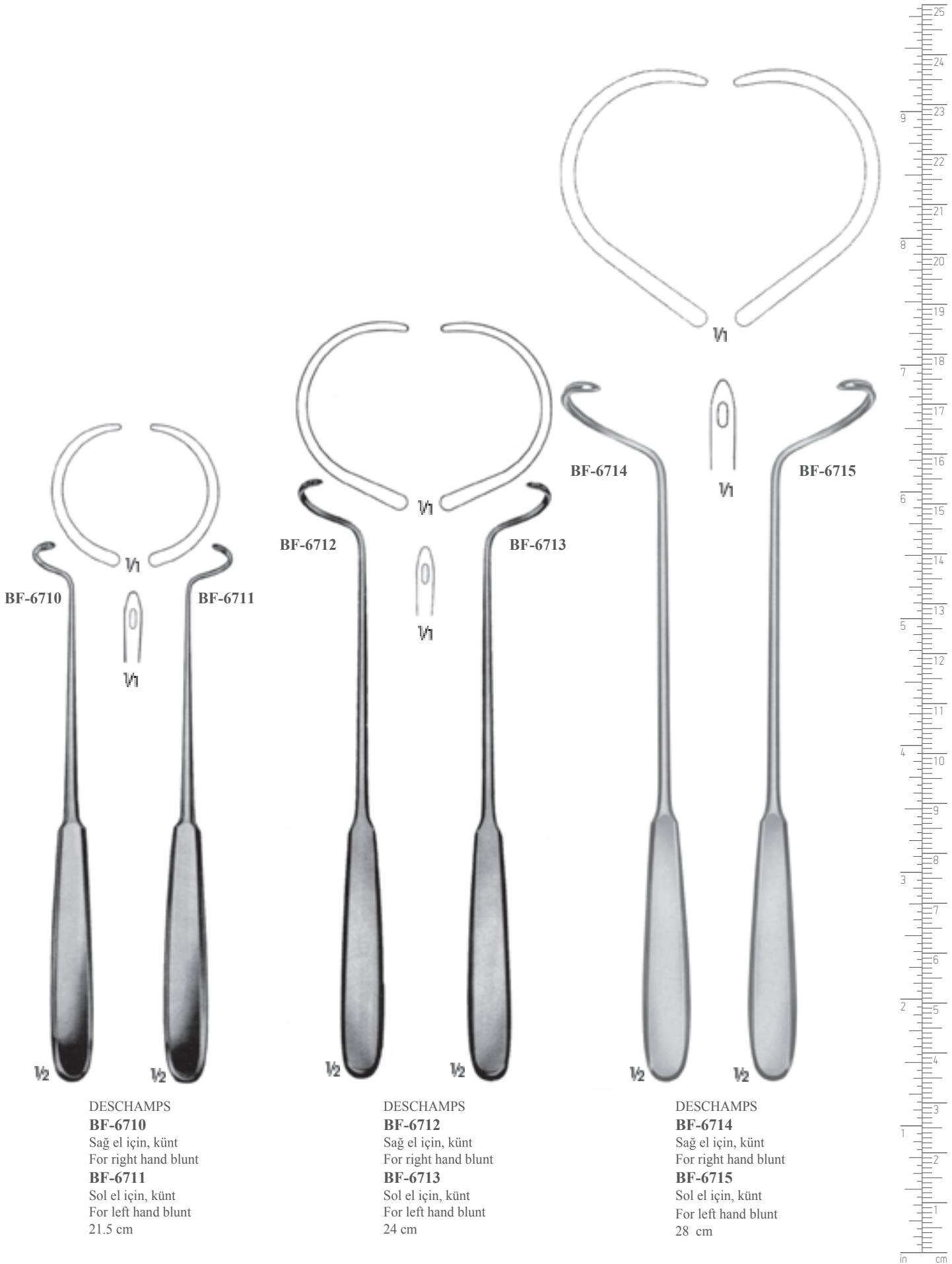

DESCHAMPS
BF-6710
Sağ el için, künt
For right hand blunt
BF-6711
Sol el için, künt
For left hand blunt
21.5 cm

DESCHAMPS
BF-6712
Sağ el için, künt
For right hand blunt
BF-6713
Sol el için, künt
For left hand blunt
24 cm

DESCHAMPS
BF-6714
Sağ el için, künt
For right hand blunt
BF-6715
Sol el için, künt
For left hand blunt
28 cm



BF-6802
15 cm



SYME
BF-6805
17 cm



JONESCO
BF-6804
Dikiş teli kılavuzu
Needle for wire suture
18.5 cm

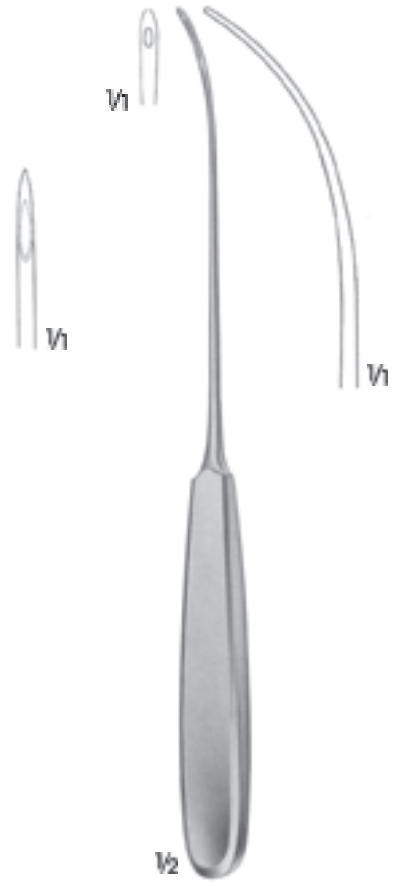

BF-6811
Bükülebilir/Malleable
23 cm



CLAUS VAN EICKEN
BF-6803
25 cm



COOPER
BF-6806
20.5 cm



KOCHER
BF-6807
20.5 cm



BRUNNER
BF-6812
24 cm





BF-6901



BF-6902



BF-7001



BF-7002

V2

BRUNNER
BF-6901 - BF-6902
Kılavuz sondaları/Guiding probes
30 cm

V2

BRUNNER
BF-7001 - BF-7002
Bağlama iğneleri/Ligature needles
30 cm

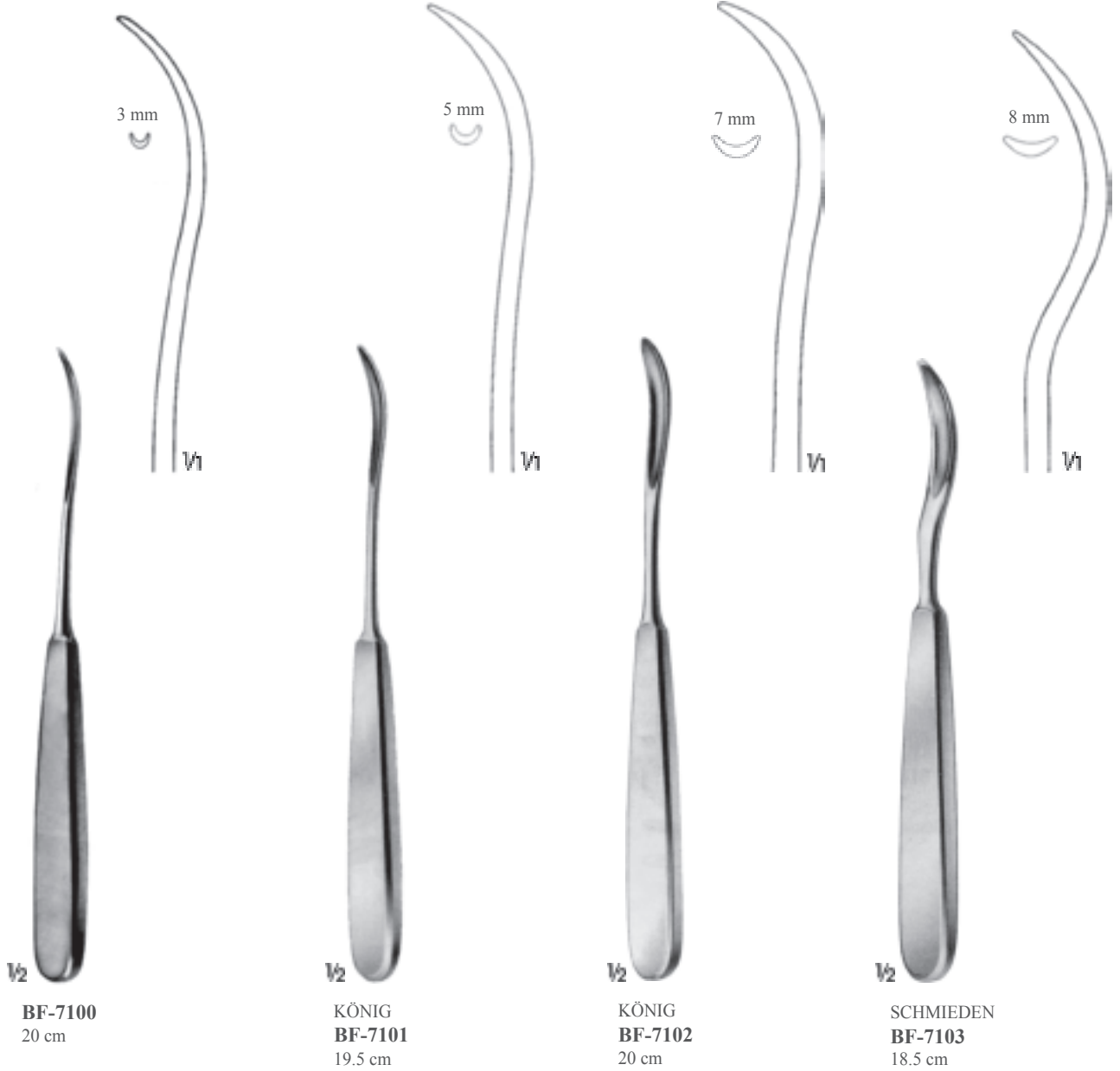



11 mm



1/2

KOCHER
BF-7106
15 cm



V1

12 mm



1/2

KOCHER
BF-7107
17 cm



V1

5 mm



1/2

PAYR
BF-7104
19.5 cm



V1

5 mm



1/2

PAYR
BF-7105
22.5 cm



V1

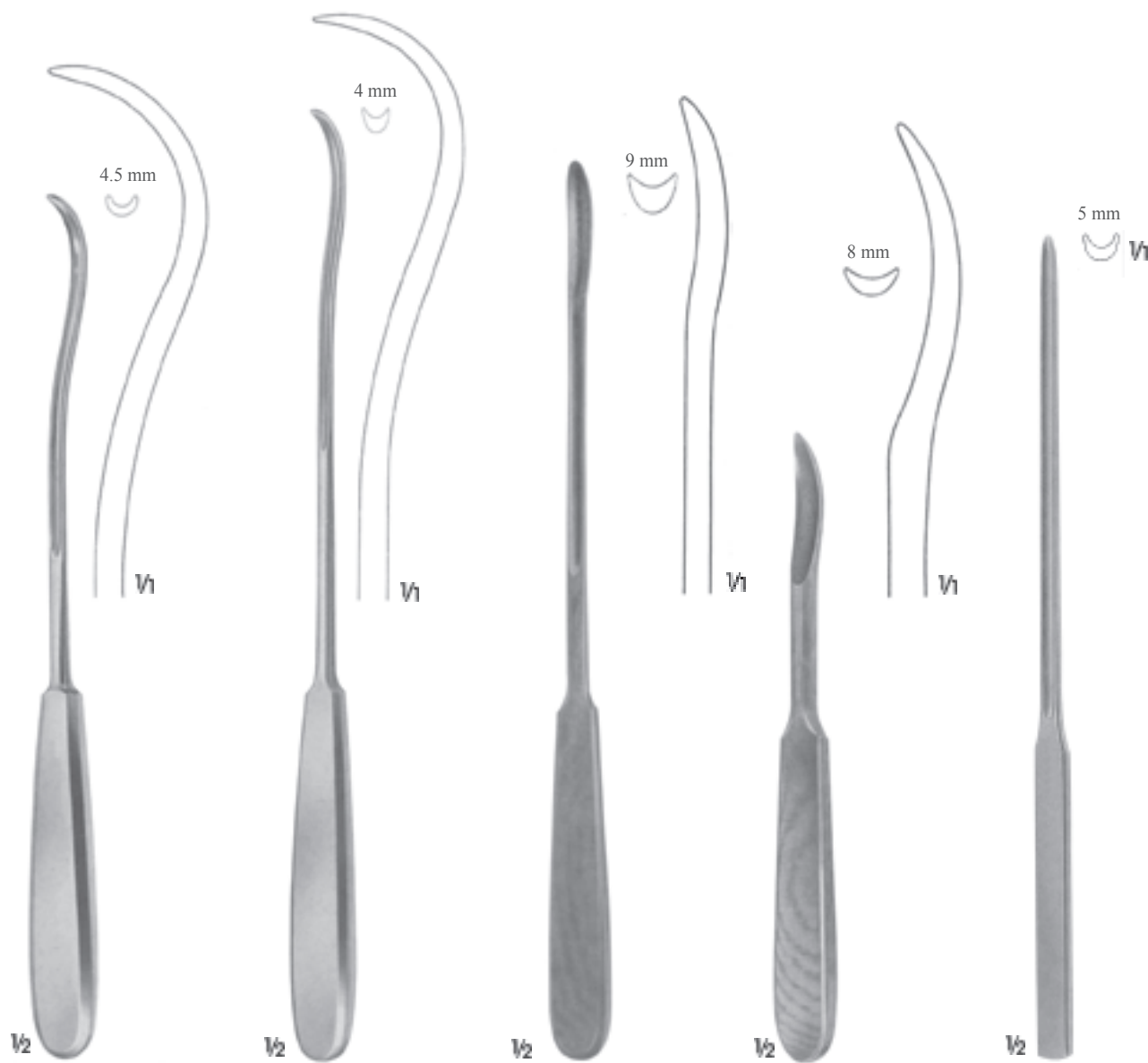

KIRSCHNER
BF-7108
25.5 cm

BF-7109
28 cm

BF-7111
Ağaç/Wooden
26.5 cm

BF-7110
Ağaç/Wooden
18.5 cm

BF-7112
Ağaç/Wooden
24 cm





1/2

**COLLIN
BF-7425**
Klip çıkarıcı pens
Clip removing forceps
13.5 cm



1/2

**HEATH
BF-7430**
Klip çıkarıcı pens
Clip removing forceps
13.5 cm



1/2

BV-1800
Düğüm aparatı
Attachment node
23 cm



1/4



1/2

**CASPAR
BV-1805**
Düğüm aparatı
Attachment node
23 cm



1/4



1/2

**HEGENBARTH
BF-7417**
Klip uygulayıcı penset
Clip applying forceps
12 cm



1/2

**MICHEL
BF-7420**
Klip uygulayıcı penset
Clip applying forceps
12.5 cm



1/2

**MICHEL
BF-7421**
Klip uygulayıcı ve çıkarıcı pens
Clip applying and removing forceps
12.5 cm



1/2

**MICHEL
BF-7422**
Klip Uygulayıcı ve çıkarıcı pens
Clip applying and removing forceps
13 cm





BF-7902
50 x 25 x 5 mm
BF-7903
50 x 30 x 6 mm
BF-7904
70 x 25 x 5 mm



BF-7900
60 x 25 x 11 mm
BF-7901
70 x 53 x 9 mm



BF-7905
150 x 90 x 10 mm



BF-7906
205 x 120 x 12 mm



1/2

BF-8010 65 x 16 mm İç kutu ve dış kutu takım/Needle case with interior box
BF-8012 95 x 16 mm İç kutu ve dış kutu takım/Needle case with interior box
BF-8014 65 x 16 mm BF-8010 için sadece dış kutu/Exterior box of BF-8010
BF-8011 62 x 17 mm BF-8010 için iç kutu/Interior box of BF-8010 only
BF-8013 90 x 17 mm BF-8012 için iç kutu/Interior box of BF-8012 only



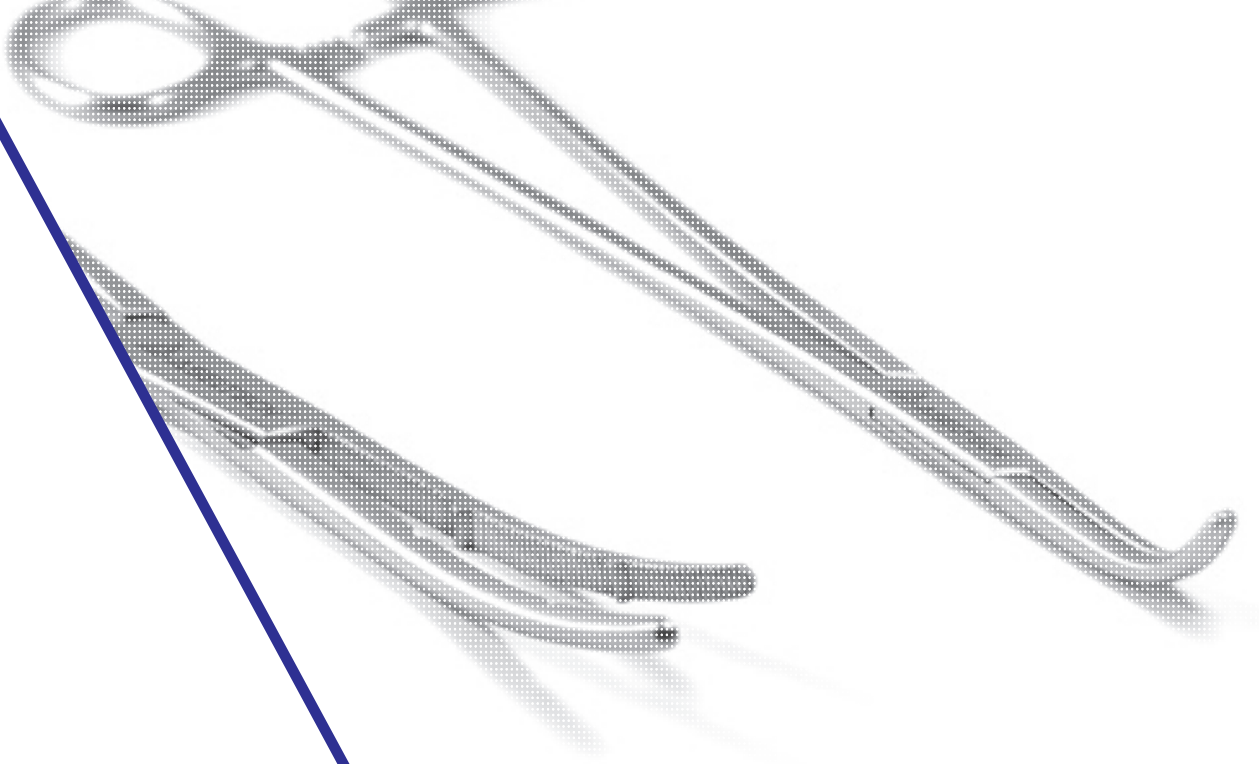

BG

Hemostatik Pensler, Diseksiyon Pensleri, Histerektomi Pensleri
Heamostatic Forceps, Dissecting Forceps, Hysterectomy Forceps





Geçici damar tıkama için:

Güvenli ve dikkatli şekilde damar kavrama

Sabitlenmiş baskı mesafeli, tırtıklı yüzeyli bleydler

Kapama kuvveti klipsin ağızlarının 1/3 mesafesinde 1 mm aralık durumunda ölçülür.

For temporary occlusion :

Safe and careful griping of vessel

Blades with serrated surface and rigidly fixed pressure feature

Closing force is measured at 1/3 of the blades a 1 mm opening



for vessel Ø 0.5 - 2.0 mm.

BT-1460 ve BT-1470 ile birlikte kullanılır.



for vessel Ø 0.5 - 2.0 mm.

BT-1450 ile birlikte kullanılır.

BIEMER

BT-1100

Çene uzunluğu/Length of jaws 6 mm

Açıklık/Opening 4 mm

Kapanma kuvveti/Closing force 30-40 gr. (0.29 - 0.39 N)

BT-1110

Çene Uzunluğu/Length of jaws 9 mm

Açıklık/Opening 5 mm

Kapanma kuvveti/Closing force 30-40 gr. (0.29 - 0.39 N)

BIEMER

BT-1120

Çene uzunluğu/Length of jaws 9 mm

Açıklık/Opening 5 mm

Kapanma kuvveti/Closing force 20-25 gr. (0.20 - 0.25 N)

MEHDORN

BT-1130

Çene uzunluğu/Length of jaws 1 mm

Açıklık/Opening 4 mm

Kapanma kuvveti/Closing force 10-15 gr. (0.10 - 0.15 N)

MEHDORN

BT-1140

Çene uzunluğu/Length of jaws 1.4 mm

Açıklık/Opening 4 mm

Kapanma kuvveti/Closing force 15-20 gr. (0.15 - 0.20 N)

MEHDORN

BT-1141

Çene uzunluğu/Length of jaws 1 mm

Açıklık/Opening 6 mm

Kapanma kuvveti/Closing force 10-15 gr. (0.10 - 0.15 N)

MEHDORN

BT-1142

Çene uzunluğu/Length of jaws 1.4 mm

Açıklık/Opening 6 mm

Kapanma kuvveti/Closing force 15-20 gr. (0.15 - 0.20 N)

Mikro damar anastomileri için:
Güvenli ve dikkatli şekilde damar kavrama.
Sabitlenmiş baskı mesafeli, tırtıllı yüzeyli bleydler.
Klipsler arası mesafe ayarlanabilir.
Bükerek otomatik sabitleme.

For micro vessel anastomosis:
Safe and careful gripping of vessel.
Blades with serrated surface and rigidly fixed pressure feature.
Adjustable distance between clips.
Automatic fixation by tilling



BIEMER-MULLER
BT-1150
Çene uzunluğu/Length of jaws.6 mm
Açıklık/Opening 4 mm
Kapanma kuvveti/Closing force 30-40 gr.



BIEMER-MÜLLER
BT-1160
Çene uzunluğu/Length of jaws.4.5 mm
Açıklık/Opening 3 mm
Kapanma kuvveti/Closing force 25-30 gr.



BIEMER-MÜLLER
BT-1170
Çene uzunluğu/Length of jaws.9 mm
Açıklık/Opening 5 mm
Kapanma kuvveti/Closing force 25-30 gr.



BIEMER-MÜLLER
BT-1180
Çene uzunluğu/Length of jaws.9 mm
Açıklık/Opening 5 mm
Kapanma kuvveti/Closing force 25-30 gr.



BIEMER-MÜLLER
BT-1190
Çene uzunluğu/Length of jaws.9 mm
Açıklık/Opening 5 mm
Kapanma kuvveti/Closing force 25-30 gr.



BIEMER-MÜLLER
BT-1195
Çene uzunluğu/Length of jaws.9 mm
Açıklık/Opening 5 mm
Kapanma kuvveti/Closing force 25-30 gr.

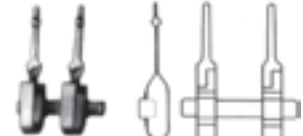

MÜLLER
BT-1200
Kapanma kuvveti/Closing force. 25-30 gr.

Ø 1 mm

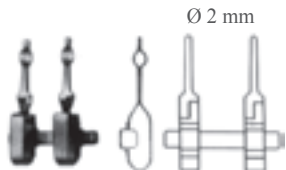

MÜLLER
BT-1210
Kapanma kuvveti/Closing force. 25-30 gr.

Ø 2 mm

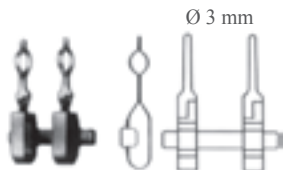

MÜLLER
BT-1220
Kapanma kuvveti/Closing force. 25-30 gr.

Ø 3 mm

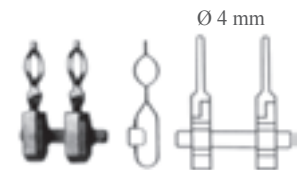

MÜLLER
BT-1230
Kapanma kuvveti/Closing force. 25-30 gr.

Ø 4 mm





BIEMER
BT-1470

Kilitsiz/Without lock



BIEMER
BT-1460

Kilitli/With lock



W1



W1

BIEMER
BT-1310

Uygulama pensetleri, damar klipsleri,
BIEMER-MÜLLER ve MÜLLER aproksi
matör.
Applying forceps for BIEMER
vessel approximator
14.5 cm



W1

BIEMER
BT-1151
Komple/Complete
BT-1150
Sadece aproksimatör
Approximator only
BT-1310 Klip penset
Applying Forceps



W1

MEHDORN
BT-1450

Uygulama pensetleri, MEHDORN
damar klipsleri
Applying forceps for MEHDORN
vessel clips
15 cm

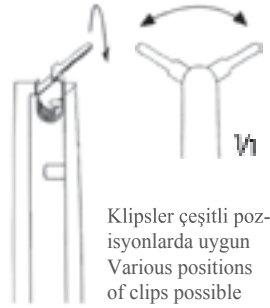

Klipsler çeşitli poz-
isyonlarda uygun
Various positions
of clips possible

BIEMER
BT-1460 - BT-1470
BIEMER damar klipleri ve BIEMER-MÜLLER ve
MÜLLER yaklaşıtrıcılar için başvuru pensleri
Applying forceps for BIEMER vessel clips and
BIEMER-MÜLLER and MÜLLER approximators
14 cm



BIEMER
BT-1320
Komple Aproksimatör,
anahtarı ile (BT-1340)
Approximator, complete
with key (BT-1340)

Derin aralıkta mikro damar anastomileri için.

- Güvenli ve dikkatli şekilde damar kavrama.
- Tırtıklı yüzeyli bleydler.
- Anahtar ile (BT-1340) basınç ayarı.
- Anahtar ile (BT-1340) klipsler arası mesafenin ayarlanması ve sabitlenmesi.

For micro vessel anastomosis

- Safe and careful gripping of vessel.
- Blades with serrated blade surface
- Pressure adjustment with use of key (BT-1340)
- Adjustment of distance between blades and fixation of blades with a use of key (BT-1340)



BIEMER
BT-1330
Komple Aproksimatör,
anahtarı ile (BT-1340)
Approximator, complete
with key (BT-1340)

Sinir anostomilerine güvenli adaptasyon

- Sinir merkezinin, güçlü patolojik değişiklikleri önleyen hassas iğneler ile delinmesi
- Anahtar (BT-1340) kullanımı ile değiştirilebilir iğneler.
- Anahtar ile iğneler arası mesafenin ayarlanması ve sabitlenmesi

Safe adaptation of nerve anastomoses

- Piercing the nerve center with fine needles that prevents strong pathological changes
- Changeable needles with use of key. (BT-1340)
- Adjustment of distance between needles and fixation of needles with use of key (BT-1340)



BT-1400
Approximator

Derin aralıkta mikro damar anastomileri için.

- Güvenli ve dikkatli şekilde damar kavrama.
- Tırtıklı yüzeyli bleydler.
- El ile basınç ayarı yapabilme özelliği.
- Mesafeyi el ile yakınlaştırma ve uzaklaştırma.

For micro vessel anastomosis

- Safe and careful gripping of vessel.
- Blades with serrated blade surface.
- The ability to manually set the pressure.
- Distance, zoom in and out manually.



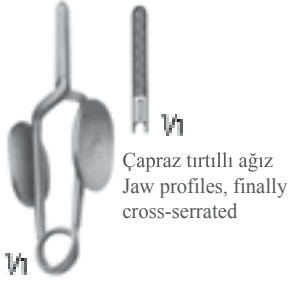

Çapraz tırtıllı ağız
Jaw profiles, finally
cross-serrated

MÜLLER
BG-1200
Dikiş pensisi
Ligature forceps

Travmatik olmayan damar klipleri, Geçici Non-traumatic Vessel Clips, temporary



MÜLLER
BG-1201
Kapama kuvveti 50 gr/Düz
Closing Forceps 50 gr /Straight
BG-1206
Kapama kuvveti 80 gr/Düz
Closing forceps 80 gr/Straight



MÜLLER
BG-1202
Kapama kuvveti 50 gr/Eğri
Closing forceps 50 gr/Curved
BG-1207
Kapama kuvveti 80 gr/Eğri
Closing forceps 80 gr/Curved



MÜLLER
BG-1203
Kapama kuvveti 50 gr/Eğri
Closing forceps 50 gr/Curved
BG-1208
Kapama kuvveti 80 gr/Eğri
Closing forceps 80 gr/Curved



MÜLLER
BG-1204
Kapama kuvveti 50 gr/Yana doğru açılı
Closing forceps 50 gr/Angled to side
BG-1209
Kapama kuvveti 80 gr/Yana doğru açılı
Closing forceps 80 gr/Angled to side



MÜLLER
BG-1205
Kapama kuvveti 50 gr/Diz bükümlü
Closing Forceps 50 gr/Knee-bent
BG-1210
Kapama kuvveti 80 gr/Diz bükümlü
Closing Forceps 80 gr/Knee-bent

Özellikler :

- Atromatik ağız profili.
- Her iki tarafta kullanılan tutma plakaları kliplerin güvenli bir şekilde uygulanması ve çıkarılmasına yardımcı olur.
- Atar ve toplar damarlar için kesin olarak tanımlanmış kapama basınçları.
- Damar klemplerinin üzerine kapanma basınçları markalanmıştır.

Features :

- Atraumatic mouth profile.
- Holding plates used on both side of the clips ensure safe application and removal.
- Closing pressure of the clips are exactly defined for arterial and venous vessels.
- Closing pressure of the clips is marked on the clips.

De Baakey Diş



Toothing De Baakey



1/2

MÜLLER
BH-1200

Kapama kuvveti/Closing force 250 gr

BH-1201

Kapama kuvveti/Closing force 350 gr

Düz/Straight



1/2

MÜLLER
BH-1202

Kapama kuvveti/Closing force 250 gr

BH-1203

Kapama Kuvveti/Closing force 350 gr

Eğri/Curved



1/2

MÜLLER
BH-1204

Kapama kuvveti/Closing force 250 gr

BH-1205

Kapama kuvveti/Closing force 350 gr

Eğri/Curved



1/2

MÜLLER
BH-1206

Kapama kuvveti/Closing force 250 gr

BH-1207

Kapama Kuvveti/Closing Force 350 gr

Diz bükümlü/Knee-bent





	Toplam boy Total length	Ağız uzunluğu Length of jaws
DE BAKEY-HESS BG-1360	34 mm	20mm
BG-1365	43 mm	30mm



	Toplam boy Total length	Ağız uzunluğu Length of jaws
JOHNS-HOPKINS BG-1312	38 mm	12 mm
BG-1317	48 mm	17 mm
BG-1325	56 mm	25 mm
BG-1330	63 mm	30 mm
BG-1333	70 mm	33 mm
BG-1342	80 mm	42 mm
BG-1352	91 mm	52 mm



JOHNS-HOPKINS
BG-1355
Bulldog klemplerin takılması ve çıkarılması için pens
BG-1301 - BG-1365 ve
BH-1325 - BH-1458
Forceps for applying and removing bulldog clamps
BG-1301 - BG-1365 and BH-1325 - BH-1458
24 cm



	Toplam boy Total length	Ağız uzunluğu Length of jaws
DIEFFENBACH BG-1301	38 mm	12 mm
BG-1302	48 mm	16 mm



	Toplam boy Total length	Ağız uzunluğu Length of jaws
DIEFFENBACH BG-1303	38 mm	12 mm
BG-1304	48 mm	16 mm



	Toplam boy Total length	Ağız uzunluğu Length of jaws
DIEFFENBACH BG-1305	58 mm	16 mm



	Toplam boy Total length	Ağız uzunluğu Length of jaws
DIEFFENBACH BG-1306	58 mm	16 mm

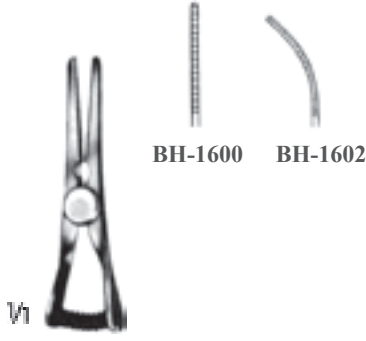

BH-1600 - BH-1602
Ağız uzunluğu 14 mm
Length of jaws 14 mm
35 mm



BH-1601
Ağız uzunluğu 19 mm
Length of jaws 19 mm
45 mm



BH-1603
Ağız uzunluğu 19 mm
Length of jaws 19 mm
45 mm



**DIETRICH
BG-1100**
Ağız uzunluğu 13 mm
Length of jaws 13 mm
55 mm



**DIETRICH
BG-1106**
Ağız uzunluğu 10 mm
Length of jaws 10 mm
48 mm



**DIETRICH
BG-1107**
Ağız uzunluğu 13 mm
Length of jaws 13 mm
48 mm





De Bakey Diş



Toothing De Bakey

Kapanma kuvveti 180 gr.
Closing force 180 gr.



BH-1100

Ağız uzunluğu 10 mm
Length of jaws 10 mm
Düz/Straight
5 cm



BH-1101

Ağız uzunluğu 14 mm
Length of jaws 14 mm
Düz/Straight
5.5 cm



BH-1102

Ağız uzunluğu 20 mm
Length of jaws 20 mm
Düz/Straight
6 cm



BH-1103

Ağız uzunluğu 20 mm
Length of jaws 20 mm
Eğri/Curved
5.5 cm



55°

BH-1104

Ağız uzunluğu 10 mm
Length of jaws 10 mm
Açılı/Angled
5 cm



55°

BH-1105

Ağız uzunluğu 14 mm
Length of jaws 14 mm
Açılı/Angled
5 cm



55°

BH-1106

Ağız uzunluğu 20 mm
Length of jaws 20 mm
Açılı/Angled
5.5 cm

De Bakey Diş



Toothing De Bakey



DE BAKEY
BH-1827
Ağız uzunluğu 27 mm
Length of jaws 27 mm
4.8 cm



DE BAKEY
BH-1938
Ağız uzunluğu 38 mm
Length of jaws 38 mm
7.3 cm



DE BAKEY
BH-1963
Ağız uzunluğu 63 mm
Length of jaws 63 mm
9.9 cm

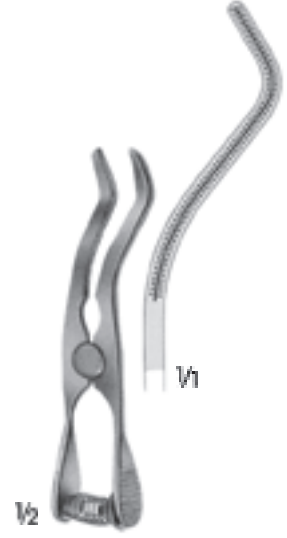

DE BAKEY
BH-1954
Ağız uzunluğu 54 mm
Length of jaws 54 mm
9.5 cm



DE BAKEY
BH-1615
Ağız uzunluğu 27 mm
Length of jaws 27 mm
5 cm



GLOVER
BH-1610
Ağız uzunluğu 35 mm
Length of jaws 35 mm
5.2 cm



	Toplam boy Total length	Ağız uzunluğu Length of jaws
GLOVER BH-1733	6.8 cm	33 mm
BH-1750	9.6 cm	50 mm
BH-1769	11.7 cm	69 mm



	Toplam boy Total length	Ağız uzunluğu Length of jaws
GLOVER BH-1833	6.5 cm	33 mm
BH-1850	9.1 cm	50 mm
BH-1869	11 cm	69 mm



	Toplam boy Total length	Ağız uzunluğu Length of jaws
DE BAKEY BH-1325	8.0 cm	25 mm
BH-1335	9.0 cm	35 mm
BH-1350	10.5 cm	50 mm
BH-1368	12.4 cm	68 mm



	Toplam boy Total length	Ağız uzunluğu Length of jaws
DE BAKEY BH-1423	7.8 cm	23 mm
BH-1431	8.6 cm	31 mm
BH-1442	9.7 cm	42 mm
BH-1458	11.4 cm	58 mm



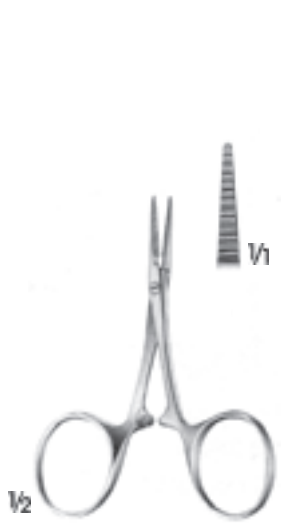

CARREL
BG-4205
8.5 cm

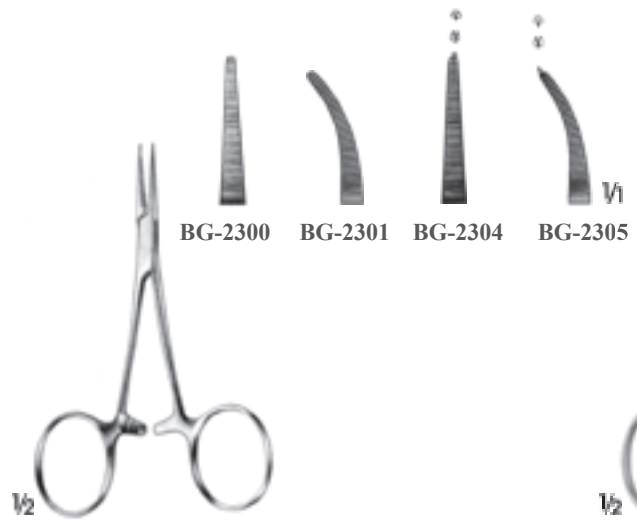

BABY-MOSQUITO
(HARTMANN)
BG-2300 - BG-2305
10 cm

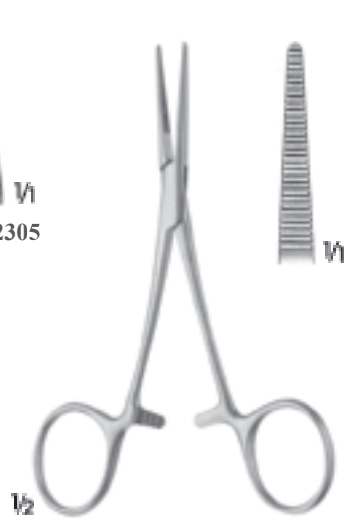

DUNHILL
BG-2310
12.5 cm

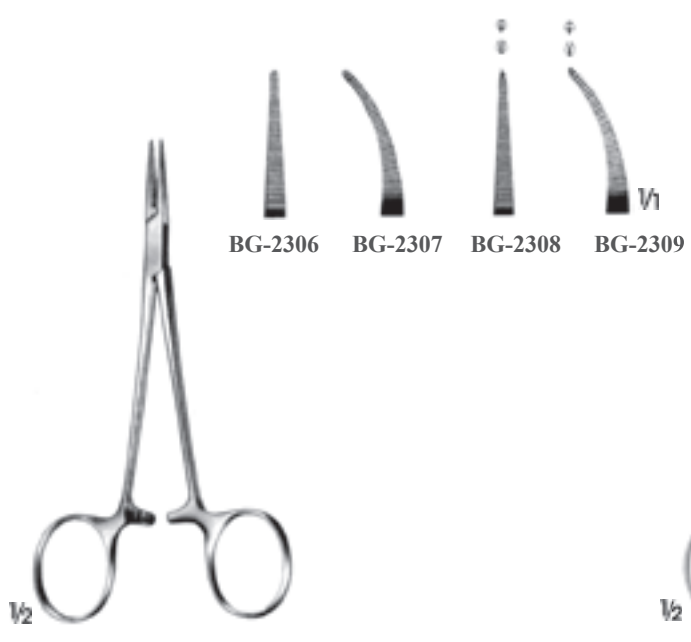

MICRO-HALSTED
BG-2306 - BG-2309
12.5 cm

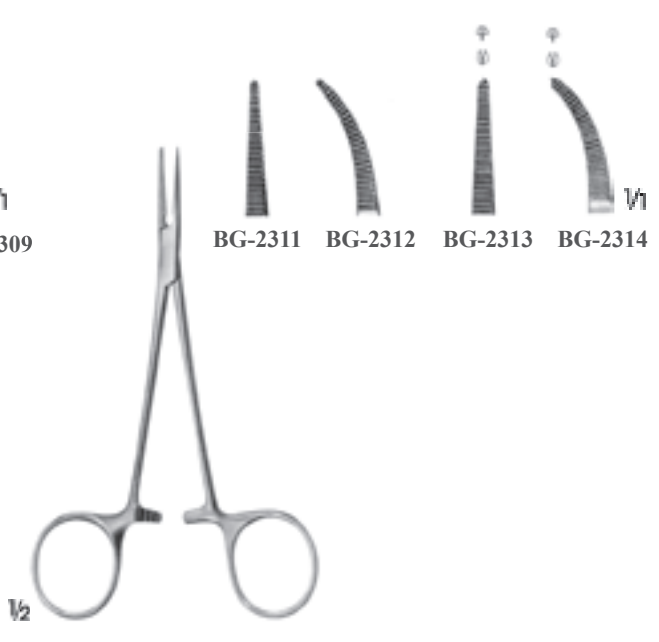

HALSTED-MOSQUITO
BG-2311 - BG-2314
12.5 cm



BABY-CRILE
BG-2315 - BG-2318
14 cm

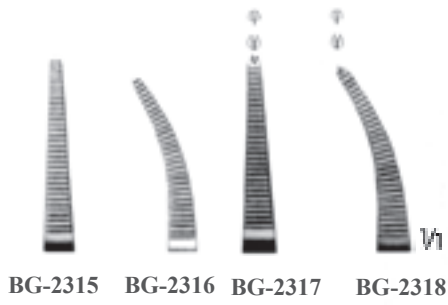

CAIRNS
BG-2319 - BG-2320
15 cm

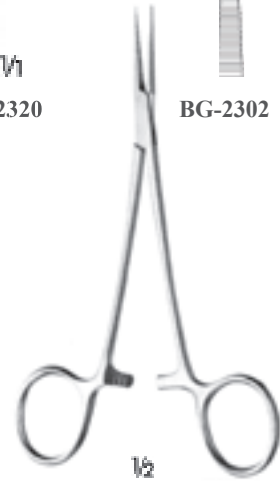
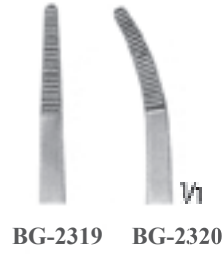

JACOBSON
BG-2302 - BG-2303
12.5 cm

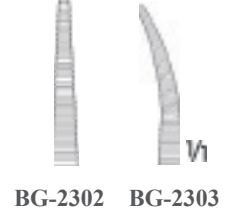

PROVIDENCE-HOSPITAL
BG-2321 - BG-2322
14 cm



KELLY
BG-2324 - BG-2325
14 cm

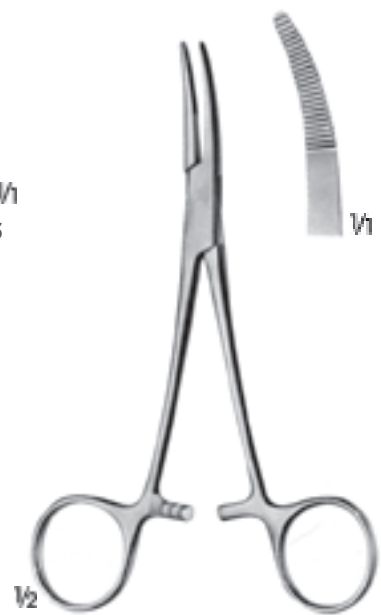

MOYNIHAN
BG-2323
Yana eğimli/Curved to side
15 cm





V2

CAIRNS
BG-2326
Yana eğimli/Curved to side
14.5 cm



V1



V2

DANDY
BG-2327 - BG-2328
Yana eğimli/Curved to side
14 cm

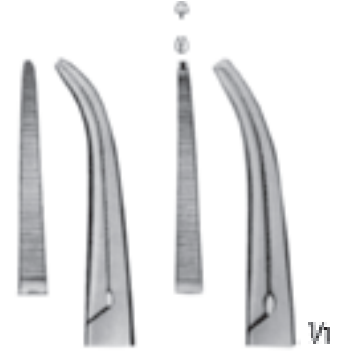

BG-2327

BG-2328



V2

CRILE
BG-2329 - BG-2332
14 cm

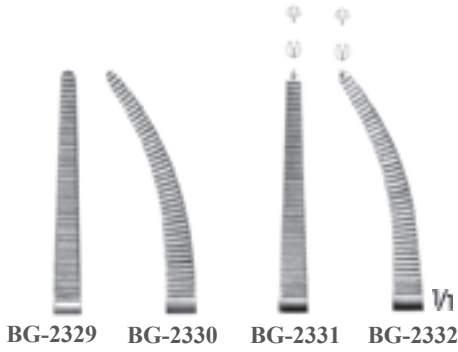

BG-2329

BG-2330

BG-2331

BG-2332

V1

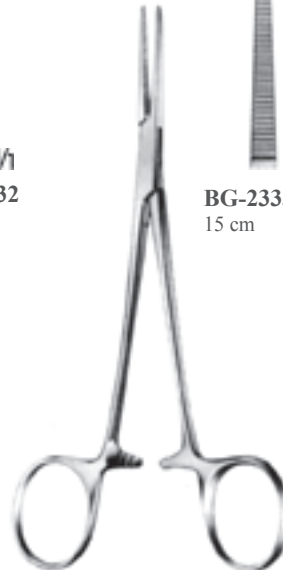

LERICHE
BG-2333 - BG-2336

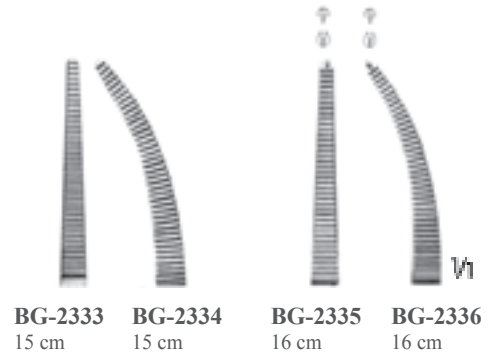

BG-2333
15 cm

BG-2334
15 cm

BG-2335
16 cm

BG-2336
16 cm

V1

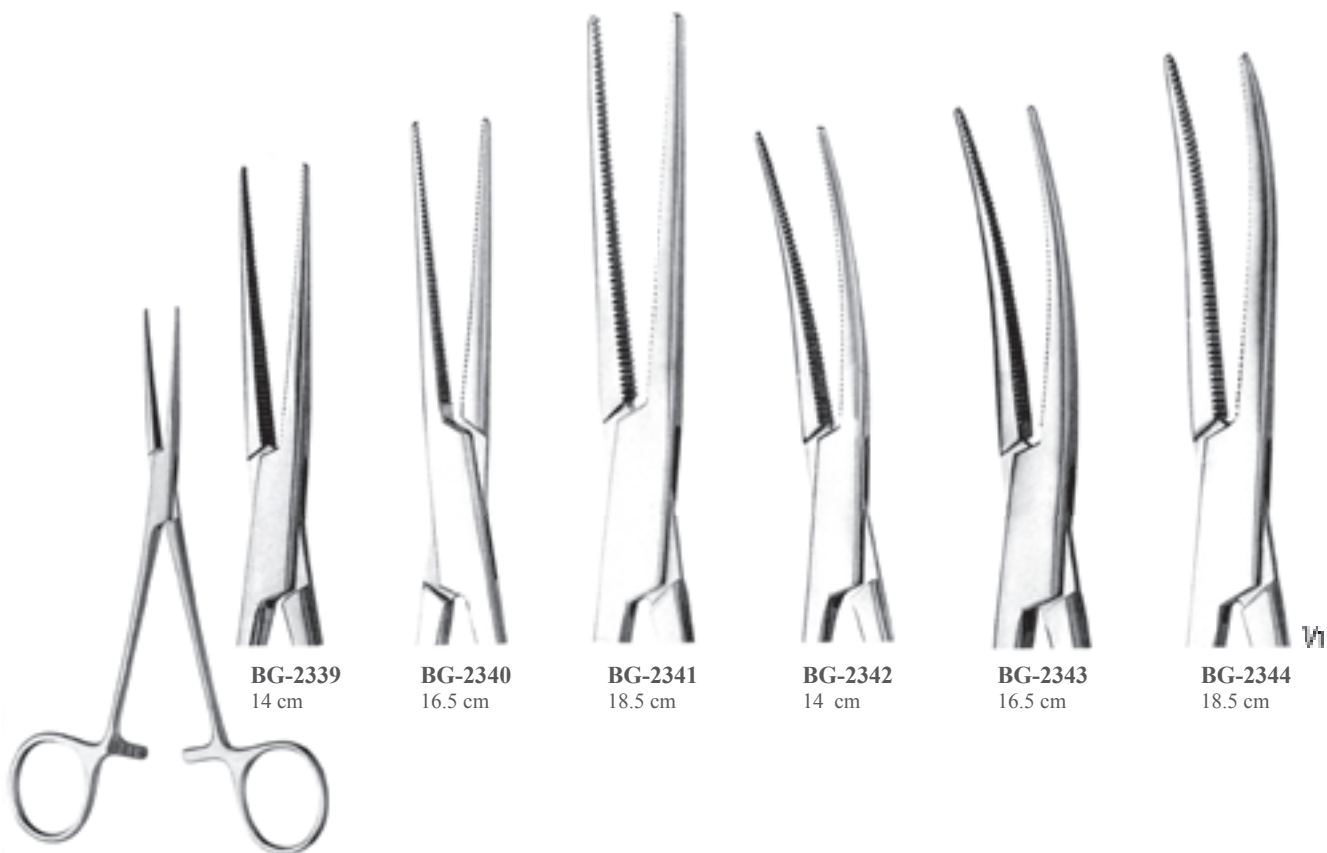

BG-2339
14 cm

BG-2340
16.5 cm

BG-2341
18.5 cm

BG-2342
14 cm

BG-2343
16.5 cm

BG-2344
18.5 cm

COLLER
BG-2339 - BG-2344

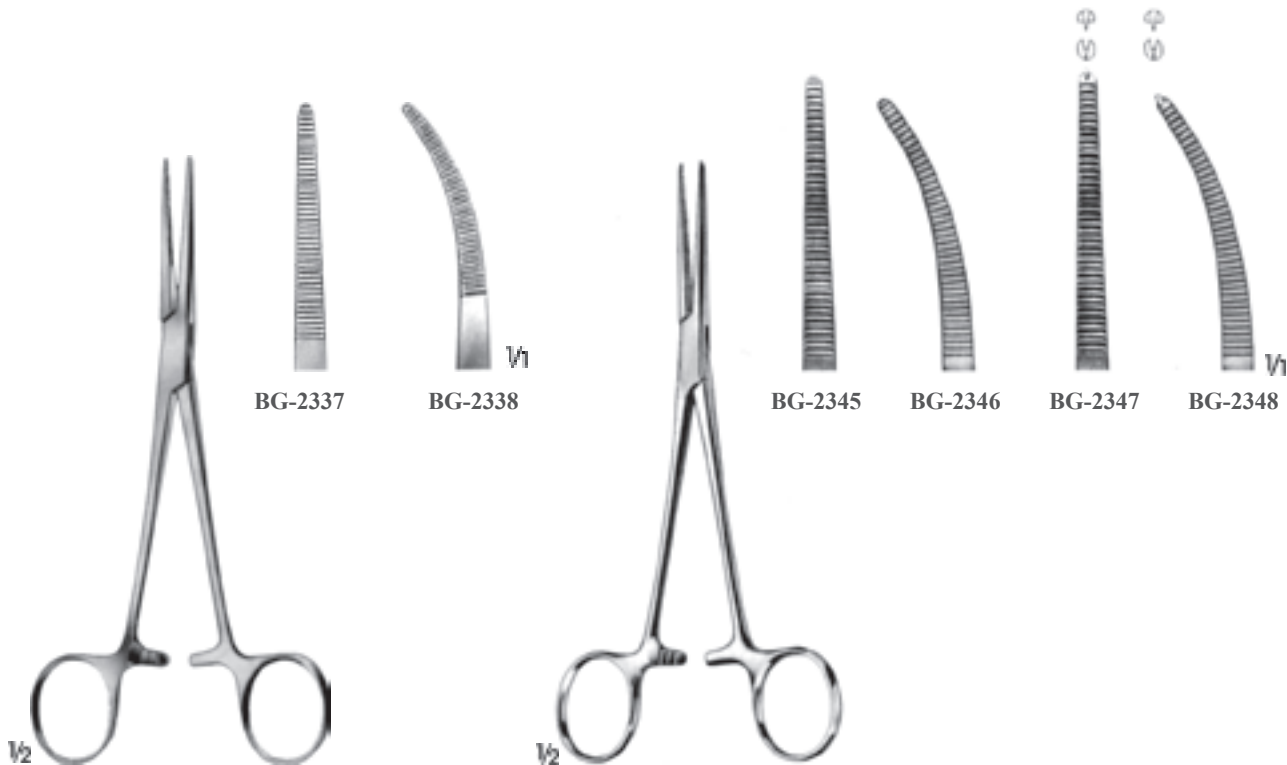

BG-2337

BG-2338

BG-2345

BG-2346

BG-2347

BG-2348

RANKIN
BG-2337 - BG-2338
16 cm

CRILE
BG-2345 - BG-2348
16 cm



DIXON-LOVELACE
BG-2349 - BG-2350
16 cm



FUCHSIG
BG-2352
19.5 cm



NISSEN
BG-2353
18.5 cm

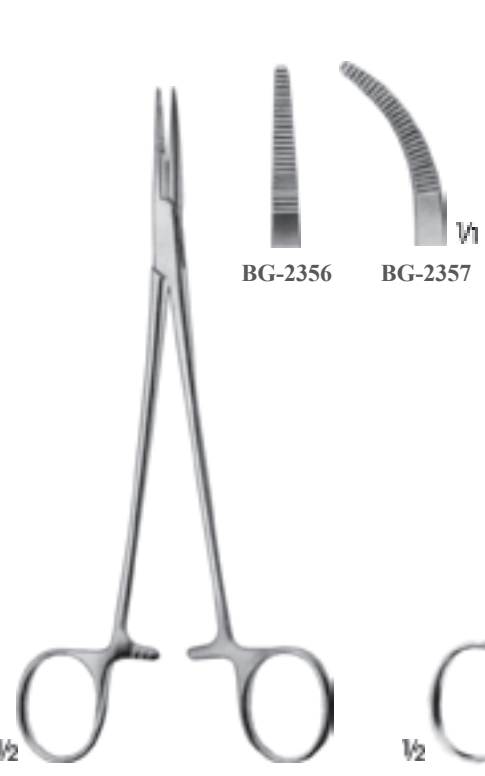

ADSON
BG-2356 - BG-2357
18.5 cm

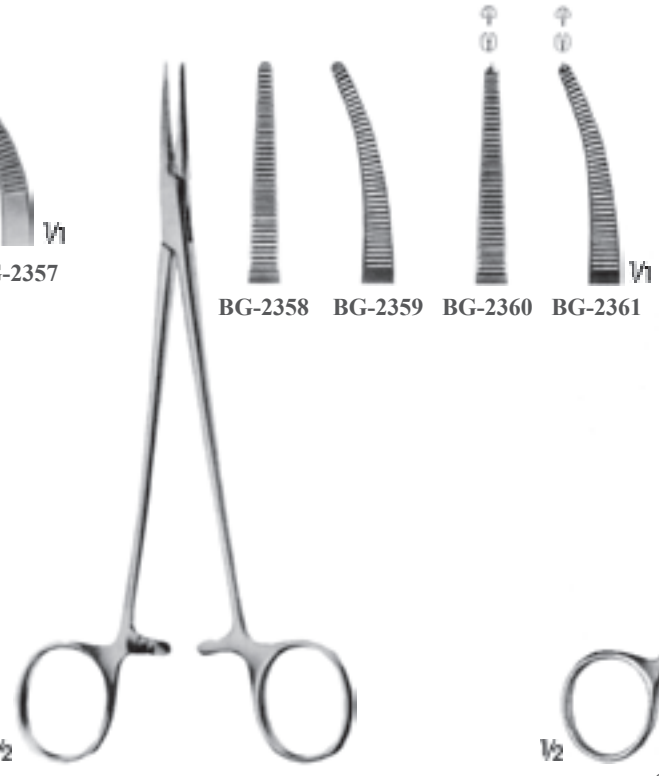

HALSTED
BG-2358 - BG-2361
18.5 cm

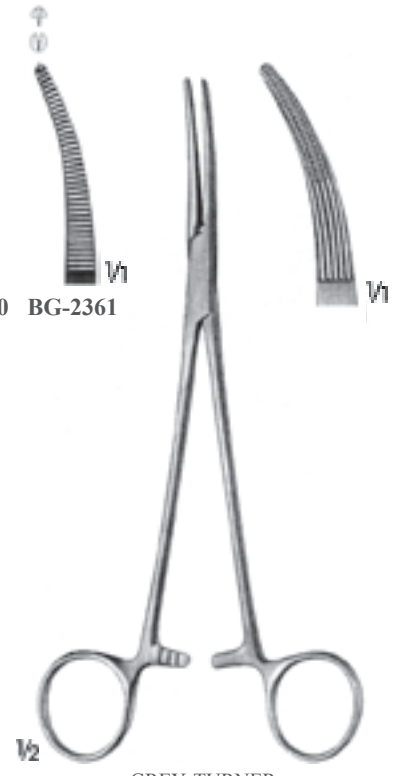

GREY-TURNER
BG-2362
18 cm

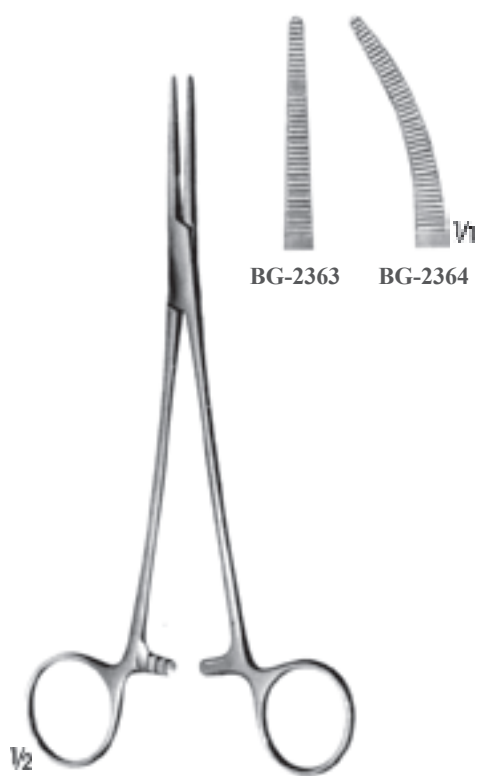

BIRKETT
BG-2363 - BG-2364
18.5 cm

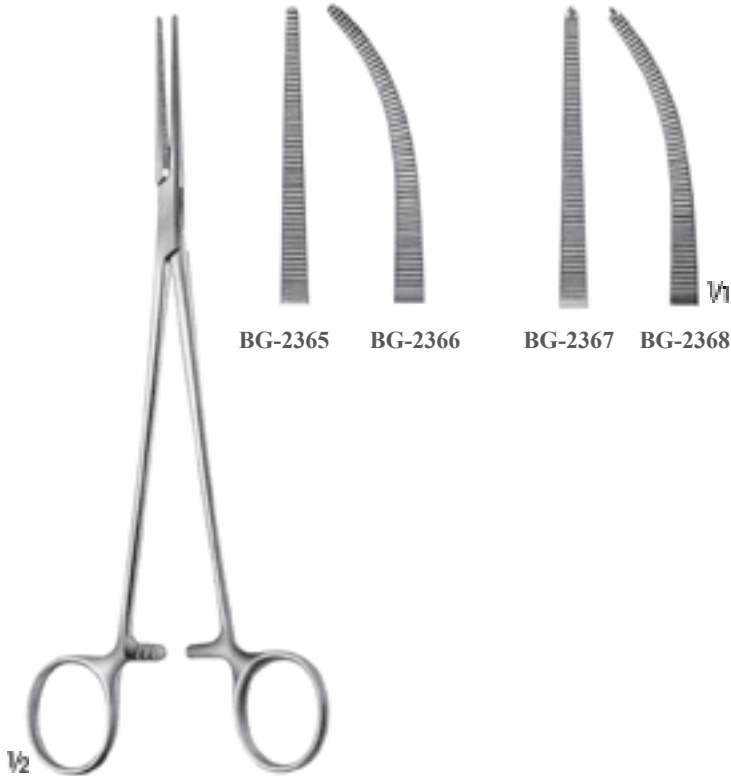

HALSTED-MOSQUITUO
BG-2365 - BG-2368
20 cm



FRASER-KELLY (CRILE)
BG-2354
18 cm



DUNHILL
BG-2355
19 cm



JACOBSON
BG-2351
19 cm



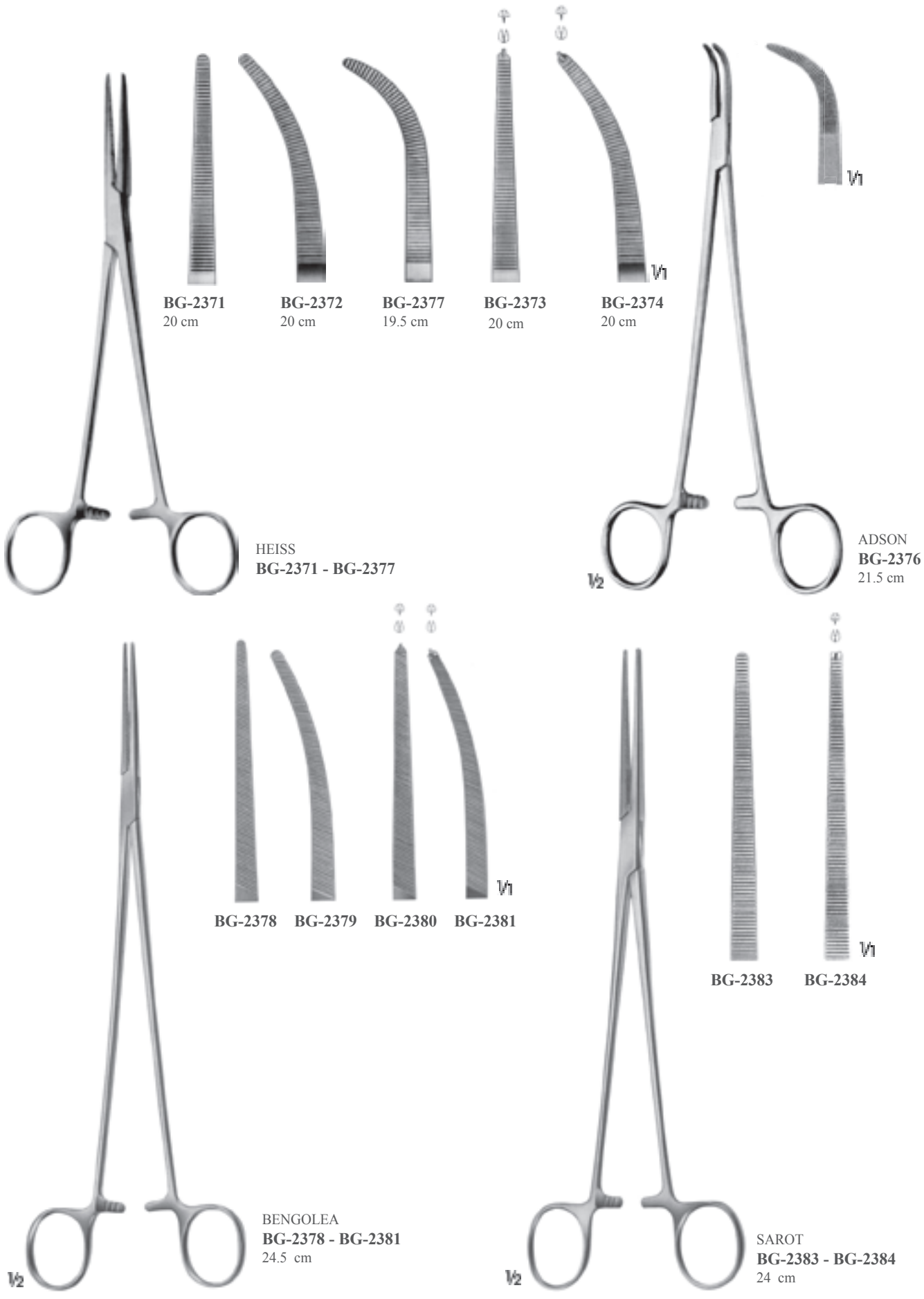



CRAFOORD
BG-2385
24.5 cm



CRAFOORD,MOD.
BG-2386
24 cm

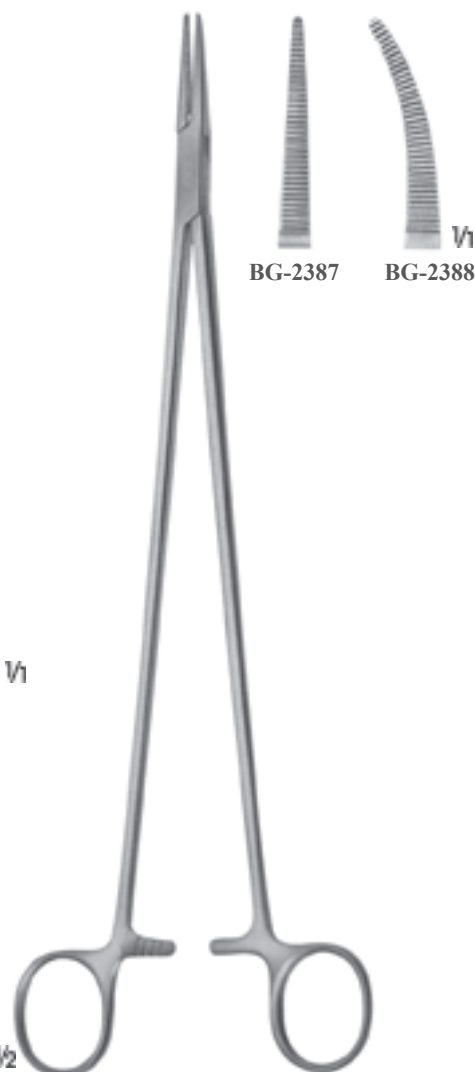

BRIDGE
BG-2387 - BG-2388
27.5 cm



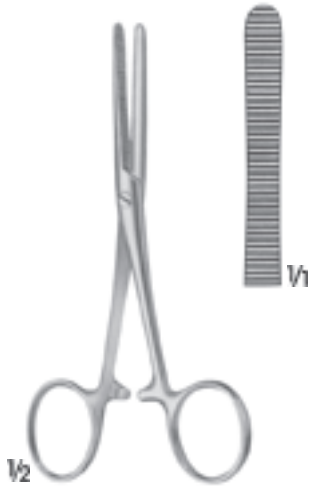

PEAN
BG-2433
12.5 cm



KRÖNLEIN
BG-2434
13 cm



PEAN
BG-2500
12.5 cm



BG-2501
12.5 cm

BG-2502
14 cm

PEAN
BG-2501 - BG-2502

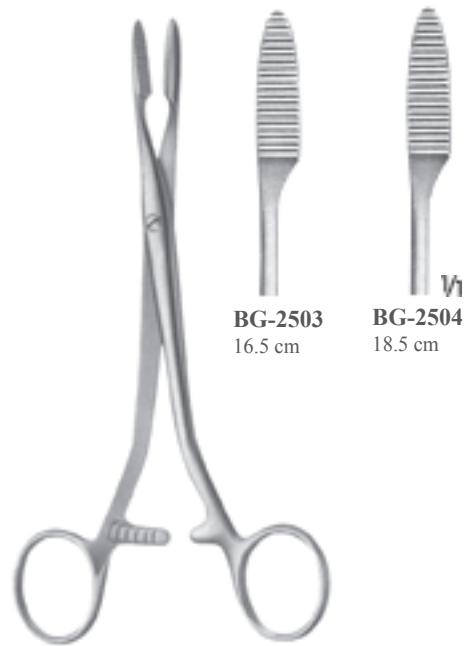

BG-2503
16.5 cm

BG-2504
18.5 cm

PEAN
BG-2503 - BG-2504





BG-2506
13 cm



BG-2507
14 cm



BG-2508
13 cm



BG-2509
14 cm

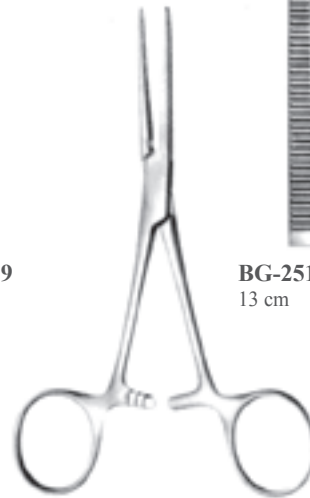

BG-2510
13 cm



BG-2511
14 cm



BG-2512
14 cm

PEAN
BG-2506 - BG-2509
Ince model/Slender type

PEAN
BG-2510 - BG-2512



BG-2613
13 cm



BG-2615
15 cm



BG-2617
17.5 cm



BG-2620
20 cm



BG-2713
13 cm



BG-2715
15 cm



BG-2717
17.5 cm



BG-2720
20 cm



BG-2723
23 cm

SPENCER - WELLS
BG-2613 - BG-2723



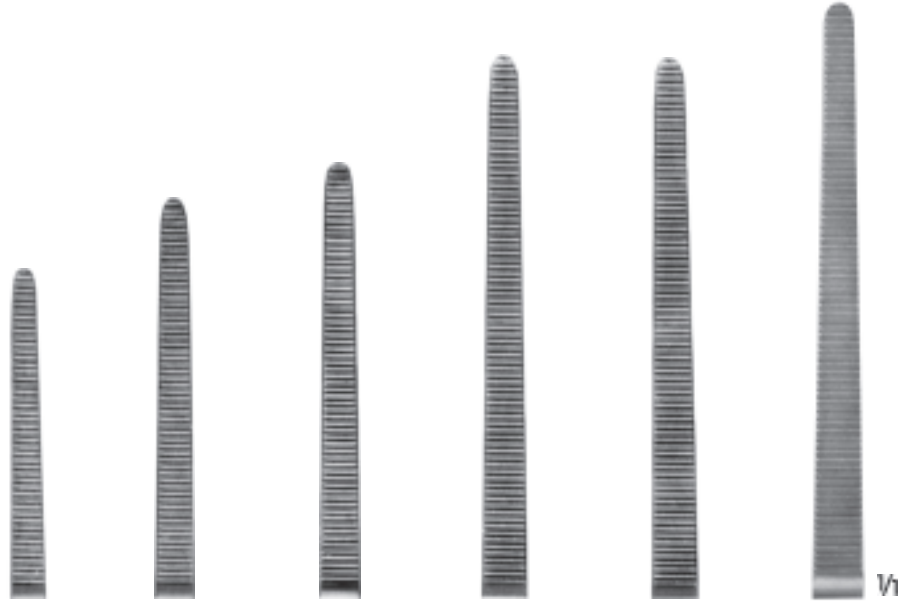

BG-2816 16 cm **BG-2818** 18.5 cm **BG-2820** 20 cm **BG-2822** 22.5 cm **BG-2824** 24 cm **BG-2835** 35 cm



BG-2916 16 cm **BG-2918** 18.5 cm **BG-2920** 20 cm **BG-2922** 22.5 cm **BG-2924** 24 cm **BG-2935** 35 cm



ROCHESTER - PEAN
BG-2816 - BG-2935



PEAN
BG-3024 - BG-3128

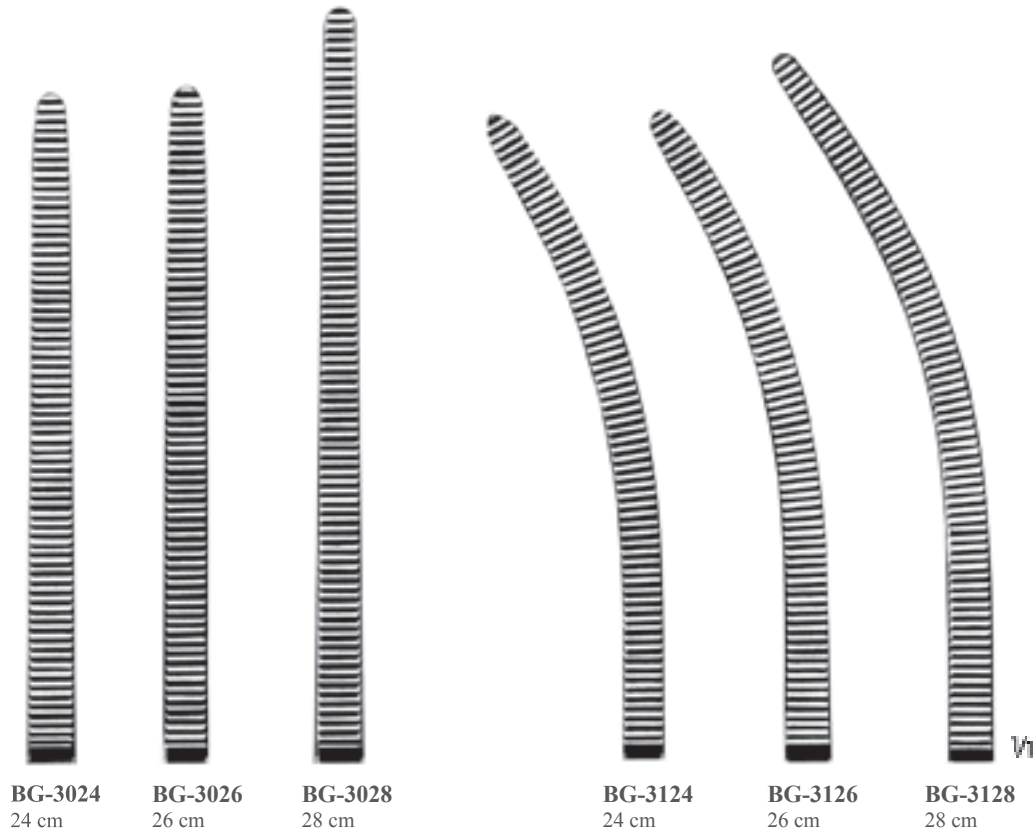

BG-3024
24 cm

BG-3026
26 cm

BG-3028
28 cm

BG-3124
24 cm

BG-3126
26 cm

BG-3128
28 cm





KOCHER
BG-3200
Güçlü model/Strong pattern
14.5 cm

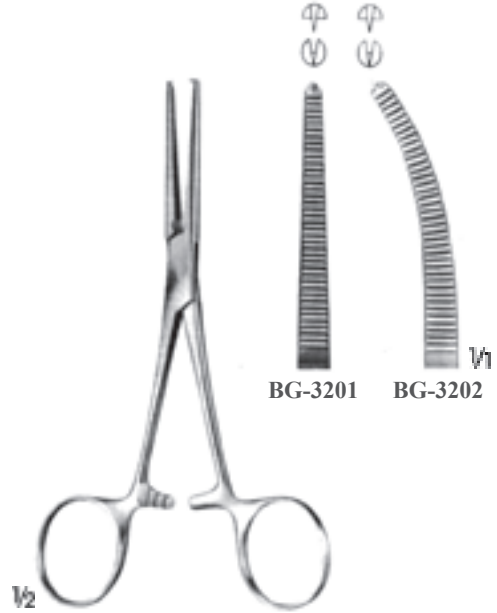

ROCHESTER-OCHSNER
BG-3201 - BG-3202
14 cm

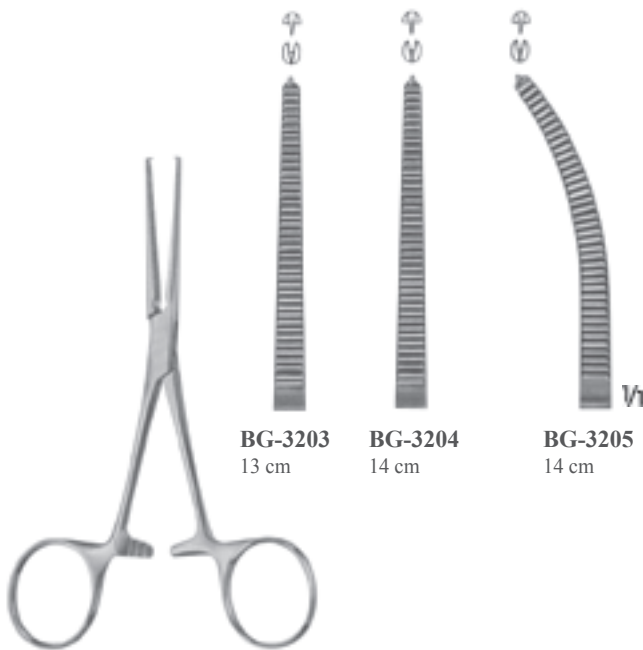

KOCHER
BG-3203 - BG-3205



KOCHER
BG-3207 - BG-3208
15 cm



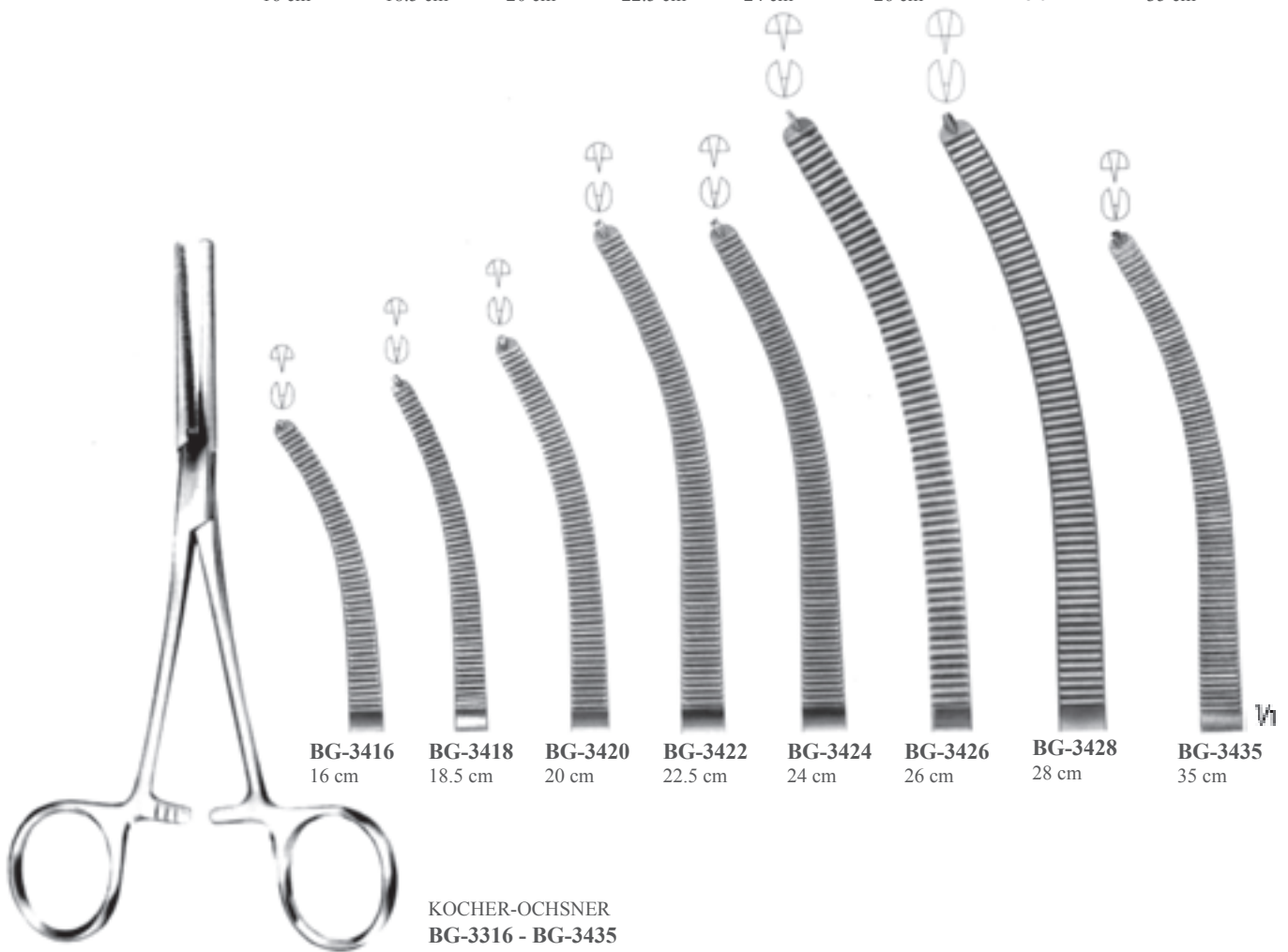
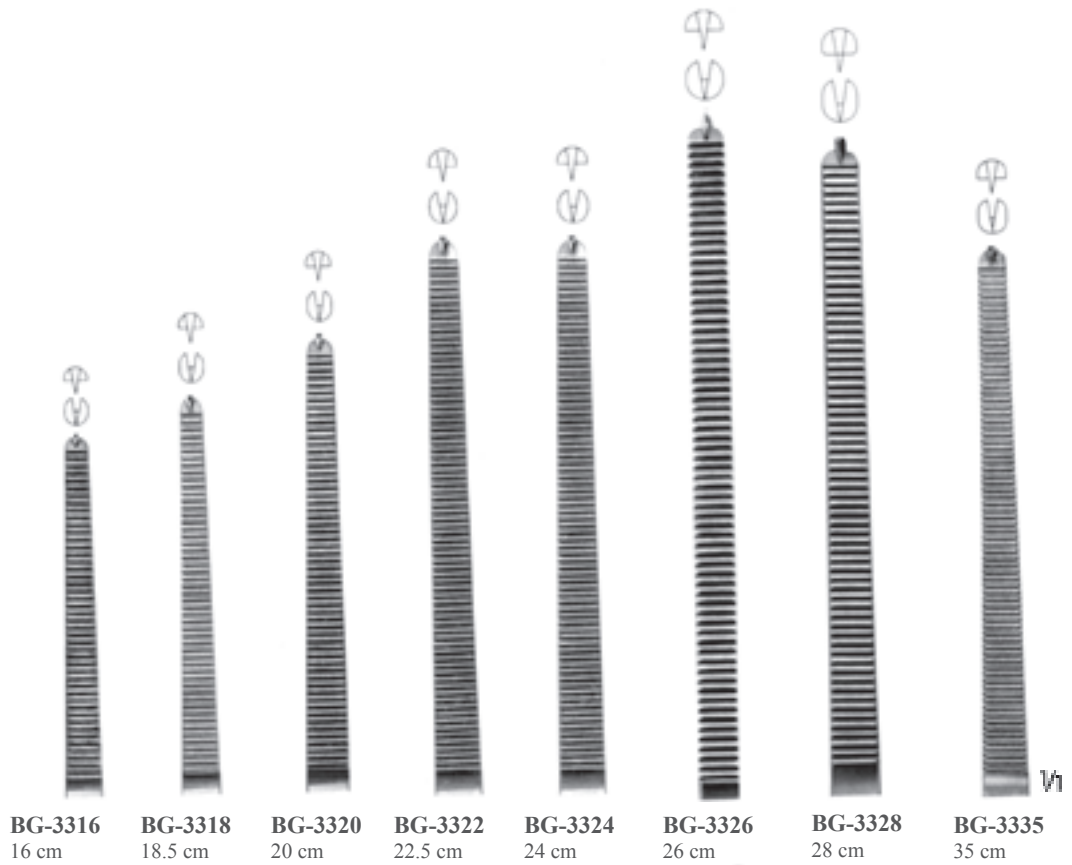



BG-3516
16 cm

ROCHESTER-CARMALT
BG-3516 - BG-3620



BG-3520
20 cm

BG-3616
16 cm

BG-3620
20 cm



BG-3209

FICKLING
BG-3209 - BG-3210
18 cm



BG-3210
1x2 diş
1x2 teeth



MOYNIHAN
BG-3707 - BG-3708

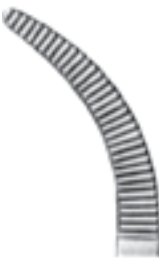

BG-3707
23 cm



BG-3708
24 cm



ROBERTS
BG-3705 - BG-3706
25 cm

BG-3705

BG-3706





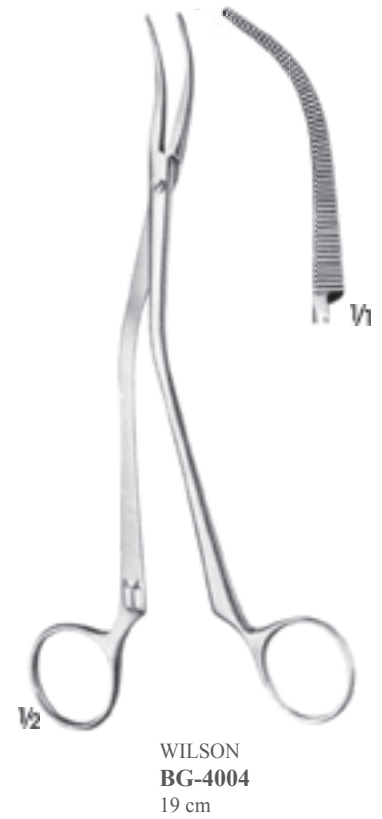
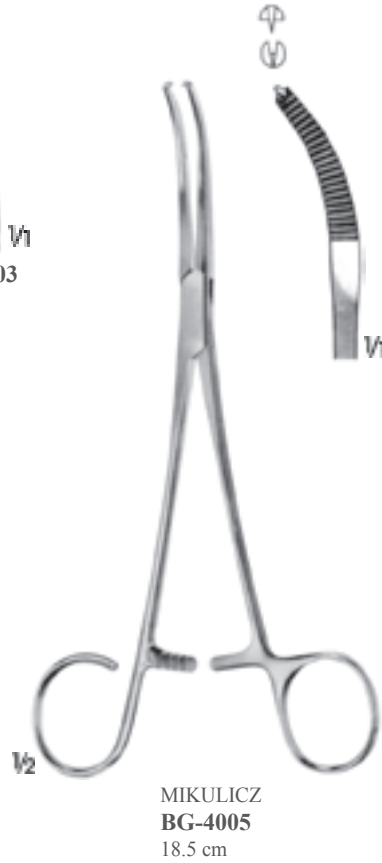
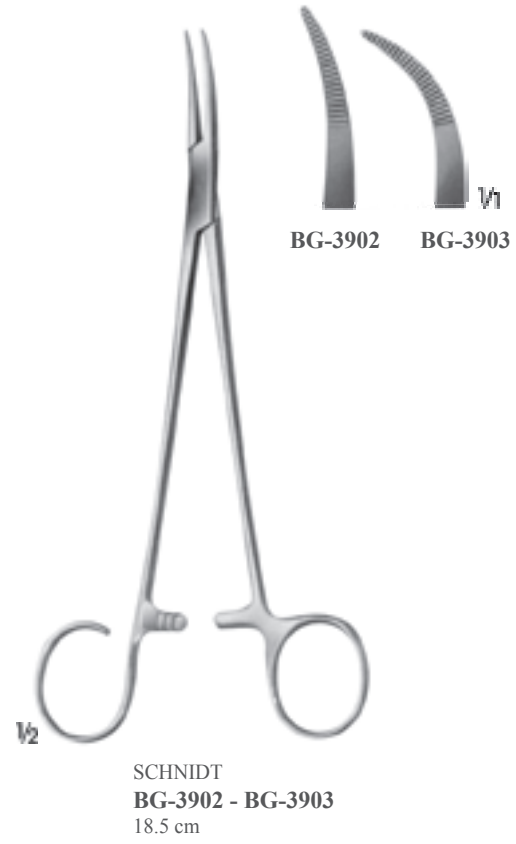

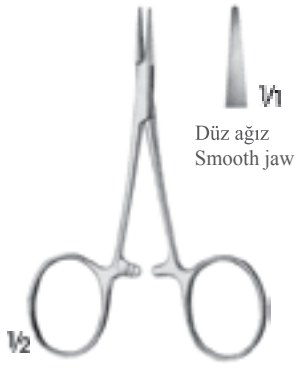

Düz ağız
Smooth jaw

BG-4206

Ligatür pens, düz
Ligature forceps, straight
9.5 cm



MICRO-ADSON

BG-4207

Diseksiyon pens
Dissecting forceps
14 cm

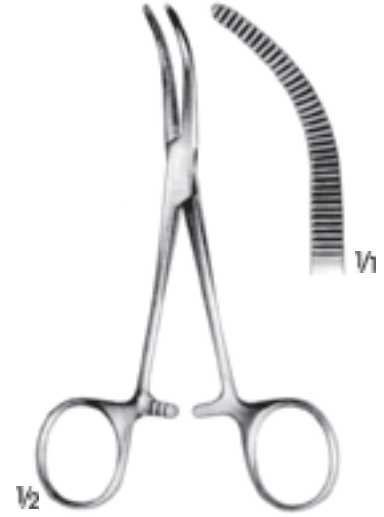

BABY-OVERHOLT

BG-4208

Diseksiyon pens
Dissecting forceps
13.5 cm



BG-4209
14 cm

BG-4210
18 cm

BABY-MIXTER

BG-4209 - BG-4210

Diseksiyon pensleri
Dissecting forceps

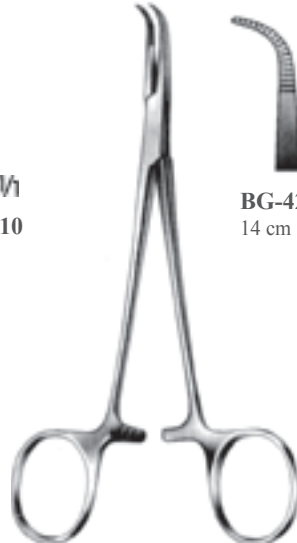

BG-4211
14 cm

BG-4212
18 cm

BABY-ADSON

BG-4211 - BG-4212

Diseksiyon pensleri
Dissecting forceps

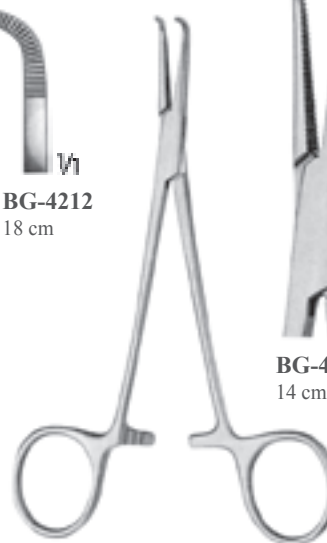

BG-4225
14 cm

BG-4226
18 cm

BG-4225 - BG-4226

Diseksiyon pensleri
Dissecting forceps



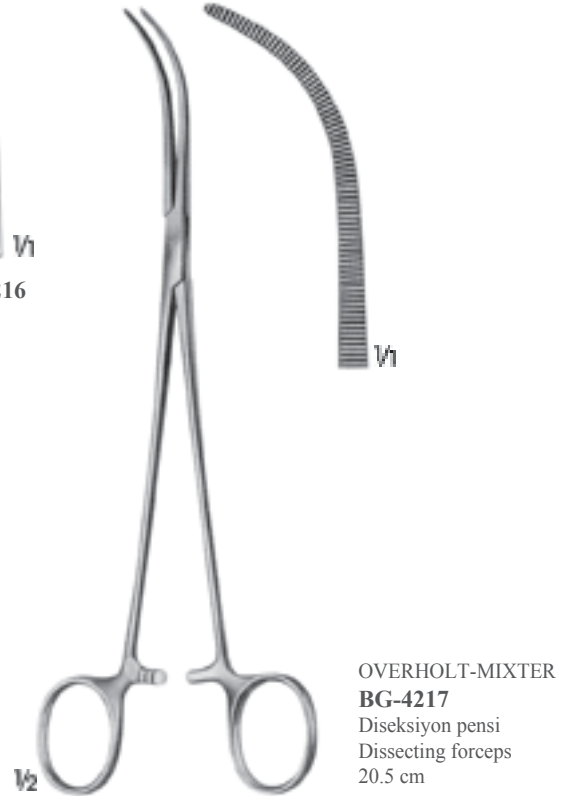
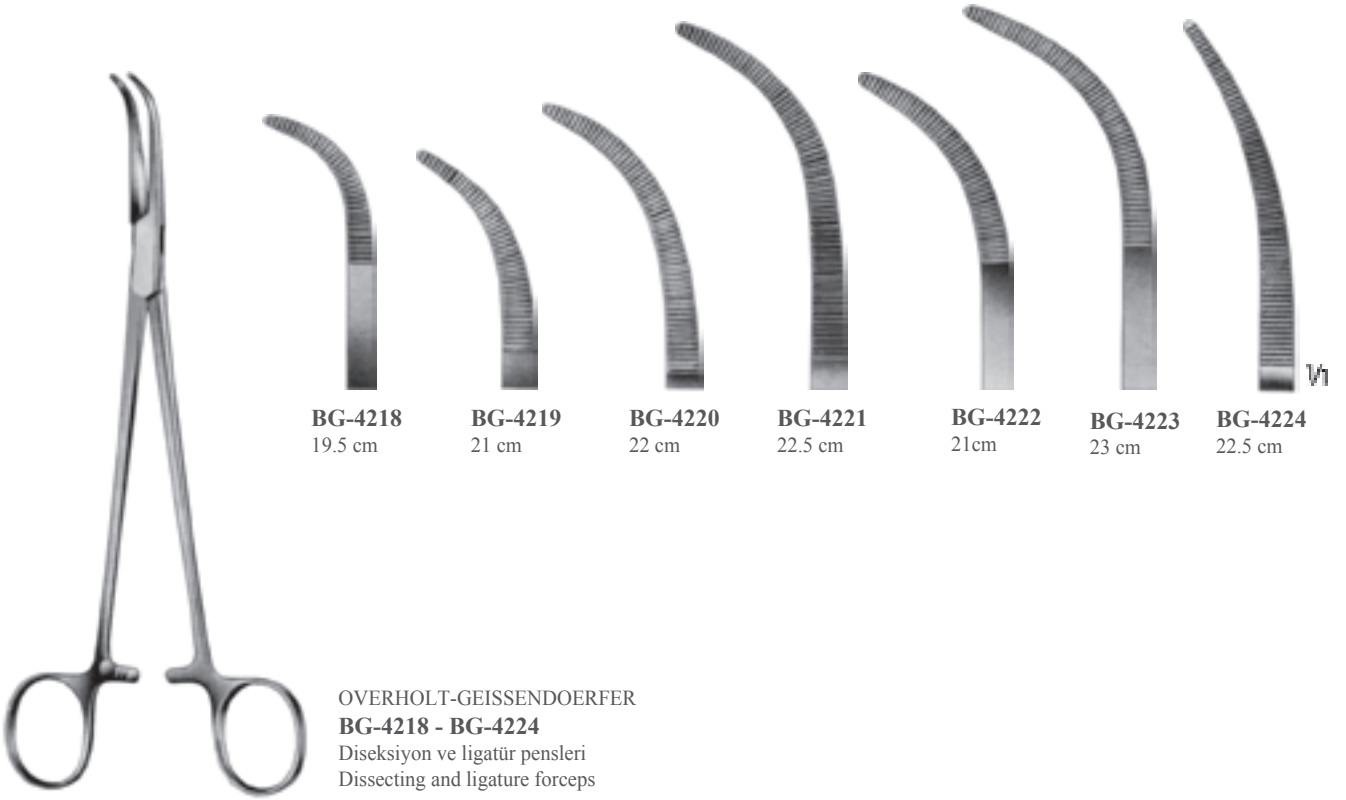



BG-4227
21.5 cm

BG-4228
21 cm

BG-4229
22 cm

BG-4230
22.5 cm

BG-4231
22.5 cm

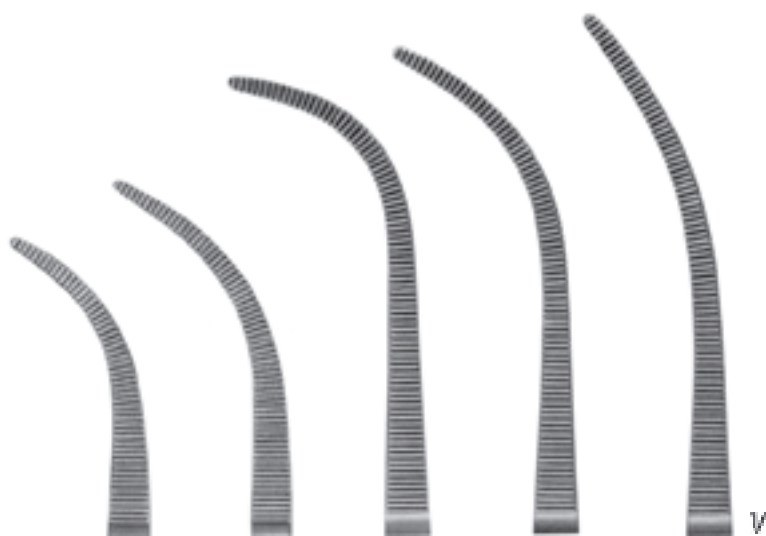

BG-4235
27 cm

BG-4236
27 cm

BG-4232
29.5 cm

BG-4233
29.5 cm

BG-4234
30 cm



OVERHOLT
BG-4227 - BG-4234
Hassas model/Delicate pattern





BG-4237
26 cm

BG-4238
27 cm

BG-4239
27.5 cm

BG-4240
27 cm

BG-4241
28 cm

OVERHOLT-GEISSENDOERFER
BG-4237 - BG-4241



BG-4413
13 cm

BG-4418
18 cm

BG-4420
20 cm

BG-4423
23 cm

BG-4428
28 cm

GEMINI
BG-4413 - BG-4428



BG-4615
15 cm



BG-4618
18 cm



BG-4620
20 cm



BG-4623
23 cm



BG-4625
25.5 cm

O'SHAUGHNESSY
BG-4615 - BG-4625

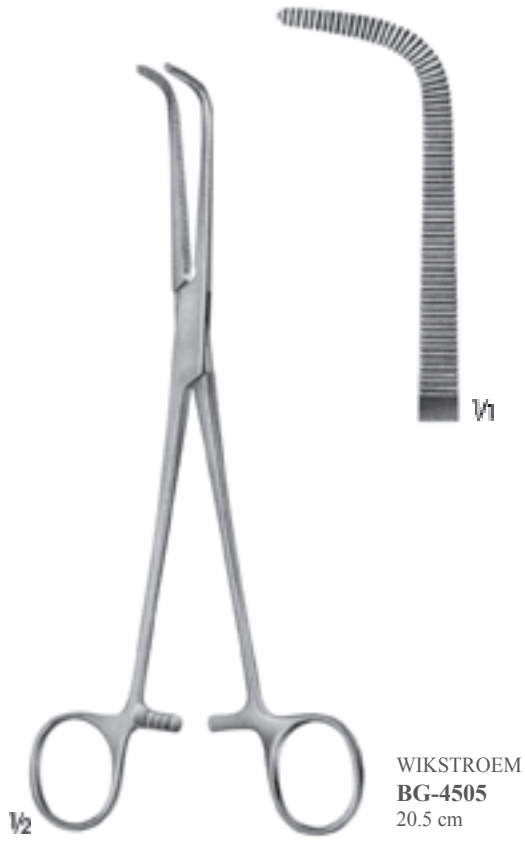



RUMEL
BG-4910 - BG-4914
24 cm

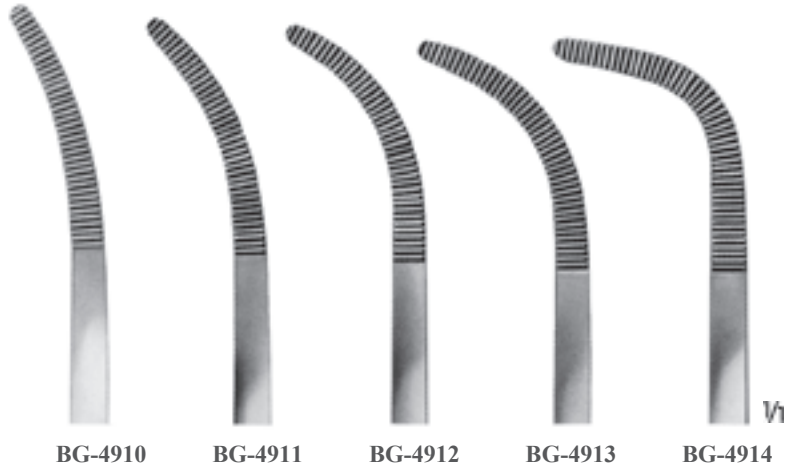

KANTROWITZ
BG-4820 - BG-4827

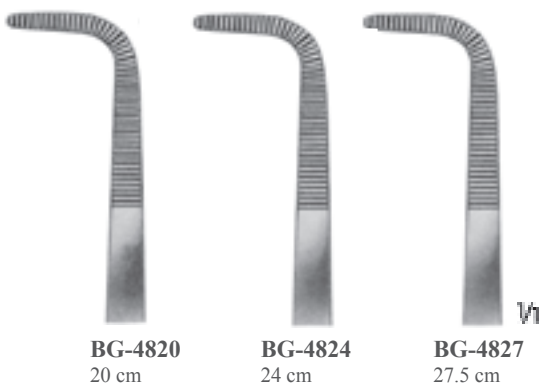

BG-4820
20 cm

BG-4824
24 cm

BG-4827
27.5 cm



BARRE
BG-4900 - BG-4901
28 cm

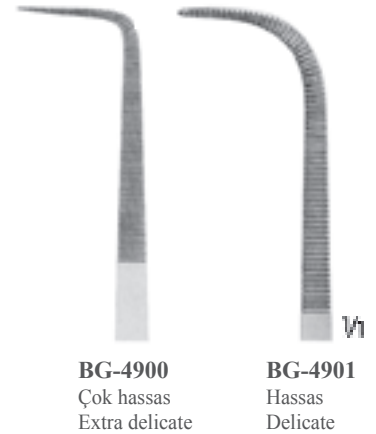

BG-4900
Çok hassas
Extra delicate

BG-4901
Hassas
Delicate





ZENKER
BG-5010 - BG-5014



BG-5010
30 cm



BG-5011
29 cm



BG-5012
35 cm



BG-5013
35 cm



BG-5014
35 cm





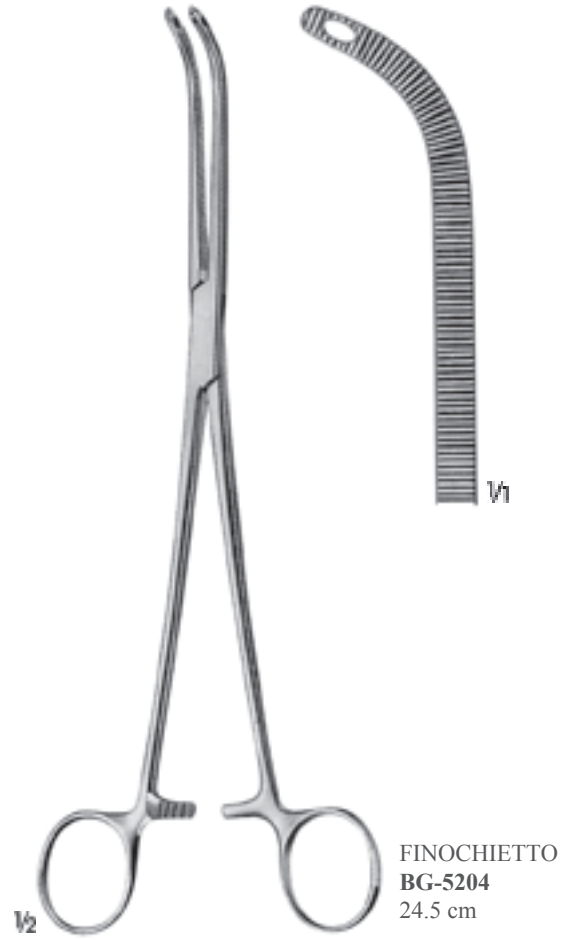
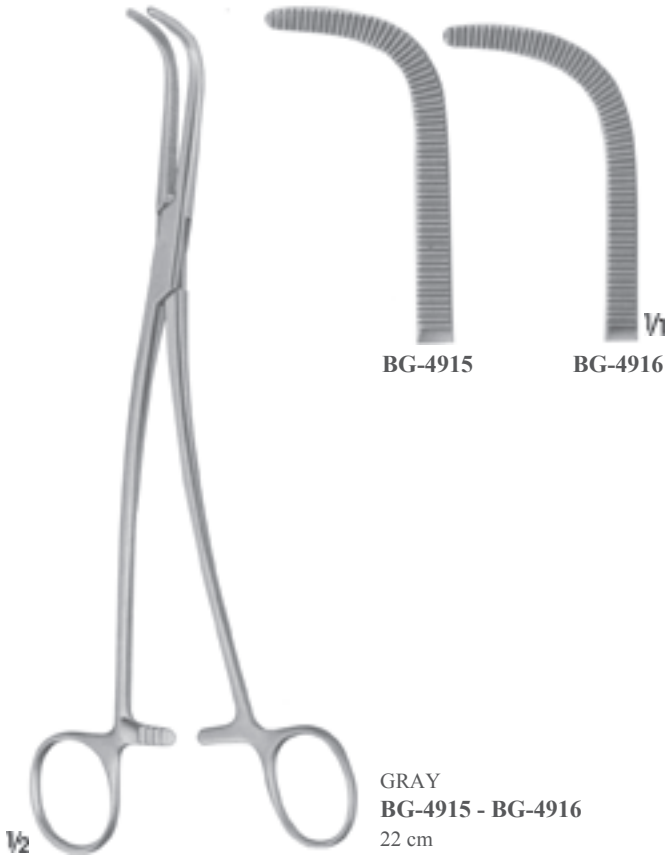
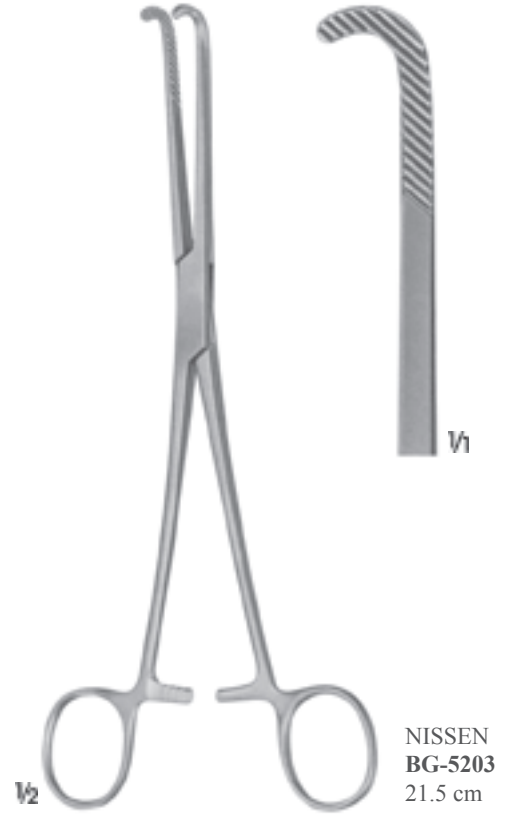





BABY-MIKULICZ
BG-5300
14 cm



MIKULICZ
BG-5301
18.5 cm



BG-5302
18 cm

BG-5303
20.5 cm



MIKULICZ
BG-5304
20.5 cm



MIKULICZ
BG-5305
20.5 cm



MIKULICZ
BG-5306
20 cm

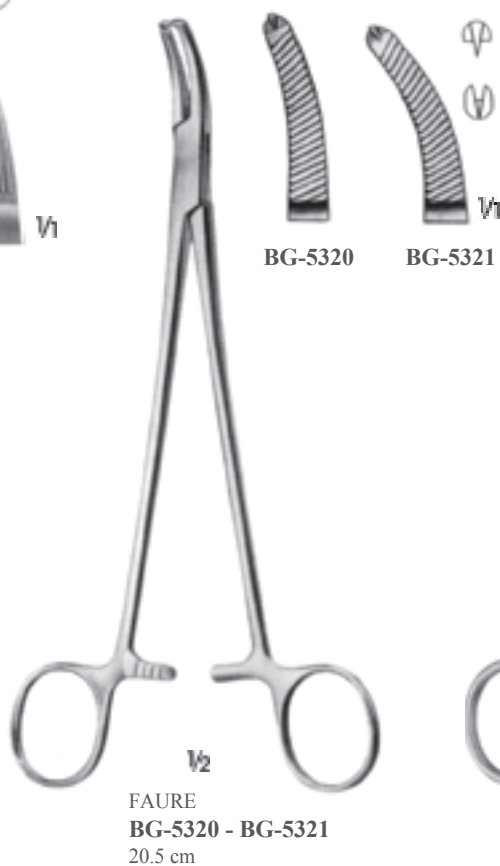

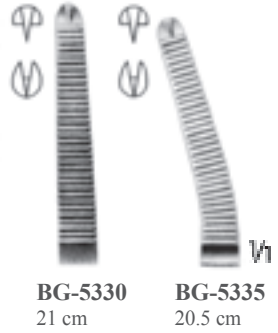

BG-5330
21 cm

BG-5335
20.5 cm

PHANEUF
BG-5330 - BG-5335

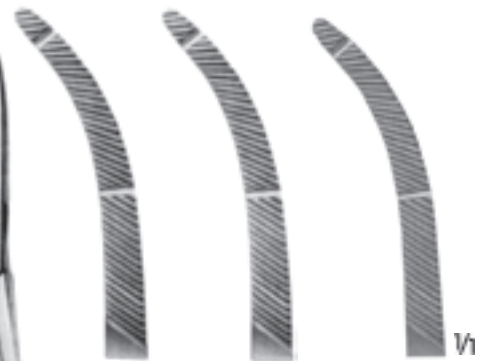

BG-5420
20.5 cm

BG-5424
24.5 cm

BG-5435
35 cm

HEANEY
BG-5420 - BG-5435



HEANEY
BG-5419
19.5 cm



BG-5500
22 cm

BG-5501
24 cm

WIENER MODELL
BG-5500 - BG-5501

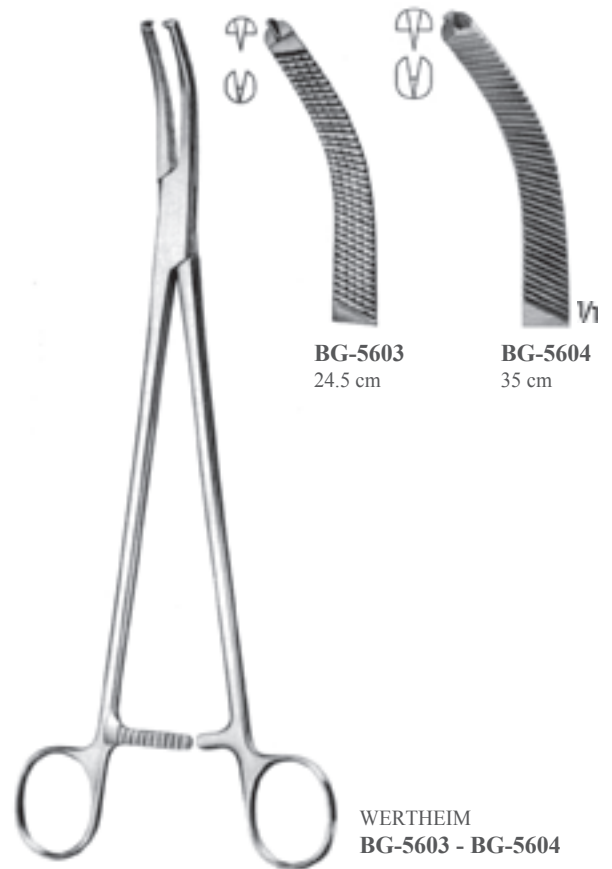
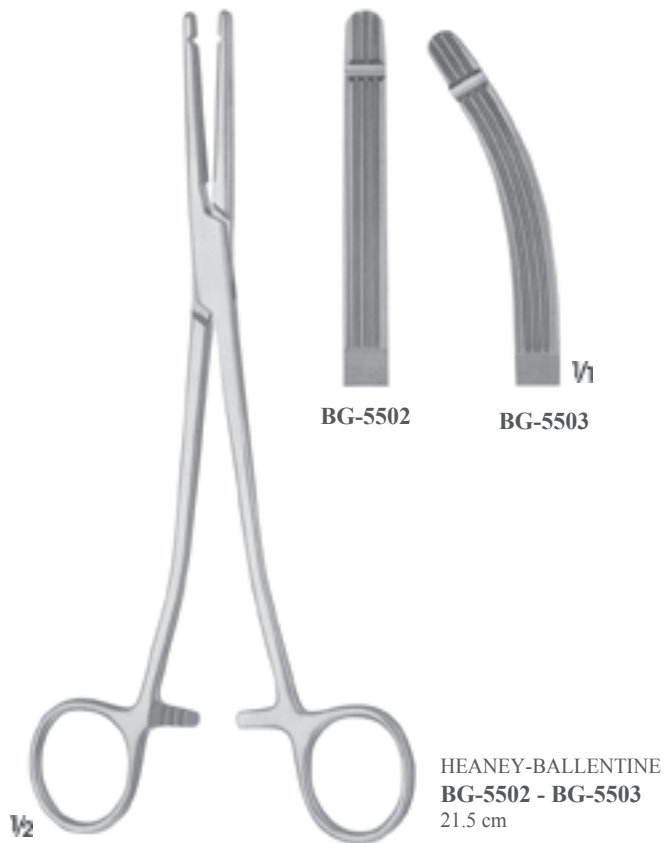
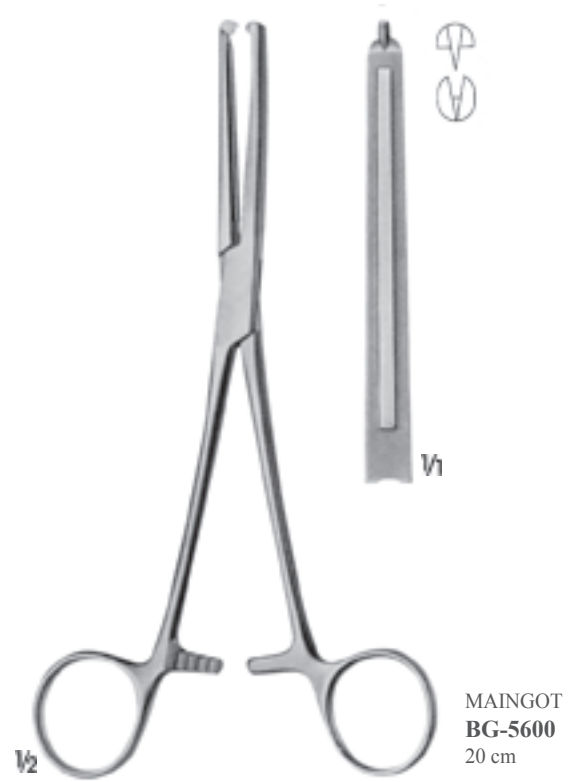



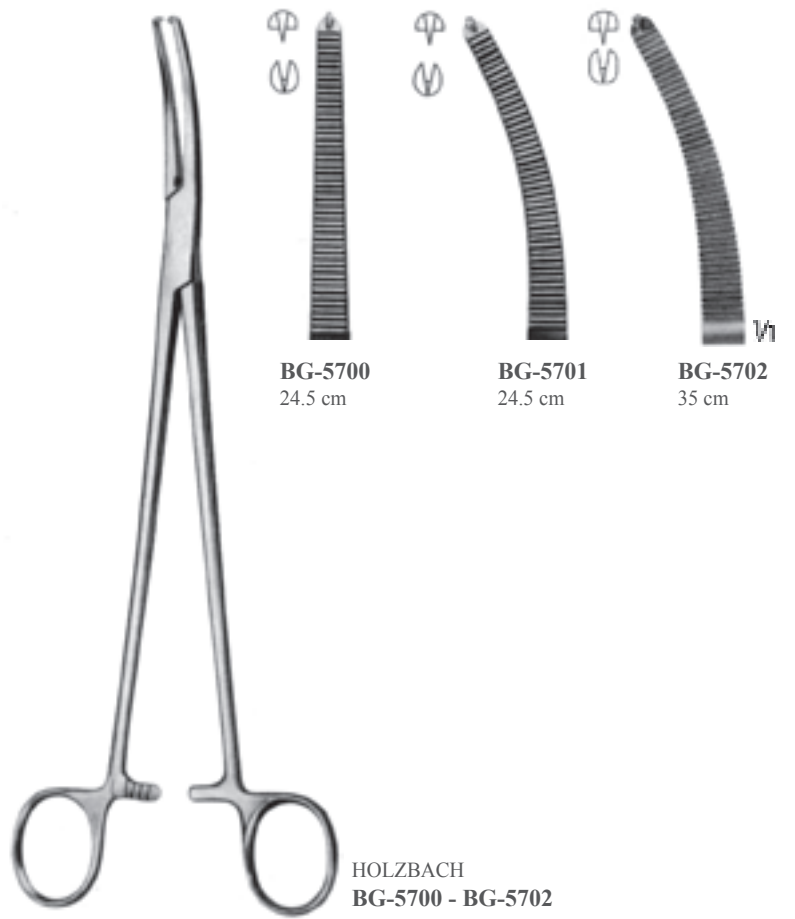
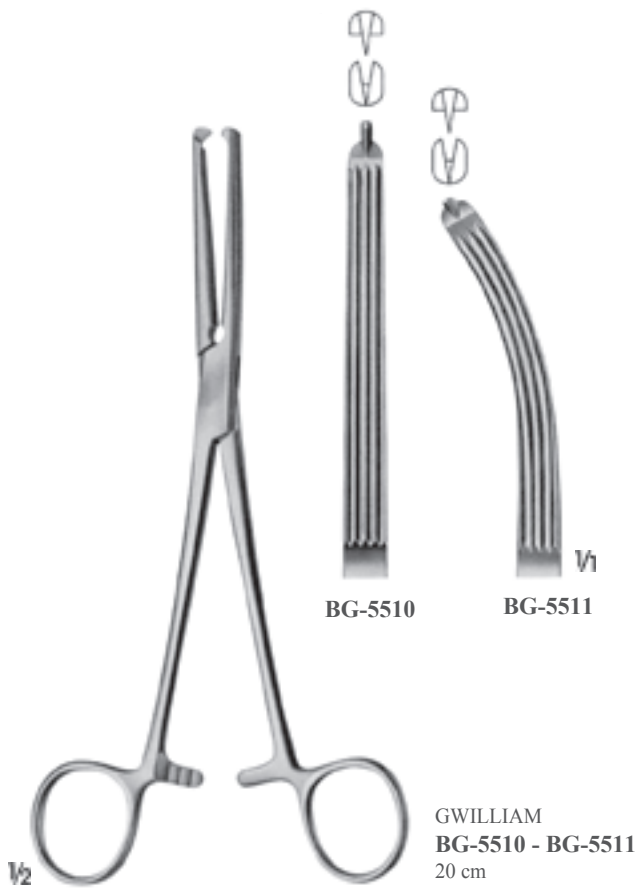



De Bakey Diş



Toothing De Bakey



BG-6300
22.5 cm

BG-6301
22 cm

BG-6302
21.5 cm

BG-6303
20.5 cm

HEANEY
BG-6300 - BG-6303



BG-6400
25 cm

BG-6401
24.5 cm

BG-6402
24 cm

BG-6403
22 cm

WERTHEIM
BG-6400 - BG-6403

De Bakey Diş



Toothing De Bakey



BG-6500
25 cm



BG-6501
35 cm



BG-6502
25 cm



BG-6503
35 cm

KIEBACK
BG-6500 - BG-6501
BG-6502 - BG-6503





WERTHEIM
BG-6600
25.5 cm



WERTHEIM
BG-6601
26 cm





BURKE
BG-6700 - BG-6701
Parametrium pensisi kısa ağız
Parametrium clamp, short jaw part



BURKE
BG-6702 - BG-6703
Parametrium pensisi uzun ağız
Parametrium clamp, long jaw part

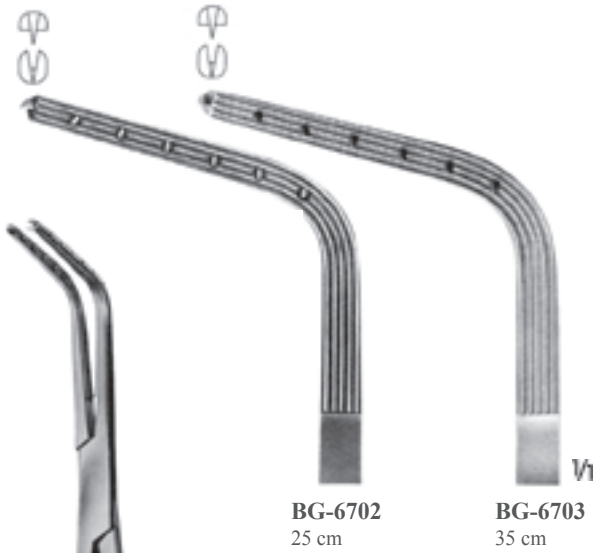



De Bakey Diş



Toothing De Bakey



BH-2078
25.5 cm

BH-2088
26.5 cm

BH-2098
27.5 cm



90°

67 mm

V2

DICK
BH-2078 - BH-2098

WERTHEIM
BG-6615
25 cm



V2

BH-2160 - BH-2180
23 cm



V2

WERTHEIM-CULLEN
BG-6620
21.5 cm



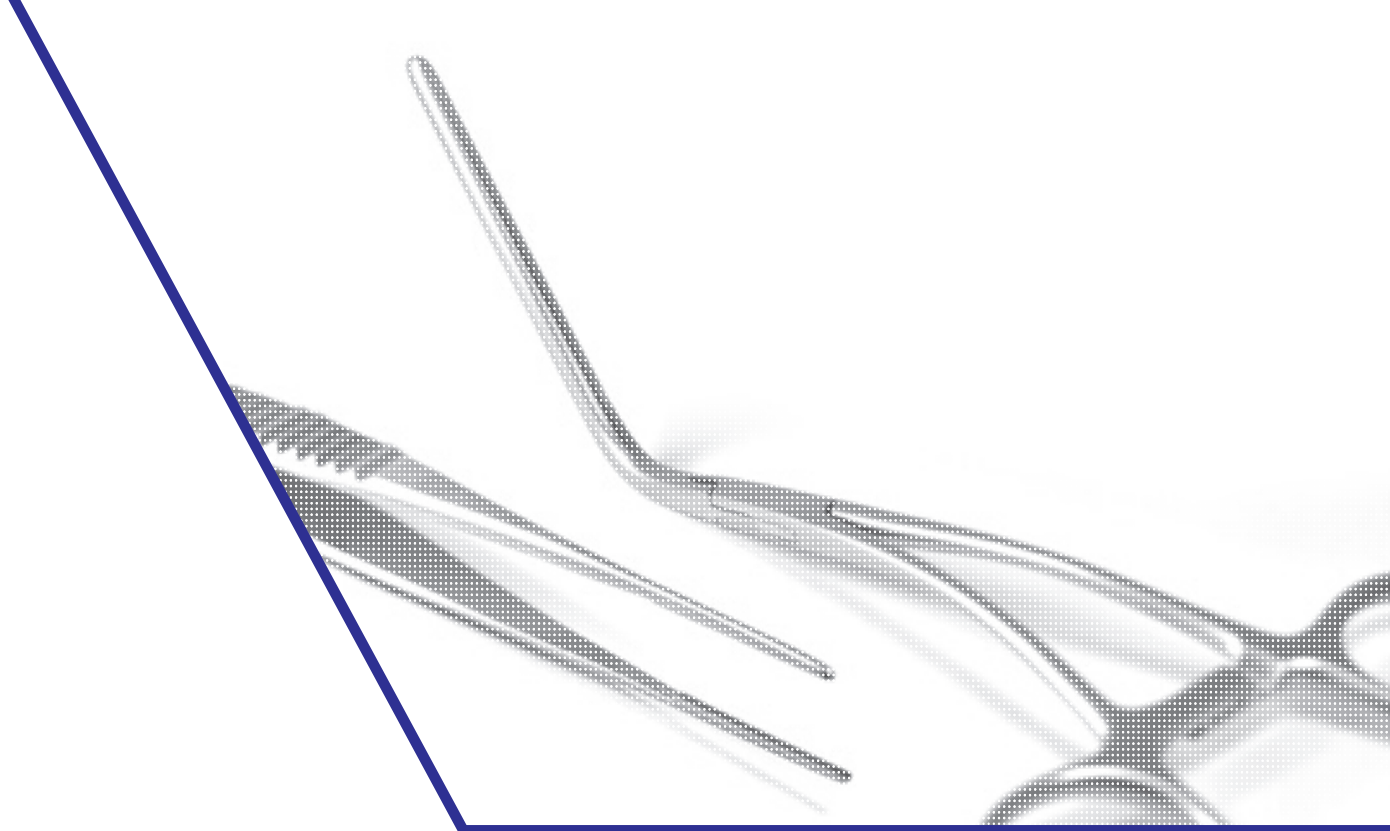

BH

Kalp Damar Cerrahi
Cardiovascular and Thoracic Surgery





De Bakey Diş



Toothing De Bakey

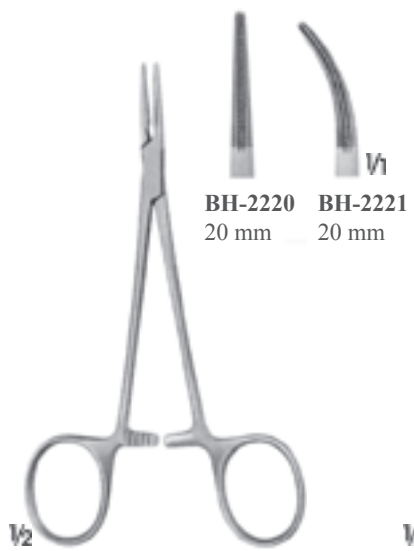

MOSQUITO
BH-2220 - BH-2221
12.5 cm



DE BAKEY-KELLY
BH-2222 - BH-2223
14 cm

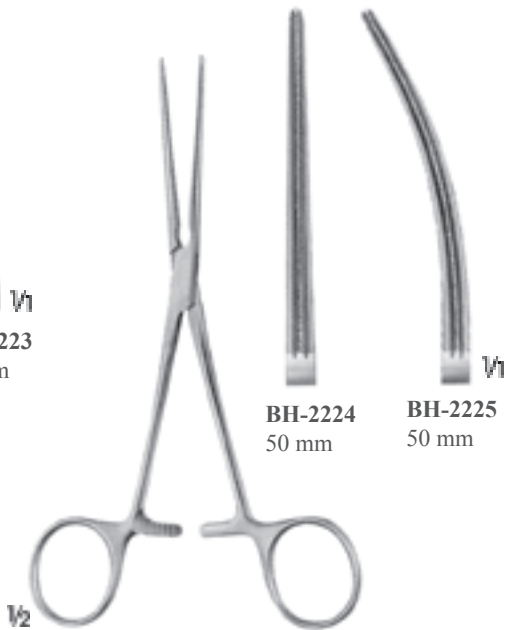

PEAN
BH-2224 - BH-2225
15.5 cm



DE BAKEY-BAINBRIDGE
BH-2226 - BH-2227
15.5 cm



BH-2228 - BH-2229
16.5 cm



DE BAKEY-BAINBRIDGE
BH-2230 - BH-2231
18 cm

De Bakey Diş



Toothing De Bakey



DE BAKHEY-PEAN
BH-4220 20 cm
BH-4226 26.5 cm
BH-4228 28 cm

DE BAKHEY-PEAN
BH-4320 20 cm
BH-4326 26.5 cm
BH-4327 27.5 cm

BH-4220
60 mm

BH-4226
89 mm

BH-4228
99 mm

BH-4320
60 mm

BH-4326
89 mm

BH-4327
99 mm





De Bakey Diş



Toothing De Bakey

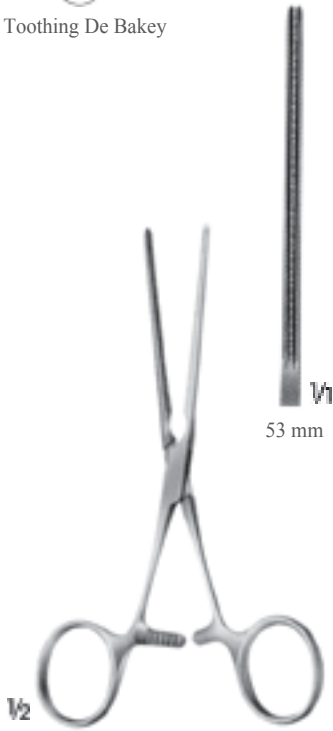

DE BAKEY
BH-4400
Düz/Straight
13 cm



DE BAKEY
BH-4401
Eğri/Curved
12.5 cm

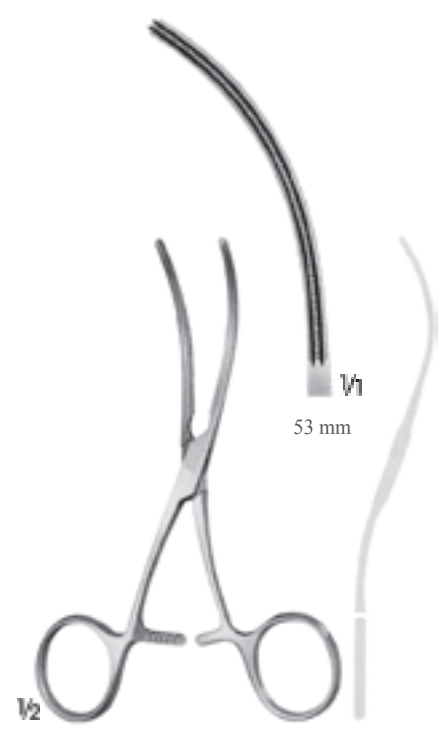

DE BAKEY
BH-4402
S-Biçimli/S-shaped
12.5 cm



DE BAKEY
BH-4404
90° açılı/Angled 90°
10.5 cm



NOON
BH-4405
40° açılı/Angled 40°
11 cm

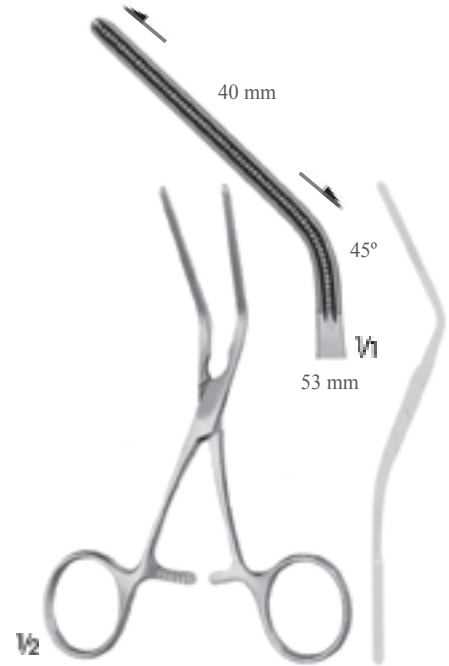

DE BAKEY
BH-4403
45° açılı/Angled 45°
12.5 cm

De Bakey Diş



Toothing De Bakey



1/2

CASTANEDA
BH-4440 - BH-4443
15.5 cm

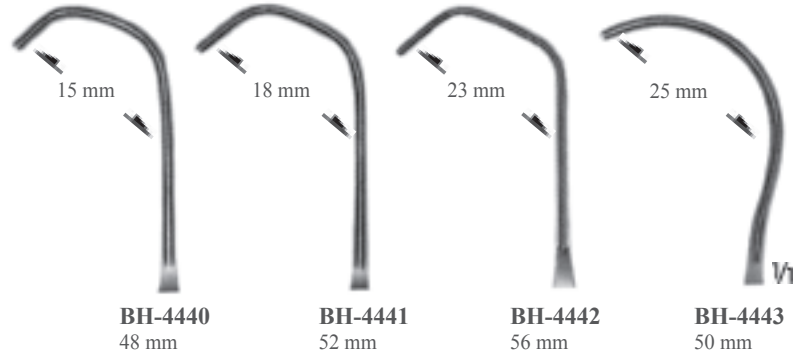

CASTANEDA
BH-4406 12.5 cm
BH-4407 12 cm
BH-4408 12 cm
BH-4409 10.5 cm

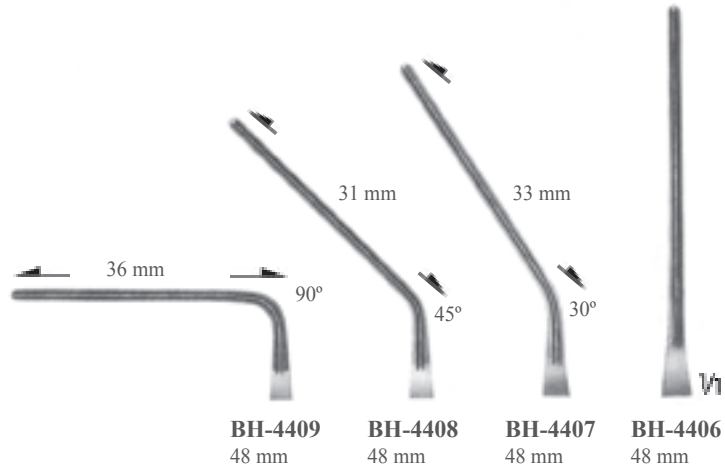



De Bakey Diş



Toothing De Bakey



DE BAKEY
BH-4460 - BH-4461

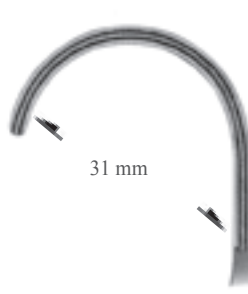

BH-4460
16 cm

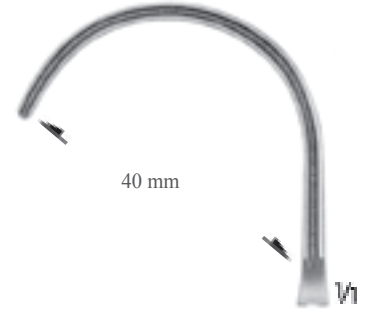

BH-4461
17 cm



COOLEY
BH-4490 - BH-4492

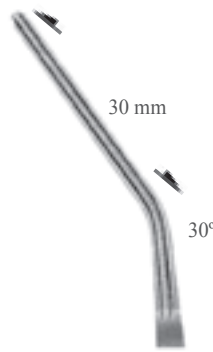

BH-4492
16.5 cm



BH-4491
16 cm

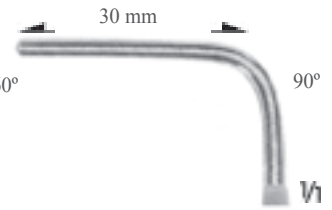

BH-4490
15 cm



De Bakey Diş



Toothing De Bakey



DERRA
BH-4495 - BH-4497



BH-4495
17 cm



BH-4496
17 cm

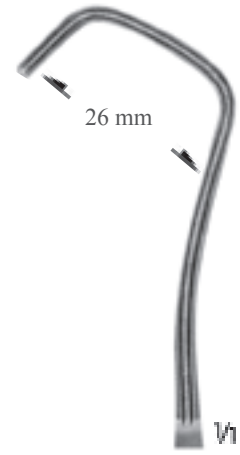

BH-4497
17.5 cm

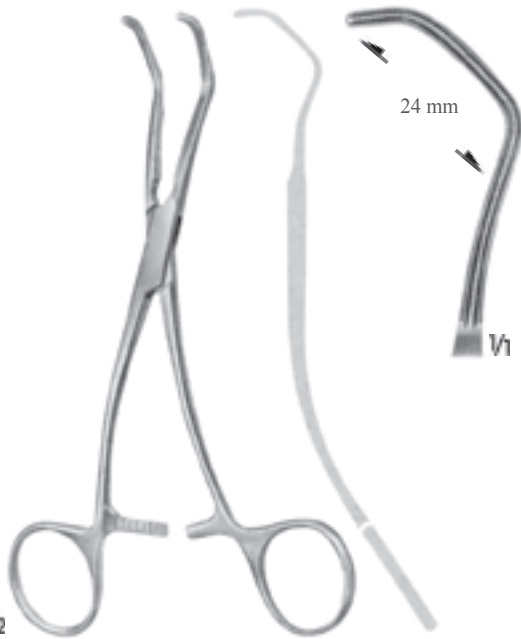

V₂

COOLEY
BH-4500
16 cm

24 mm

V₁

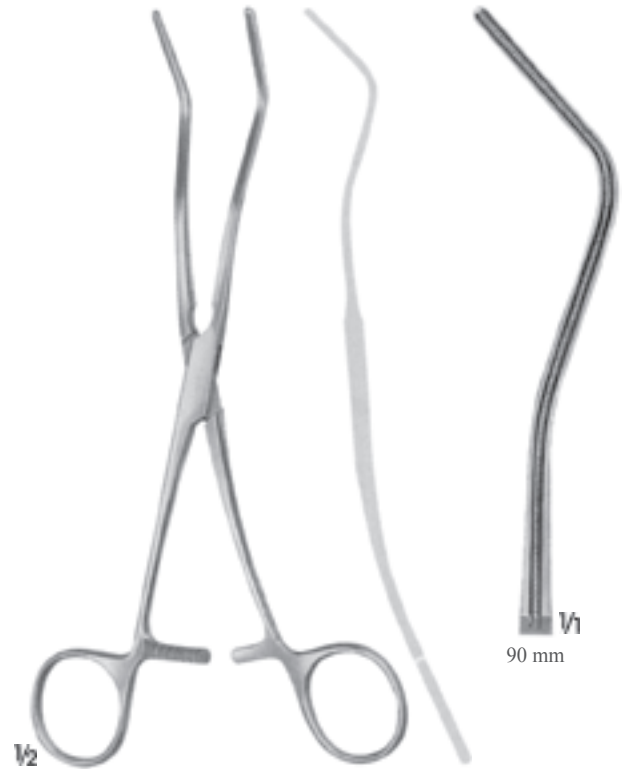

V₂

COOLEY
BH-4520
20 cm

V₁
90 mm





De Bakey Diş



Toothing De Bakey



GLOVER
BH-3310 19.5 cm
BH-3311 21 cm

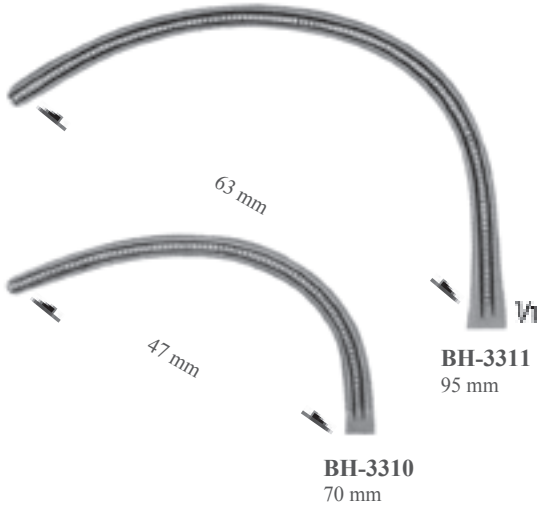

BH-3310
70 mm

BH-3311
95 mm



GLOVER
BH-3312
22 cm

60 mm

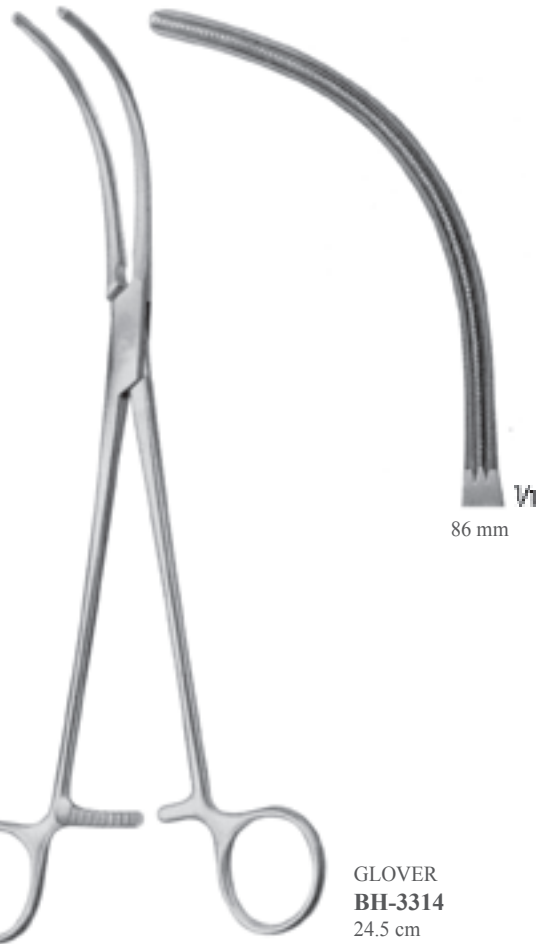

65 mm

86 mm

$\frac{1}{2}$

$\frac{1}{2}$

GLOVER
BH-3313
21.5 cm

GLOVER
BH-3314
24.5 cm

De Bakey Diş



Toothing De Bakey



BH-4601
86 mm



BH-4602
86 mm



BH-4603
86 mm



BH-4604
86 mm

DE BAKEY-HARKEN

BH-4601 25.5 cm

BH-4602 24.5 cm

BH-4603 24.5 cm

BH-4604 24.5 cm

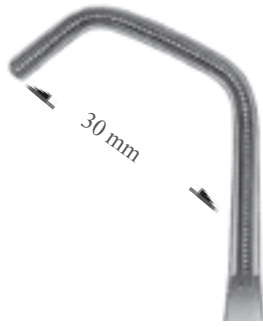

BH-4530
65 mm

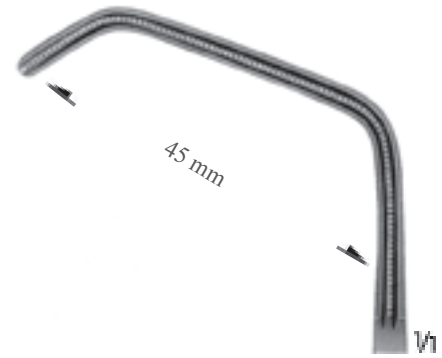

BH-4531
80 mm

DE BAKEY-BECK

BH-4530 20.5 cm

BH-4531 21 cm





De Bakey Diş



Toothing De Bakey



DE BAKEY

- BH-4701** 22 cm
- BH-4702** 26.5 cm
- BH-4703** 27 cm
- BH-4704** 27 cm
- BH-4705** 28 cm

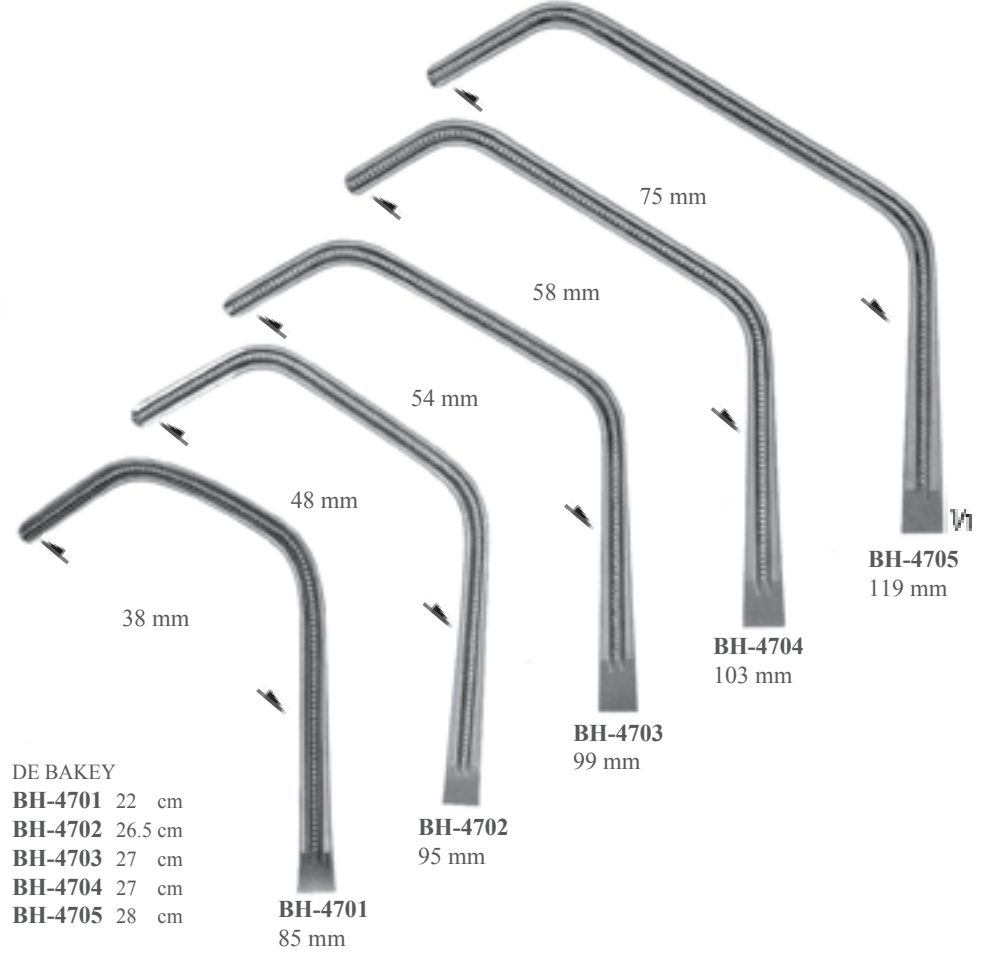

DE BAKEY-SATINSKY

- BH-4710** 23.5 cm
- BH-4720** 24 cm
- BH-4725** 24.5 cm

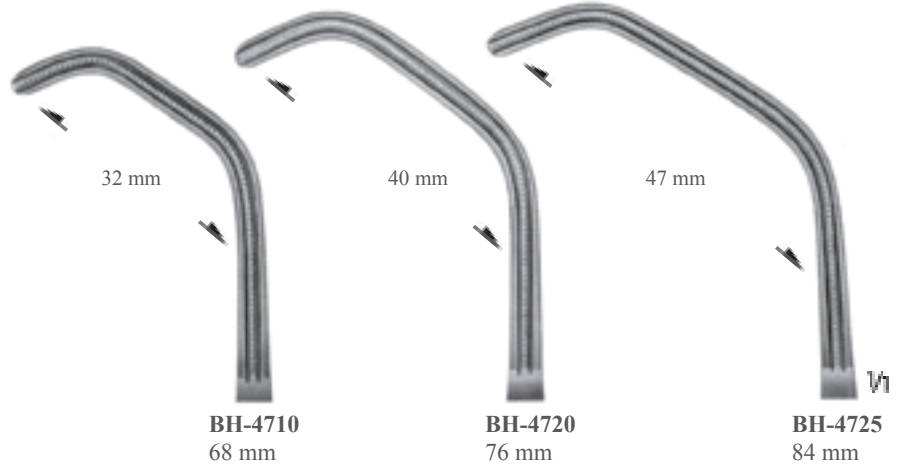

De Bakey Diş



Toothing De Bakey

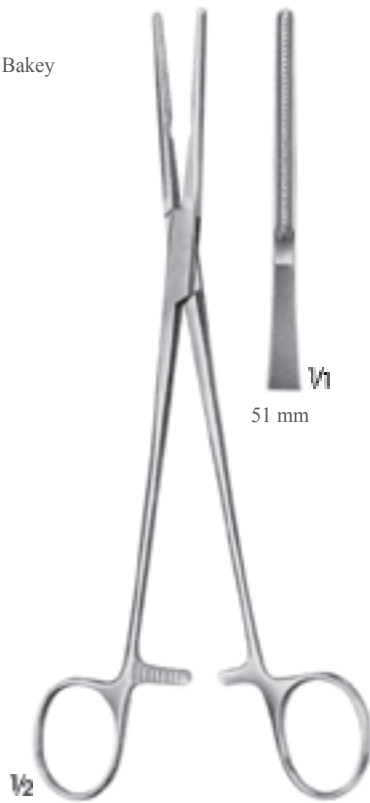

DE BAKEY
BH-2500
21 cm



DE BAKEY
BH-2501
21 cm



DE BAKEY
BH-3302
16 cm

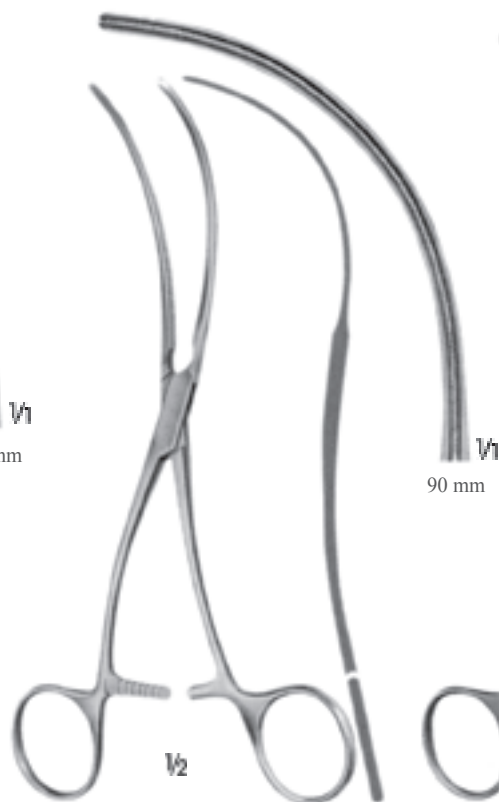

DE BAKEY
BH-3303
19 cm

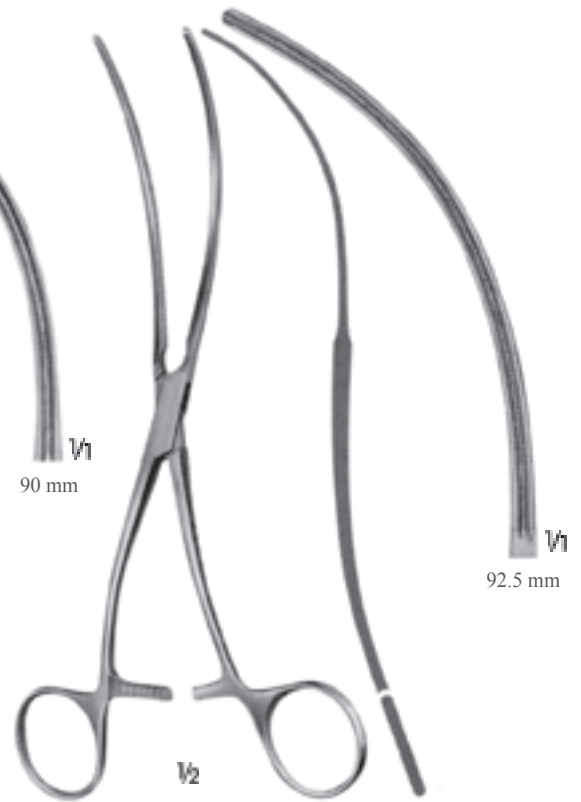

DE BAKEY
BH-3304
20 cm





De Bakey Diş



Toothing De Bakey

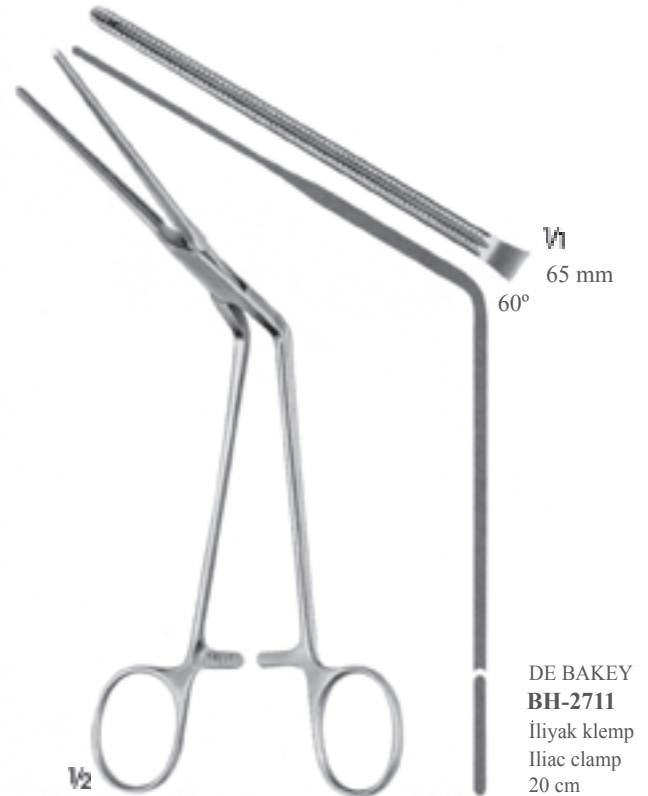
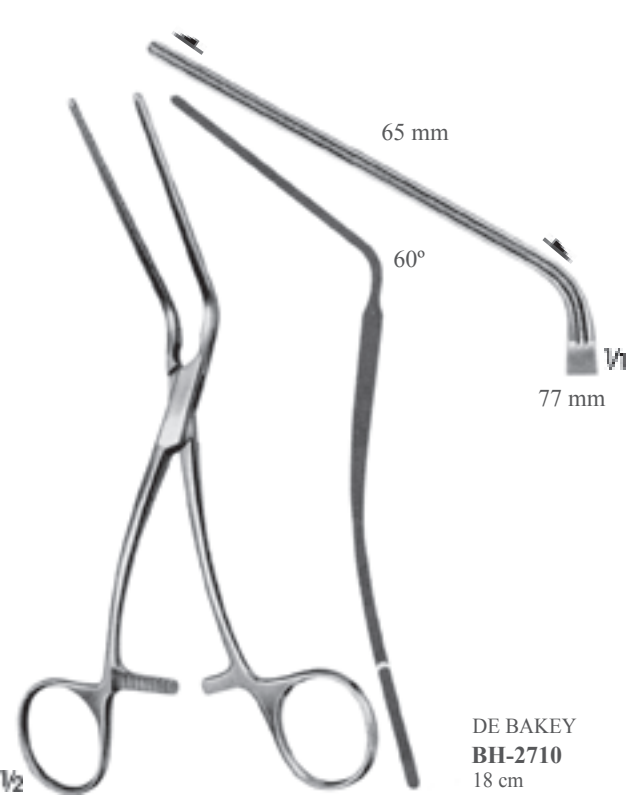
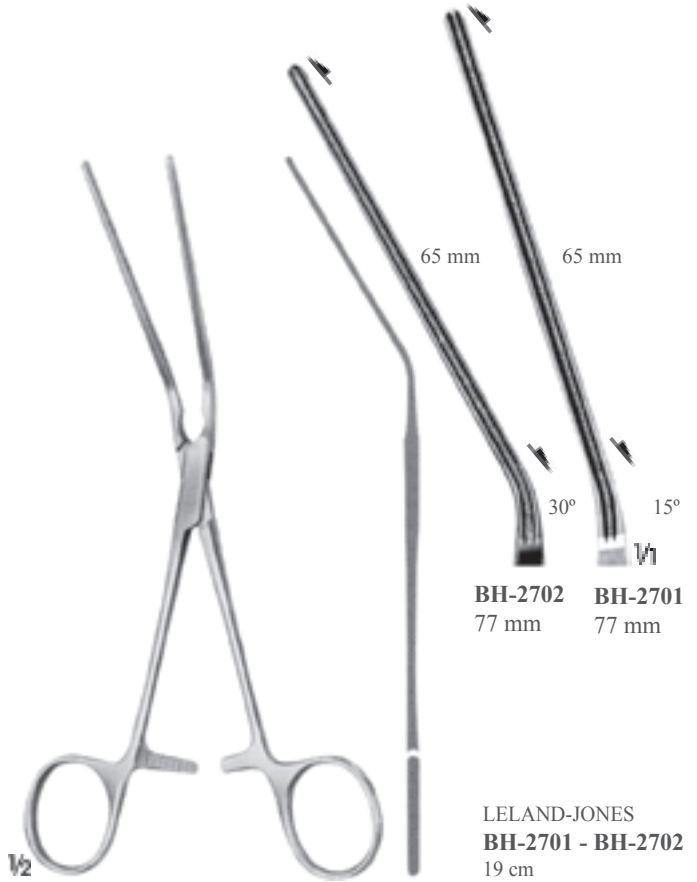

De Bakey Diş



Toothing De Bakey

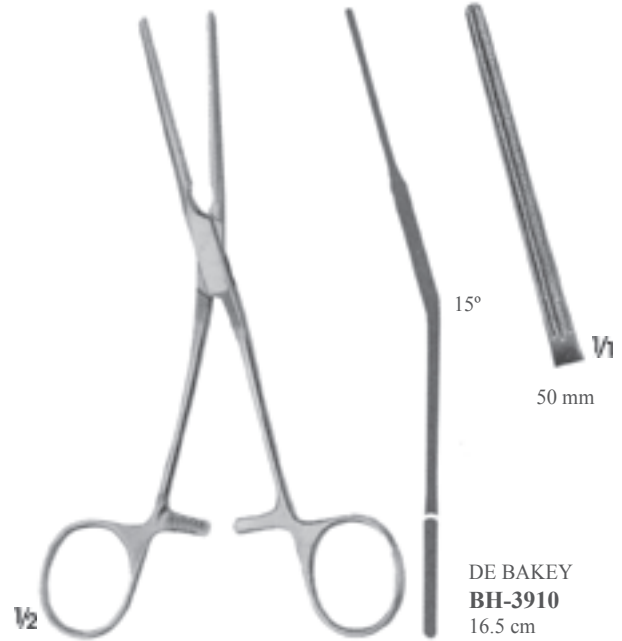
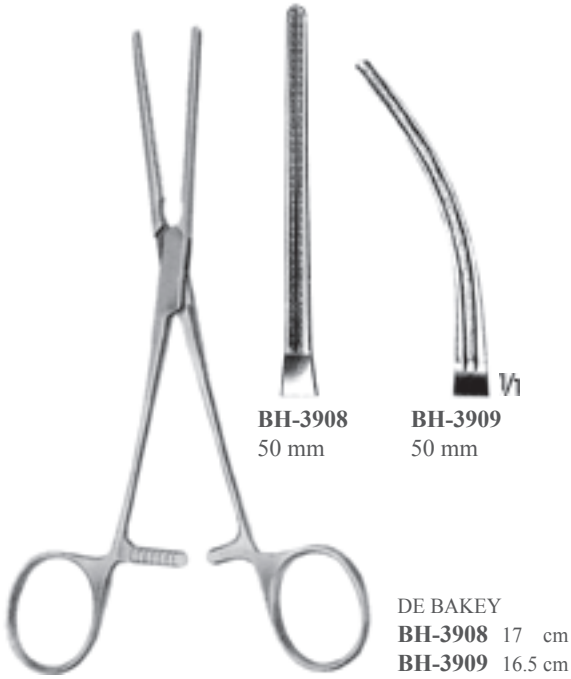

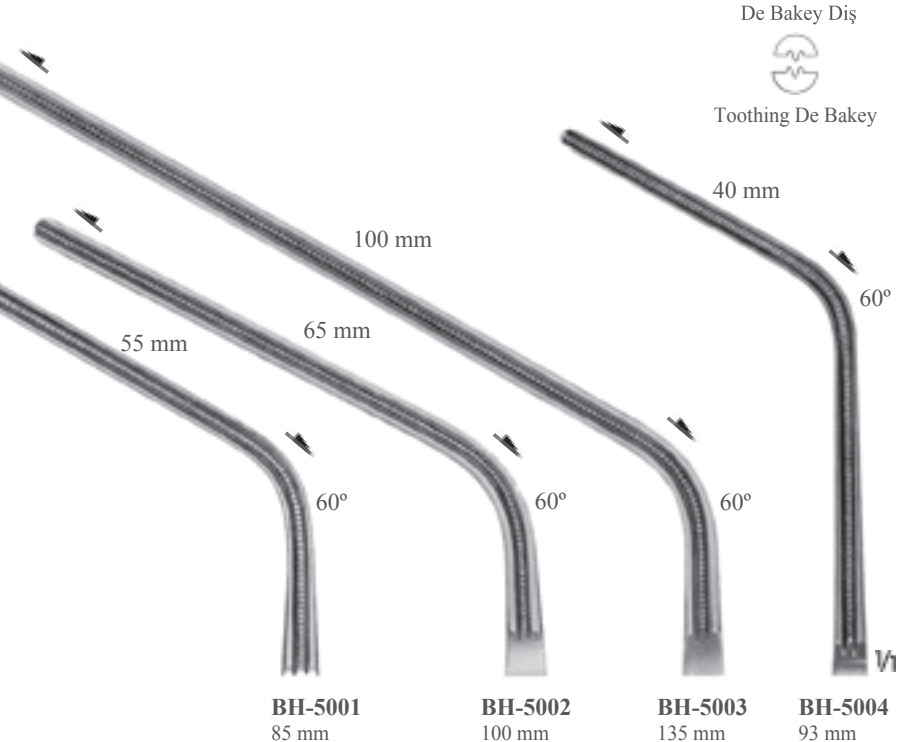

DE BAKEY
BH-5001 23 cm
BH-5002 28 cm
BH-5003 30.5 cm
BH-5004 24 cm

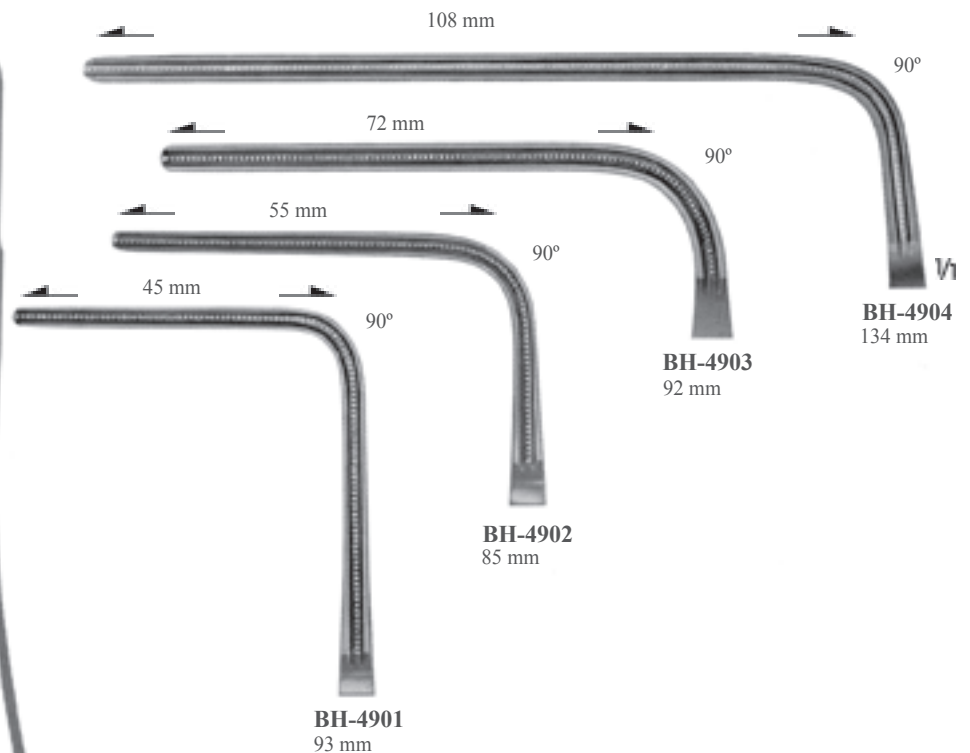

DE BAKEY
BH-4901 22.5 cm
BH-4902 21 cm
BH-4903 25.5 cm
BH-4904 27.5 cm

De Bakey Diş



Toothing De Bakey

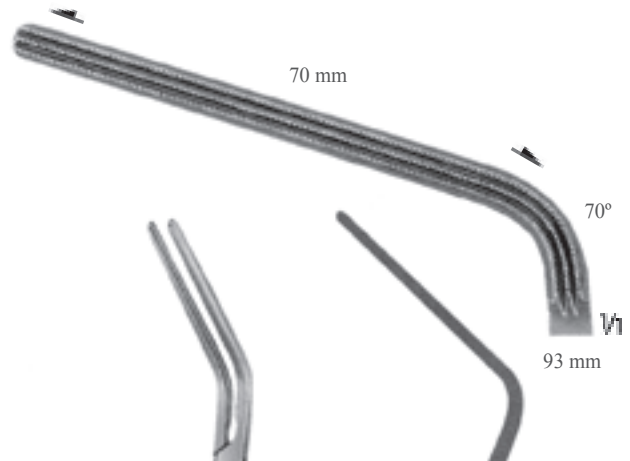
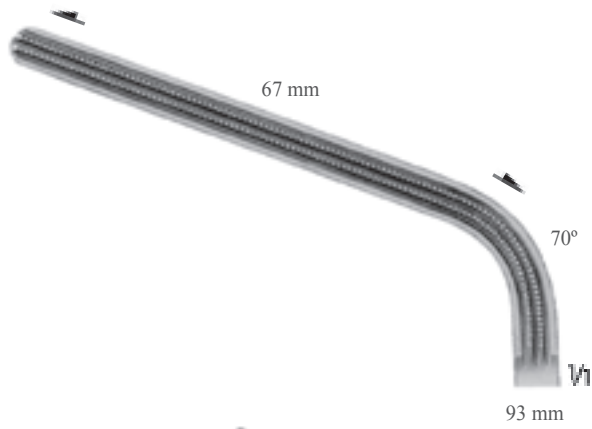



De Bakey Diş



Toothing De Bakey



BH-3825
70 mm

BH-3826
75 mm

BH-3828
85 mm



115 mm



DE BAKEY
BH-3825 25.5 cm
BH-3826 26.5 cm
BH-3828 28 cm



DE BAKEY
BH-3830
30 cm

De Bakey Diş



Toothing De Bakey

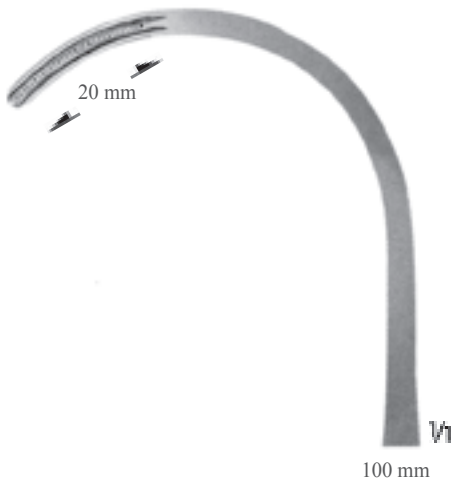

DE BAKEY
BH-3835
26.5 cm



DE BAKEY
BH-3837
27 cm





De Bakey Diş



Toothing De Bakey

2 x 3 sıra diş



2 x 3 teeth rows



DE BAKEY

- BH-3425** 25 cm
- BH-3430** 30 cm
- BH-3431** 31.5 cm
- BH-3433** 33 cm



- BH-3425** 95 mm
- BH-3430** 110 mm
- BH-3431** 130 mm
- BH-3433** 140 mm



BH-5780
23.5 mm

BH-5790
24.5 mm



ALLENBERG

BH-5780 - BH-5790

Anastomoz sırasında ince dokuların ayrılmasında kullanılan bıçaklı ayırıcılar
With retraction blades for retraction of soft tissue during the anastomosis

De Bakey Diş



Toothing De Bakey

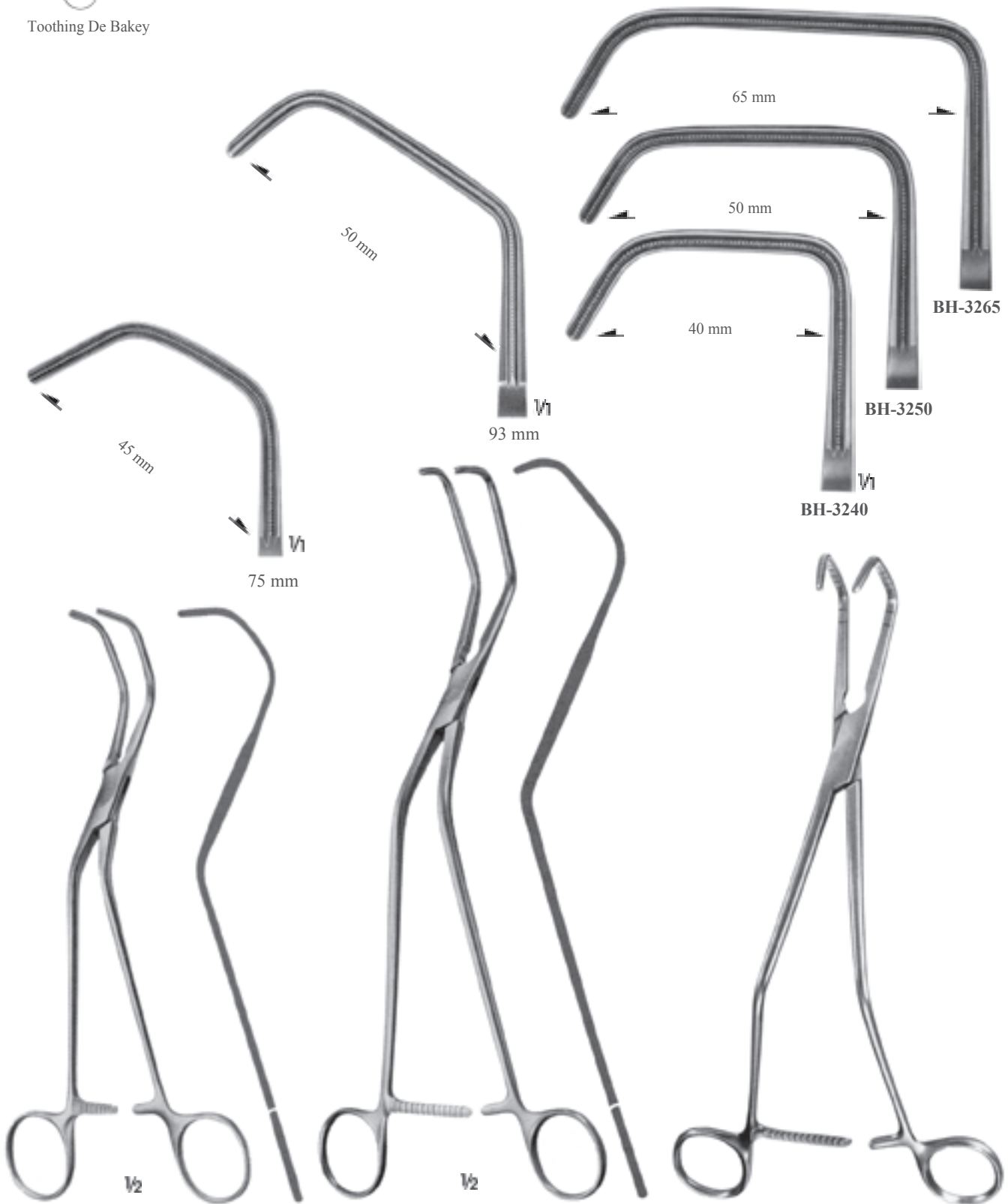

DIETRICH
BH-3905
Aort klem/Aorta clamp
21 cm

OCHSNER
BH-3906
Aort klem/Aorta clamp
26 cm

HOPT
BH-3240 23 cm
BH-3250 23.5 cm
BH-3265 24.5 cm
Böbrek ve Pankreas klempleri
Kidney and Pancreas clamps



De Bakey Diş



Toothing De Bakey

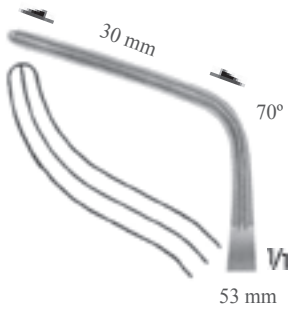

SUBRAMANIAN
BH-4760
15.5 cm

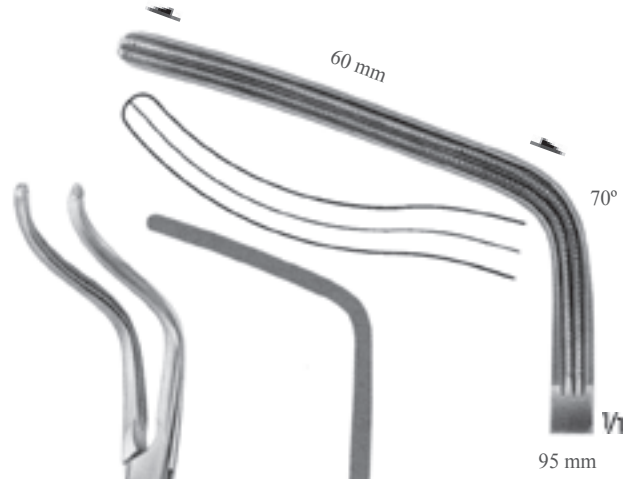

DE BAKEY
BH-4765
26.5 cm

De Bakey Diş



Toothing De Bakey

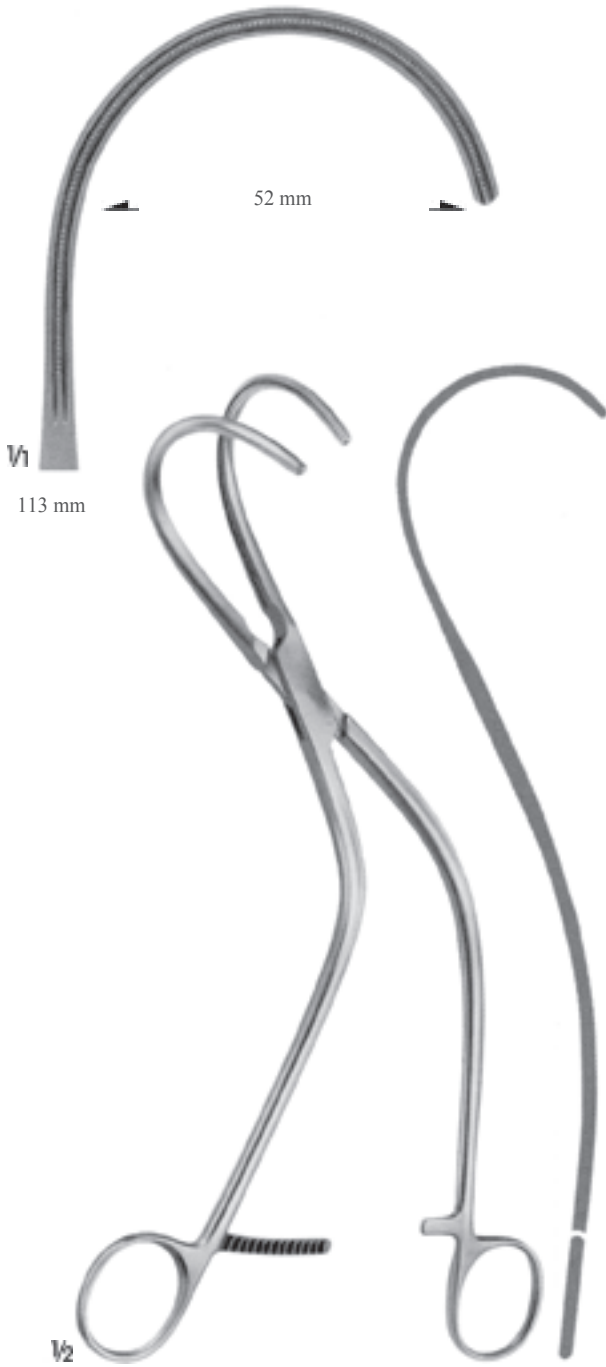

WEBER
BH-3900
Sol/Left
26 cm



WEBER
BH-3901
Sağ/Right
26 cm





De Bakey Diş



Toothing De Bakey

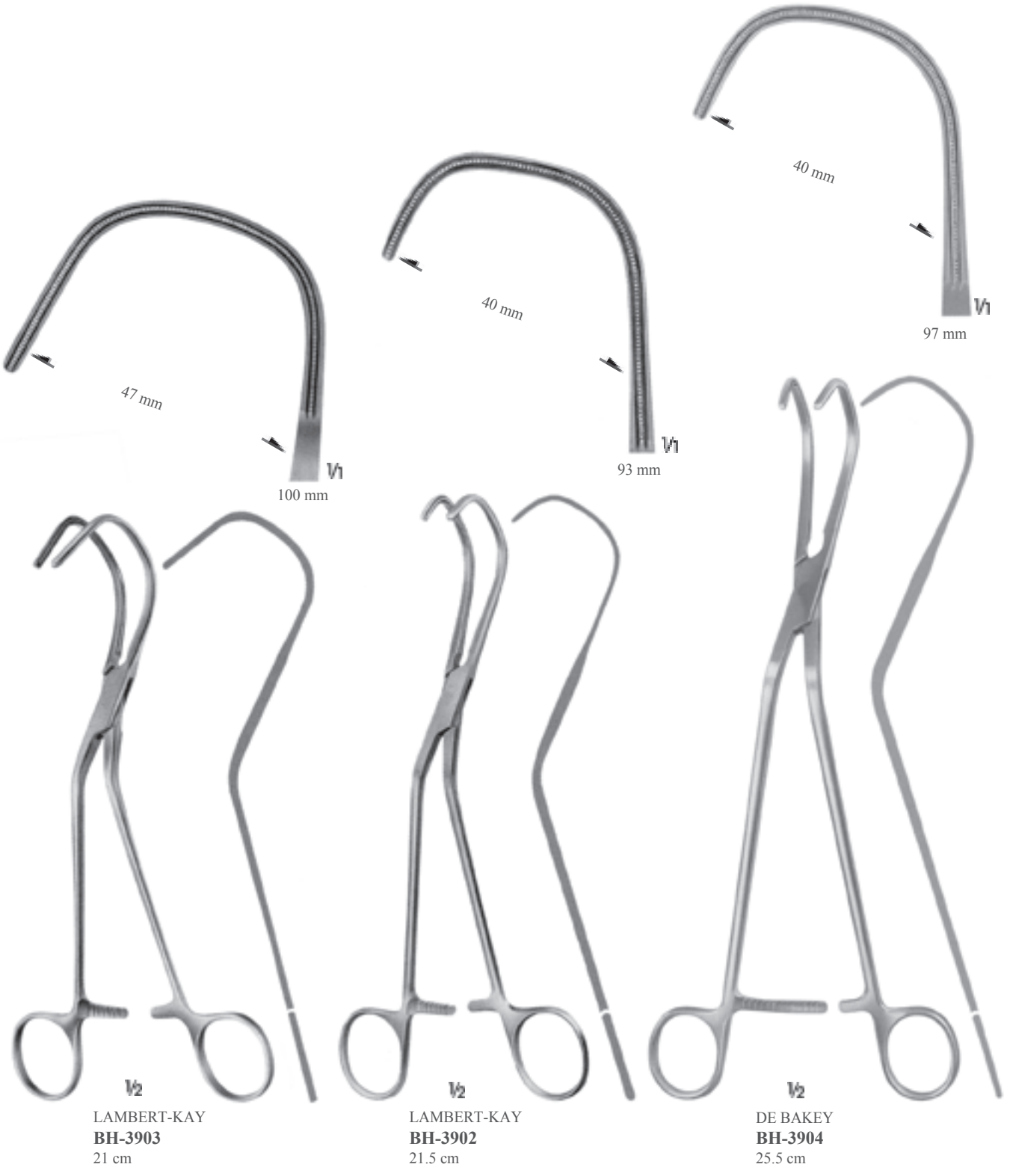

**LAMBERT-KAY
BH-3903**
21 cm

**LAMBERT-KAY
BH-3902**
21.5 cm

**DE BAKEY
BH-3904**
25.5 cm

De Bakey Diş



Toothing De Bakey



LEES
BH-4730
22 cm



LEES
BH-4750
24.5 cm



DE BAKEY-MC QUIGG-MIXTER
BH-3100
21 cm





De Bakey Diş



Toothing De Bakey



GREGORY
BH-2900 57 mm
BH-2901 62 mm
Profunda klempler
Profunda clamps
20 cm



BH-3051
51 mm

BH-3075
75 mm

DE BAKEY
BH-3051 21 cm
BH-3075 23 cm



BH-3077
77 mm

BH-3080
80 mm

DE BAKEY
BH-3077 19 cm
BH-3080 23 cm

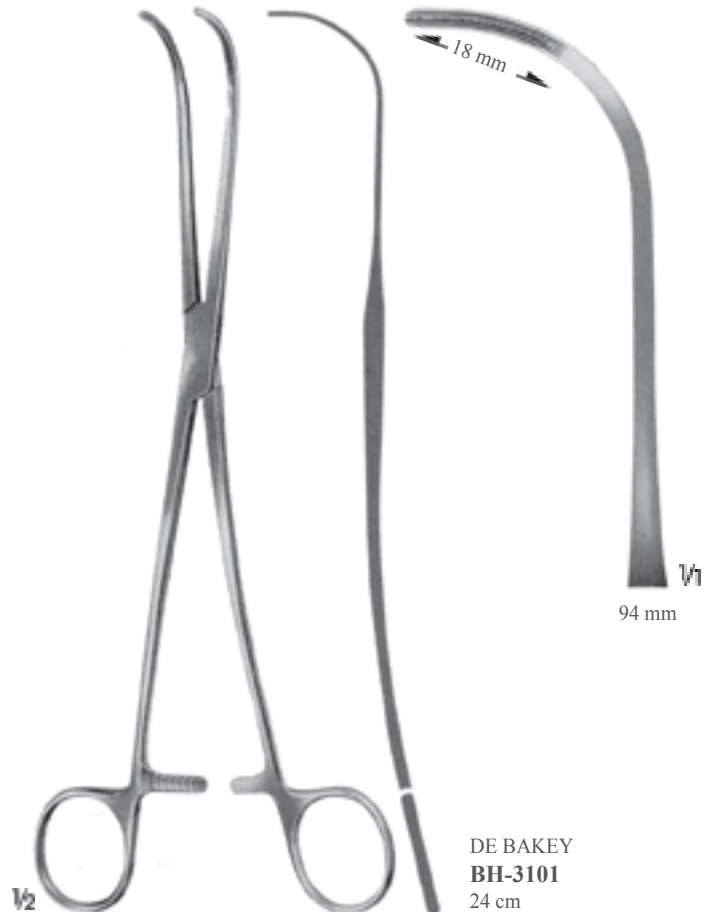

DE BAKEY
BH-3101
24 cm



De Bakey Diş



Toothing De Bakey



81 mm



81 mm



80 mm



DE BAKEY-RUMEL
BH-3103
25 cm



DE BAKEY-RUMEL
BH-3102
24.5 cm



DE BAKEY-MIXTER
BH-3301
28.5 cm





De Bakey Diş



Toothing De Bakey



BH-2180
80 mm



BH-2160
60 mm



BH-2078
78 mm

BH-2088
88 mm

BH-2098
98 mm



BH-2160 - BH-2180
Bronş pensler
Bronchus forceps
23 cm



DICK
BH-2078 25.5 cm
BH-2088 26.5 cm
BH-2098 27.5 cm
Anastomoz klempler
Anastomosis clamps



De Bakey Diş
2 x 3 sıra diş



2 x 3 teeth rows
Toothing De Bakey

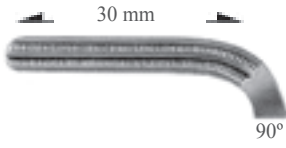

BH-6001
38 mm

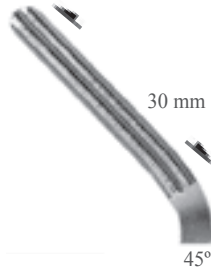

BH-6003
38 mm

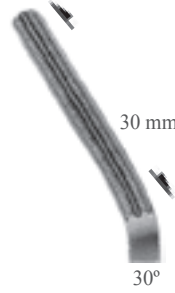

BH-6005
38 mm



BH-6007
38 mm

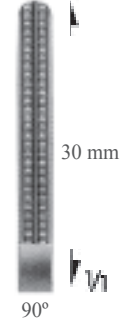

BH-6009
38 mm

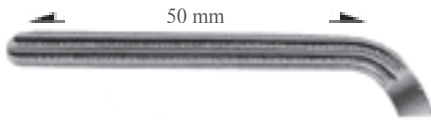

BH-6002
58 mm

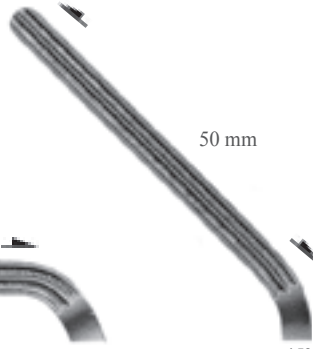

BH-6004
58 mm

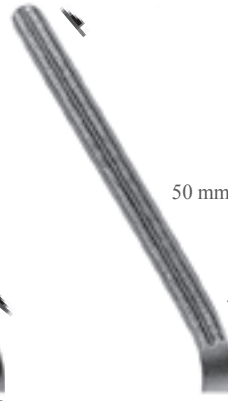

BH-6006
58 mm

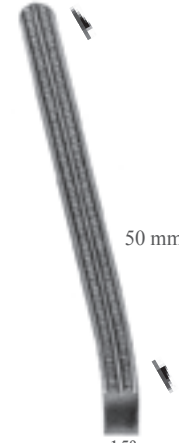

BH-6008
58 mm

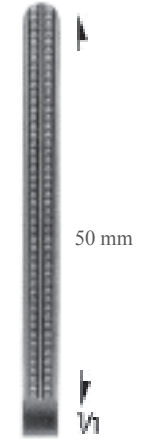

BH-6010
58 mm



DARDIK
BH-6001 13 cm
BH-6003 14.5 cm
BH-6005 15 cm
BH-6007 15 cm
BH-6009 15 cm

DARDIK
BH-6002 13.5 cm
BH-6004 16 cm
BH-6006 17 cm
BH-6008 17 cm
BH-6010 17 cm





Cooley Diş



Toothing Cooley

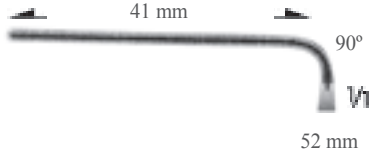

COOLEY
BH-5200
10 cm



COOLEY
BH-5201 12 cm
BH-5202 12.5 cm
BH-5203 12.5 cm

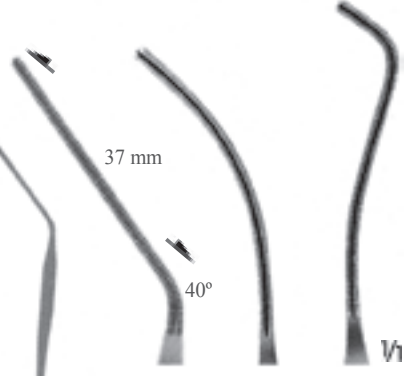

BH-5201 50 mm
BH-5202 50 mm
BH-5203 52 mm



COOLEY
BH-5200 12.5 cm
BH-5201 11.5 cm

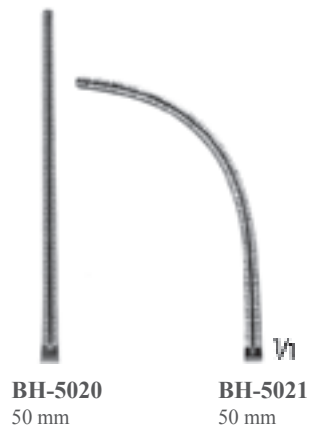

BH-5200 50 mm
BH-5201 50 mm



COOLEY
BH-5202
12.5 cm



15°
50 mm

Cooley Diş



Toothing Cooley

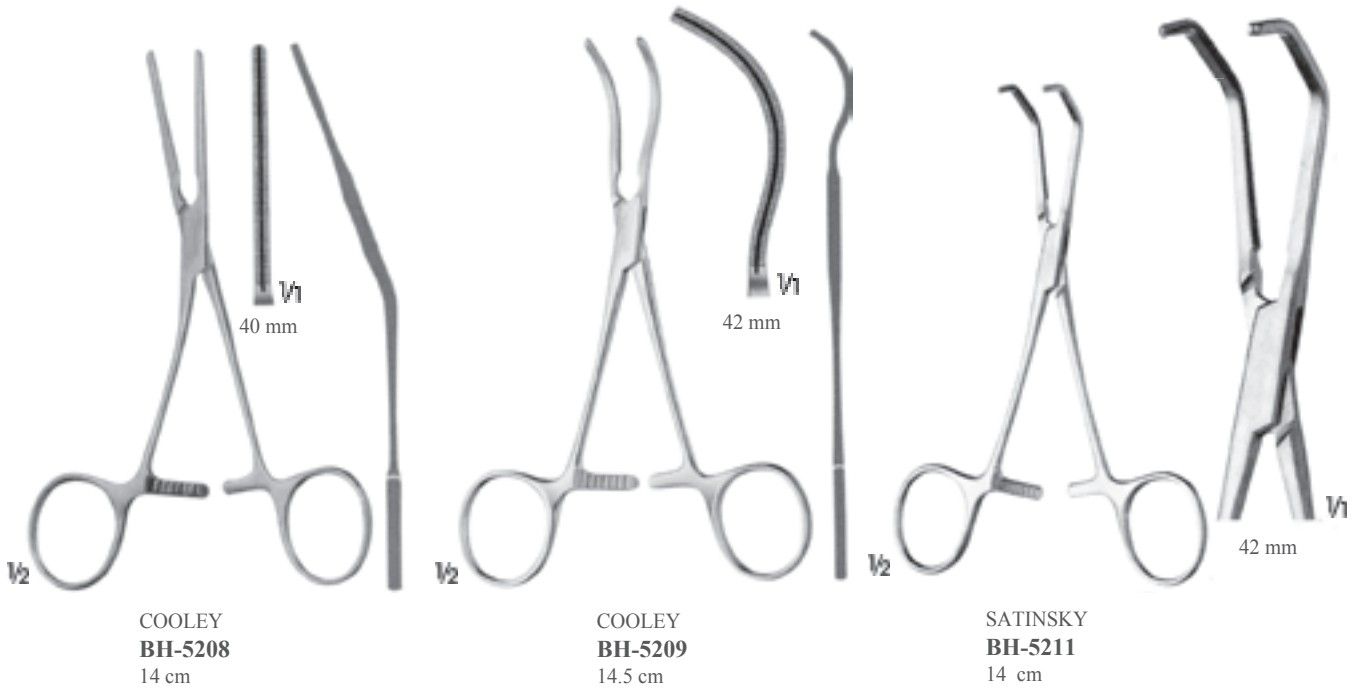

COOLEY
BH-5208
14 cm

COOLEY
BH-5209
14.5 cm

SATINSKY
BH-5211
14 cm

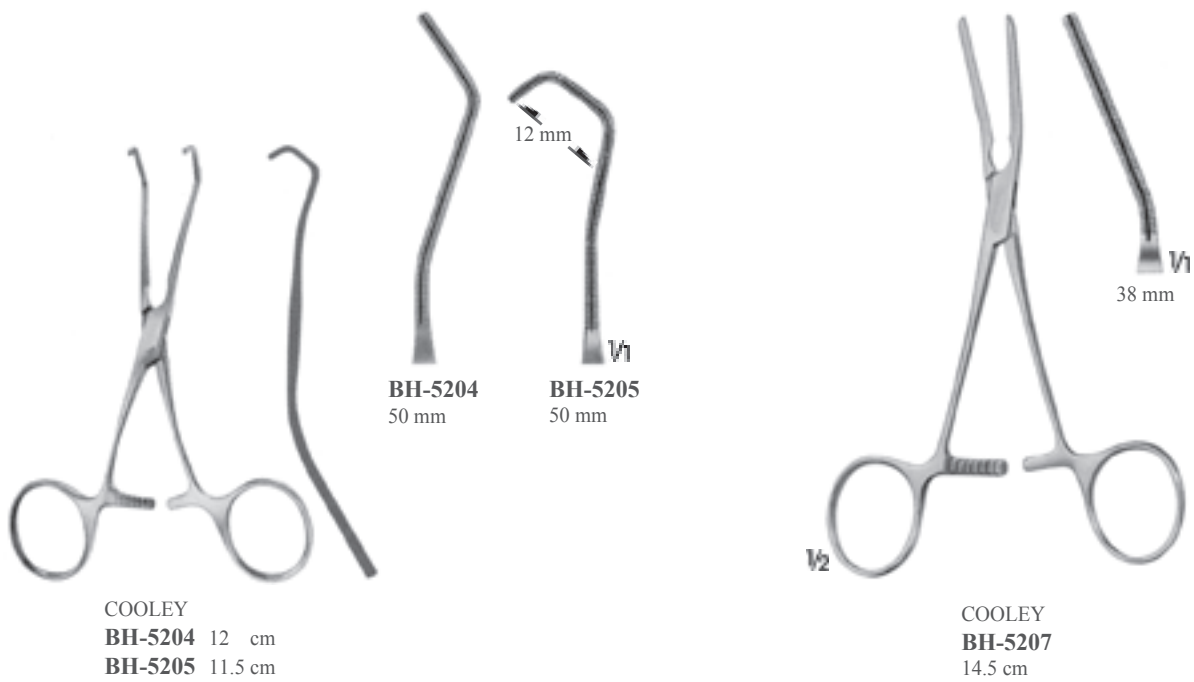

COOLEY
BH-5204 12 cm
BH-5205 11.5 cm

COOLEY
BH-5207
14.5 cm



Cooley Diş



Toothing Cooley



COOLEY-BECK

BH-5500 15 cm

BH-5501 15.5 cm



BH-5500
56 mm

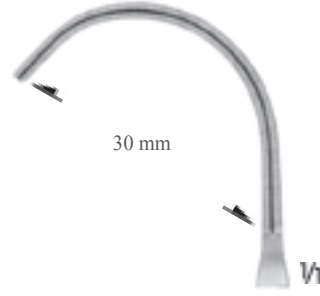

BH-5501
63 mm



COOLEY

BH-5511 - BH-5512

17 cm

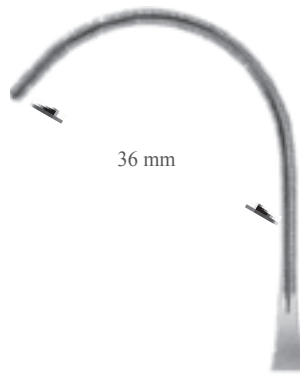

BH-5511
82 mm

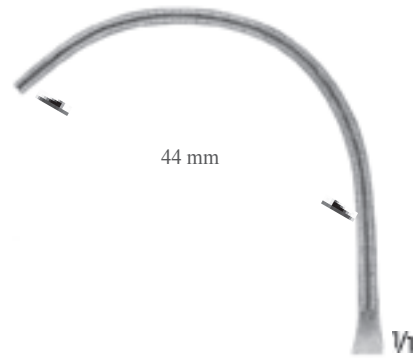

BH-5512
82 mm

Cooley Diş



Toothing Cooley

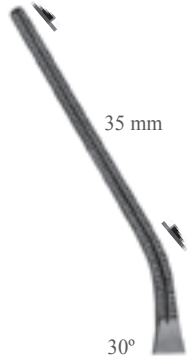

BH-5548
48 mm

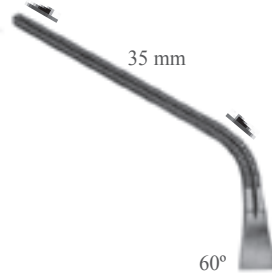

BH-5547
52 mm

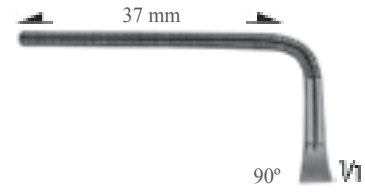

BH-5546
56 mm

COOLEY

BH-5546 15 cm

BH-5547 16 cm

BH-5548 16.5 cm

Çok amaçlı klempler/Multi Purpose clamps

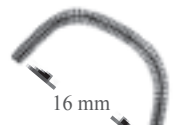

BH-5520
71 mm

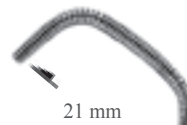

BH-5521
76 mm



BH-5522
80 mm

DERRA-COOLEY

BH-5520 17 cm

BH-5521 17.5 cm

BH-5522 17.5 cm

Anastomoz klempler/Anastomosis clamps





Cooley Diş



Toothing Cooley

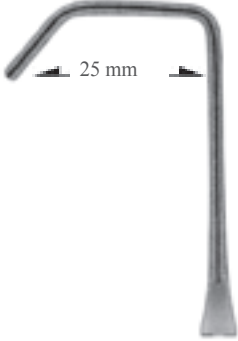

BH-5530
72 mm

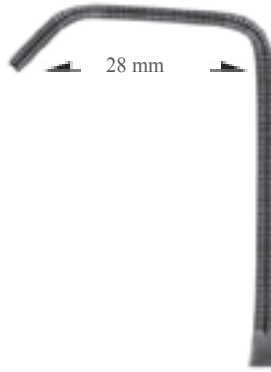

BH-5531
76 mm

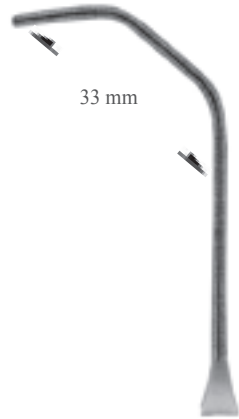

BH-5532
72 mm

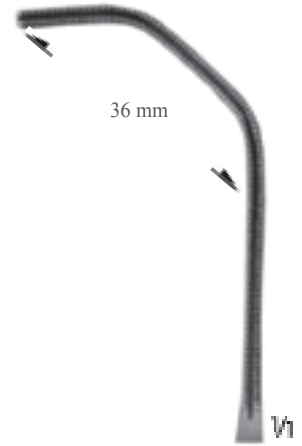

BH-5533
76 mm



COOLEY
BH-5530 16.5 cm
BH-5531 16.5 cm
BH-5532 17.5 cm
BH-5533 18 cm

Cooley Diş



Toothing Cooley

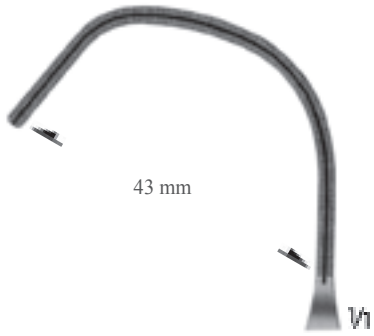

43 mm

V1

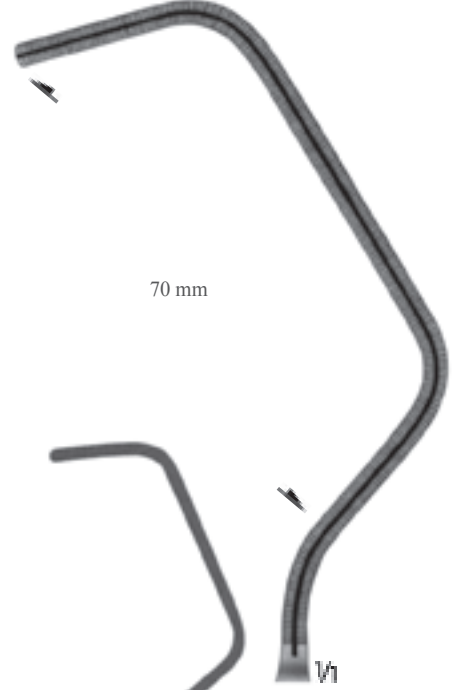

70 mm

V1



V2

LEITZ
BH-5550
20.5 cm



V2

PARRY-COOLEY
BH-5560
29.5 cm





Cooley Diş



Toothing Cooley

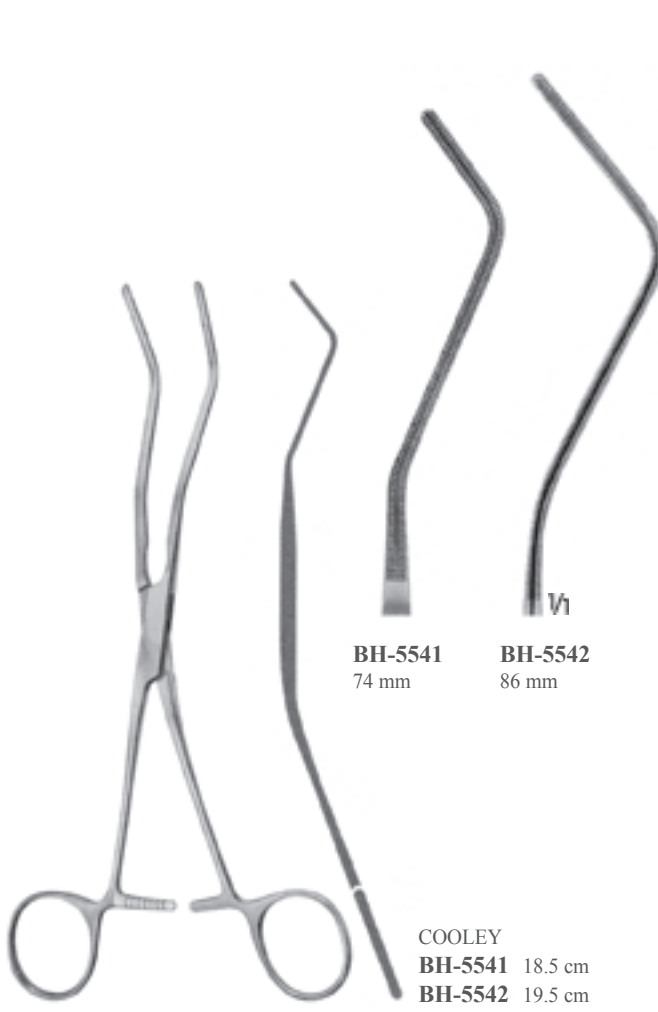
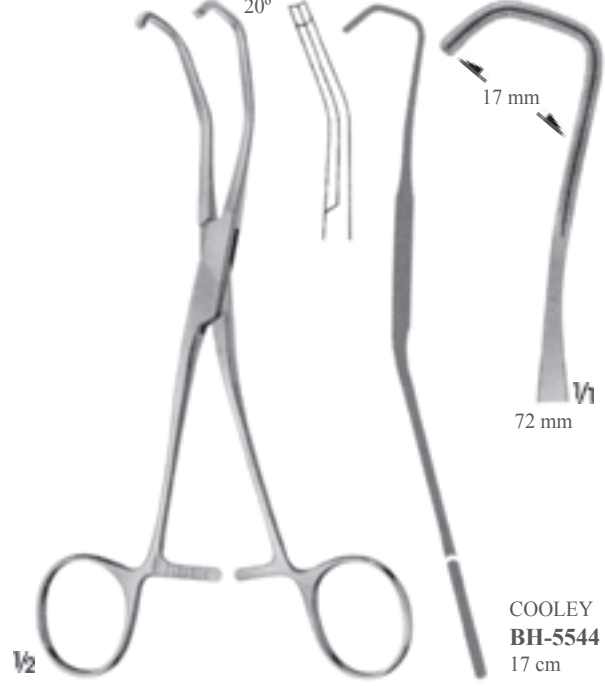
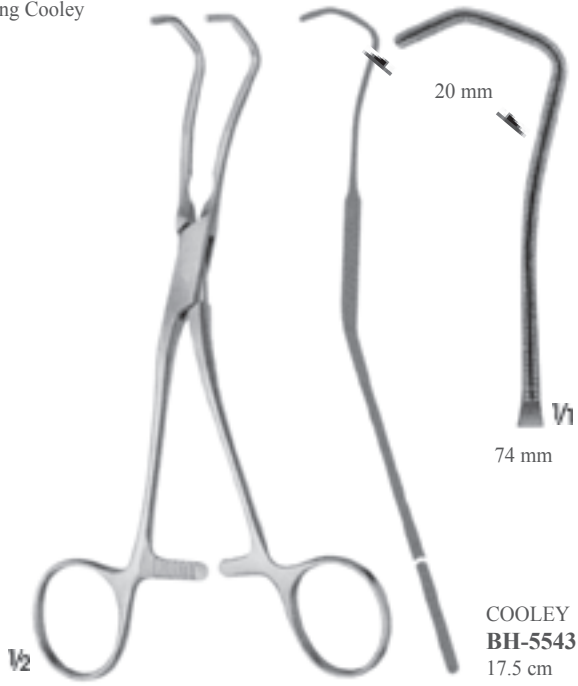

Cooley Diş



Toothing Cooley

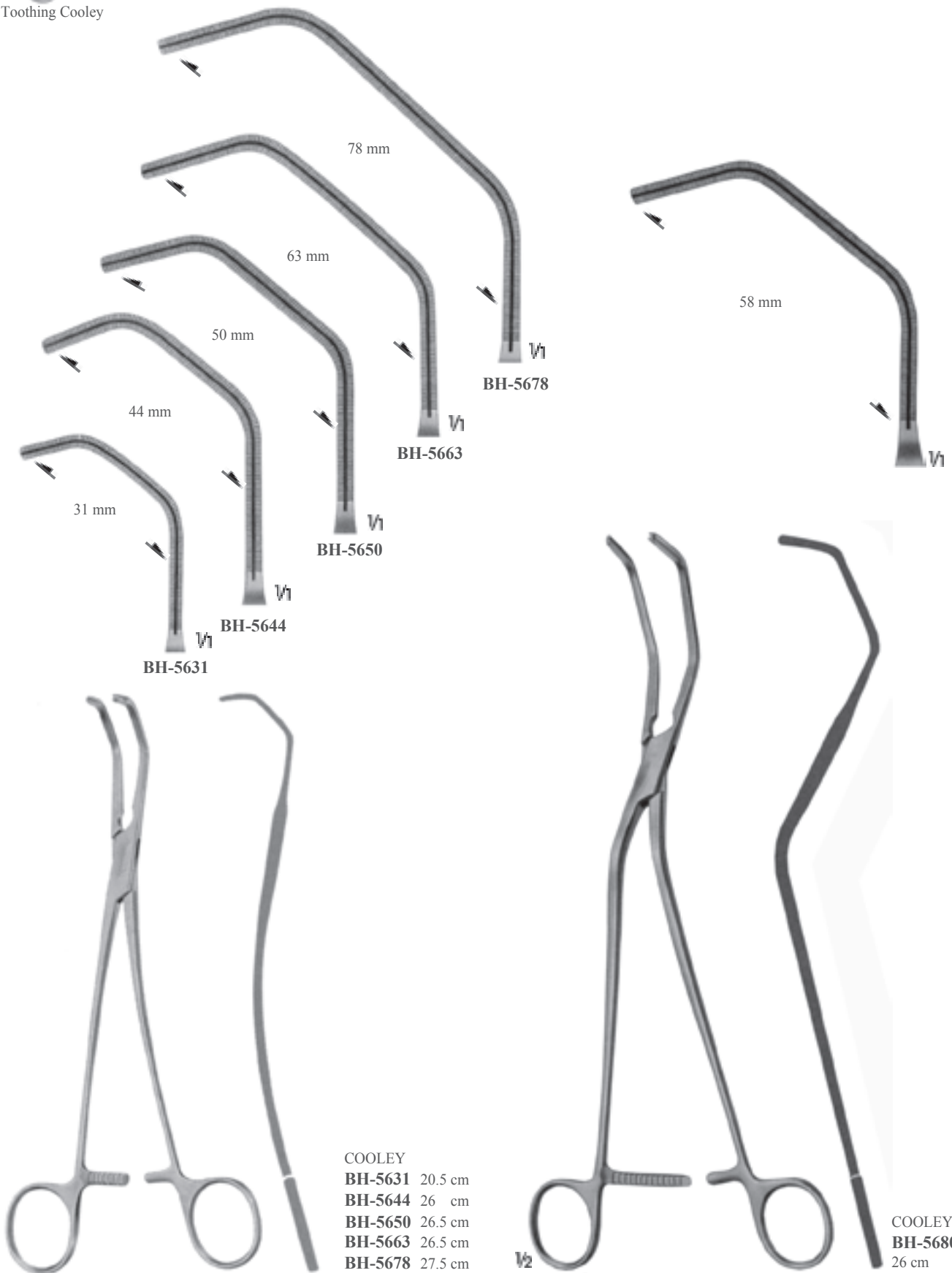

COOLEY
BH-5631 20.5 cm
BH-5644 26 cm
BH-5650 26.5 cm
BH-5663 26.5 cm
BH-5678 27.5 cm

COOLEY
BH-5680
 26 cm



Cooley Diş



Toothing Cooley



COOLEY
BH-5701 16 cm
BH-5702 17 cm



BH-5701 41 mm
BH-5702 52 mm

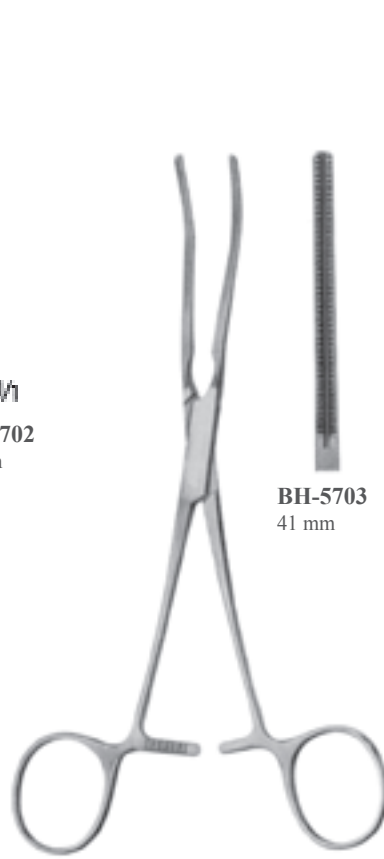

COOLEY
BH-5703 16 cm
BH-5704 17 cm
BH-5705 18 cm
BH-5706 18 cm

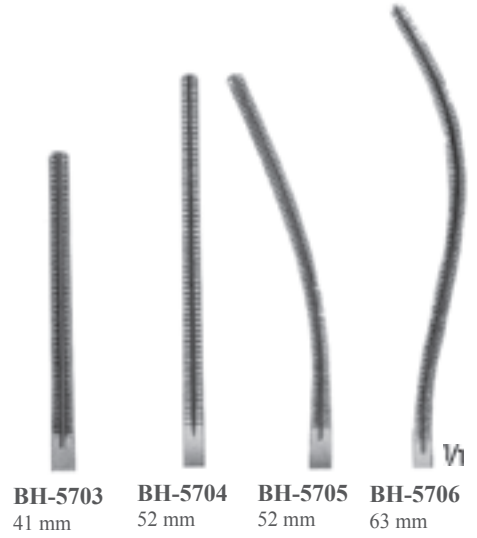

BH-5703 41 mm
BH-5704 52 mm
BH-5705 52 mm
BH-5706 63 mm

Cooley Diş



Toothing Cooley

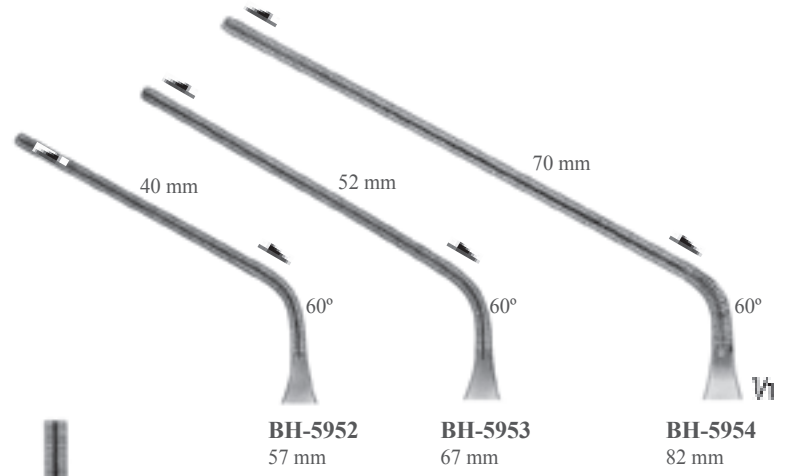

BH-5950
68 mm

BH-5951
75 mm

BH-5950 22.5 cm
BH-5951 27 cm



BH-5952 16.5 cm
BH-5953 17 cm
BH-5954 18.5 cm





Cooley Diş



Toothing Cooley

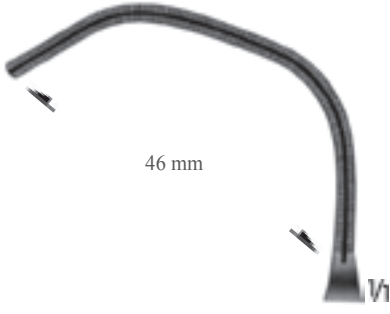

46 mm

V1



V2

COOLEY
BH-5940
22 cm



82 mm

V1



V2

COOLEY
BH-5941
28.5 cm

Cooley Diş



Toothing Cooley



COOLEY
BH-5942
32 cm



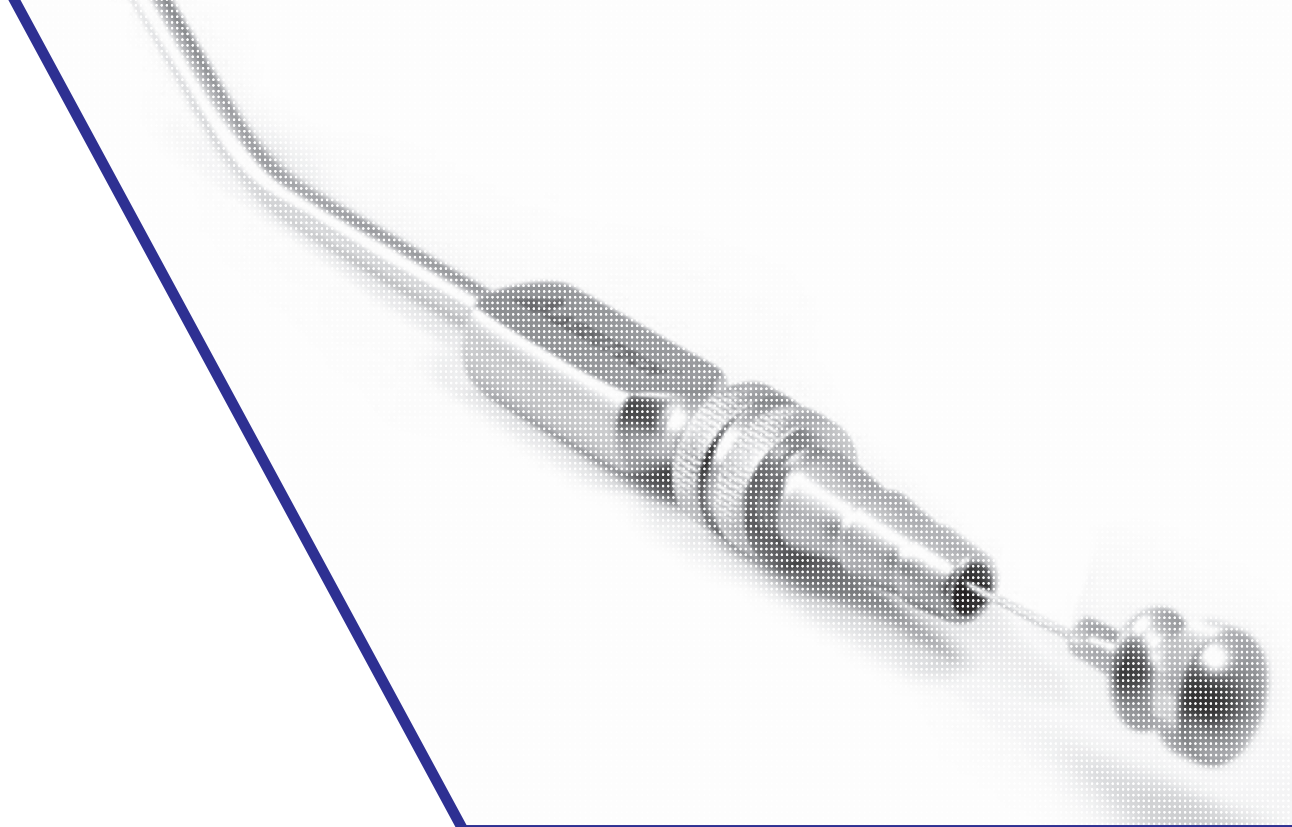

BJ

Sondalar, Aspiratör Uçları, Trokarlar ve Biyopsi İğneleri
Probes, Suction Tubes, Trocars and Biopsy Needles



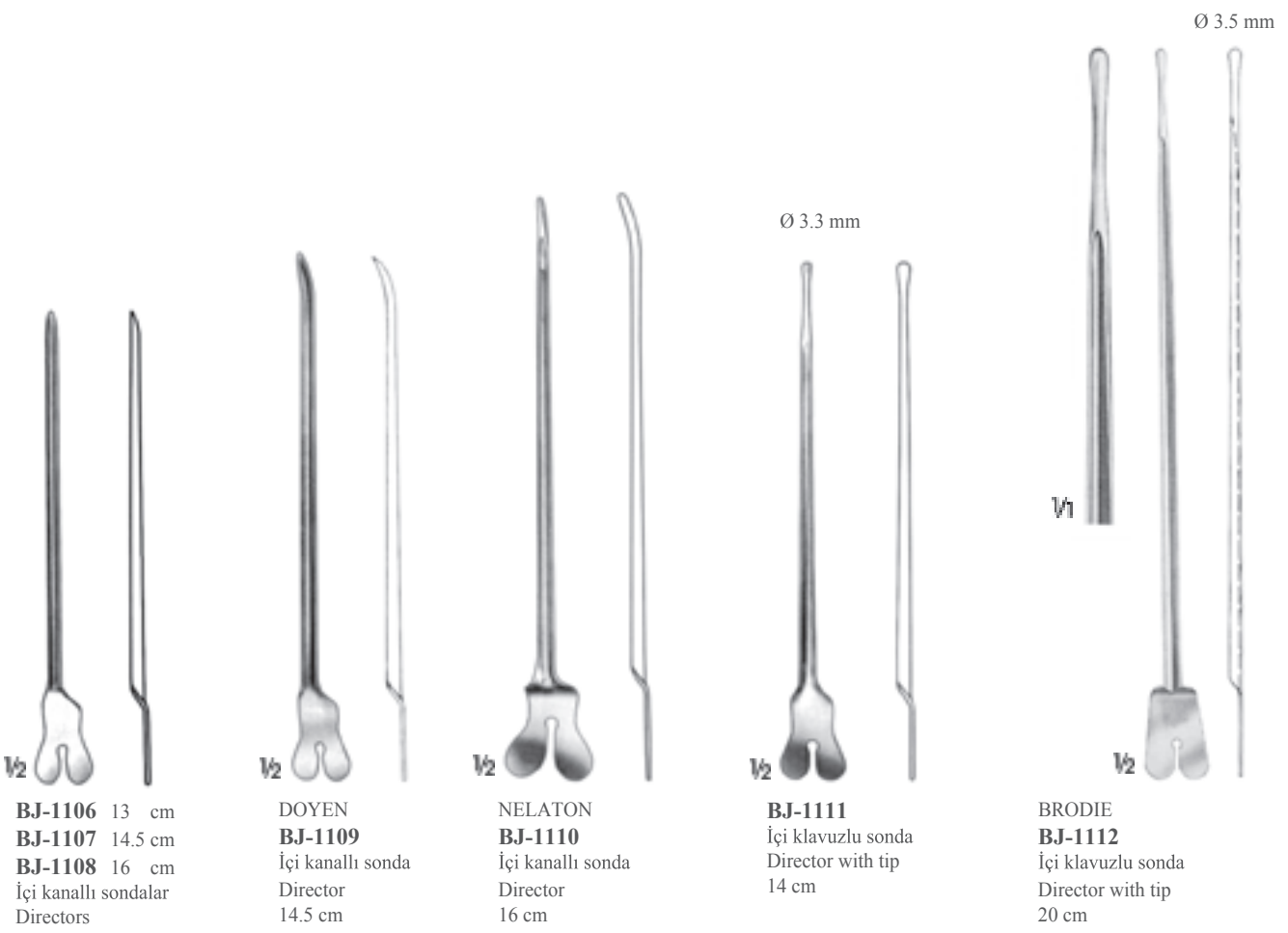

BJ-1106 13 cm
BJ-1107 14.5 cm
BJ-1108 16 cm
İçer kanallı sondalar
Directors

DOYEN
BJ-1109
İçer kanallı sonda
Director
14.5 cm

NELATON
BJ-1110
İçer kanallı sonda
Director
16 cm

Ø 3.3 mm
BJ-1111
İçer klavuzlu sonda
Director with tip
14 cm

Ø 3.5 mm
BJ-1112
İçer klavuzlu sonda
Director with tip
20 cm

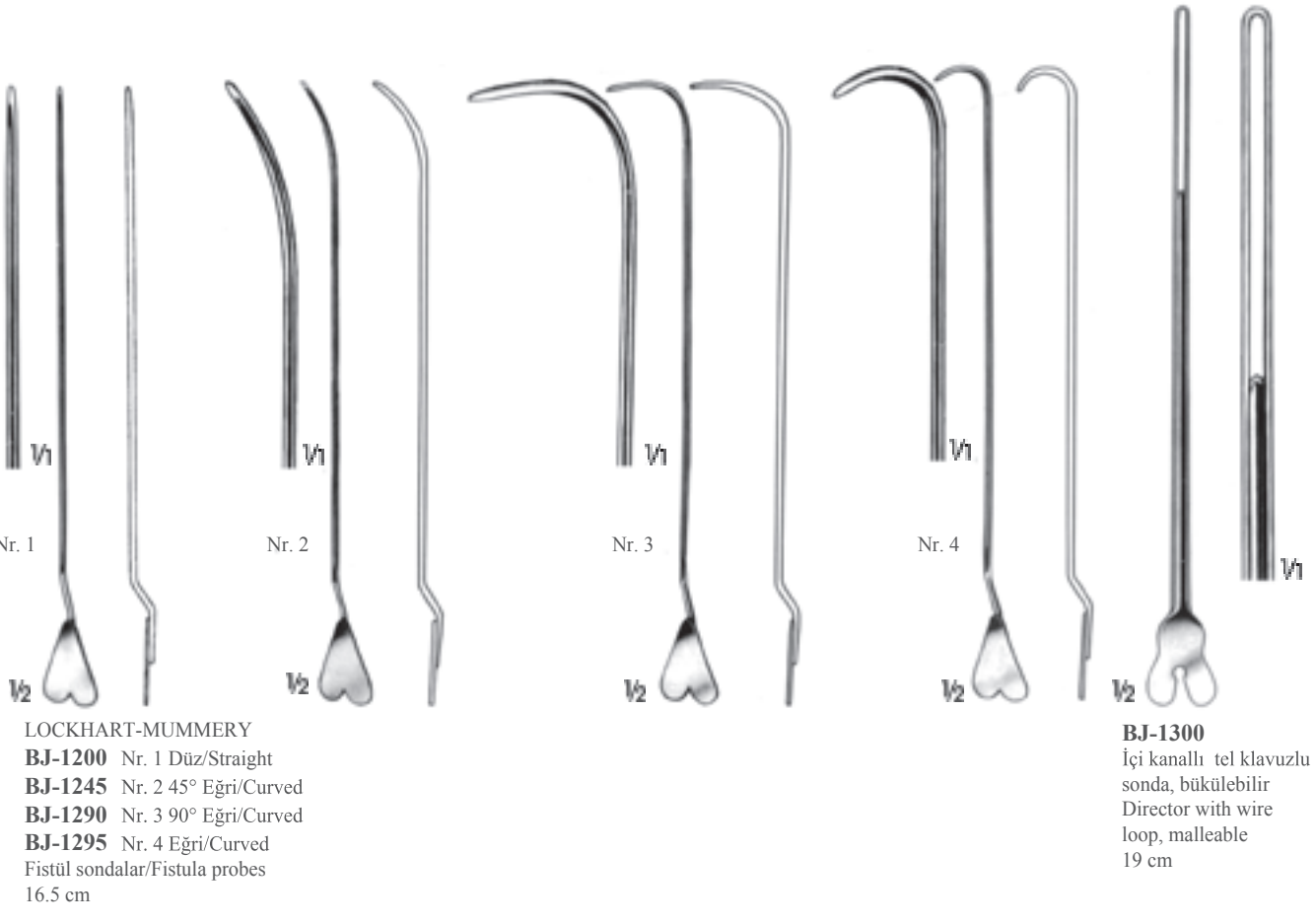

LOCKHART-MUMMERY
BJ-1200 Nr. 1 Düz/Straight
BJ-1245 Nr. 2 45° Eğri/Curved
BJ-1290 Nr. 3 90° Eğri/Curved
BJ-1295 Nr. 4 Eğri/Curved
Fistül sondalar/Fistula probes
16.5 cm

BJ-1300
İçer kanallı tel klavuzlu
sonda, bükülebilir
Director with wire
loop, malleable
19 cm

Ø 2.0 mm



BJ-1413 13 cm
BJ-1414 14.5 cm
BJ-1416 16 cm
BJ-1418 18 cm
BJ-1420 20 cm
 Mirtle yaprak sondalar
 Myrtle leaf probes

Ø 1.5 mm



BJ-1450
 Mirtle yaprak sonda
 Myrtle leaf probe
 14.5 cm



BJ-1630 Ø 2.0 mm
 14.5 cm
BJ-1635 Ø 2.5 mm
 16 cm
BJ-1640 Ø 3.0 mm
 20 cm
 Delikli sondalar
 Probes with eye

Uç çapı

Diameter of tip

Uç çapı	Diameter of tip	Uzunluk	Length
1 mm	1.5 mm	2 mm	13 cm
-	BJ-1601	-	14.5 cm
BJ-1600	BJ-1602	BJ-1607	16 cm
-	BJ-1603	BJ-1608	18 cm
-	BJ-1604	BJ-1609	20 cm
-	BJ-1605	BJ-1610	25 cm
-	BJ-1606	-	30 cm
-	-	BJ-1612	30 cm

BJ-1600 - BJ-1612
 Sondalar/Probes

Ø 3.5 mm



BJ-1725 25 cm
BJ-1730 30 cm
 Çift başlı sondalar
 bükülebilir, delikli
 Double ended probes,
 malleable, with hole

Ø 4.0 mm



BJ-1740
 Çift başlı sonda
 bükülebilir
 Double ended probe,
 malleable
 40 cm

Ø 2.0 mm



BJ-1801
 Sonda/Probe
 30 cm

Ø 1.2 mm



BJ-1800
 Sinus sonda
 Sinus probe
 15 cm

Ø 3.0 mm



BJ-1719
 Çift başlı sonda
 bükülebilir, delikli
 Double ended probe,
 malleable, with hole
 19 cm





KINGS'S COLLEGE HOSPITAL
BJ-1804
Pamuk aplikatör
Cotton applicator
Sert burgulu
Rough, spiral end
9 cm



STACKE
BJ-1802
Sonda/Probe
Gümüş/Silver
10 cm

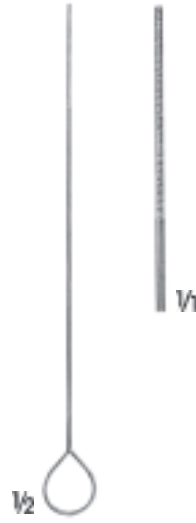

KINGS'S COLLEGE HOSPITAL
BJ-1805
Pamuk aplikatör
Cotton applicator
Sert burgulu
Rough, spiral end
13.5 cm



CAWTHORNE
BJ-1806
Sonda/Probe
Yaprak uçlu, gümüş
Flattened end silver
14 cm



BOWMAN
BJ-1900 Ø 0.7 + 0.8 mm
BJ-1901 Ø 0.9 + 1.1 mm
BJ-1902 Ø 1.3 + 1.4 mm
BJ-1903 Ø 1.5 + 1.6 mm
BJ-1904 Ø 1.8 + 1.9 mm
Sondalar/Probes
Gümüş/Silver
13 cm

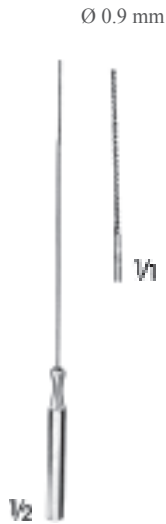

BUCK
BJ-1910
Pamuk aplikatör
Cotton applicator
Ucu sert burgulu
Rough, spiral end
12 cm



BJ-1803
Sonda/Probe
16 cm



SEIFFERT
BJ-1807
Sonda/Probe
Gümüş/Silver
19.5 cm



KILLIAN
BJ-1808
Sonda/Probe
16.5 cm



**FARRELL
BJ-2214**
Ucu yuvarlak tırtıllı
Round serrated end
14 cm



**LATHBURY-FARRELL
BJ-2314**
Ucu üçgen tırtıllı
Triangular serrated end
14 cm



**LATHBURY-FARRELL
BJ-1915**
Ucu üçgen tırtıllı
Triangular serrated end
14 cm



BJ-2010
Ucu sert burgulu
Rough, spiral end
14 cm



BJ-2012
Ucu sert burgulu
Rough, spiral end
14 cm



BJ-2015
Ucu sert burgulu
Rough, spiral end
18 cm



**FARRELL
BJ-2216**
Ucu sert burgulu
Rough, spiral end
16 cm



**LATHBURY-FARRELL
BJ-2317**
Ucu üçgen tırtıllı
Triangular serrated end
16 cm

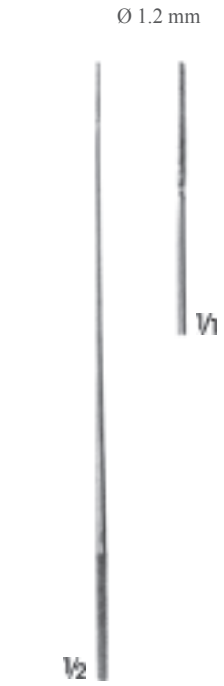

**LATHBURY-FARRELL
BJ-2316**
Ucu üçgen tırtıllı
Triangular serrated end
16 cm



BJ-2018
Ucu sert burgulu
Rough, spiral end
18 cm



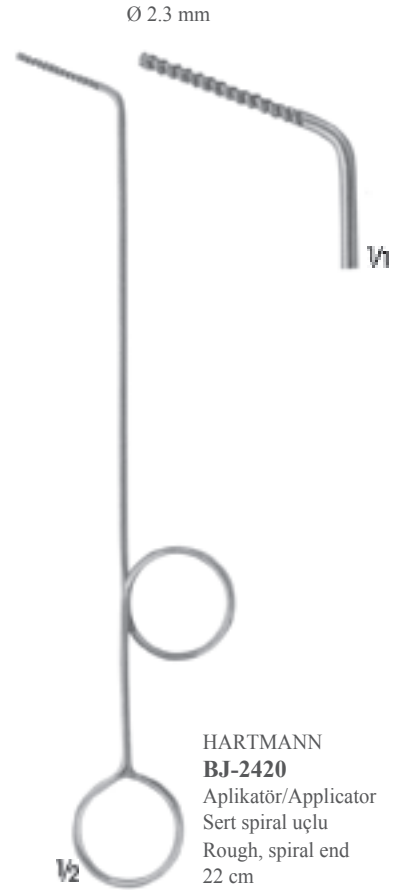



FERGUSSON					
Çalışma boyu Working length	11 cm	13 cm	16 cm	20 cm	
Tam boy Total Length	18 cm	21.5 cm	24.5 cm	28 cm	Ø
	BJ-3715	BJ-3815	BJ-3915	BJ-4015	1.5 mm
	BJ-3720	BJ-3820	BJ-3920	BJ-4020	2.0 mm
	BJ-3725	BJ-3825	BJ-3925	BJ-4025	2.5 mm
	BJ-3730	BJ-3830	BJ-3930	BJ-4030	3.0 mm
	BJ-3740	BJ-3840	BJ-3940	BJ-4040	4.0 mm
	BJ-3750	BJ-3850	BJ-3950	BJ-4050	5.0 mm

Parmak kumandalı, temizleme telli
parmak basma yüzeyi yatay LUER bağlantı
With finger cut-of and styled
Thumb piece 90° to curve, With LUER hub

Olive
Ø 6-9 mm



FERGUSSON
BJ-4240 Ø 4 mm
İzoleli, parmak kumandalı,
temizleme telli
parmak basma yüzeyi yatay
LUER bağlantı
Isolated, with finger cut-of and stylet,
thumb piece 90° to curve, with LUER
hub
18 cm

Olive
Ø 6-9 mm



FRAZIER
BJ-4430 Ø 3 mm
BJ-4450 Ø 5 mm
Parmak kumandalı, temizleme
telli parmak basma yüzeyi
yatay LUER bağlantı
With finger cut-of and stylet
Thumb piece 90° to curve,
with LUER hub
18 cm

FRAZIER
BJ-4323 Ø 2.3 mm
BJ-4327 Ø 2.7 mm
BJ-4334 Ø 3.4 mm
BJ-4340 Ø 4.0 mm
Parmak kumandalı, temizleme
telli parmak basma yüzeyi yatay
LUER bağlantı
With finger cut-of and stylet
Thumb piece 90° to curve,
with LUER hub
11 cm





ZOELLNER

- BJ-1504** Ø 26 swg, Ø 0.4 mm
- BJ-1505** Ø 24 swg, Ø 0.5 mm
- BJ-1507** Ø 22 swg, Ø 0.7 mm
- BJ-1510** Ø 20 swg, Ø 1.0 mm
- BJ-1512** Ø 18 swg, Ø 1.2 mm

BJ-8422 ve BJ-8423 için sökülüp takılabilir uçlar
Detachable ends fitting to BJ-8422 and BJ-8423
10'luk paket/Package of 10 pieces



VERHOEVEN

- BJ-8940** Ø 24 swg, Ø 0.5 mm
- BJ-8941** Ø 22 swg, Ø 0.7 mm
- BJ-8942** Ø 20 swg, Ø 1.0 mm
- BJ-8943** Ø 18 swg, Ø 1.2 mm
- BJ-8944** Ø 16 swg, Ø 1.5 mm

Aspiratör ucu, LUER koniği
Suction cannulae with Luer cone
10 cm

Olive
Ø 7 mm



HOUSE

BJ-8475

Parmak kumandalı emiş adaptörü LUER koniği, LUER bağlantılı
Suction adapter with finger cut-off, LUER cone, LUER hub
5.5 cm



PLESTER

- BJ-3215** Ø 1.5 mm
- BJ-3220** Ø 2.0 mm
- BJ-3225** Ø 2.5 mm
- BJ-3230** Ø 3.0 mm

Parmak kumandalı, temizleme telli parmak basma yüzeyi baş parmağa paralel LUER bağlantı
With finger cut-off and stylet, thumb piece parallel to curve, with LUER hub
19.5 cm

Olive
Ø 6-9 mm

Ø 4 mm



Olive
Ø 9 mm

ADSON

BJ-4140

Parmak kumandalı
With finger cut-off
19 cm

Ø 3 mm

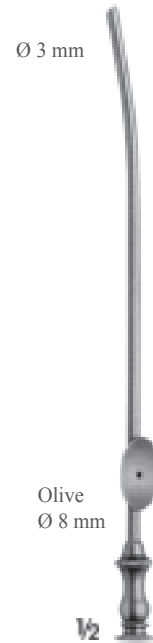

Olive
Ø 8 mm

ADSON

BJ-5430

Aspiratör ucu
Suction cannula
Parmak kumandalı ve temizleme telli
With finger cut-off and stylet
16.5 cm



GILLIES
BJ-4730 Ø 3 mm
Parmak kumandalı ve
temizleme telli
With finger cut-off and stylet
17 cm



LEMPERT
BJ-4520 Ø 2 mm
BJ-4530 Ø 3 mm
Parmak kumandalı ve
temizleme telli
With finger cut-off and stylet
20 cm



FORMBY
BJ-4633 Ø 3.3 mm
21 cm



Olive
Ø 6-8 mm

BJ-6050 Komple/Complete
BJ-6001 Sap/Handle
BJ-6005 Ø 0.5 mm
BJ-6007 Ø 0.7 mm
BJ-6010 Ø 1.0 mm
BJ-6013 Ø 1.3 mm
LUER koni/With LUER cone



Olive
Ø 6-8 mm

WULLSTEIN
BJ-6150 Komple/Complete
BJ-6100 LUER bağlantılı sap
handle with LUER hub
BJ-6104 Ø 0.4 mm
BJ-6106 Ø 0.6 mm
BJ-6108 Ø 0.8 mm



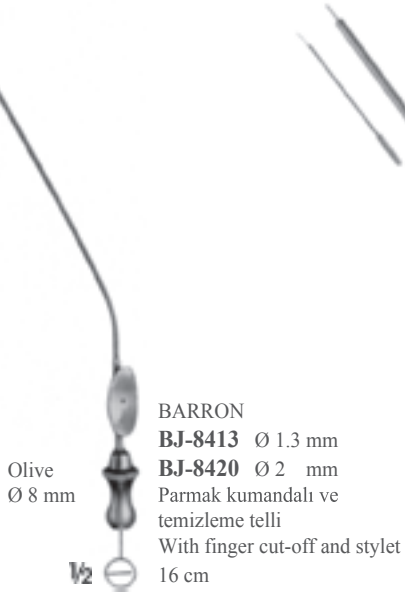

BARRON
BJ-8413 Ø 1.3 mm
BJ-8420 Ø 2 mm
Parmak kumandalı ve temizleme telli
With finger cut-off and stylet
16 cm

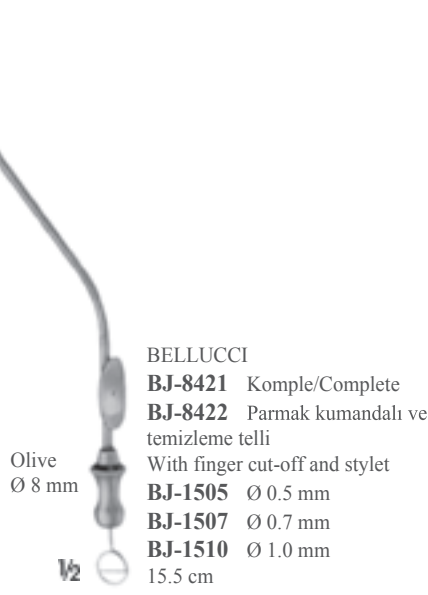

BELLUCCI
BJ-8421 Komple/Complete
BJ-8422 Parmak kumandalı ve temizleme telli
With finger cut-off and stylet
BJ-1505 Ø 0.5 mm
BJ-1507 Ø 0.7 mm
BJ-1510 Ø 1.0 mm
15.5 cm

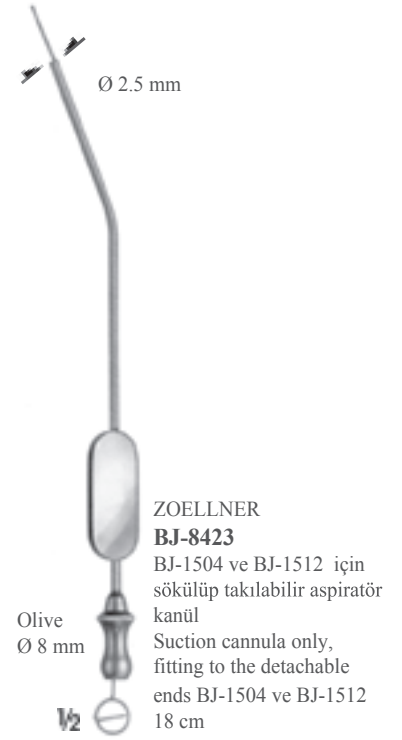

ZOELLNER
BJ-8423
BJ-1504 ve BJ-1512 için sökülüp takılabilir aspiratör kanül
Suction cannula only, fitting to the detachable ends BJ-1504 ve BJ-1512
18 cm



WULLSTEIN
BJ-8190
Aspiratör ucu konik şeklinde gümüş
Suction tube conical, silver
LUER bağlantılı With LUER hub
16 cm

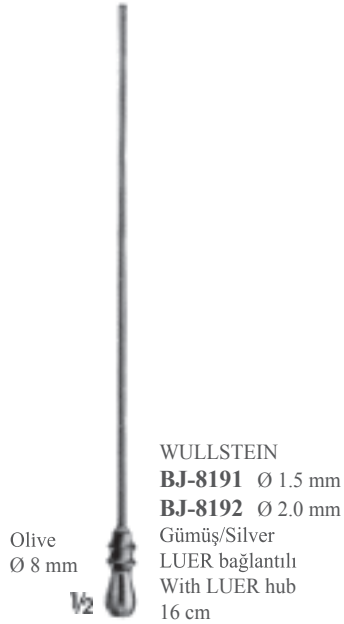

WULLSTEIN
BJ-8191 Ø 1.5 mm
BJ-8192 Ø 2.0 mm
Gümüş/Silver LUER bağlantılı With LUER hub
16 cm



SCHUKNECHT
BJ-8310 Ø 1 mm
BJ-8305 Ø 0.5 mm
Aspiratör ucu Suction cannula
13 cm

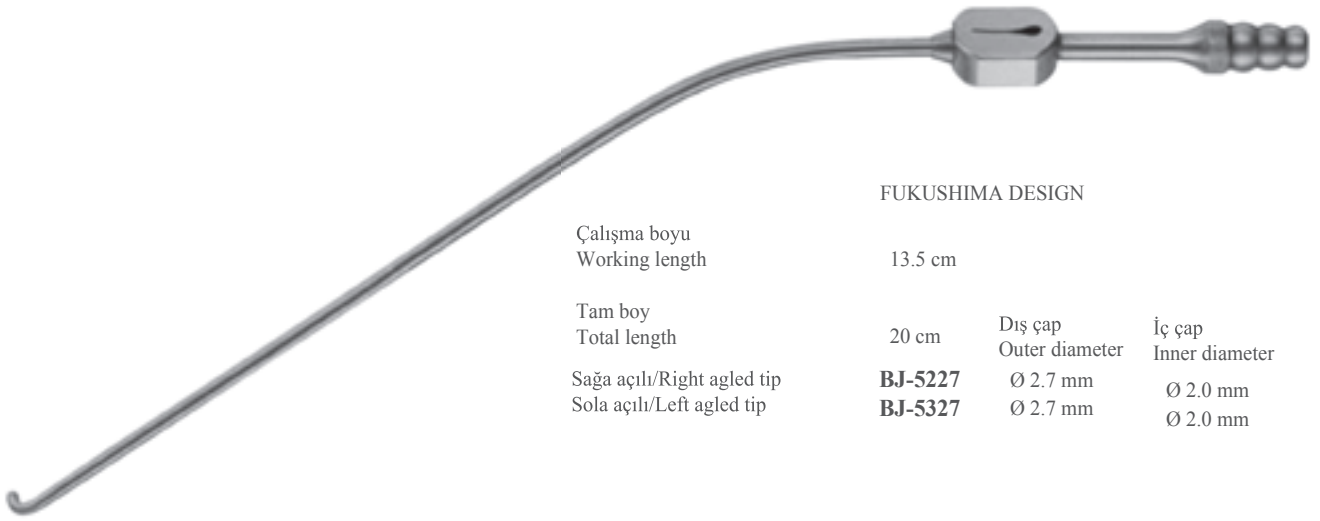

FUKUSHIMA DESIGN

Çalışma boyu
Working length

13.5 cm

Tam boy
Total length

20 cm

Sağa açılı/Right angled tip
Sola açılı/Left angled tip

BJ-5227

BJ-5327

Dış çap
Outer diameter

Ø 2.7 mm

Ø 2.7 mm

İç çap
Inner diameter

Ø 2.0 mm

Ø 2.0 mm

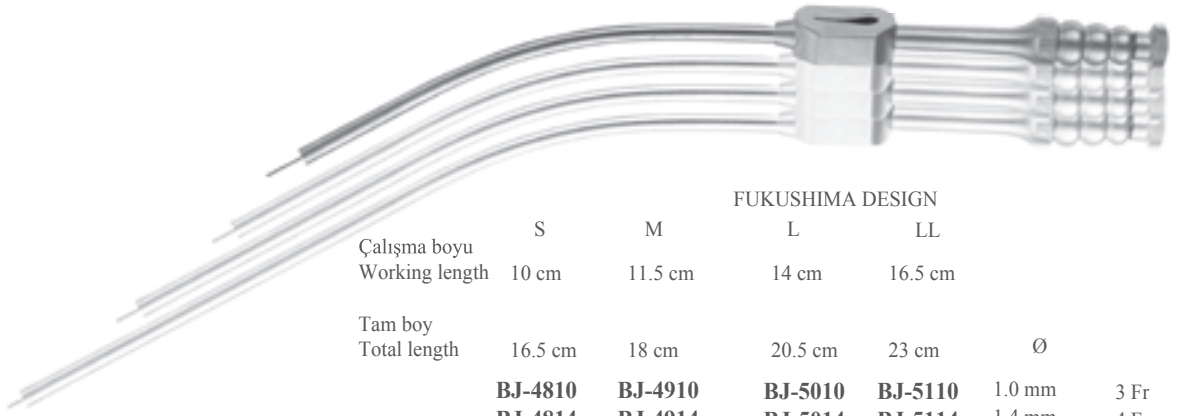

FUKUSHIMA DESIGN

Çalışma boyu
Working length

S

M

L

LL

10 cm

11.5 cm

14 cm

16.5 cm

Tam boy
Total length

16.5 cm

18 cm

20.5 cm

23 cm

Ø

BJ-4810

BJ-4910

BJ-5010

BJ-5110

1.0 mm

3 Fr

BJ-4814

BJ-4914

BJ-5014

BJ-5114

1.4 mm

4 Fr

BJ-4817

BJ-4917

BJ-5017

BJ-5117

1.7 mm

5 Fr

BJ-4820

BJ-4920

BJ-5020

BJ-5120

2.0 mm

6 Fr

BJ-4823

BJ-4923

BJ-5023

BJ-5123

2.3 mm

7 Fr

BJ-4827

BJ-4927

BJ-5027

BJ-5127

2.7 mm

8 Fr

BJ-4830

BJ-4930

BJ-5030

BJ-5130

3.0 mm

9 Fr

BJ-4840

BJ-4940

BJ-5040

BJ-5140

4.0 mm

12 Fr

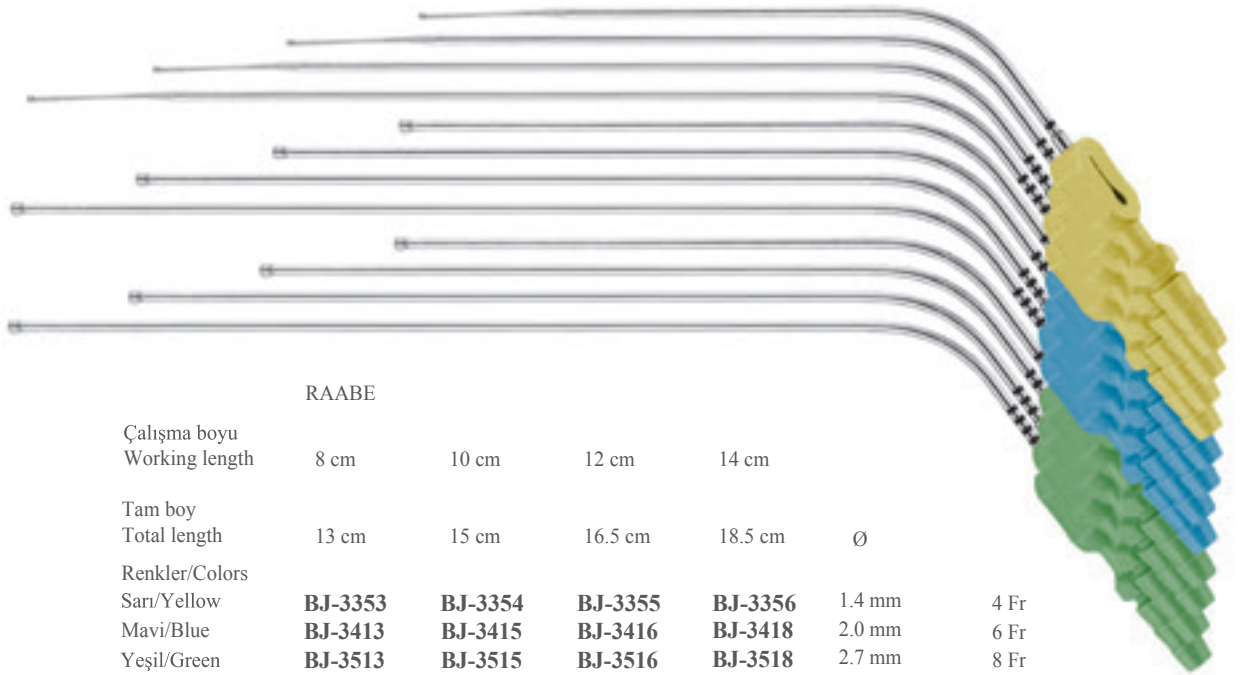

RAABE

Çalışma boyu
Working length

8 cm

10 cm

12 cm

14 cm

Tam boy
Total length

13 cm

15 cm

16.5 cm

18.5 cm

Ø

Renkler/Colors

Sarı/Yellow

BJ-3353

BJ-3354

BJ-3355

BJ-3356

1.4 mm

4 Fr

Mavi/Blue

BJ-3413

BJ-3415

BJ-3416

BJ-3418

2.0 mm

6 Fr

Yeşil/Green

BJ-3513

BJ-3515

BJ-3516

BJ-3518

2.7 mm

8 Fr



BJ-8892

Parmak kumandalı ve temizleme telli
With finger cut-off and stylet

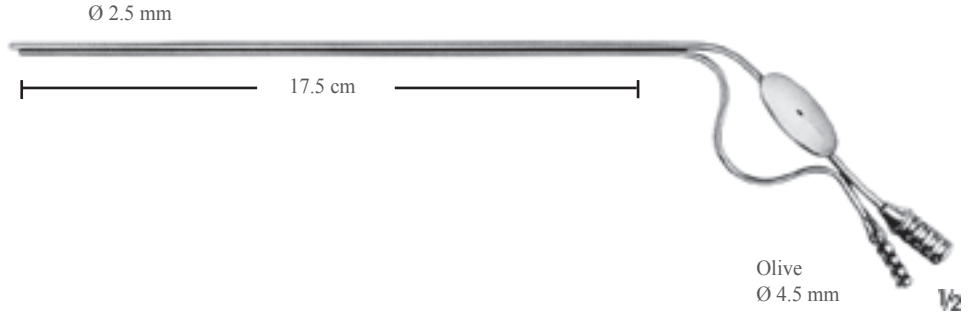

BJ-8011 Ø 2.0 mm

BJ-8012 Ø 2.5 mm

BJ-8013 Ø 3.0 mm

Parmak kumandalı ve temizleme telli
parmak basma yüzeyi yatay
With finger cut-off, thumb piece 90° to curve
25 cm



HOUSE

BJ-8900 Ø 0.9 - 0.7 mm

BJ-8901 Ø 1.2 - 0.9 mm

BJ-8902 Ø 1.5 - 1.2 mm

Parmak kumandalı ve temizleme telli
With finger cut-off and stylet

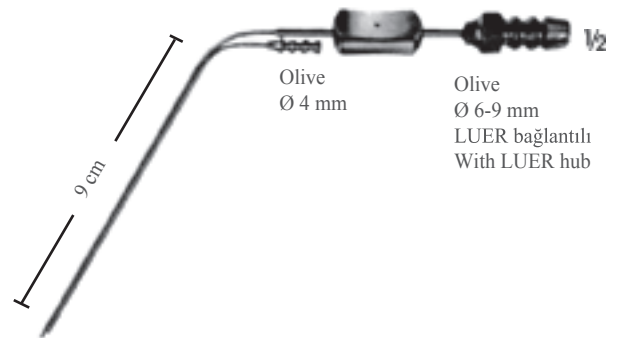

BJ-8204 4 mm

BJ-8205 5 mm

Aspiratör raspa, sivri bayonet tip
Suction raspatories, sharp
bayonet-shaped
20 cm



LANDOLT

BJ-8206 Genişlik/Wide 3.2 mm

Hipofizektomi ve Kbb için aspiratör ucu,
keskin açılı nokta
Dissecting suction tube for hypophysectomie
and ENT, sharp angled point
20 cm



BJ-8185

Uç genişliği 6,5 mm
Tip wide 6.5 mm
Burun aspiratör ucu, LUER bağlantılı
Nasal suction tube, with LUER hub
18 cm



GORNEY

BJ-8209

Aspiratör disektör
Suction dissector
18 cm



NEGUS

BJ-8208

Aspiratör disektör
Suction dissector
21 cm



LOPEZ-REINKE

BJ-8207

Aspirasyonlu Tonsil disektör
Tonsil dissector with suction
device
23.5 cm



YASARGIL

BJ-8891

Kanül/Cannula
LUER-LOC koniği
LUER-LOC cone
20 cm





YASARGIL

Aspiratör uçları/Suction tubes

BJ-7013 Ø 1.5 mm	BJ-7015 Ø 1.5 mm	BJ-7018 Ø 1.5 mm	BJ-7022 Ø 1.5 mm
BJ-7113 Ø 2.0 mm	BJ-7115 Ø 2.0 mm	BJ-7118 Ø 2.0 mm	BJ-7122 Ø 2.0 mm
BJ-7213 Ø 2.5 mm	BJ-7215 Ø 2.5 mm	BJ-7218 Ø 2.5 mm	BJ-7222 Ø 2.5 mm
BJ-7313 Ø 3.5 mm	BJ-7315 Ø 3.5 mm	BJ-7318 Ø 3.5 mm	BJ-7322 Ø 3.5 mm
		BJ-7418 Ø 4.5 mm	
13 cm	15 cm	18 cm	22 cm

Olive
Ø 6.5-9 mm

LUER bağlantılı
With LUER hub

Ø 3,5 mm

Ø 2,0 mm

BJ-8001 50 cm

BJ-8002 35 cm

Aspiratör uçları/Suction tubes

Lastik uçlu

With rubber tip

Olive
Ø 6-9 mm

LUER bağlantılı
With LUER hub



ROWBOTHAM
BJ-8436
Kanül/Cannula
29.5 cm



MAGILL
BJ-8433 Ø 3.0 mm
BJ-8434 Ø 3.5 mm
BJ-8435 Ø 4.0 mm
Magil emiş kanülü
Styilet for magill suction tubes
24.5 cm

BJ-8426

Büyük miktarda sıvı temizlemek için
For clearing large quantities of fluid
19 cm

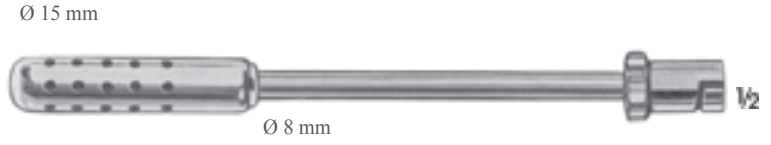

BJ-8428

Delmek için trokar
Trocar, for puncturing
17 cm



BJ-8429

Regülatör ve parmak kumandalı
aspiratör adaptörü
Suction handle, with vacuum regulator
and finger cut-off, brass, mirror-finish
chromium-plated
15 cm



BJ-8427

Çift eğimli genel cerrahi için
Double curved, for general surgery
23 cm



BJ-8437

Ø 9 mm
Üniversal çift eğimli kanül
Universal cannula, double curved
23 cm



POOL

BJ-8438

Aspiratör kanülü, vidalanabilir dış tüpü ile
Suction cannula, with outer tube to be
screwed off
22.5 cm



▲
Ø 10 mm
Charr.30

POOL

BJ-8439

Aspiratör kanülü, vidalanabilir dış tüpü ile
Suction cannula, with outer tube to be
screwed off
22.5 cm



▲
Ø 7 mm
Charr.21





YANKAUER

BJ-8102

Uç kısmı Ø 4.8 mm geniş delikli
With especially large bore 4.8 mm diam
28.5 cm

Olive
Ø 7-9 mm



YANKAUER

BJ-8103

Uç kısmı Ø 2.0 mm delikli
With central bore, 2.0 mm diam
28.5 cm

Olive
Ø 7-9 mm



DE BAKEY

BJ-8106

Uç kısmı Ø 3.0 mm delikli
With central bore, 3.0 mm
diam
27.5 cm

Olive
Ø 6-10 mm



DE BAKEY

BJ-8107

Parmak kumandalı, temizleme telli
With finger cut-off and stylet
27 cm

Olive
Ø 9 mm



DE BAKEY

BJ-8120

Parmak kumandalı, temizleme telli
With finger cut-off and stylet
16 cm

Olive
Ø 9 mm



Ø 15 mm

FINSTERER
BJ-8890
Sulama kanül
Irrigation cannula
32 cm

Olive
Ø 9-13 mm

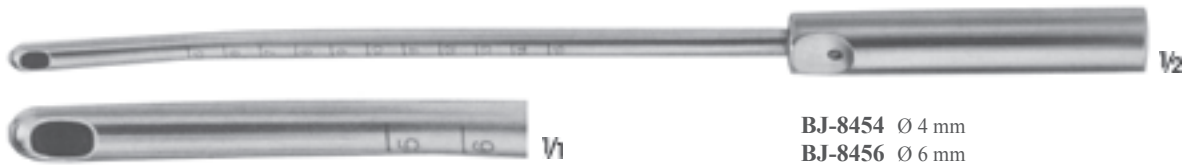

BJ-8454 Ø 4 mm
BJ-8456 Ø 6 mm
BJ-8458 Ø 8 mm
BJ-8460 Ø 10 mm
BJ-8462 Ø 12 mm
BJ-8464 Ø 14 mm
Vakum küreti, vakumlu kürtaj
için emme kanülü
Curettes with graduation and suction
interrupter, for vacuum curettage

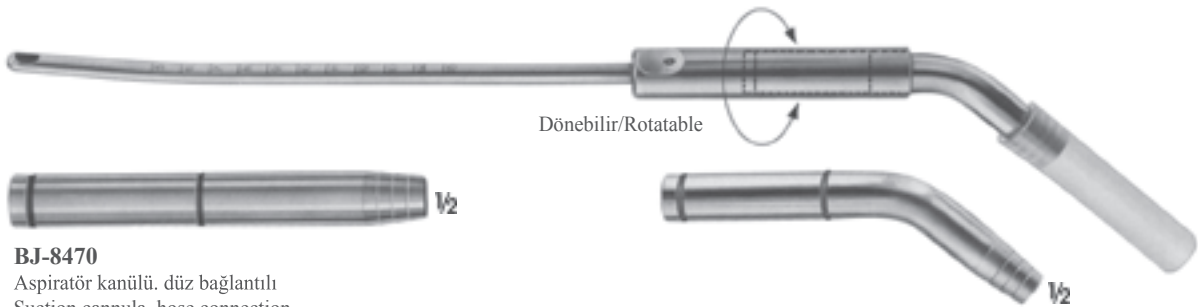

Dönebilir/Rotatable

BJ-8470

Aspiratör kanülü, düz bağlantılı
Suction cannula, hose connection
straight
Ø 11 mm

BJ-8465

Aspiratör kanülü, eğri bağlantılı
Suction cannula, hose connection,
curved
Ø 11 mm

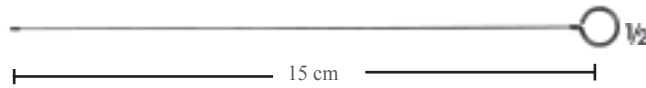

15 cm



Vakum hortumu için bağlantı
Connection for suction hose

Çap/Olive
Ø 7.5-12 mm

LANDOLT

BJ-8903 İzoleli/Insulated
Pıhtı emiş kanülü, mandrenli ve stoplu Ø 5 mm
143° buhar sterilizatörlerinde steril edilebilir.
Coagulation suction cannula
with interrupter and mandrel Ø 5 mm
Can be sterilized in a steam sterilizer up to 143°

HF elektrotları tarafından dokunulmuş,
lekelenmemiş bağlantı Ø 4 mm
HF-Elektrot kolu Ø 4 mm
Untarnished contact to be
touched by HF-electrodes Ø 4 mm



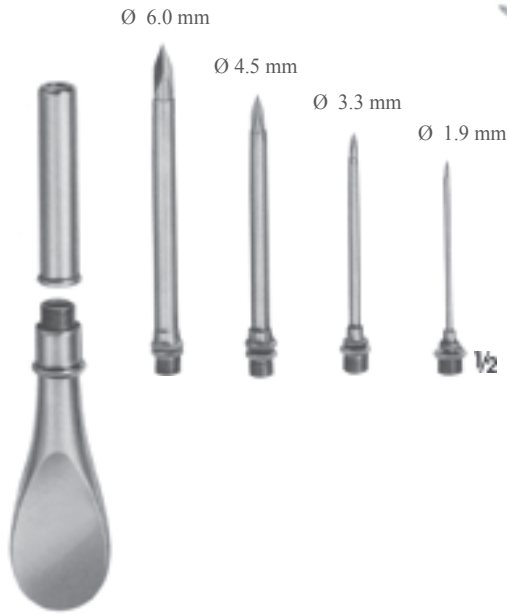

BJ-3600
4 ucu ile birlikte
sökülebilir trokar
Trocar with interchangeable
tips (4 pcs.)



PIERCE
BJ-3601 Ø 4.0 mm
Antrum trokar
Antrum trocar



KRAUSE
BJ-3602 Ø 4.0 mm
Antrum trokar
Antrum trocar



BJ-3900 İç/Inside Ø 2.2 mm Dış/Outside Ø 3.3 mm
BJ-3901 Ø 3.0 mm Ø 4.0 mm
BJ-3902 Ø 4.0 mm Ø 5.0 mm
BJ-3903 Ø 5.0 mm Ø 6.0 mm
Yandan boşaltmalı musluklu, karın
delme trokarı
For abdominal puncture, with
stop-cock and lateral drain.



BJ-3910 100 mm
BJ-3911 110 mm
BUELAU
BJ-3910 İç/Inside Ø 6.5 mm Dış/Outside Ø 8.0 mm
BJ-3911 Ø 9.0 mm Ø 10.0 mm
Ampiyem trokar
Empyema trocar

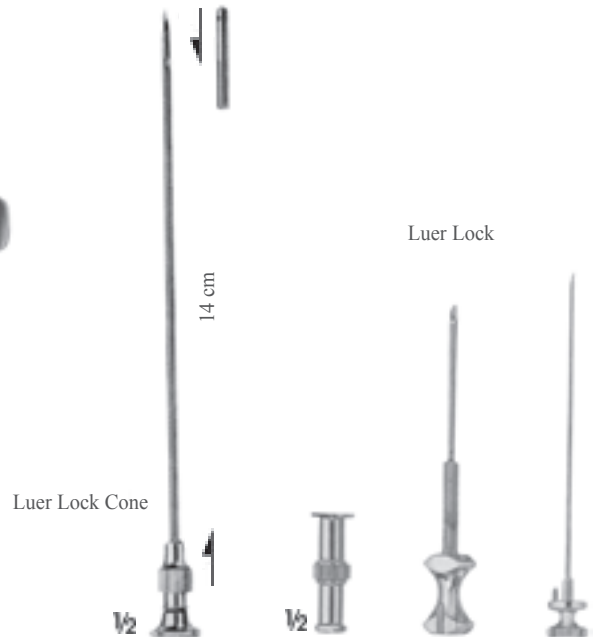

LANDAU
BJ-2004
Ø 2 mm
Pelvik apse trokar
Pelvic abscess trocar

KLIMA-ROSEGER
BJ-8913 35 x 1,8 mm
Göğüs kemiği delici iğne
Sternal puncture needle



Charr.
BF-7508 8
BF-7510 10
BF-7512 12
BF-7514 14
BF-7516 16
BF-7518 18
Arkası tırtıllı, bıçak tip, hafif eğri
With thread, knife tip, slightly curved
19 cm



Charr.
BF-7608 8
BF-7610 10
BF-7612 12
BF-7614 14
BF-7616 16
BF-7618 18
Arkası tırtıllı, bıçak tip, çok eğri
With thread knife tip, strongly curved
19 cm



Charr.
BF-7708 8
BF-7710 10
BF-7712 12
BF-7714 14
BF-7716 16
BF-7718 18
Arkası tırtıllı, bistüri tip, hafif eğri
With thread, lancet tip, slightly curved
19 cm



Charr.
BF-7808 8
BF-7810 10
BF-7812 12
BF-7814 14
BF-7816 16
BF-7818 18
Arkası tırtıllı, trokar tip, hafif eğri
With thread, trocar tip, slightly curved
19 cm



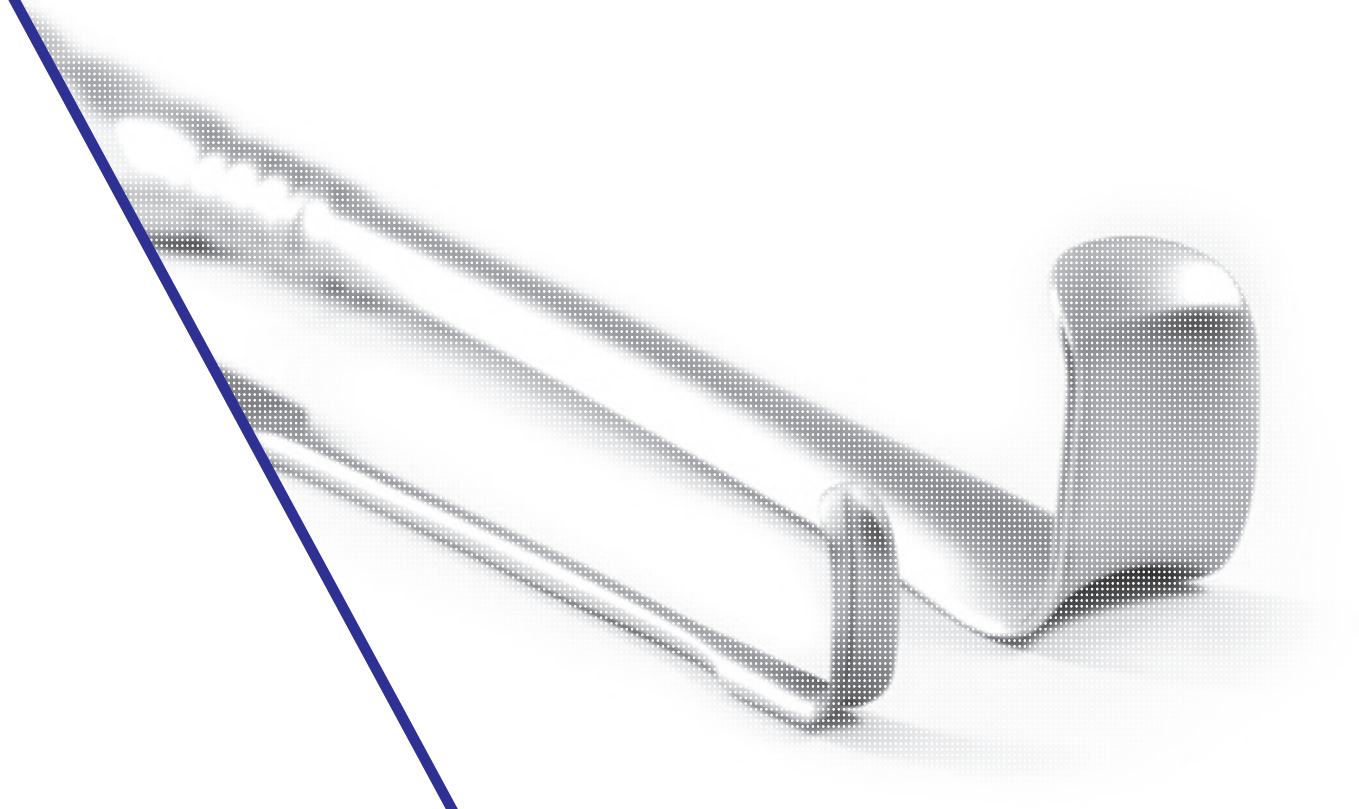

BK

El Ekartörleri, Huklar ve Spatulalar
Retractors, Hooks and Spatulas





BK-1310 BK-1311 BK-1312 BK-1313

KRAYENBÜLH
BK-1310 - BK-1313
18.5 cm



BK-1330 BK-1331 BK-1332 BK-1333

CASPAR
BK-1330 - BK-1333
Keşif prob uçlu, huklar
Exploration hooks, probe-ended
24.5 cm

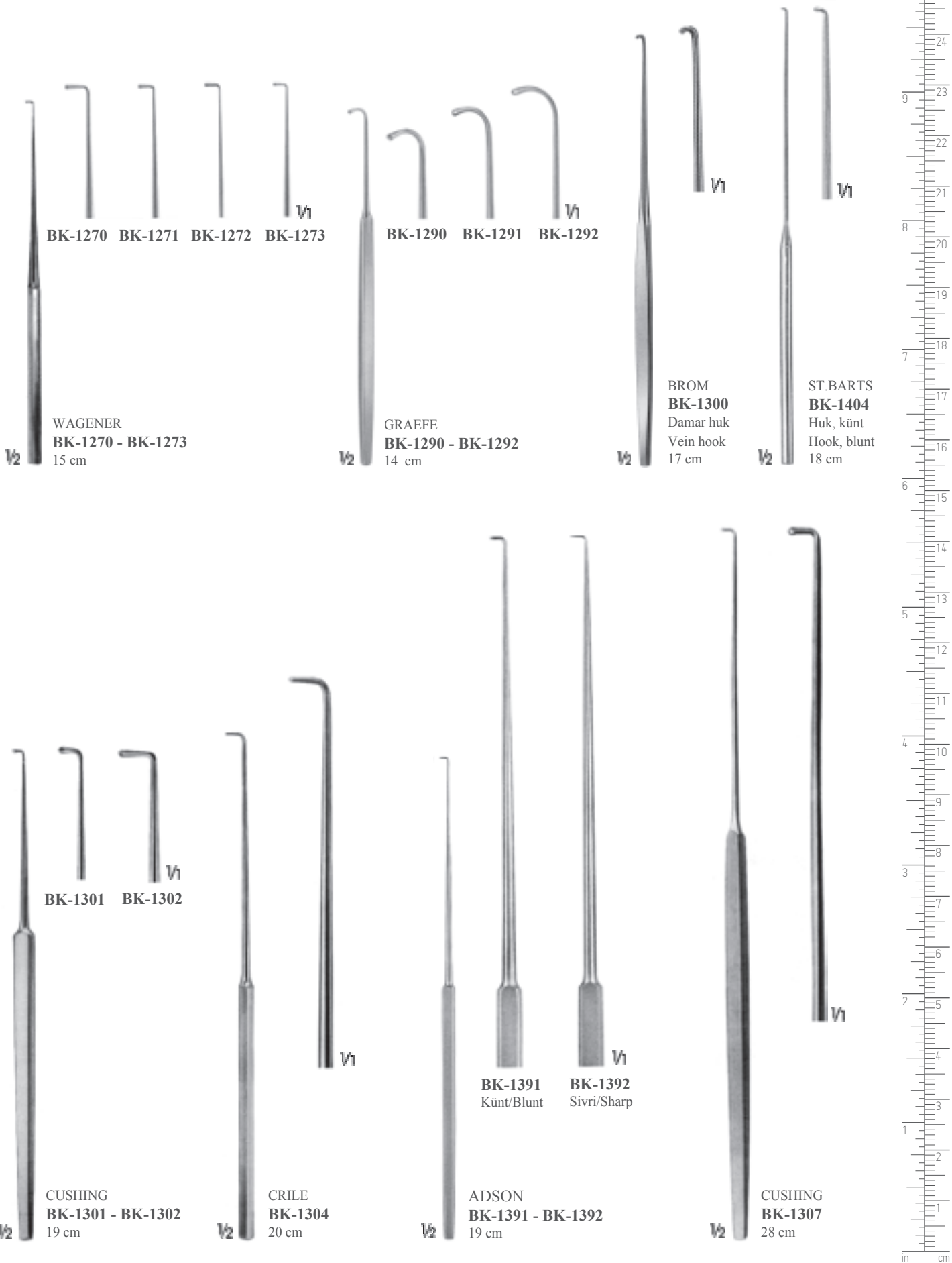

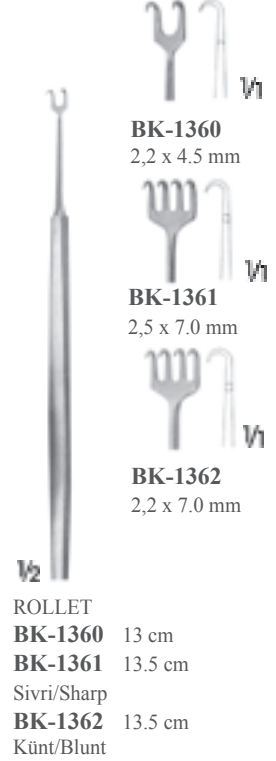
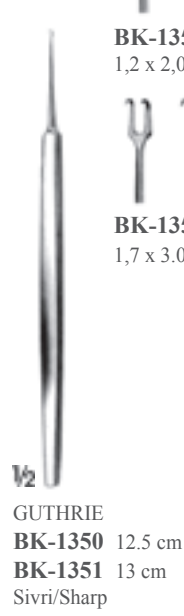



JAGER
BK-1370
13.5 cm



TÖNNIS
BK-1371
Dura ekartör
Dura retractor
15 cm



COTTLE
BK-1368
16 cm



BK-1375
Dura ekartör
Dura retractor
18.5 cm

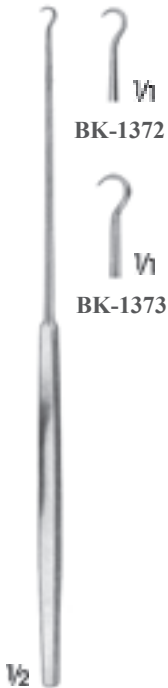

GILLIES
BK-1372 - BK-1373
18 cm

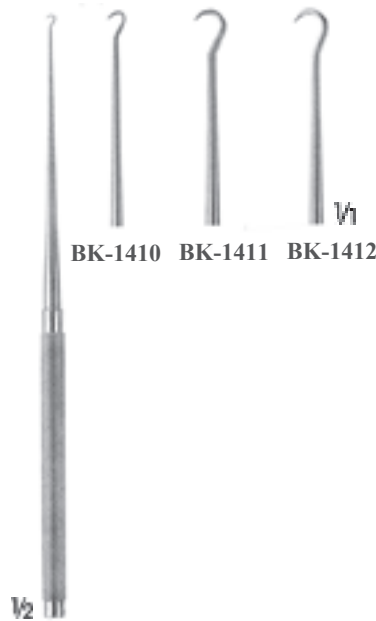

KLEINERT-KUTZ
BK-1410 - BK-1412
16 cm



JOSEPH
BK-1380 - BK-1390
16.5 cm





FISCH
BK-1377
Dura ekartör
Dura retractor
18.5 cm

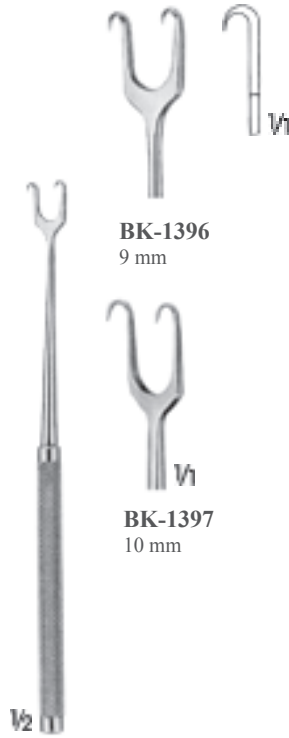

MC INDOE
BK-1396 - BK-1397
15 cm



BK-1393
Doku piki/Tissue pick
Doku ve deriyi yakalayıp
kaldırmak için çift uçlu
Double picks to grasp and
lift skin, tissue etc
18.5 cm

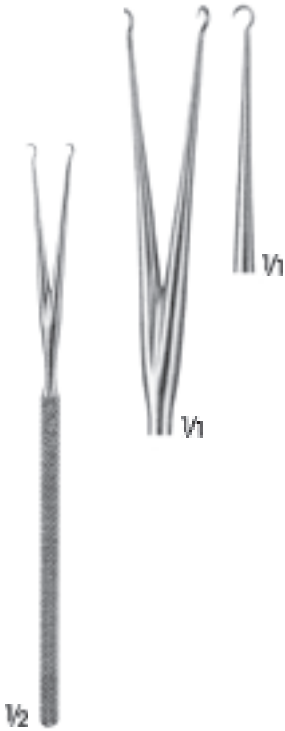

BARSKY
BK-1398
15.5 cm



KILNER
BK-1399
Sivri/Sharp
8 cm

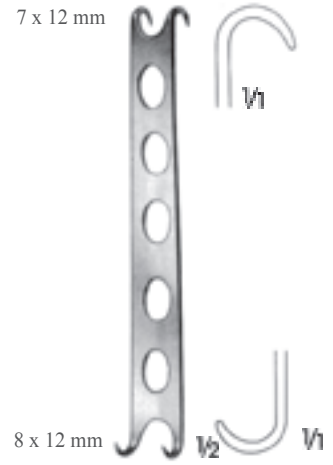

CONVERSE
BK-1400
Künt/Blunt
12 cm

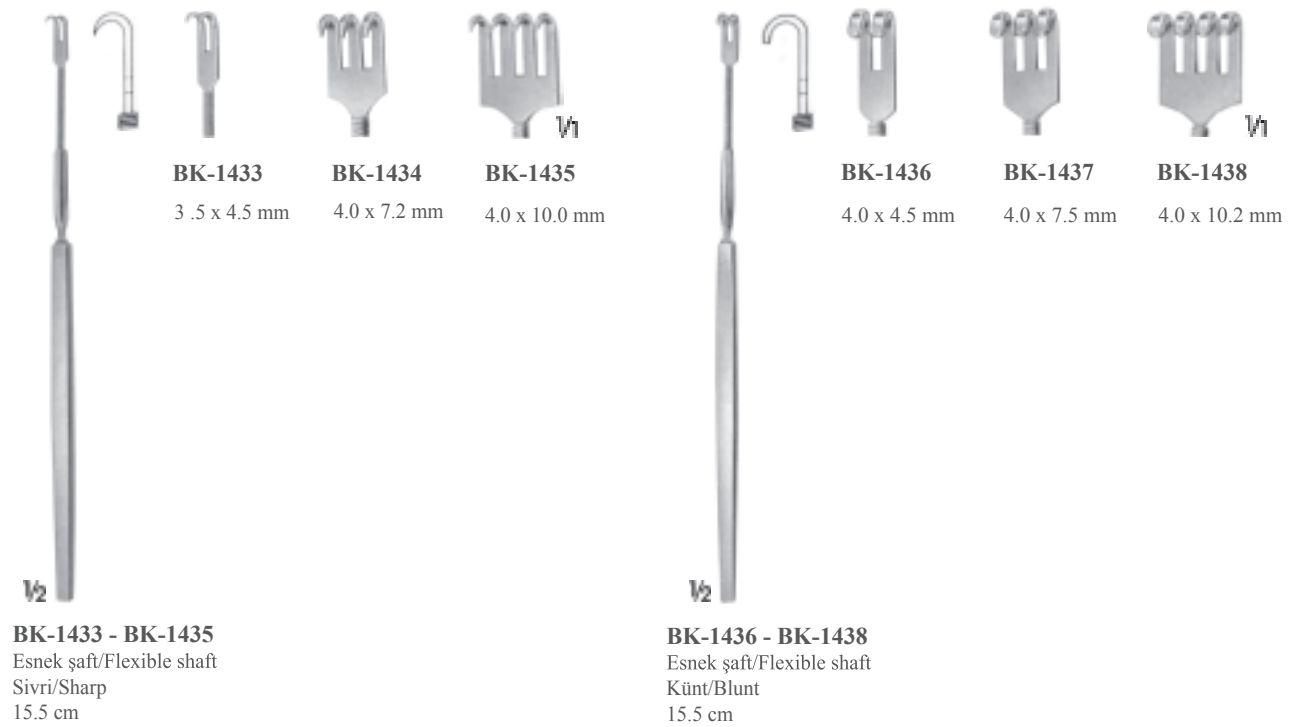
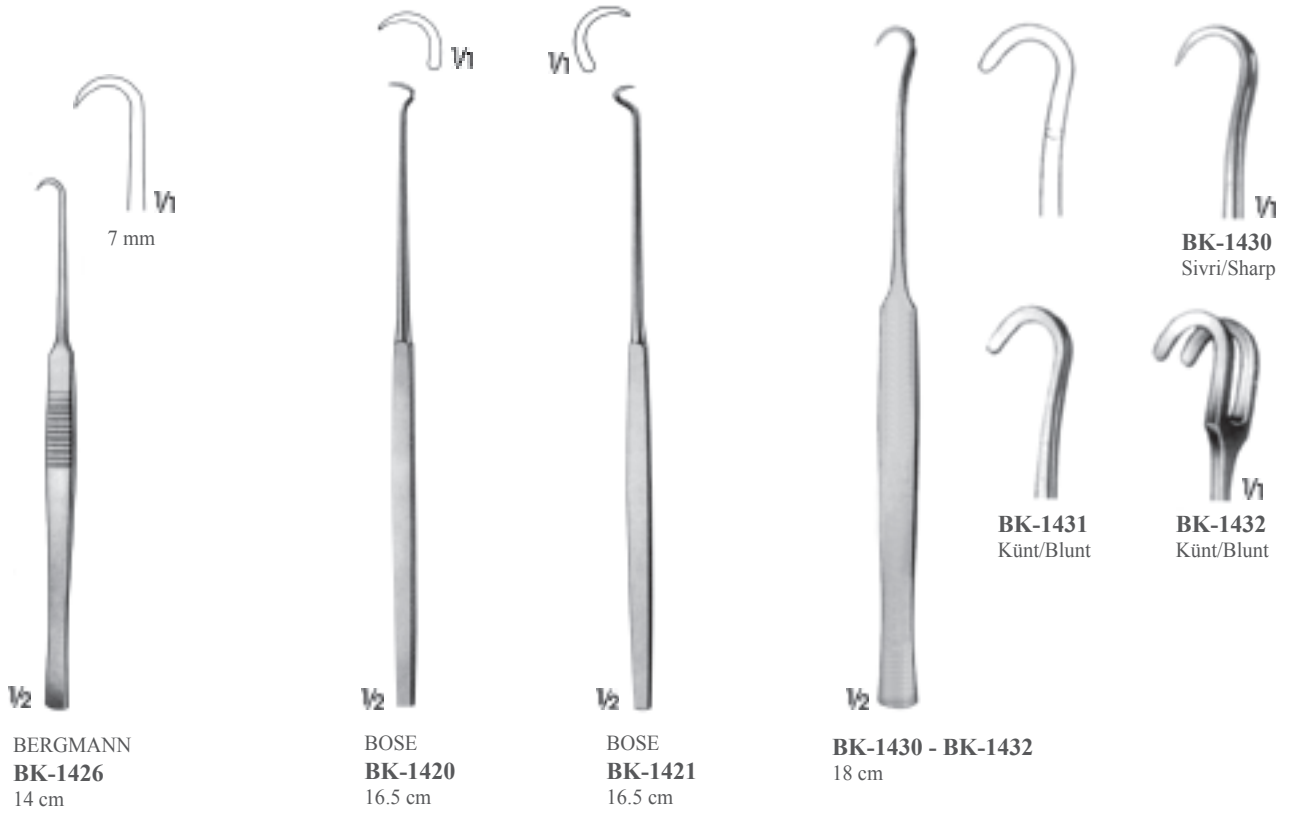



BK-1439

BK-1440

BK-1441

BK-1442

5.0 x 4.2 mm

5.0 x 7.0 mm

5.0 x 9.5 mm

V₂



BK-1443

BK-1444

BK-1445

BK-1446

4.5 x 4.2 mm

4.5 x 7.0 mm

4.5 x 9.5 mm

V₂

BK-1439 - BK-1442 Sivri/Sharp
Küçük eğri/Small curve
16.5 cm

BK-1443 - BK-1446 Kunt/Blunt
Küçük eğri/Small curve
16.5 cm



BK-1447

BK-1448

BK-1449

BK-1450

7.5 x 7.5 mm

7.5 x 10.0 mm

7.5 x 14 mm

V₂

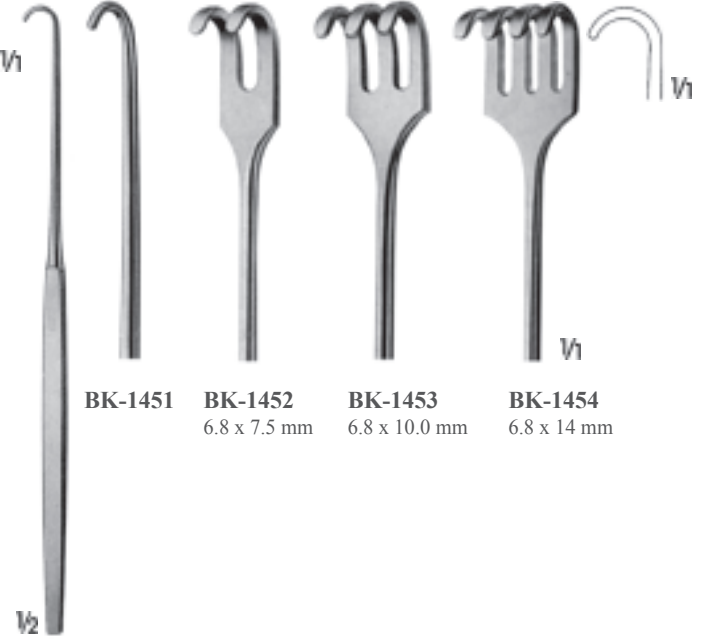

BK-1451

BK-1452

BK-1453

BK-1454

6.8 x 7.5 mm

6.8 x 10.0 mm

6.8 x 14 mm

V₂

BK-1447 - BK-1450 Sivri/Sharp
Büyük eğri/Large curve
16.5 cm

BK-1451 - BK-1454 Kunt/Blunt
Büyük eğri/Large curve
16.5 cm



MANNERFELT
BK-1460
Sivri/Sharp
13.5 cm



MANNERFELT
BK-1461
Sivri/Sharp
15.5 cm



MANNERFELT
BK-1462
Sivri/Sharp
15.5 cm



MANNERFELT
BK-1463
Esnek shaft küçük eğri, sivri
Flexible shaft, small curve,
sharp
15.5 cm

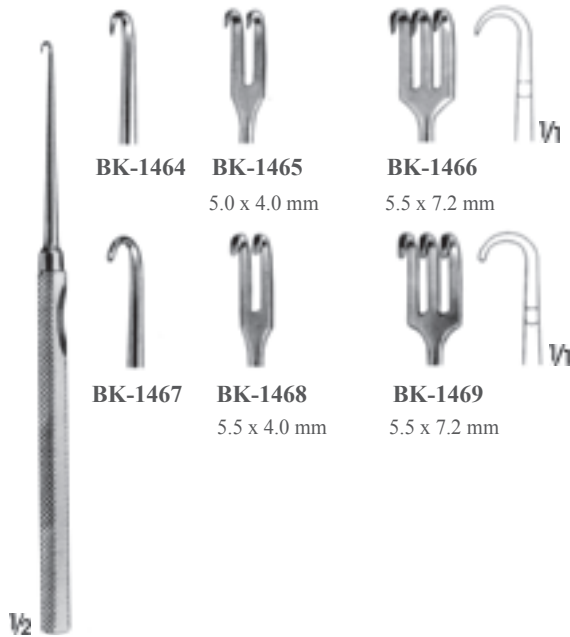

MANNERFELT
BK-1464 - BK-1466 Sivri/Sharp
BK-1467 - BK-1469 Künt/Blunt
Küçük eğri/Small curve
15.5 cm

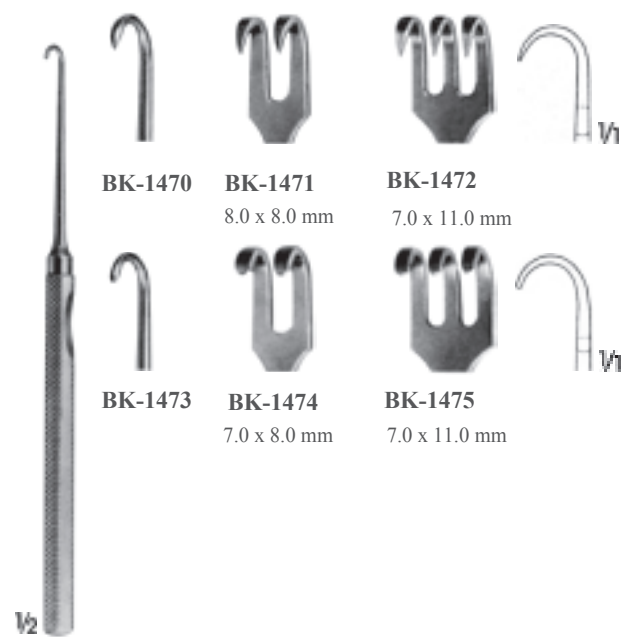

MANNERFELT
BK-1470 - BK-1472 Sivri/Sharp
BK-1473 - BK-1475 Künt/Blunt
Büyük eğri/Large curve
15.5 cm





V₂

MANNERFELT
BK-1476
Oluklu/Hollow grooved
15.5 cm



V₂

LANGENBECK-MANNERFELT
BK-1480 - BK-1483
15.5 cm

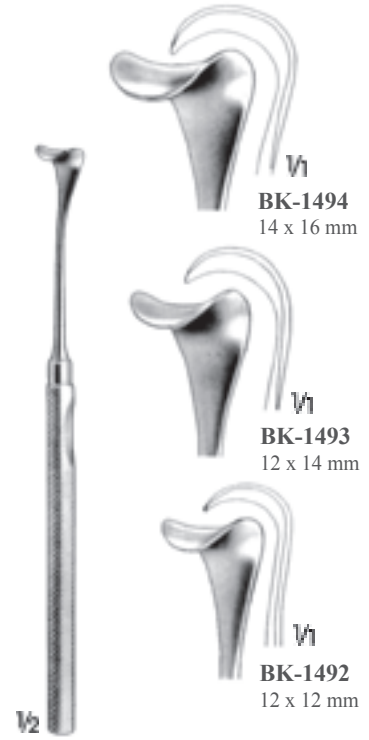

V₂

MANNERFELT
BK-1492 - BK-1494
Eyer huklar/Saddle hooks
15.5 cm



V₂

MANNERFELT
BK-1490 - BK-1491
Geri eğimli çatallı huk
Forked hooks, retrograded
curved
15.5 cm



BK-1491
10,2 x 21.5 mm



V₂

MANNERFELT
BK-1495
Eyer huk, çerçevesi
Saddle hook, fenestrated
15.5 cm



V₂

MANNERFELT
BK-1496
Tendon çift uçlu huk
Tendon double hook
16 cm





EMMET
BK-1512
Fistül huk/Fistula hook
22 cm



SIMON
BK-1513
Fistül huk/Fistula hook
22 cm



SIMON
BK-1514
Fistül huk/Fistula hook
22 cm



LANGE
BK-1515
Fistül huk/Fistula hook
23.5 cm



MASING
BK-1564
Yara ekartör /Wound retractor
14 cm



COTTLE
BK-1565
Yara ekartör /Wound retractor
14 cm



DESMARRES
BK-1570 - BK-1574
Yara ekartörleri /Wound retractors
14 cm



BK-1570
9 x 9 mm



BK-1571
9 x 12 mm



BK-1572
11 x 14 mm



BK-1573
12 x 16 mm



BK-1574
13 x 18 mm



10 x 10 mm

1/2

CUSHING-KOCHER
BK-1582
17.5 cm



BK-1590
12 x 16 mm

1/2

KÖNIG
BK-1585 - BK-1590
18 cm



BK-1585
13 x 13 mm



BK-1581
14 x 18 mm

1/2

CUSHING
BK-1580 - BK-1581
20.5 cm



BK-1580
10 x 13 mm



Damar boyunca diseksiyon
Für longitudinal dissection of
vessels

1/2

BK-1563
Küçük diseksiyon huk
Small dissecting hook
23.5 cm



20 x 15 mm

1/2

BK-1630
20.5 cm

20 x 19 mm



13 x 6 mm

1/2

SCHOENBORN
BK-1620
20 cm



BK-1925
15 x 22 mm

1/2

CUSHING
BK-1725 - BK-1925
25 cm



BK-1825
13 x 18 mm



BK-1725
11 x 14 mm



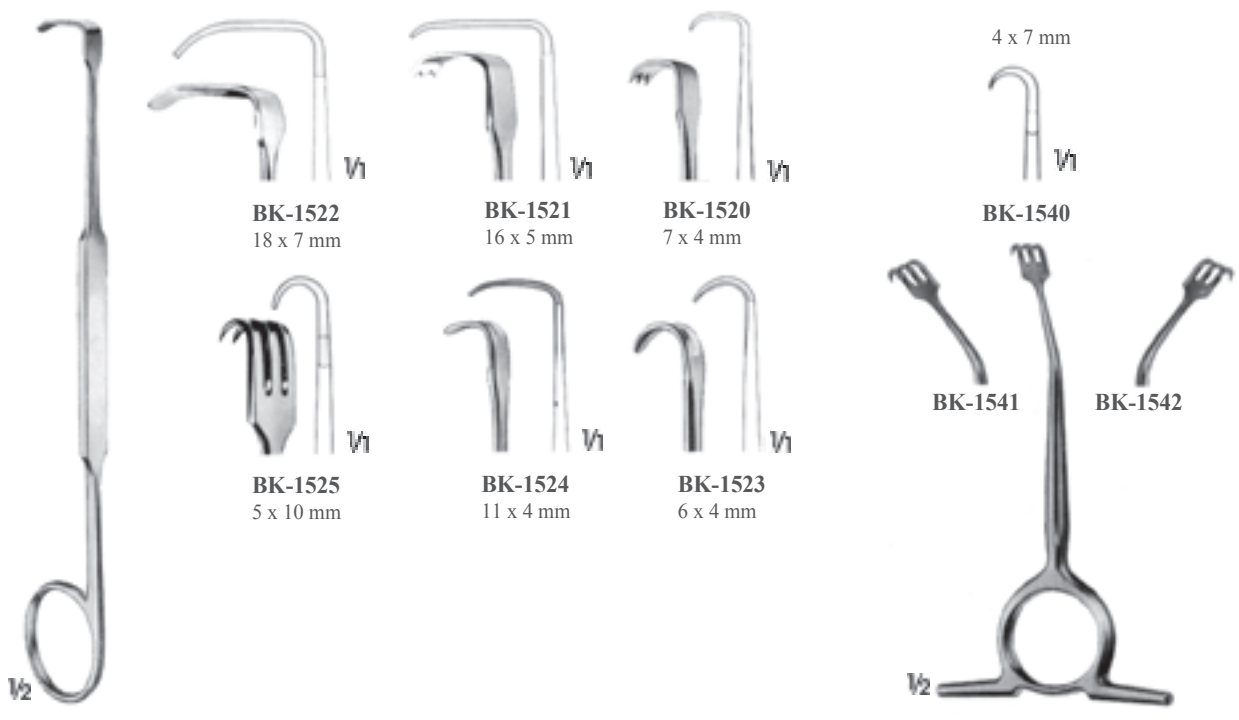

MEYERDING
BK-1520 - BK-1525
18 cm

WILLIGER
BK-1540 - BK-1542
Sivri/Sharp
12 cm

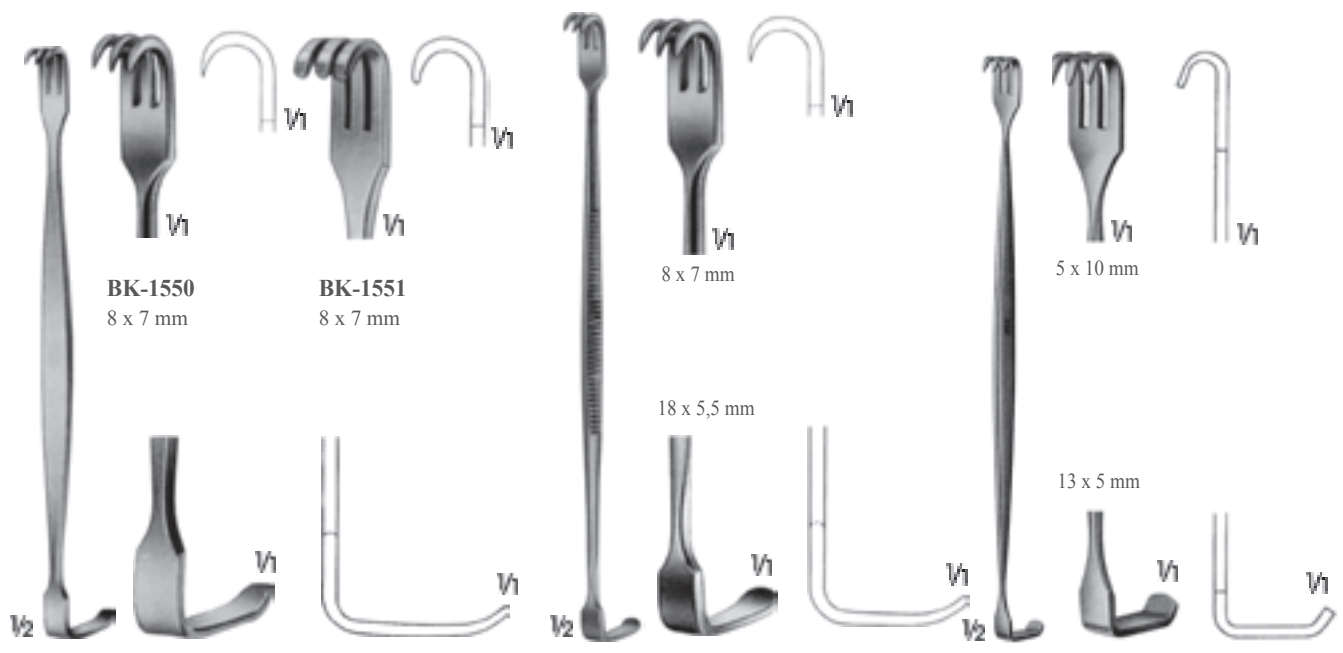

BABY-SENN-MILLER
BK-1550 - BK-1551
15.5 cm

SENN-MILLER
BK-1552
16.5 cm

KILNER
BK-1535
15.5 cm

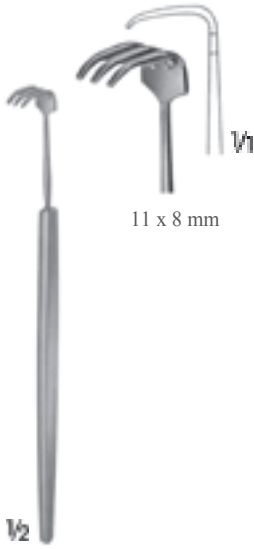

PAUL
BK-1556
Tendon huk/Tendon hook
12 cm



BK-1557
12 x 6 mm

BK-1557 - BK-1558
Tendon hukları/Tendon hooks
17.5 cm

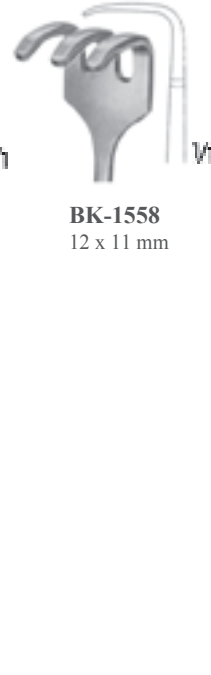

BK-1558
12 x 11 mm



15 x 11 mm

KLAPP
BK-1559
Tendon huk/Tendon hook
17.5 cm

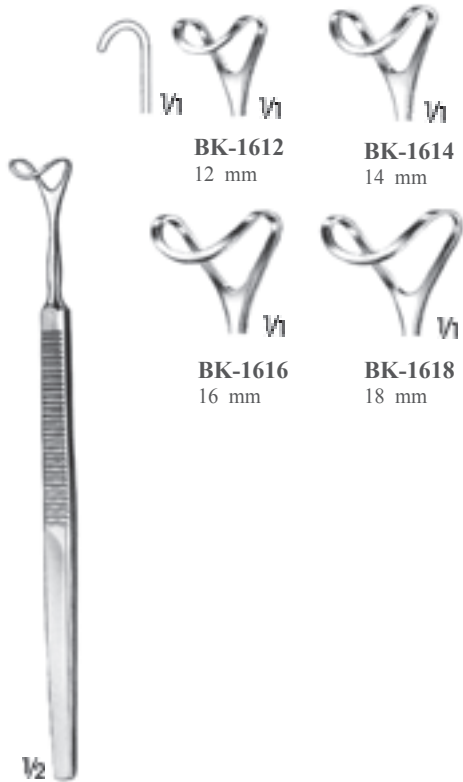

BK-1612 - BK-1618
16 cm



KOCHER
BK-2002 - BK-2003
20.5 cm

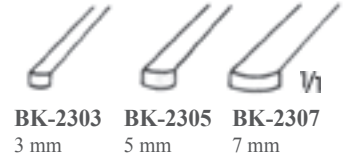

LOVE
BK-2010 - BK-2030
22 cm

HESS
BK-2303 - BK-2307
Sinir kökü ekartörü
Nerve root retractors
17.5 cm



CASPAR
BK-2104 4 mm
BK-2106 6 mm
BK-2108 8 mm
BK-2110 10 mm
24 cm



LOVE
BK-2040
21 cm



Esnek/Flexible
21 cm



CAMPBELL
BK-2330 10 mm
Bükülebilir/Malleable
21.5 cm

11 x 4 mm



$\frac{1}{2}$
19 x 6 mm
CRILE
BK-2350
11 cm

10 x 8 mm



$\frac{1}{2}$
12 x 11 mm
LUER
BK-2355
11 cm

10 x 12 mm



$\frac{1}{2}$
11 x 15 mm
ROSE
BK-2360
13 cm

5 x 3 mm



$\frac{1}{2}$
14 x 6.3 mm
RAGNELL
BK-2365
15 cm

25 x 10 mm
22 x 10 mm



$\frac{1}{2}$
28 x 12 mm
32 x 12 mm
FARABEUF
BK -2412
12.5 cm

23 x 16 mm
20 x 16 mm



$\frac{1}{2}$
24 x 16 mm
28 x 16 mm
FARABEUF
BK -2415
15 cm

21 x 14 mm
17 x 14 mm



$\frac{1}{2}$
28 x 16 mm
32 x 16 mm
COLLIN
BK -2515
15 cm





22 x 15 mm
18 x 15 mm



18 x 15 mm
22 x 15 mm
PARKER
BK-2613
13.5 cm

17 x 16 mm



18 x 22 mm
BABY-ROUX
BK-2713
13.5 cm

36 x 44 mm
30 x 24 mm



36 x 44 mm
30 x 24 mm
PARKER
BK-2818
18 cm

20 x 22 mm



25 x 29 mm
ROUX
BK-2915
15 cm

25 x 26 mm



30 x 38 mm
ROUX
BK-2916
16 cm

28 x 29 mm



33 x 44 mm
ROUX
BK-2917
17 cm

30 x 19 mm



33 x 25 mm
KILNER
BK-2920
15 cm

35 x 29 mm



40 x 35 mm
KILNER
BK-2975
15 cm



GOELET
BK-2970
19 cm



ROUX
BK-2950
Komple/Complete
(BK-2951 - BK-2952 - BK-2953)
16.5 cm

19 x 22 mm



23 x 30 mm
BK-2951

25 x 26 mm



28 x 38 mm
BK-2952

28 x 29 mm



33 x 45 mm
BK-2953





**ROUX
BK-2954**
17 cm



**ROUX
BK-2955**
19 cm



CANNY-RYALL
BK-2995 16 mm 19 cm
BK-2996 20 mm 19 cm
BK-2997 25 mm 20 cm



**LANE
BK-2960**
23 cm



**LANE
BK-2965**
23 cm



**HAJEK
BK-2990**
16.5 cm



STERNBERG
BK-3020 12 cm
BK-3021 13 cm
BK-3022 13.5 cm

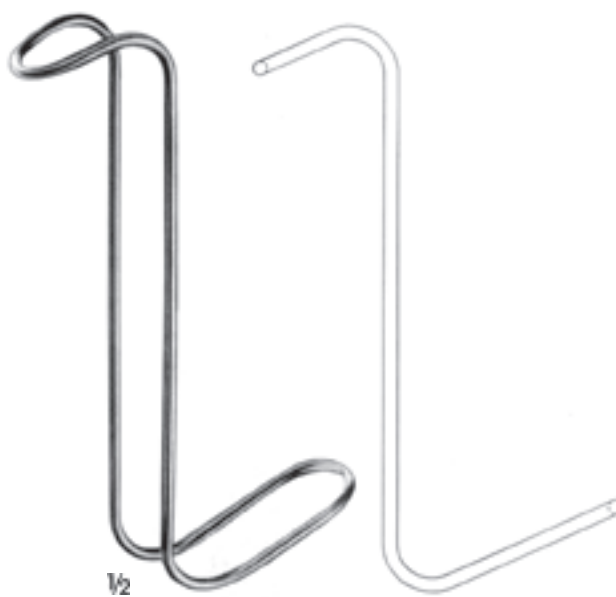

COLLIN-HARTMANN
BK-3035
15 cm



CZERNY
BK-3001
17.5 cm



MATHIEU
BK-3005
20 cm



US-ARMY
BK-3010
22 cm

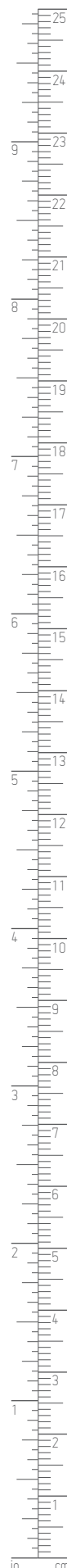





VOLKMANN
BK-4300 - BK-4303
BK-4400 - BK-4403
22.5 cm



VOLKMANN
BK-4500 - BK-4504
BK-4600 - BK-4604
BK-4700 - BK-4704
22 cm

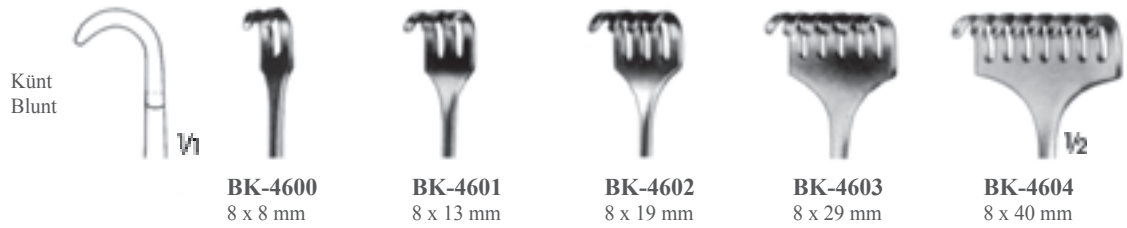
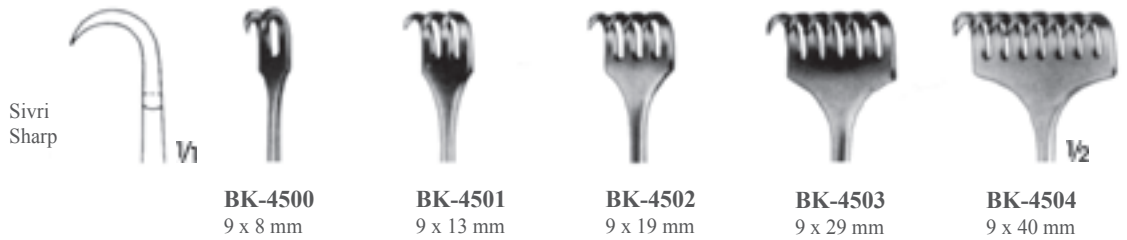



Yarı sivri
Semi-sharp

Künt
Blunt

KOCHER

BK-4800 - BK-4803

BK-4900 - BK-4903

22 cm

1/2

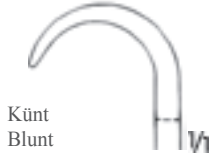

BK-4800
16 x 9 mm

BK-4801
16 x 14 mm

BK-4802
16 x 20 mm

BK-4803
16 x 30 mm



BK-4900
15.5 x 9 mm

BK-4901
15.5 x 14 mm

BK-4902
15.5 x 20 mm

BK-4903
15.5 x 30 mm

26 x 40 mm

26 x 40 mm

28 x 40 mm

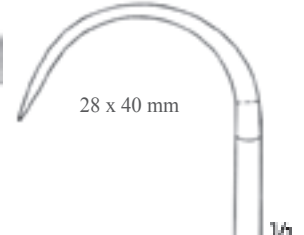

BK-5000
8 dişli, yarı sivri
8 prongs, semi-sharp

BK-5001
8 dişli, künt
8 prongs, blunt

KÖRTE

BK-5000 - BK-5001

Dikey saplı bleyd

Handle vertical to the blade

24 cm

1/2

KÖRTE- WAGNER

BK-5002

8 dişli, yarı sivri

8 prongs, semi sharp

28 cm

1/2

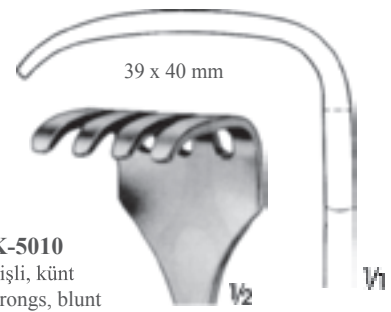
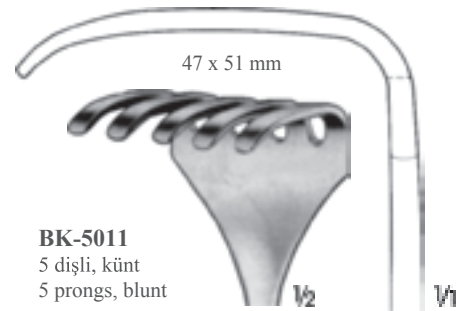
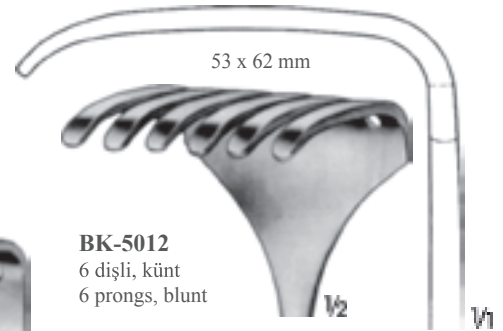
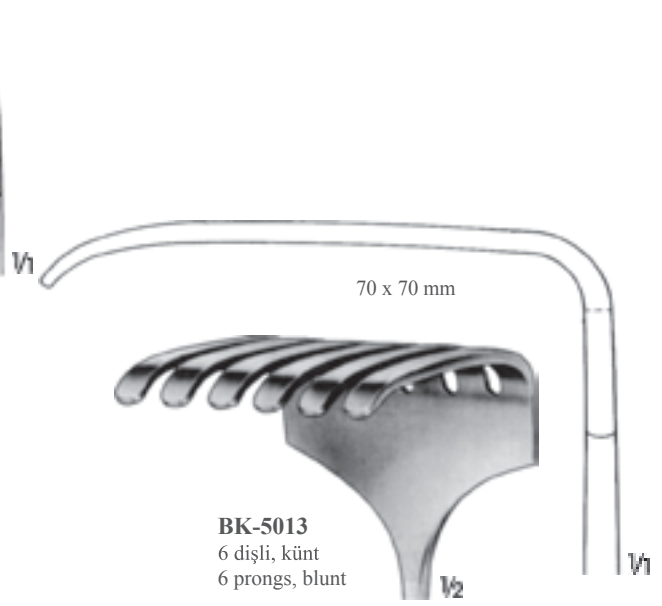



BK-5020
Sivri/Sharp

BK-5021
Sivri/Sharp

BK-5022
Künt/Blunt

BK-5023
Künt/Blunt

MURPHY
BK-5020 - BK-5023
19.5 cm



LANGENBECK
BK-5040 - BK-5042
23 cm

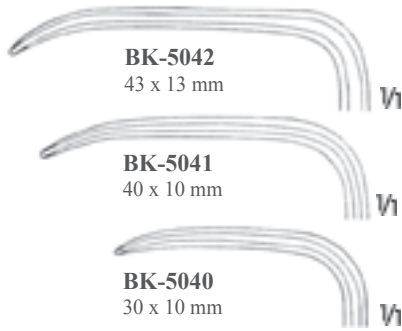

BK-5042
43 x 13 mm

BK-5041
40 x 10 mm

BK-5040
30 x 10 mm



LANGENBECK
BK-5043 - BK-5048
21 cm

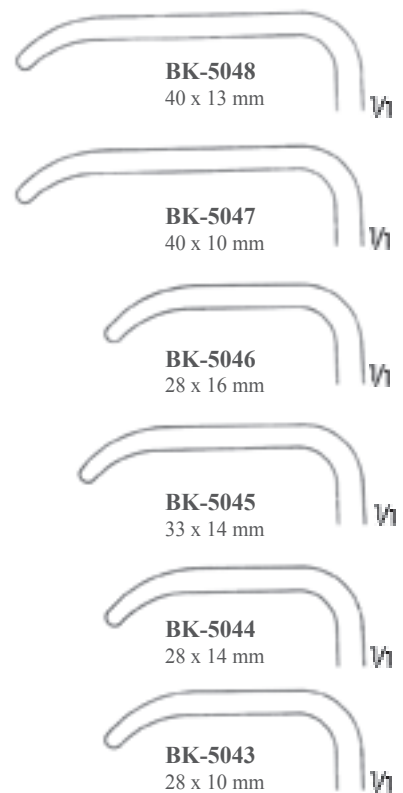

BK-5048
40 x 13 mm

BK-5047
40 x 10 mm

BK-5046
28 x 16 mm

BK-5045
33 x 14 mm

BK-5044
28 x 14 mm

BK-5043
28 x 10 mm



KOCHER-LANGENBECK
BK-5050 - BK-5059
21.5 cm



BK-5050
25 x 6 mm



BK-5052
35 x 8 mm

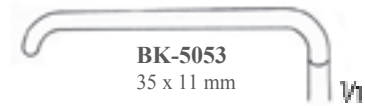

BK-5053
35 x 11 mm

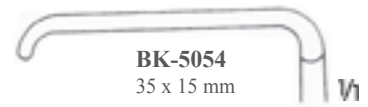

BK-5054
35 x 15 mm

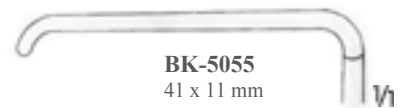

BK-5055
41 x 11 mm



BK-5056
55 x 11 mm



BK-5057
70 x 14 mm



BK-5058
80 x 12 mm



BK-5059
80 x 16 mm



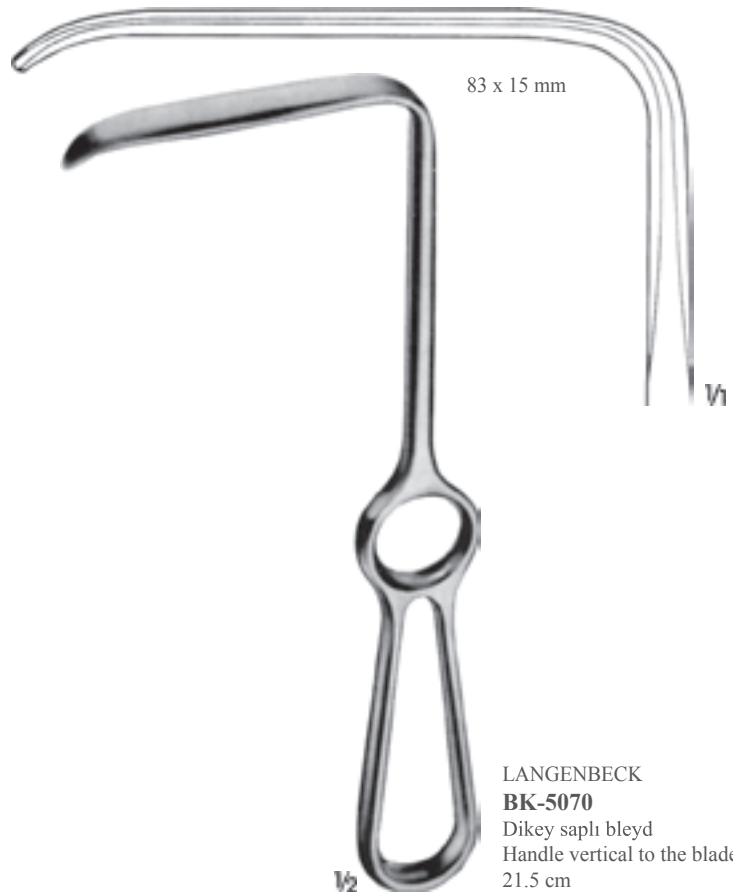
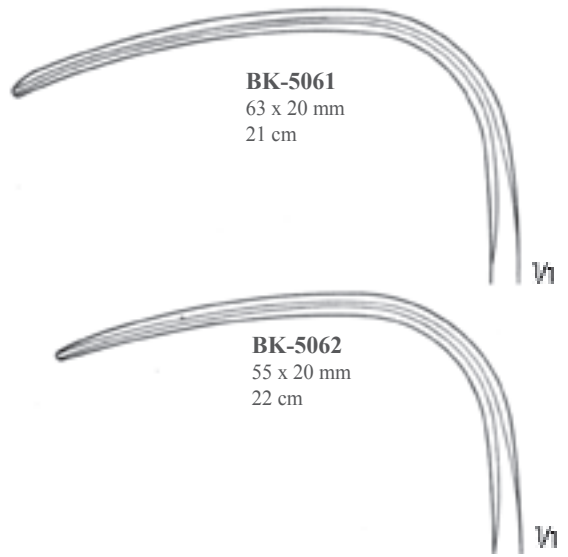



V₂

OBWEGESER
BK-5080 - BK-5085
21.5 cm

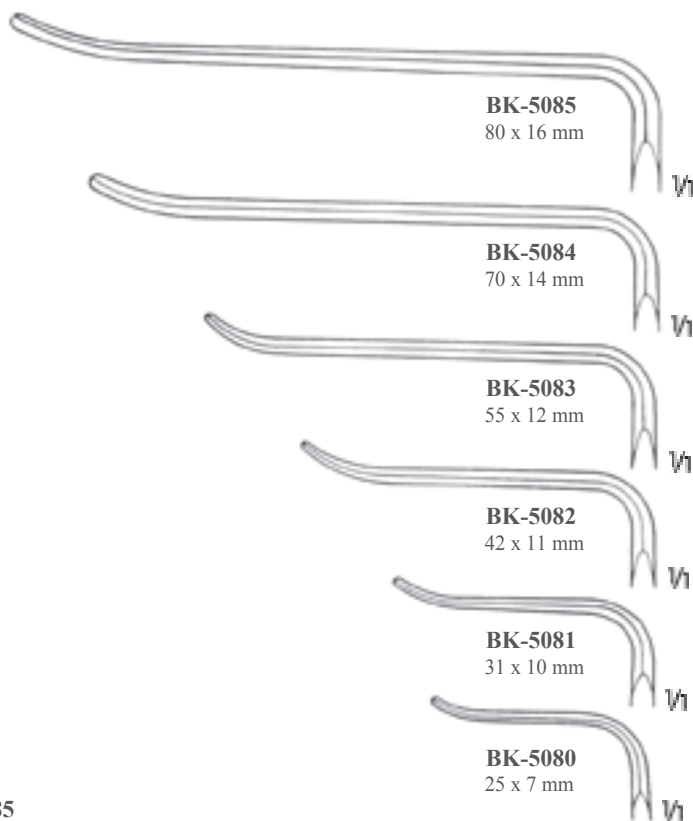

BK-5085
80 x 16 mm

BK-5084
70 x 14 mm

BK-5083
55 x 12 mm

BK-5082
42 x 11 mm

BK-5081
31 x 10 mm

BK-5080
25 x 7 mm



V₂

OBWEGESER
BK-5086 - BK-5091
21.5 cm

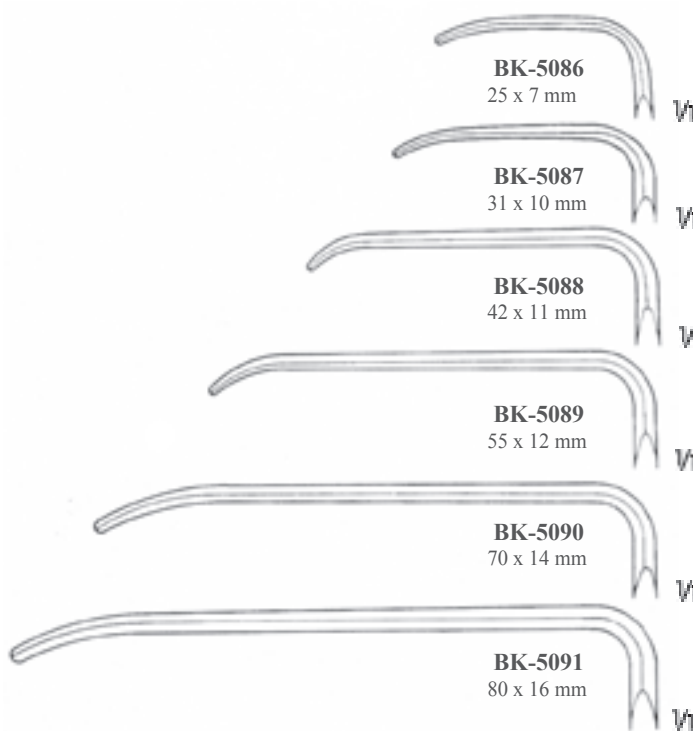

BK-5086
25 x 7 mm

BK-5087
31 x 10 mm

BK-5088
42 x 11 mm

BK-5089
55 x 12 mm

BK-5090
70 x 14 mm

BK-5091
80 x 16 mm





KOCHER
BK-5100 - BK-5104
23 cm

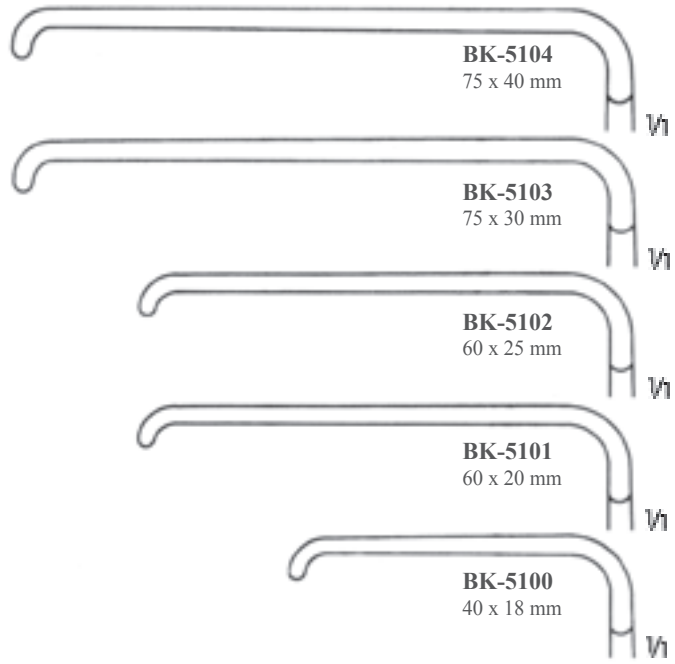

BK-5104
75 x 40 mm

BK-5103
75 x 30 mm

BK-5102
60 x 25 mm

BK-5101
60 x 20 mm

BK-5100
40 x 18 mm



SAUERBRUCH
BK-5200 - BK-5202
22.5 cm

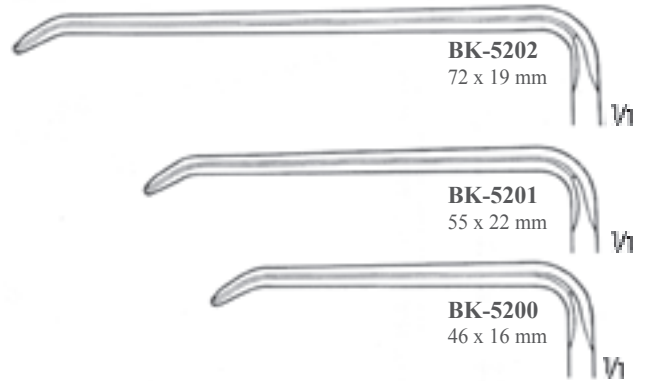

BK-5202
72 x 19 mm

BK-5201
55 x 22 mm

BK-5200
46 x 16 mm



3/4

KIRSCH
BK-5400 - BK-5401
21 cm

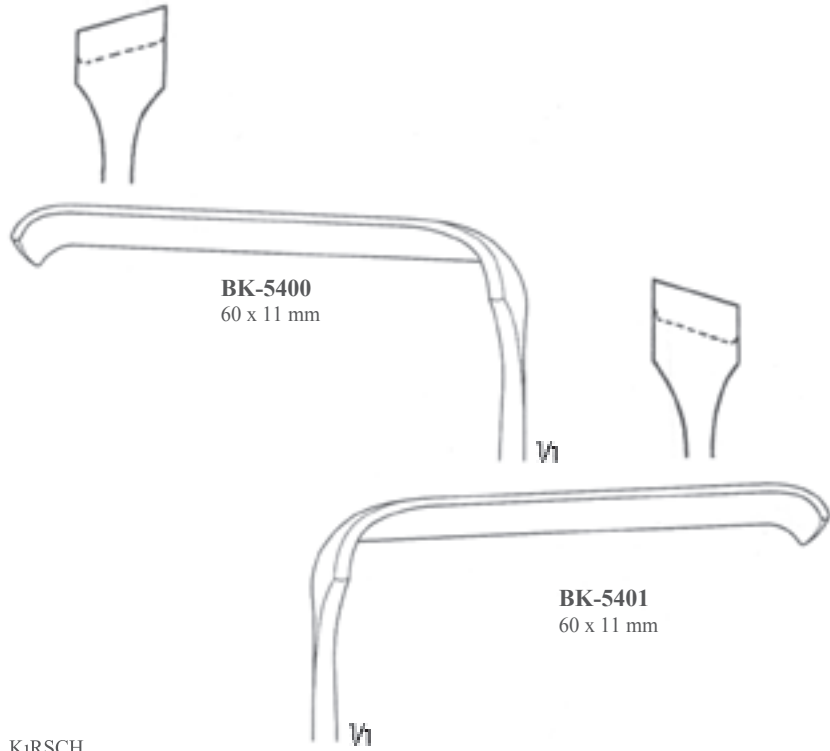

BK-5400
60 x 11 mm

BK-5401
60 x 11 mm



BK-5601
53 x 15 mm
22.5 cm

BK-5600
59 x 20 mm
21.5 cm

SCHULZ
BK-5600 - BK-5601

Emiş tertibatlı ekartör, ufak ameliyatlarda ve tek elle kullanılır.
Retractor with suction device, for one-handed operation in minor surgery.





SMILLE
BK-5610 - BK-5614
14 cm



BK-5610
12 x 13 mm

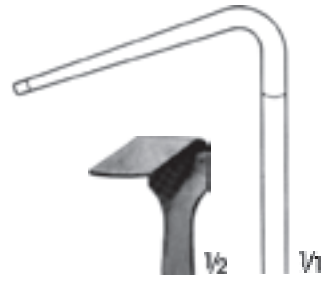

BK-5611
32 x 19 mm



BK-5612
48 x 19 mm

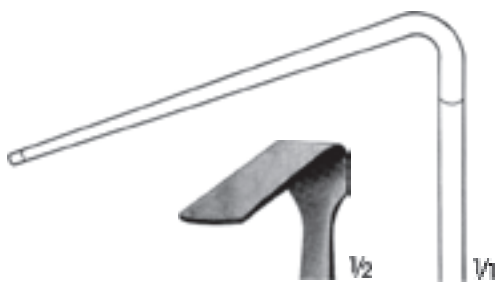

BK-5613
57 x 19 mm



BK-5614
52 x 13 mm

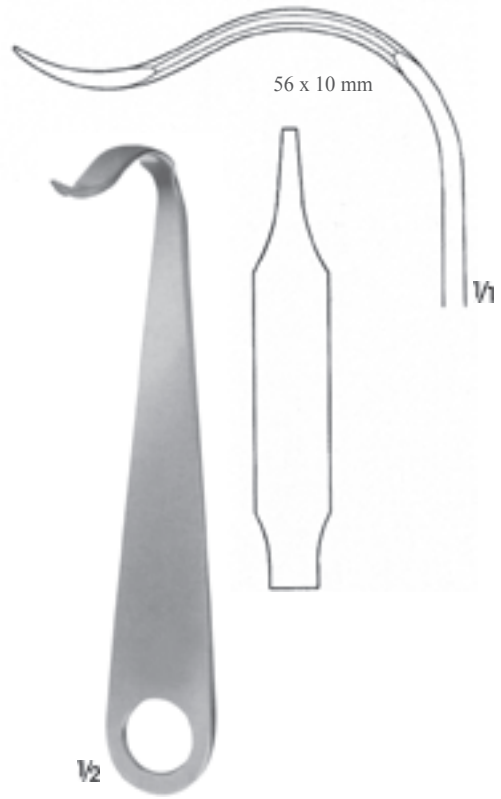

BK-5620
17 cm

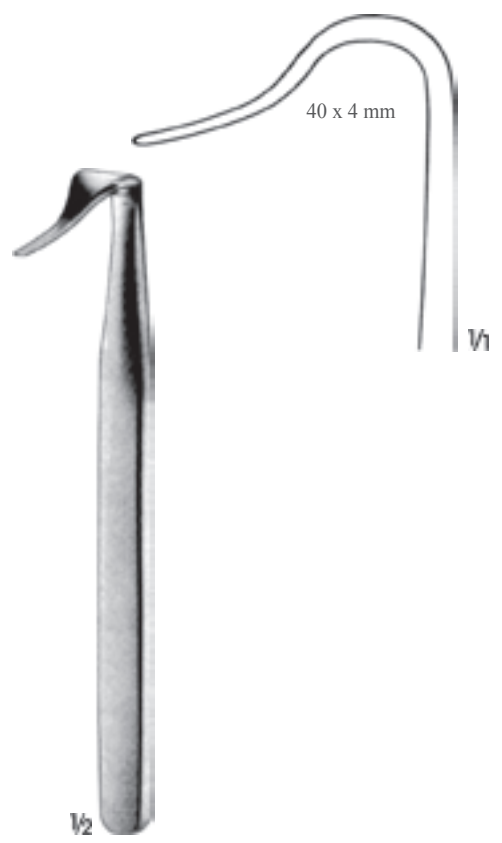

BLOUNT
BK-5625
17.5 cm

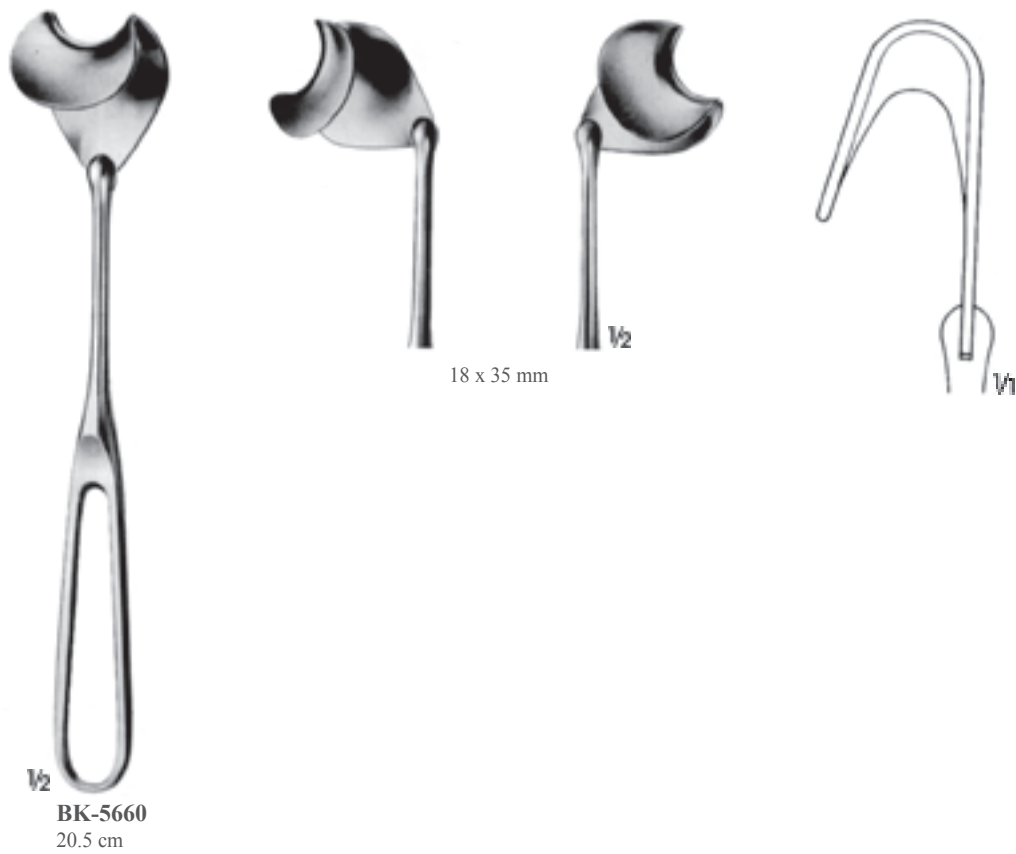



MIDDELDORPF
BK-5640 - BK-5642



BK-5640
15 x 15 mm
22 cm



BK-5641
20 x 22 mm
21.5 cm



BK-5642
28 x 28 mm
23.5 cm



V₂

GREENE
BK-5650
22.5 cm



22 x 22 mm



16 x 25 mm

V₂

DURHAM
BK-5655
21.5 cm





V₂

RICHARDSON
BK-5680 - BK-5682
24 cm



BK-5682
37 x 37 mm

V₁



BK-5681
30 x 29 mm

V₁



BK-5680
23 x 20 mm

V₁



V₂

RICHARDSON
BK-5683
24 cm

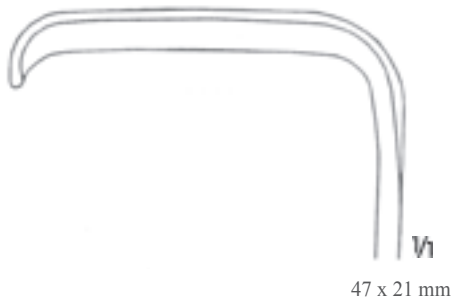

47 x 21 mm

V₁



V₂

KELLY
BK-5690 - BK-5693
26 cm

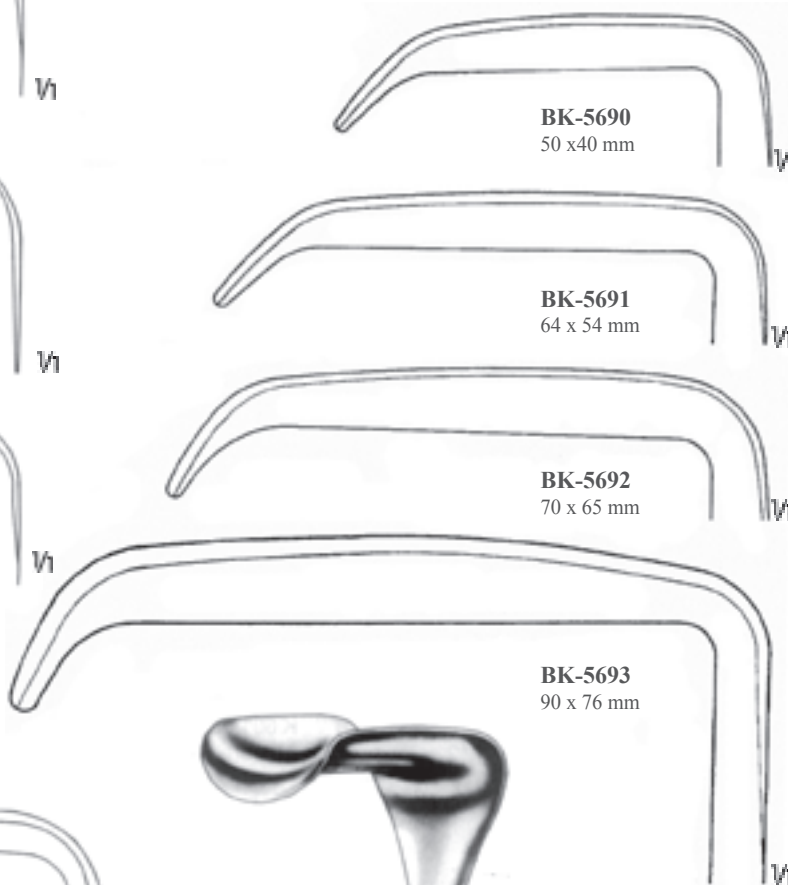

BK-5690
50 x 40 mm

V₁

BK-5691
64 x 54 mm

V₁

BK-5692
70 x 65 mm

V₁

BK-5693
90 x 76 mm

V₁





V1

65 x 41 mm

V2

RICHARDSON
BK-5700
25 cm

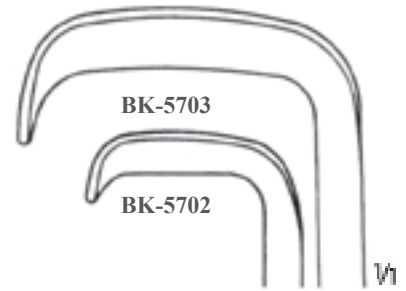

BK-5703

BK-5702

38 x 37 mm
22 x 21 mm

V1

29 x 30 mm
64 x 43 mm

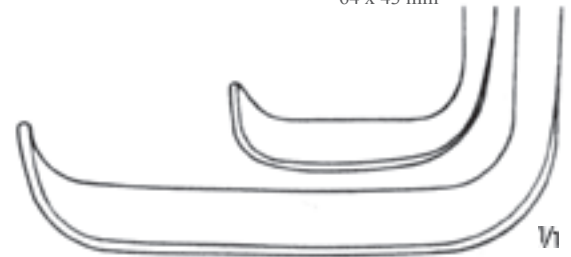

V1



RICHARDSON-EASTMAN
BK-5701
Komple/Complete
BK-5702 25 cm
BK-5703 27 cm

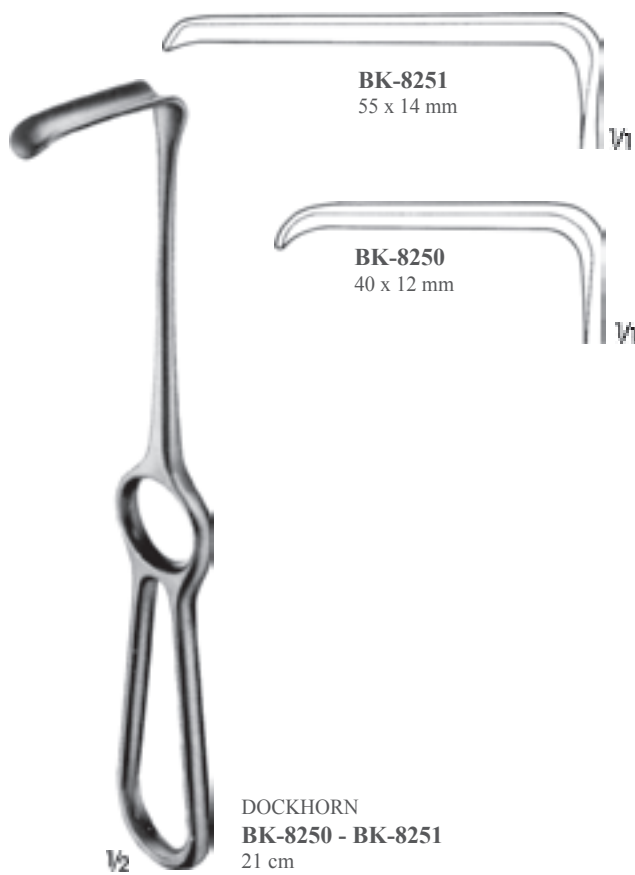

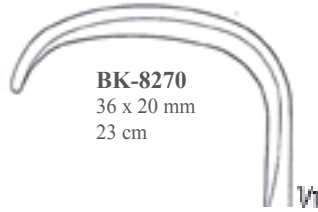

BK-8270
36 x 20 mm
23 cm

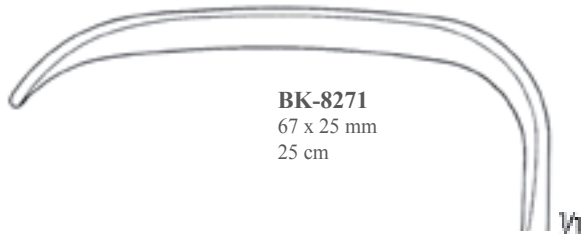

BK-8271
67 x 25 mm
25 cm

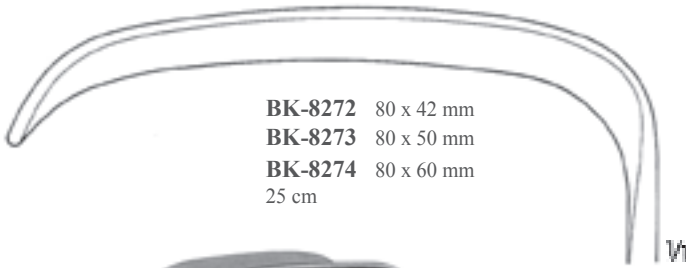

BK-8272 80 x 42 mm
BK-8273 80 x 50 mm
BK-8274 80 x 60 mm
25 cm



BK-8280 70 x 40 mm
BK-8281 70 x 50 mm
BK-8282 70 x 65 mm



KOCHER
BK-8270 - BK-8274



MORRIS
BK-8280 - BK-8282
24.5 cm





BK-8303
94 x 36 mm

BK-8302
64 x 25 mm

BK-8301
36 x 20 mm

BK-8300
20 x 15 mm

KOCHER-WAGNER
BK-8300 - BK-8303
28 cm

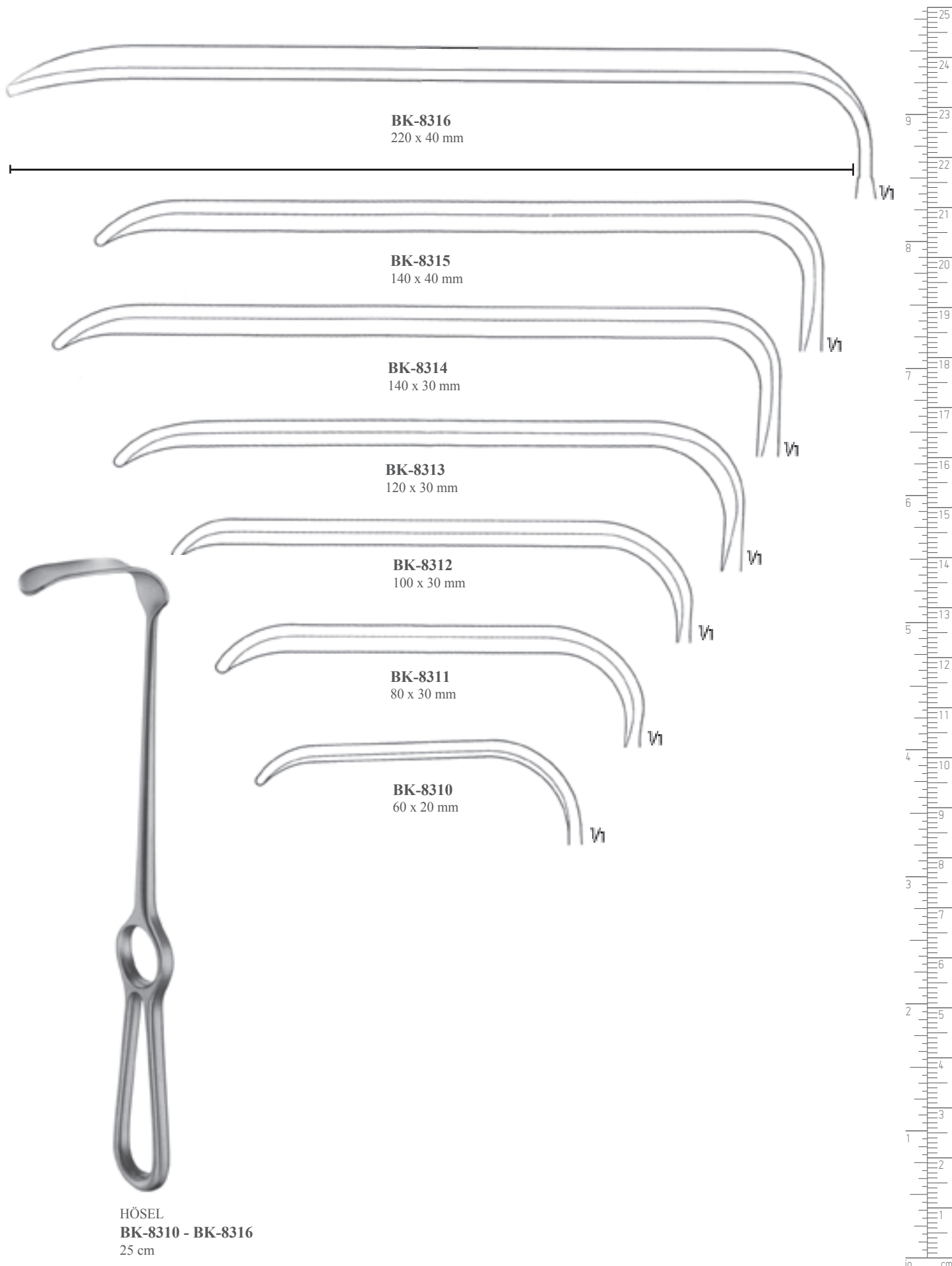

HÖSEL
BK-8310 - BK-8316
25 cm



115 x 26 mm

115 x 22 mm

105 x 27 mm

95 x 20 mm

TÜBINGER
BK-8320
26.5 cm

BK-8325
25 cm

SIMON
BK-8330
27.5 cm

SIMON
BK-8335
27.5 cm



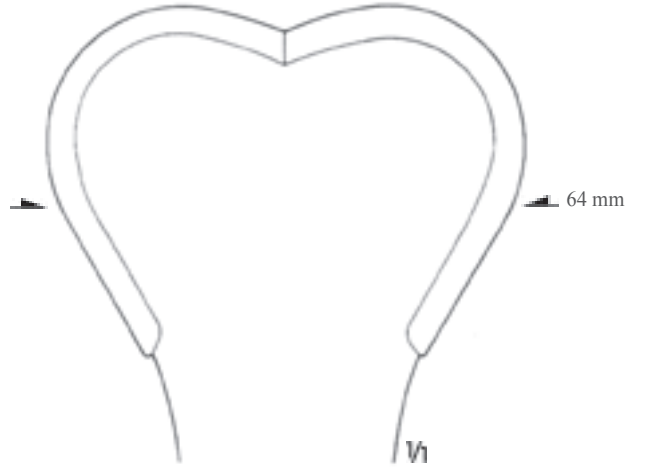
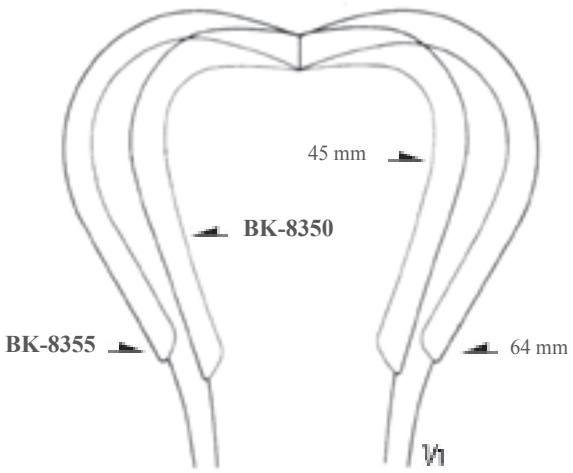

HARRINGTON
BK-8350 123 x 45 mm
BK-8355 123 x 64 mm
Esnek/Flexible
29.5 cm

HARRINGTON-PEMBERTON
BK-8360 175 x 64 mm
Esnek/Flexible
29.5 cm



ALLISON
BK-8370
25.5 cm



ALLISON
BK-8371
32 cm

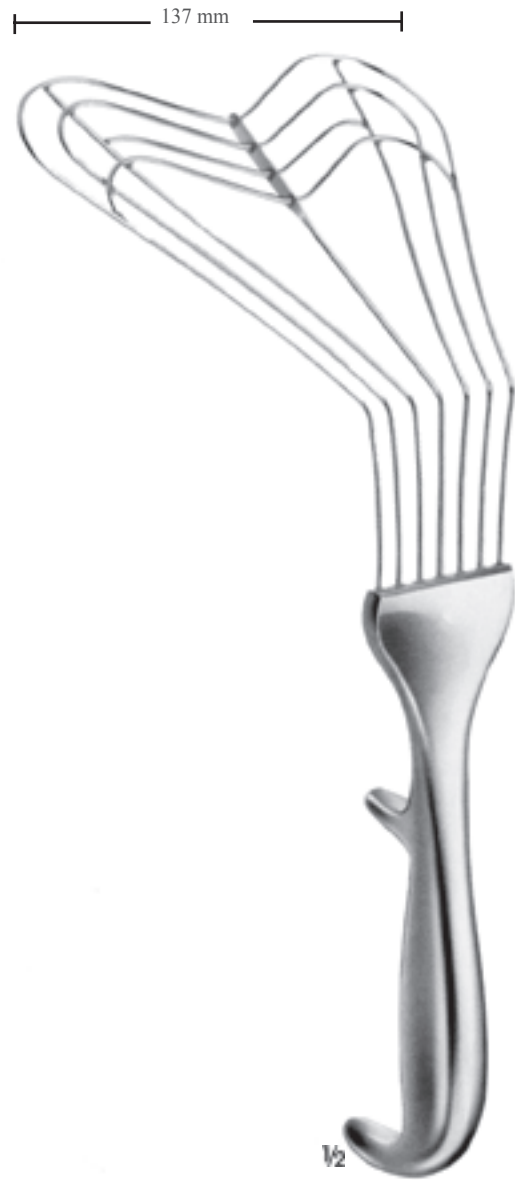

ALLISON
BK-8372
30 cm



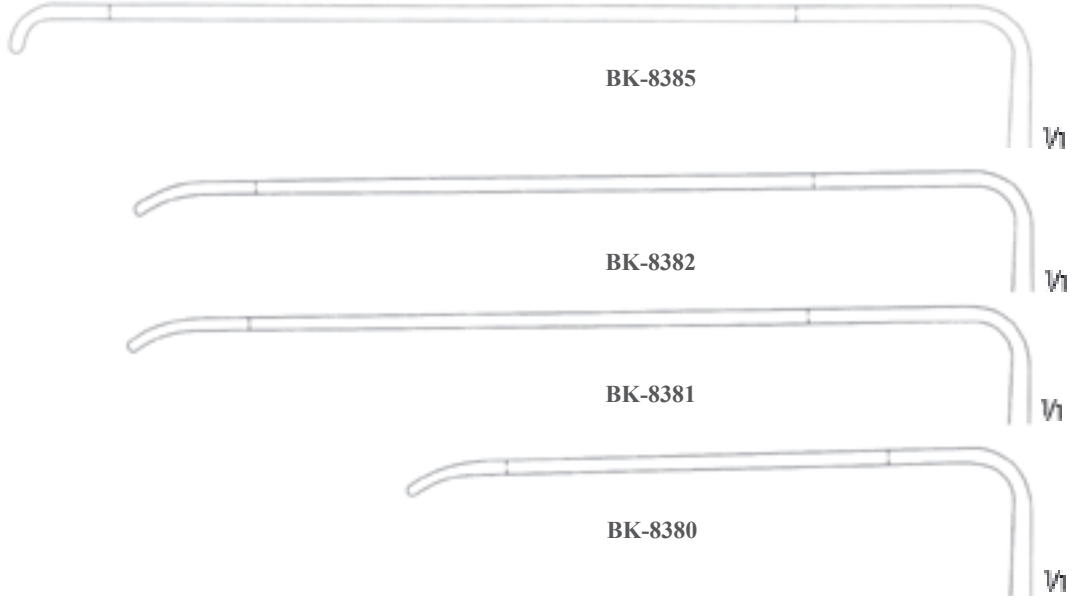

BK-8382
115 x 65 mm

BK-8381
115 x 38 mm

BK-8380
80 x 20 mm

CORYLLOS
BK-8380 - BK-8382
25.5 cm

SAUERBRUCH
BK-8385
26 cm



205 x 29 mm

BK-8390
26 cm



142 x 25 mm

**BRUNNER
BK-8400**
24 cm





DAVIDSON
BK-8396
19.5 cm

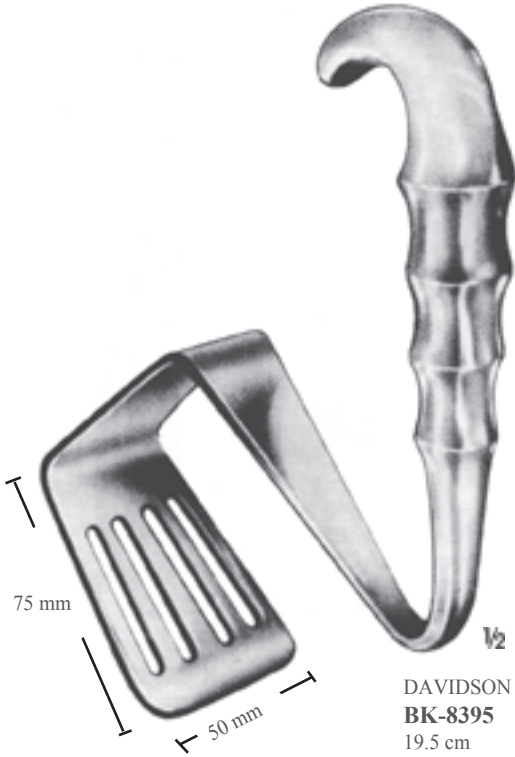

DAVIDSON
BK-8395
19.5 cm

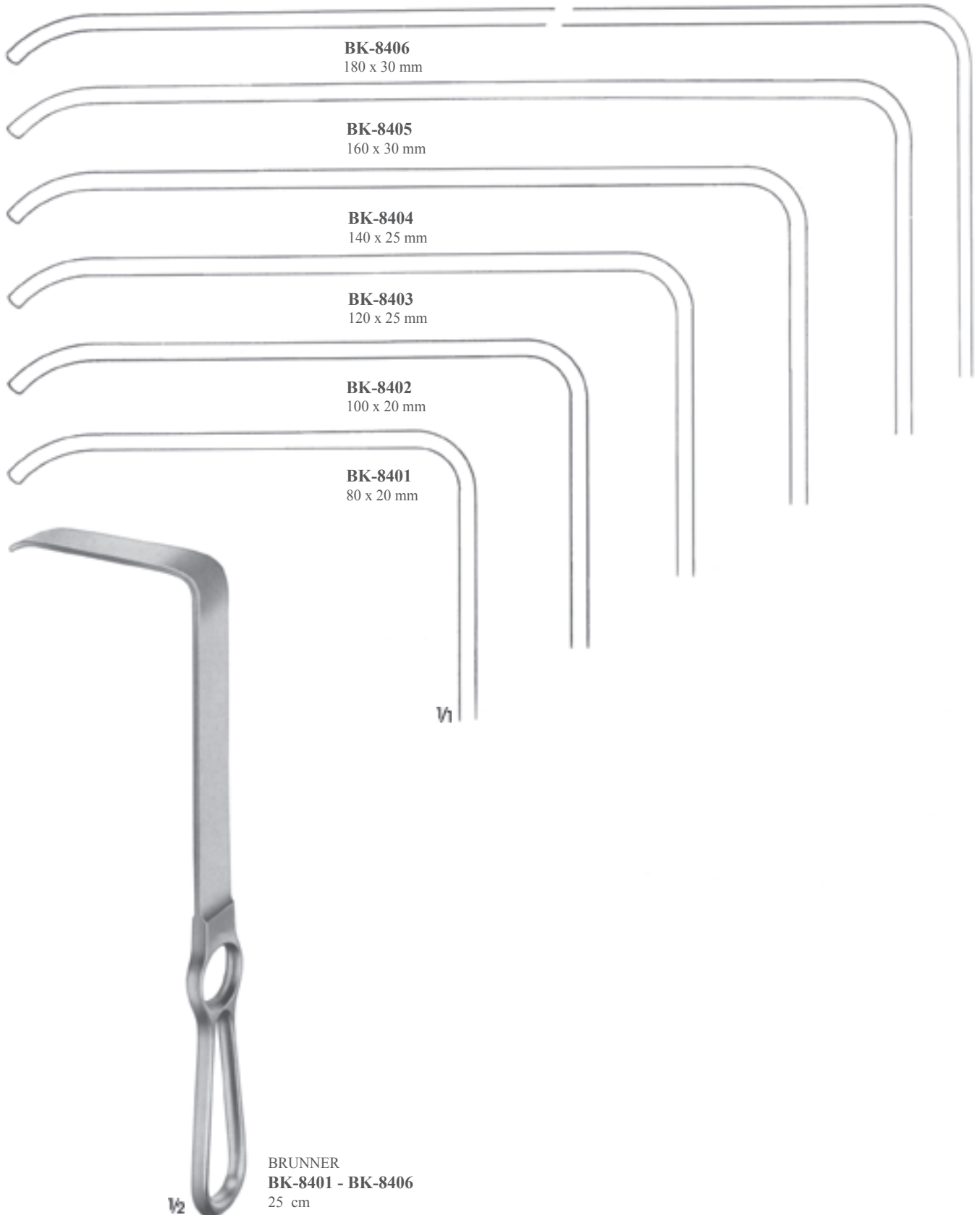

BK-8406
180 x 30 mm

BK-8405
160 x 30 mm

BK-8404
140 x 25 mm

BK-8403
120 x 25 mm

BK-8402
100 x 20 mm

BK-8401
80 x 20 mm

BRUNNER
BK-8401 - BK-8406
25 cm

1/2



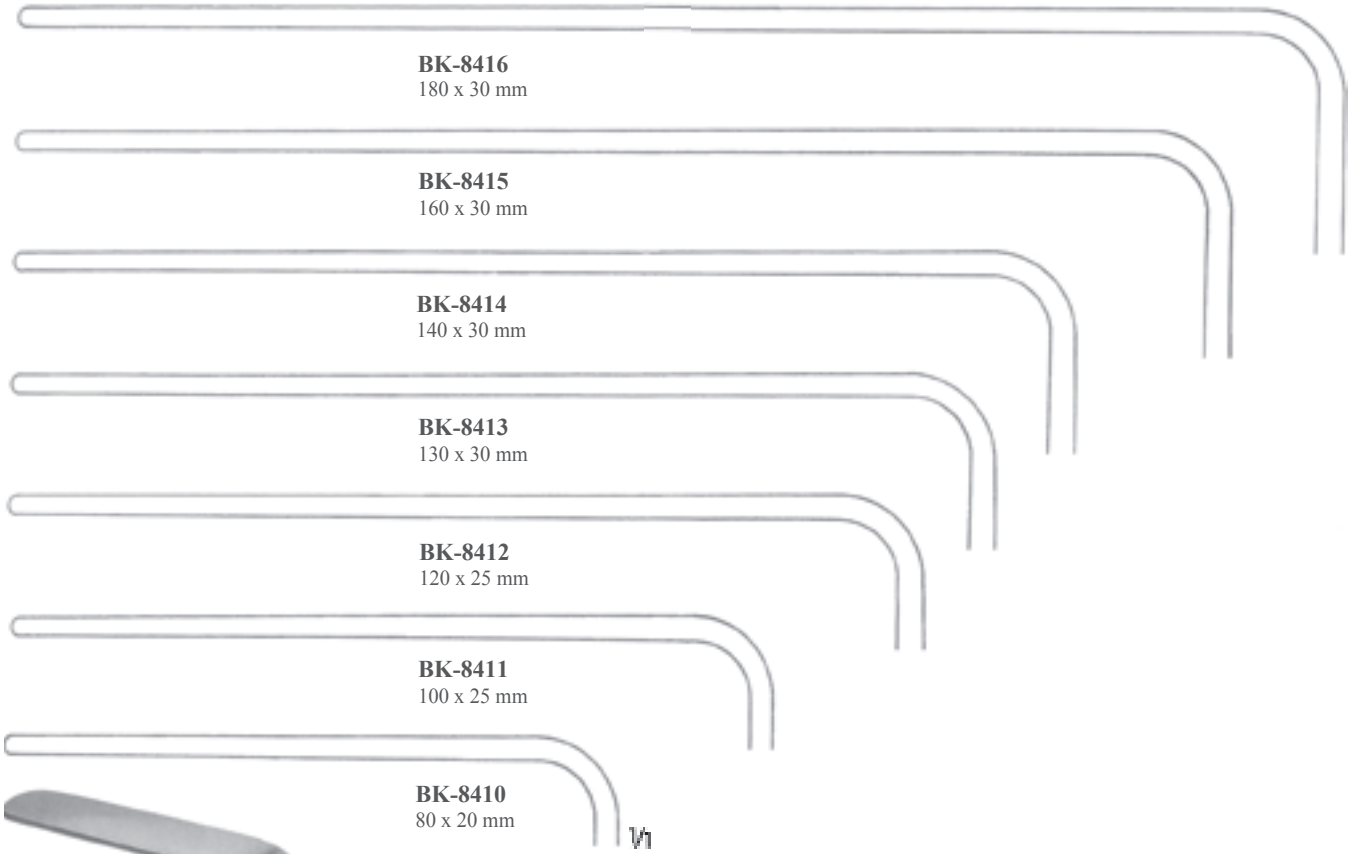

BK-8416
180 x 30 mm

BK-8415
160 x 30 mm

BK-8414
140 x 30 mm

BK-8413
130 x 30 mm

BK-8412
120 x 25 mm

BK-8411
100 x 25 mm

BK-8410
80 x 20 mm



BRUNNER
BK-8410 - BK-8416
27.5 cm





HASSON
BK-8509
Komple/Complete
(BK-8510 - BK-8511)



$\frac{1}{2}$
BK-8510
10 x 160 mm



$\frac{1}{2}$
BK-8511
13 x 180 mm



19 mm

$\frac{1}{2}$
DEAVER
BK-8500
18 cm



22 mm

$\frac{1}{2}$
DEAVER
BK-8501
21.5 cm



25 mm

$\frac{1}{2}$
DEAVER
BK-8502
23.5 cm





1/2

DEEVER
BK-8503
30 cm



25 mm

1/2

DEEVER
BK-8504
31.5 cm



38 mm

1/2

DEAVER
BK-8505
30 cm



50 mm

1/2

DEAVER
BK-8506
31 cm





75 mm

1/2

DEEVER
BK-8507
32 cm



25 mm

1/2

DEEVER
BK-8508
36.5 cm



DEAVER
BK-8520
31 cm



DEAVER
BK-8521
31 cm





50 mm

DEEVER
BK-8522
30.5 cm



75 mm

DEEVER
BK-8523
31 cm



LERICHE
BK-8530
25.5 cm



LERICHE
BK-8535
27.5 cm





KÜMMEL
BK-8540
Bükülebilir/Malleable
28.5 cm



KÖRTE
BK-8555
30 cm



1/2

BK-8745
Prostat ekartör
Prostate retractor
36 cm



1/2

BK-8755
Üretral ekartör
Urethral retractor
39 cm





BK-8633 180 x 50 mm

BK-8632 147 x 50 mm

BK-8631 121 x 50 mm

BK-8630 91 x 35 mm

1/2
MIKULICZ
BK-8630
24 cm

1/2
MIKULICZ
BK-8631 - BK-8632
25 cm
BK-8633
26 cm

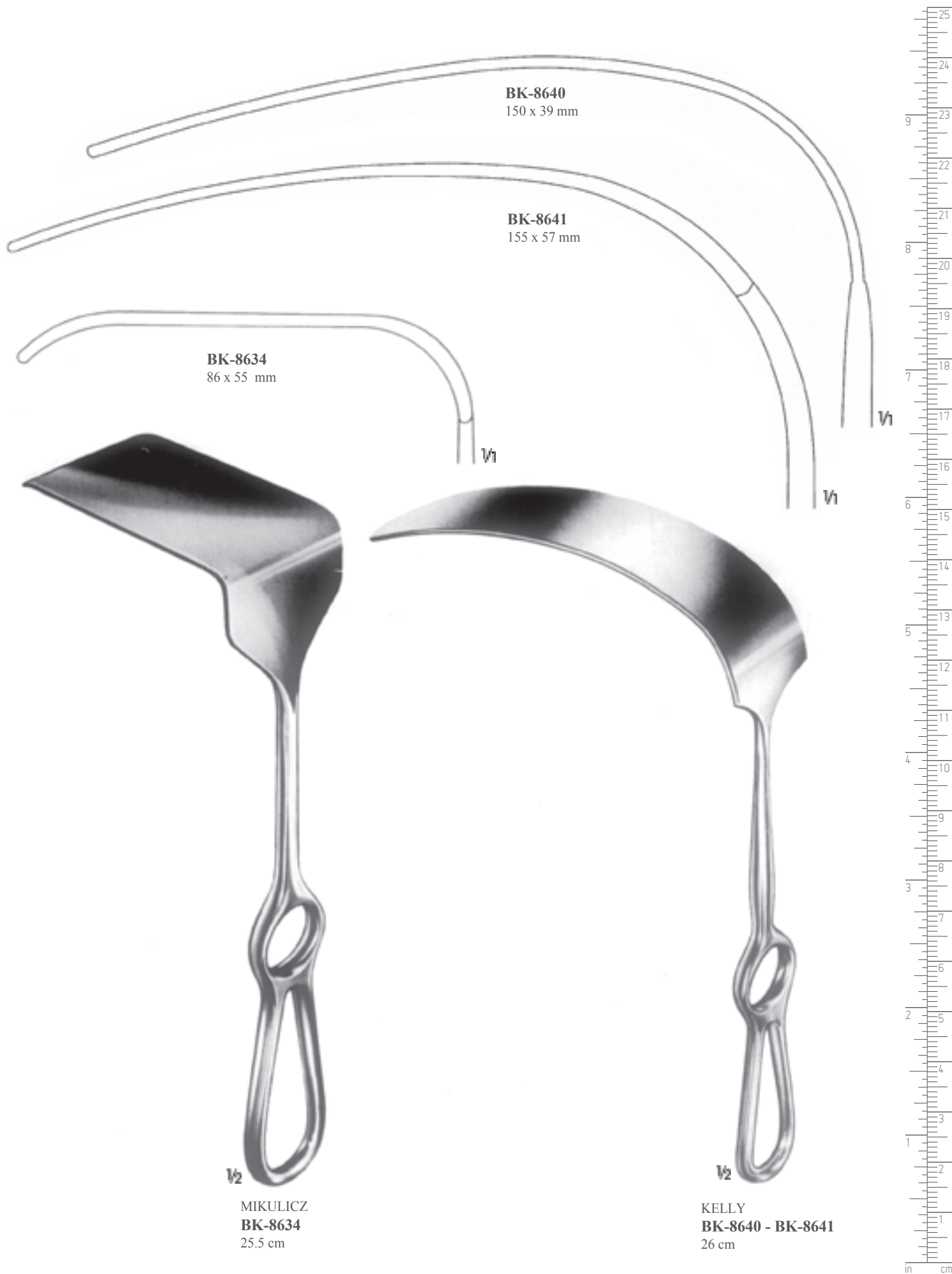

BK-8640
150 x 39 mm

BK-8641
155 x 57 mm

BK-8634
86 x 55 mm

MIKULICZ
BK-8634
25.5 cm

KELLY
BK-8640 - BK-8641
26 cm

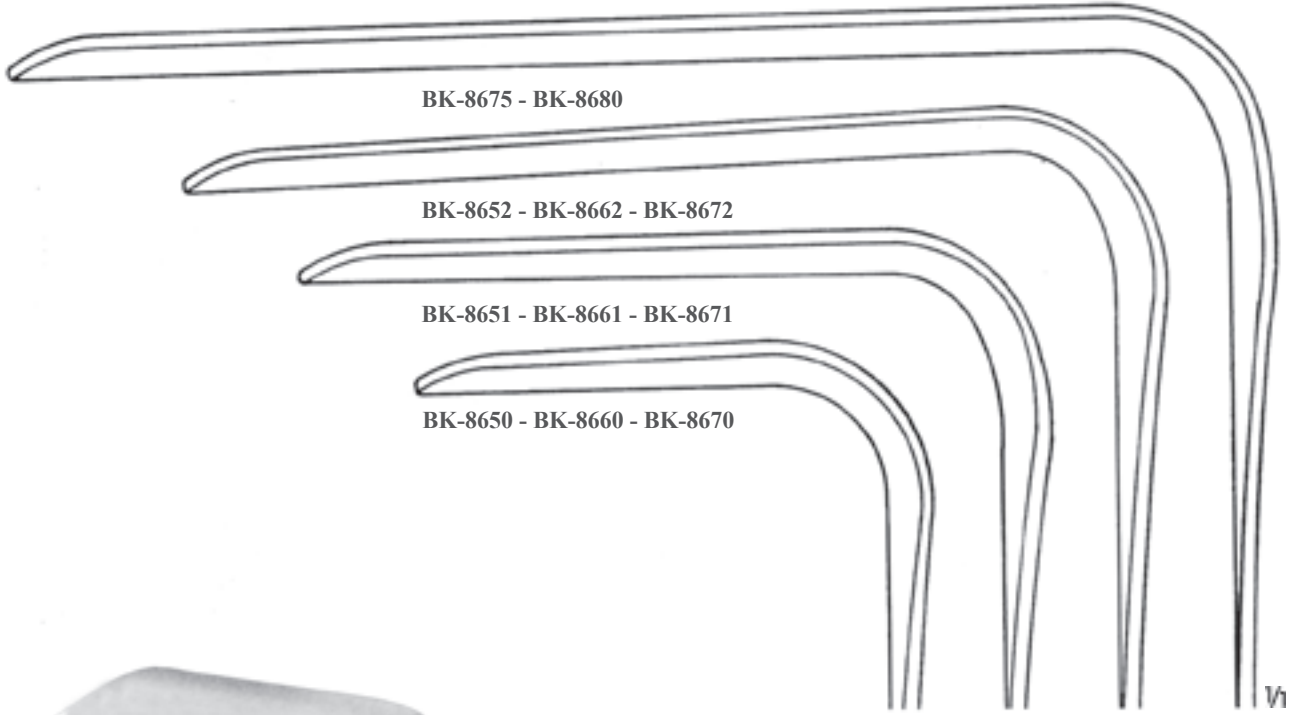

DOYEN
BK-8650 - BK-8680
24 cm

Ağız uzunlukları
Length of blades

60 mm
90 mm
120 mm
160 mm

Ağız genişlikleri
Width of blades

35 mm	45 mm	60 mm
BK-8650	BK-8660	BK-8670
BK-8651	BK-8661	BK-8671
BK-8652	BK-8662	BK-8672
-	BK-8675	BK-8680



TUFFIER
BK-8700
21.5 cm



TUDOR-EDWARDS
BK-8715
20.5 cm





BK-8710
53 x 80 mm

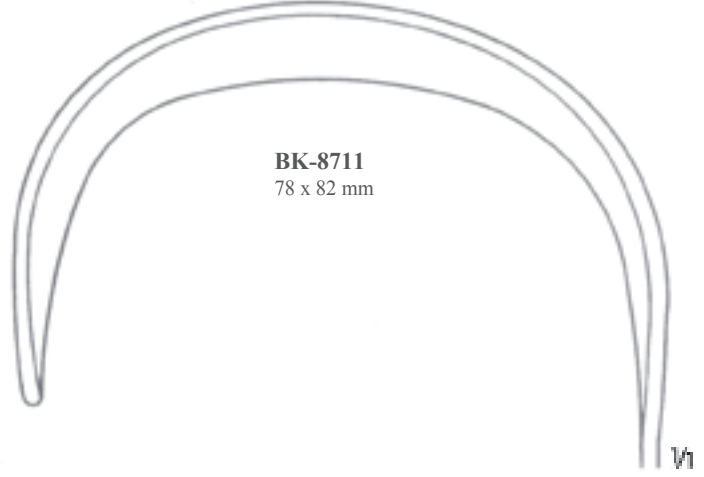

BK-8711
78 x 82 mm



DOYEN
BK-8710
25 cm



DOYEN
BK-8711
26 cm



FRITSCH
BK-8720 - BK-8724
24 cm

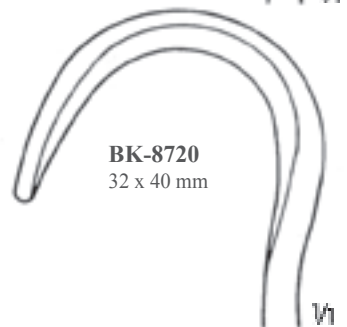
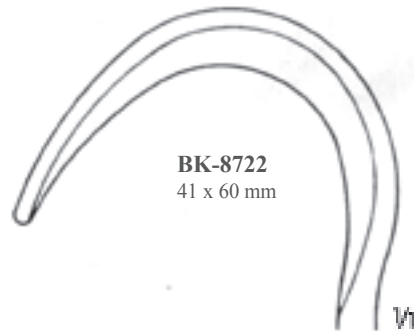
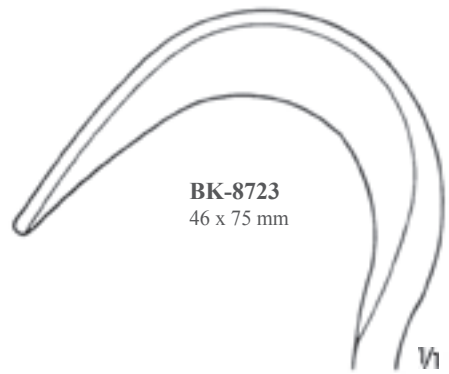
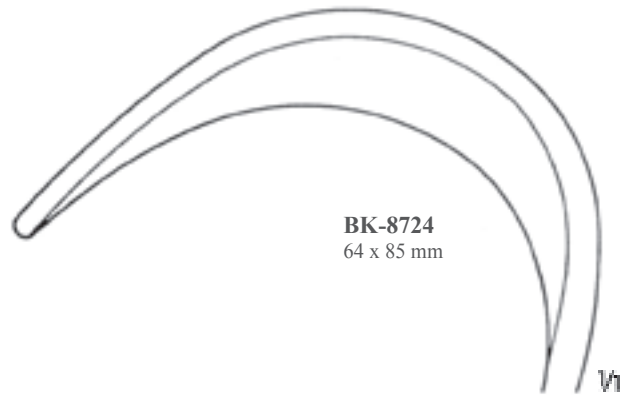

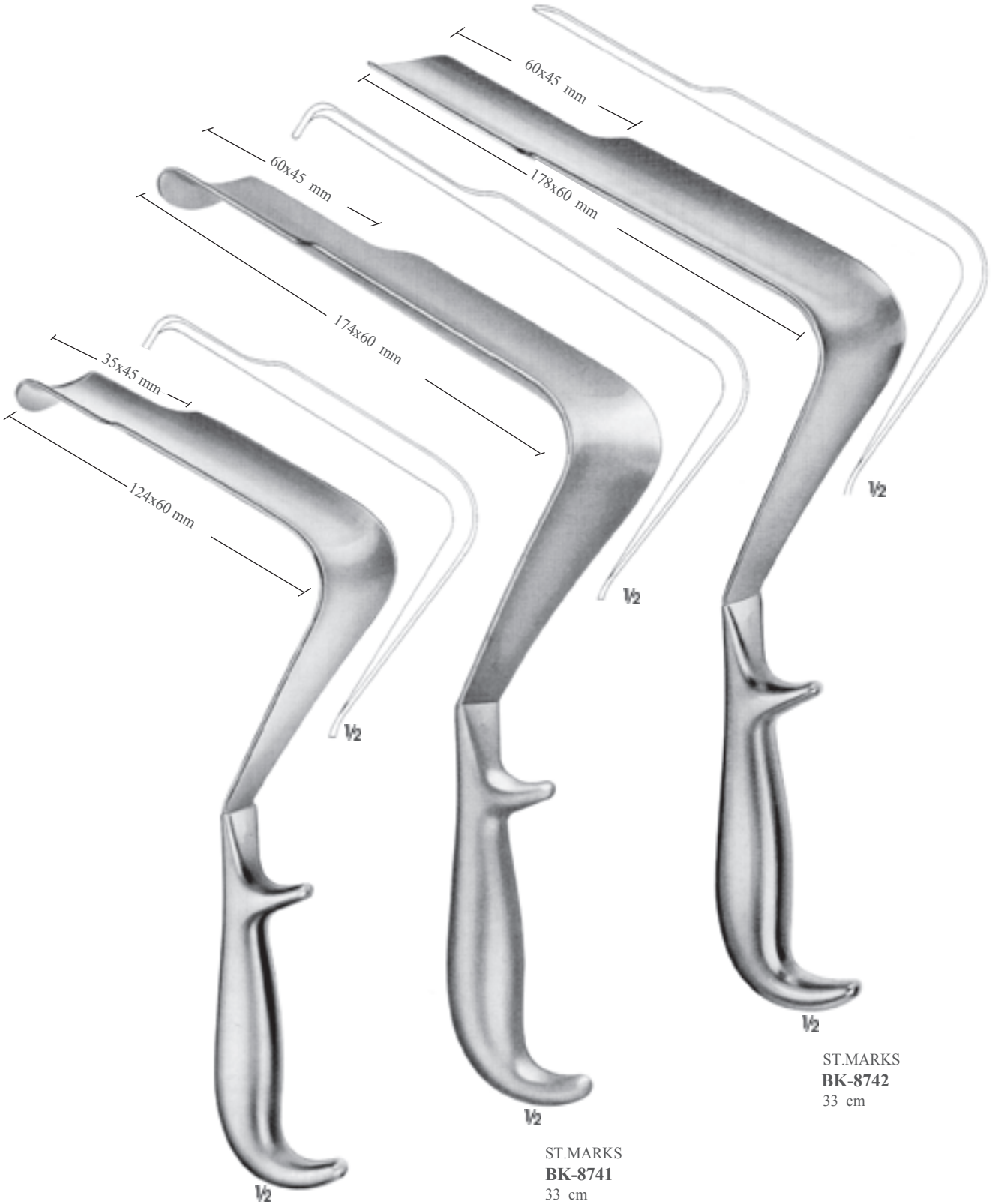

ST.MARKS
BK-8740
29 cm

ST.MARKS
BK-8741
33 cm

ST.MARKS
BK-8742
33 cm



M₂
MÜLLER
BK-8751
27 cm

M₂
MÜLLER
BK-8750
27 cm

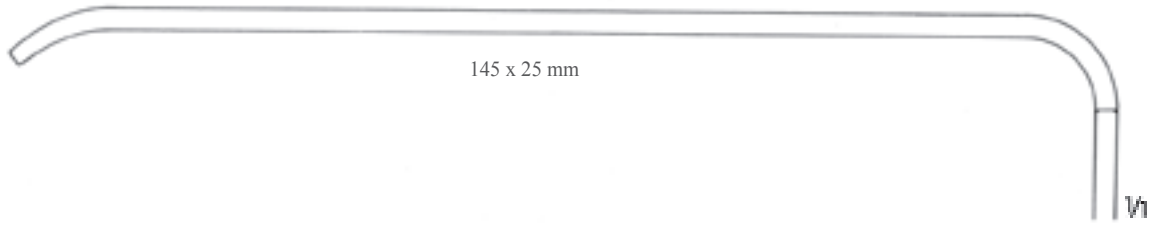

V2

**BRUNNER
BK-8760**
24 cm



V2

**BRUNNER
BK-8765**
Işık taşıyıcılı/With light carrier
24 cm



MIKULICZ
BK-8770 120 x 50 mm
BK-8771 150 x 50 mm
Işık taşıyıcılı/With light carrier
26 cm



53 x 85 mm

DOYEN
BK-8775
25 cm



DOYEN
BK-8776
Işık taşıyıcılı/With light carrier
25 cm





Vs

DOYEN
BK-8780 48 x 90 mm
BK-8781 48 x 105 mm
BK-8782 48 x 120 mm
BK-8783 48 x 135 mm
28 cm



Vs

ROCHARD
BK-8841 48 x 90 mm
BK-8842 48 x 105 mm
BK-8843 48 x 120 mm
BK-8844 48 x 135 mm
BK-8845 48 x 155 mm
31 cm



Vs

BV-4715 Komple /Complete
(BK-8830) Zincir/With chain
(BV-4710) Ağırlık/Weight/645gr.
79 cm



Vs

ROCHARD
(BK-8840 - BK-8841)

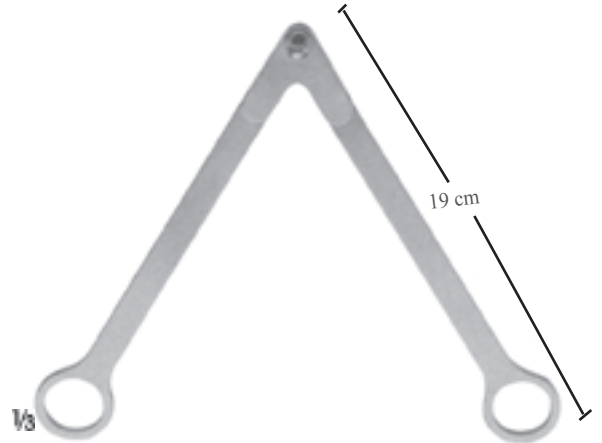

Vs

ROCHARD
BK-8840
Bağlantı tertibatı için BK-8841 - BK-8845
Fixation device for BK-8841 - BK-8845

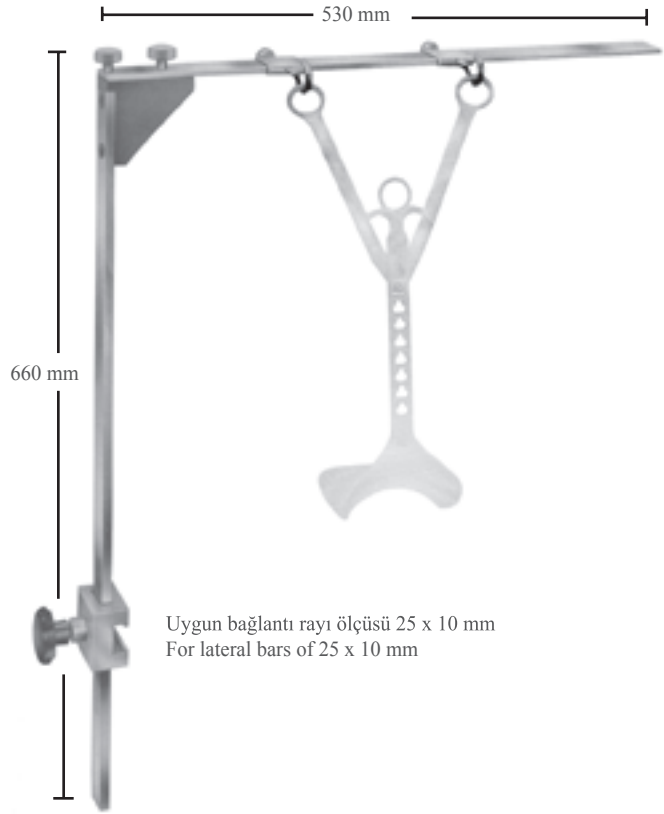

Uygun bağlantı rayı ölçüsü 25 x 10 mm
For lateral bars of 25 x 10 mm

ROCHARD

BK-8846

Daha sağlam bağlantı oluşturmak üzere ameliyat masalarının her iki yan bağlantı rayına bağlanan montaj çerçevesi, sterilizasyon için sökülebilir.

Mounting frame for fastening to both sides of the lateral bars of the operating tables, thus more stability is given, can be dismantled for sterilization.

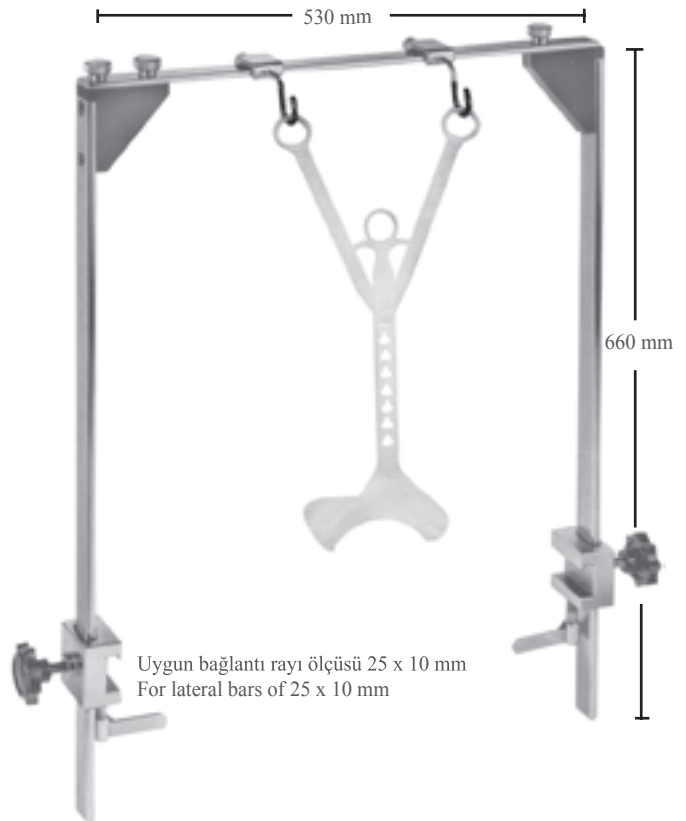

Uygun bağlantı rayı ölçüsü 25 x 10 mm
For lateral bars of 25 x 10 mm

ROCHARD

BK-8847

Daha sağlam bağlantı oluşturmak üzere ameliyat masalarının her iki yan bağlantı rayına bağlanan montaj çerçevesi, sterilizasyon için sökülebilir.

Mounting frame for fastening to both sides of the lateral bars of the operating tables, thus more stability is given, can be dismantled for sterilization.



12-25 mm

BK-8850 200 x 12 mm
BK-8851 200 x 17 mm
BK-8852 250 x 25 mm
Bükülebilir/Malleable



17 mm

TUFFIER
BK-8855
Bükülebilir
Malleable
20 cm



KADER
BK-8550 30 mm
BK-8551 40 mm
27 cm

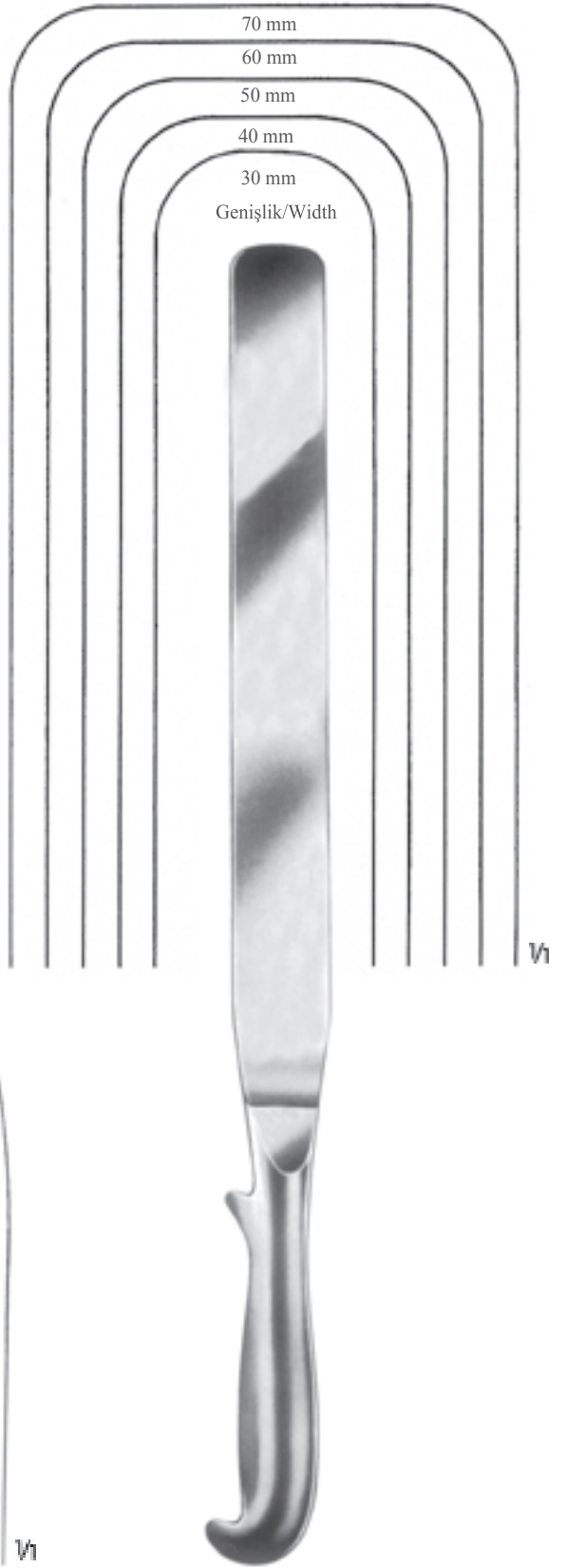

BK-8870 30 mm
BK-8871 40 mm
BK-8872 50 mm
BK-8873 60 mm
BK-8874 70 mm
Bükülebilir/Malleable
41 cm



BV-4801
Kan kaşığı/Blood scoop
Hacmi 50 cc/Volume 50 cc



HABERER
BK-8875
Bükülebilir/Malleable
30.5 cm



RIBBON
BK-8860 25 mm
BK-8861 30 mm
BK-8862 40 mm
BK-8863 50 mm
Bükülebilir/Malleable
33 cm



REVERDIN
BK-8881
28.5 cm



KOCHER
BK-8890
Kaşık şeklinde basırcı
Depressor, spoon shaped
22 cm



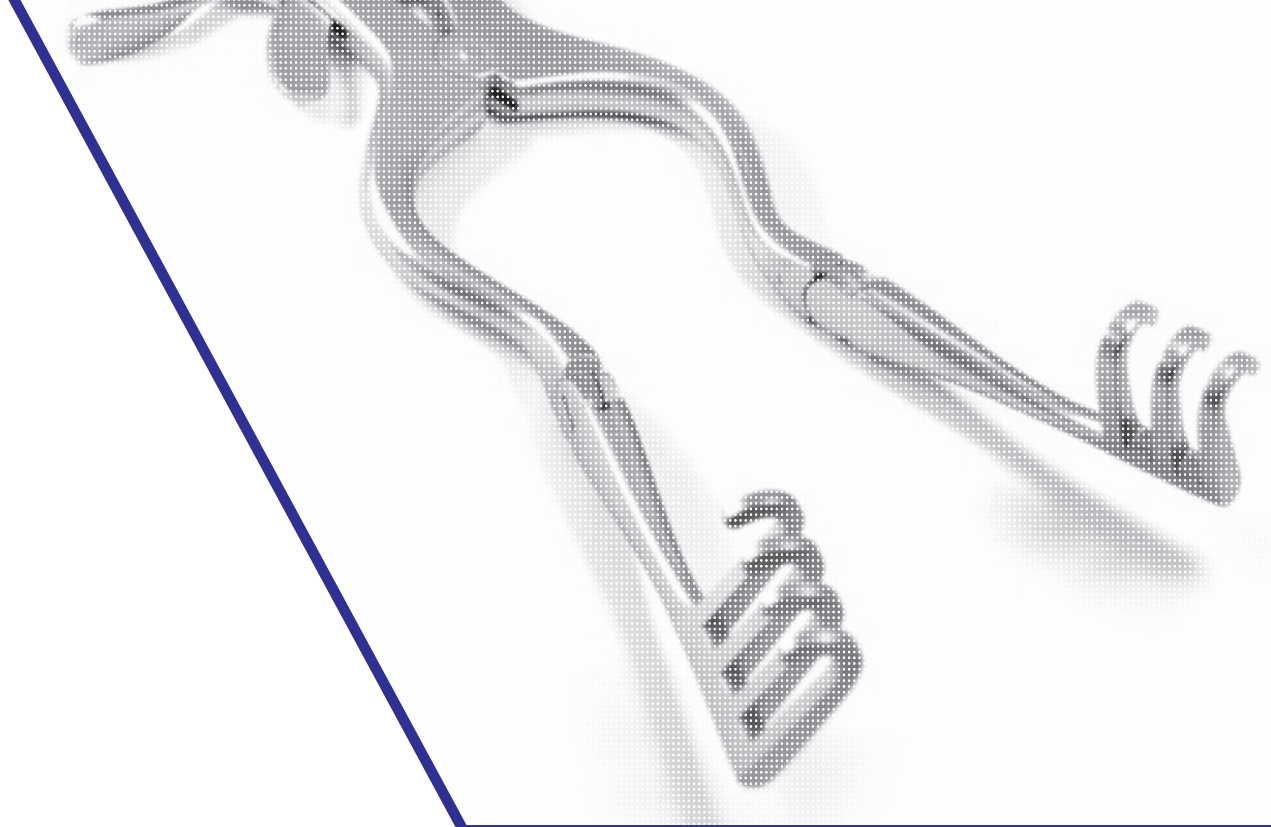

BM

Otomatik Ekartörler
Self-Retaining Retractors

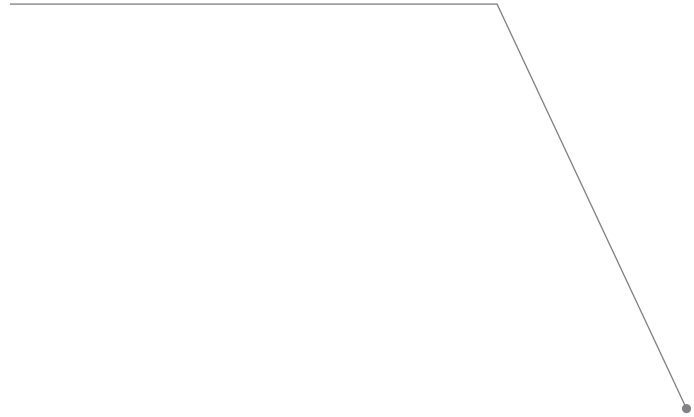





FINSEN
BM-1111
7.5 cm



FINSEN
BM-1112
7 cm



BM-1113
Künt/Blunt 10 cm



BM-1114
Sivri/Sharp
10 cm



ALM
BM-1115 7 cm
BM-1116 10 cm



BM-1960
Otomatik ekartör
Self-retaining retractor
12 cm



ALLPORT
BM-1117
9.5 cm



JANSEN
BM-1118 Sivri/Sharp
10 cm



JANSEN
BM-1119
10 cm



JANSEN
BM-1120
10 cm





WEITLANER
BM-1700 Sivri/Sharp
11 cm



WEITLANER
BM-1701 Künt/Blunt
11 cm



WEITLANER
BM-1702 Yarı Sivri/Semi-sharp
11 cm



WEITLANER
BM-1703 Sivri/Sharp
13 cm



WEITLANER
BM-1704 Künt/Blunt
13 cm



WEITLANER
BM-1705 Yarı sivri/Semi-sharp
13 cm



WEITLANER
BM-1706 Sivri/Sharp
13 cm



WEITLANER
BM-1707 Künt/Blunt
13 cm



WEITLANER
BM-1709 Sivri/Sharp
16.5 cm



WEITLANER
BM-1710 Künt/Blunt
16.5 cm



WEITLANER
BM-1711 Yarı sivri/Semi-sharp
16.5 cm



MOLLISON
BM-1712 Sivri/Sharp
15.5 cm



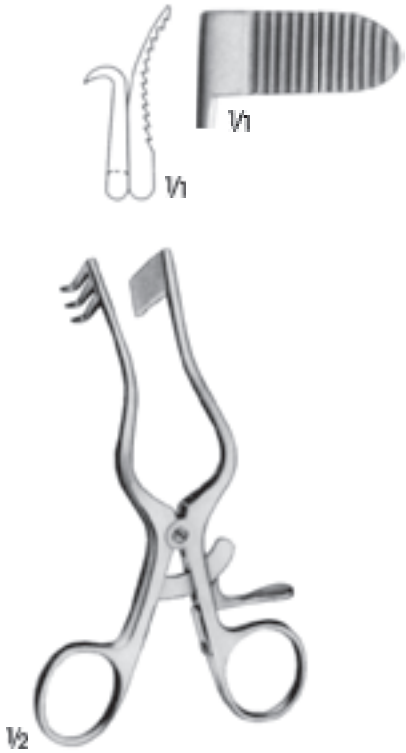

PERKINS
BM-1713
13 cm



PERKINS
BM-1714
13 cm



WULLSTEIN
BM-1717 Sivri/Sharp
13 cm

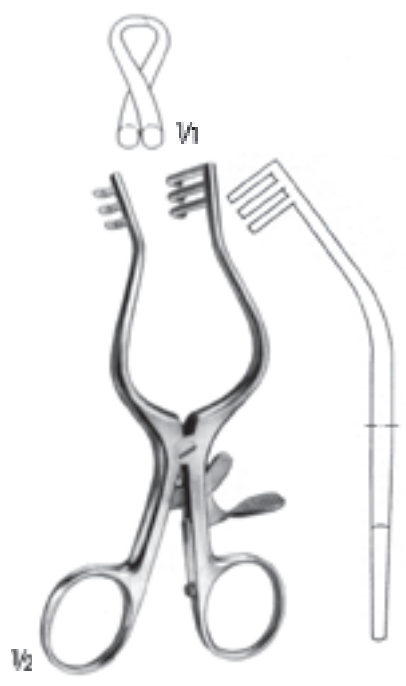

WULLSTEIN
BM-1718 Künt/Blunt
13 cm



JEFFERSON
BM-1719 Künt/Blunt
Eğri/Curved
14 cm



RNTNE
BM-1720 Sivri/Sharp
16.5 cm



HENDERSON
BM-1721 Sivri/Sharp
18 cm



ADSON-BABY
BM-1722 14 cm
BM-1723 16 cm
Yarı sivri/Semi-sharp



ADSON
BM-1726 Sivri/Sharp
BM-1727 Künt/Blunt
16 cm



ADSON
BM-1724 Sivri/Sharp
BM-1725 Künt/Blunt
20 cm



PLESTER
BM-1730 Künt/Blunt
Sol/Left
11 cm



PLESTER
BM-1731 Künt/Blunt
Sağ/Right
11 cm





1/2

PLESTER
BM-1732 Sivri/Sharp
13 cm



1/2

PLESTER
BM-1733 Künt/Blunt
13 cm



1/2

MOLLISON
BM-1734 Sivri/Sharp
14 cm



1/1



1/2

TÜBINGER
BM-1737
16.5 cm



1/1



1/2

IRWIN
BM-1738 Sivri/Sharp
17.5 cm

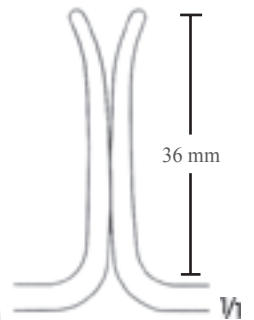

36 mm

1/1



1/2

MAYO-ADAMS
BM-1739
16.5 cm



WEITLANER
BM-1740 Sivri/Sharp
BM-1741 Künt/Blunt
18 cm



BM-1861
Sadece ekartör/Retractor only
Künt/Blunt
17 cm

ALLENBERG
BM-1860 Komple/Complete
BM-1861 Sadece ekartör, күnt
Retractor only, blunt 17 cm
BM-1862 Bleyd/Blade 12 cm
35 x 10 mm - 20 x 12 mm
Karotis ekartör/Carotid retractor
system



TRAVERS
BM-1742
Künt/Blunt
Laminektomi ekartör
Laminectomy retractor
21.5 cm

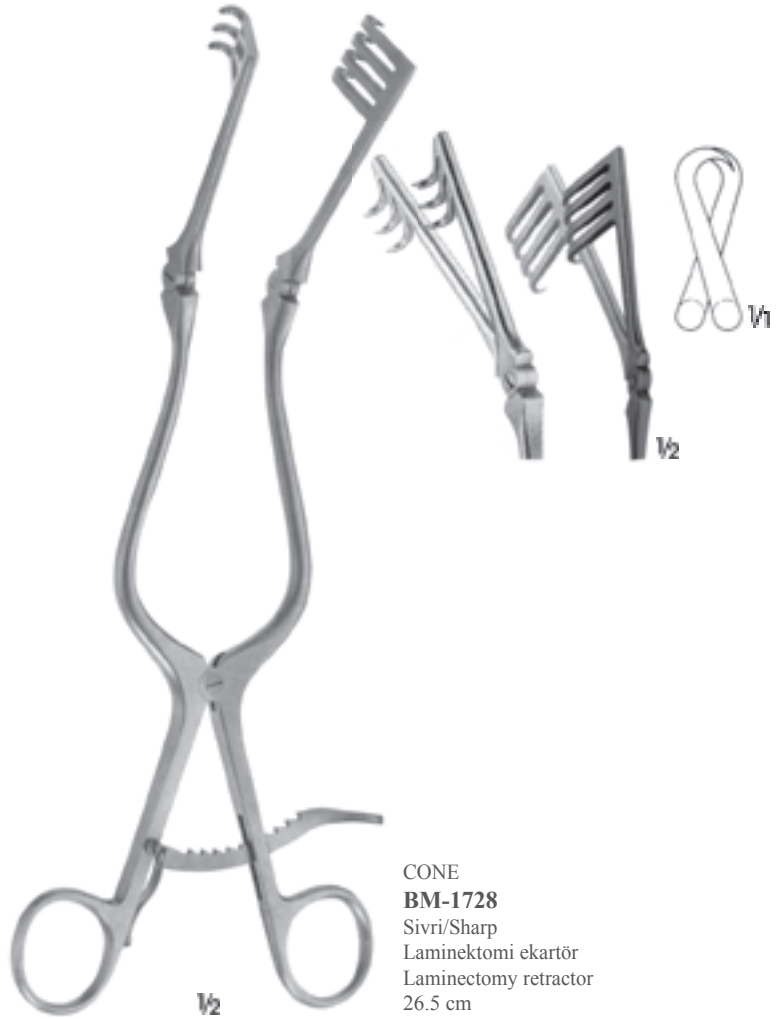

CONE
BM-1728
Sivri/Sharp
Laminektomi ekartör
Laminectomy retractor
26.5 cm





BM-1743
Sivri/Sharp
19.5 cm



BM-1744
Sivri/Sharp
24 cm

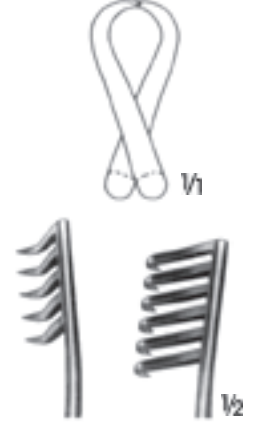

BM-1745
Sivri/Sharp
25.5 cm



BM-1749
Yarı sivri
Semi-sharp
19.5 cm



BM-1750
Yarı sivri
Semi-sharp
24 cm

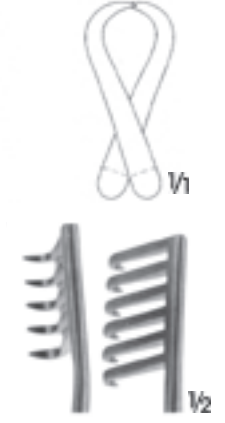

BM-1751
Yarı sivri
Semi-sharp
25.5 cm



WEITLANER
BM-1743 - BM-1751



BM-1746
Künt/Blunt
19.5 cm



BM-1747
Künt/Blunt
24 cm

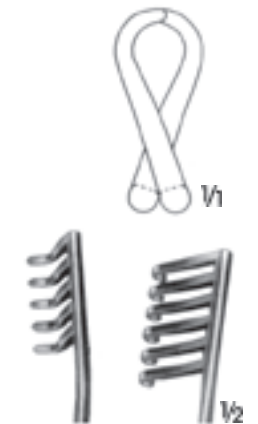

BM-1748
Künt/Blunt
25.5 cm



MISKIMON
BM-1753 Sivri/Sharp
19 cm



NORFOLK-NORWICH
BM-1754 Künt/Blunt
22 cm



ADSON
BM-1755 Sivri/Sharp
26.5 cm



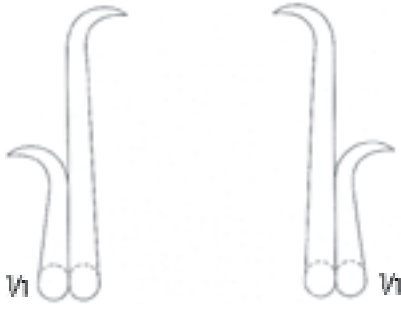

BM-1758
Sivri/Sharp
28 cm



BECKMANN-ADSON
BM-1760
Yarı sivri/Semi-sharp
31 cm

BM-1757
Hemi Laminektomi ekartör/Sivri
Hemi-laminectomy retractor/Sharp
28 cm

BECKMANN-ADSON
BM-1759
Sivri/Sharp
31 cm

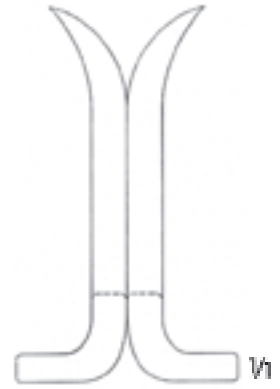
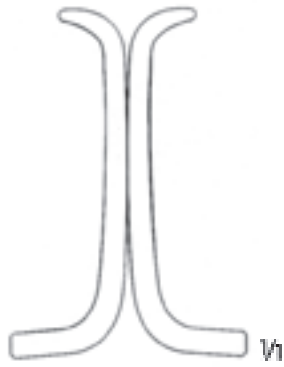

HARLEY JACKSON
BM-1761
Sivri/Sharp
28 cm



ADSON
BM-1762
Yarı Sivri/Semi Sharp
32 cm



BECKMANN-EATON
BM-1764 Sivri/Sharp
32 cm





MEYERDING
BM-1801 - BM-1811
18 cm



MEYERDING
BM-1800 - BM-1810
18 cm

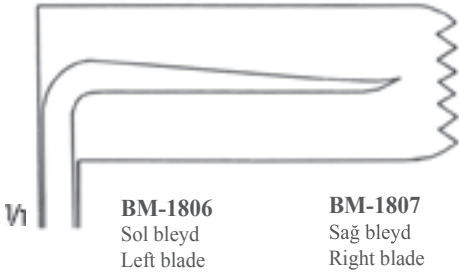

BM-1806
Sol bleyd
Left blade

BM-1807
Sağ bleyd
Right blade

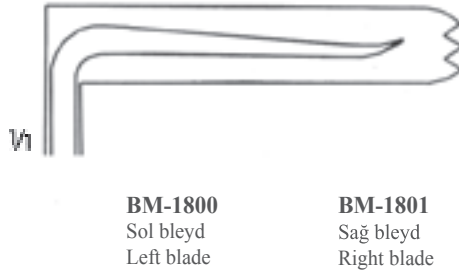

BM-1800
Sol bleyd
Left blade

BM-1801
Sağ bleyd
Right blade

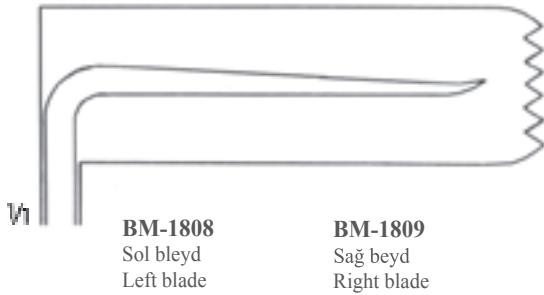

BM-1808
Sol bleyd
Left blade

BM-1809
Sağ bleyd
Right blade

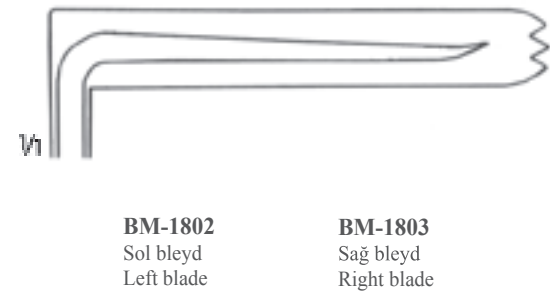

BM-1802
Sol bleyd
Left blade

BM-1803
Sağ bleyd
Right blade

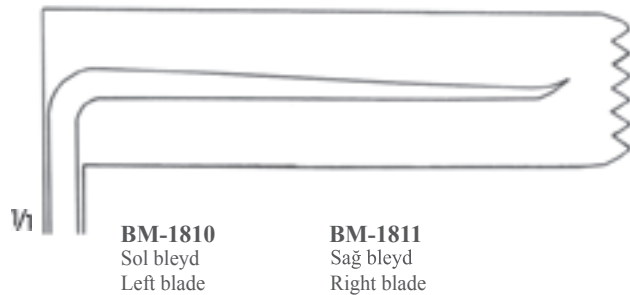

BM-1810
Sol bleyd
Left blade

BM-1811
Sağ bleyd
Right blade

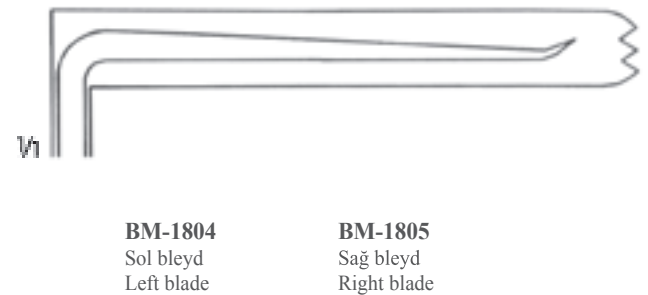

BM-1804
Sol bleyd
Left blade

BM-1805
Sağ bleyd
Right blade



DARLING
BM-1820
18 cm



DARLING
BM-1821
18 cm



MEYERDING
BM-1830 25 x 40 mm
BM-1831 25 x 50 mm
BM-1832 25 x 60 mm
17 cm



BM-1840
17 cm



BM-1841 Sağ/Right
18 cm



BM-1842 Sol/Left
18 cm





DE BAKEY
BM-1875
Kalça kemiği ekartörü, çocuk için
Femur retractor for children
10 cm



DE BAKEY
BM-1880
Kalça kemiği ekartörü
Femur retractor
14.5 cm



GELPI
BM-1885
Vajinal ekartör
Vaginal retractor
13.5 cm



RICHTER
BM-1895
17 cm



GELPI
BM-1890
Cilt ve vajinal ekartör
Skin and vaginal retractor
17.5 cm



JACKSON-BURROWS
BM-1897
Ekartör, künt/Retractor, blunt
18.5 cm



V₂
TROUSSEAU
BV-1100
Trakeal dilatör
Tracheal dilator
12 cm



V₂
LABORDE
BV-1120
Trakeal dilatör
Tracheal dilator
12.5 cm



V₂
LABORDE
BV-1121
Trakeal dilatör/Güçlü model
Tracheal dilator/Strong pattern
13.5 cm



V₂
JOLL (FRIEDMANN)
BM-1898
Tiroid ve vajinal ekartör
Thyroid and vaginal retractor
15.5 cm

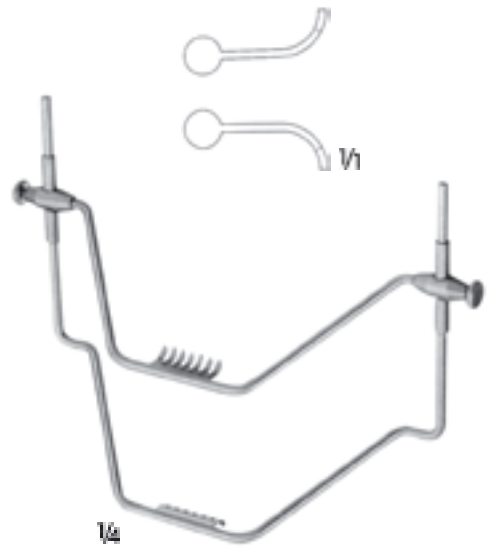

V₁
BM-1910
Tiroid ekartörü
Thyroid retractor





TAYLOR-TURANTAN
BM-2402
20 x 68 x 150 mm

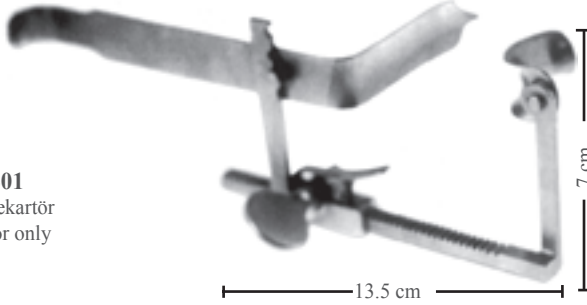

BM-2401
Sadece ekartör
Retractor only



BM-2403 20 x 20 mm
BM-2404 30 x 20 mm
BM-2405 36 x 20 mm

TURANTAN
BM-2400 Komple/Complete
BM-2401
BM-2402 - BM-2403 - BM-2404 - BM-2405

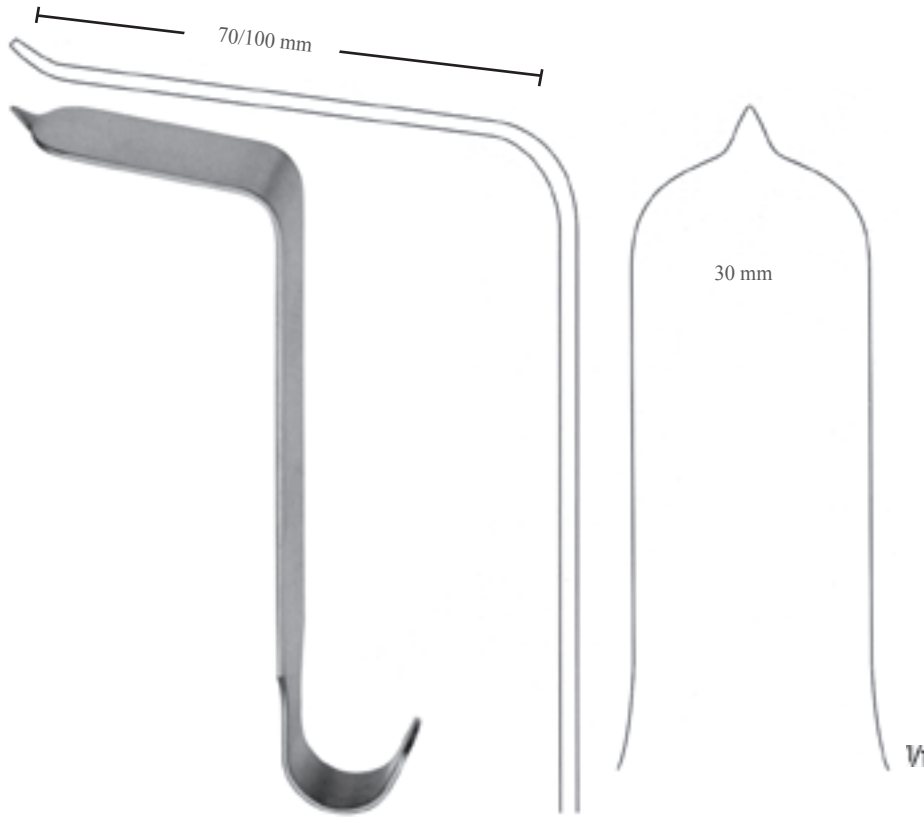

TAYLOR
BM-2410
Bleyd boyu/Blade Size 30 x 70 mm
18.5 cm
BM-2411
Bleyd boy/Blade Size 30 x 100 mm
20 cm



BALLANTINE
BM-2420
32 x 90 mm
23 cm

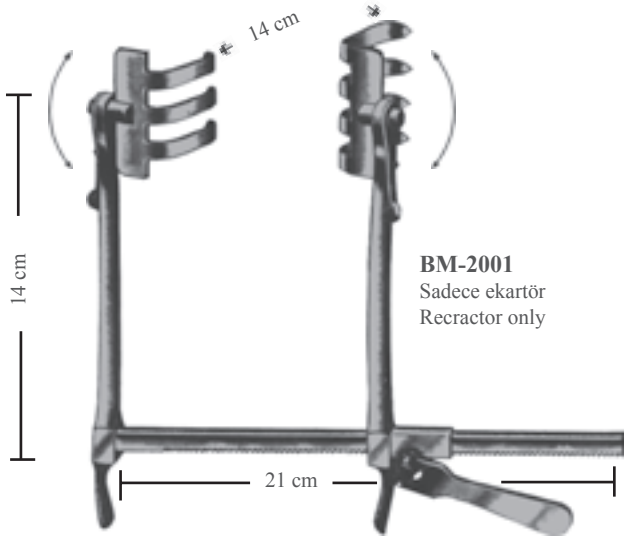

BM-2001
Sadece ekartör
Retractor only

SCOVILLE-RICHTER
BM-2000 Komple/Complete
BM-2001
BM-2002 - BM-2003 - BM-2004
BM-2005 - BM-2006 - BM-2007



BM-2002 48 mm
BM-2003 60 mm



BM-2006 48 x 30 mm
BM-2007 60 x 30 mm



BM-2004 48 x 50 mm
BM-2005 60 x 50 mm



BM-2008 48 x 50 mm
BM-2009 60 x 50 mm



BM-2010 38 x 62 mm



BM-2011 28 x 40 mm

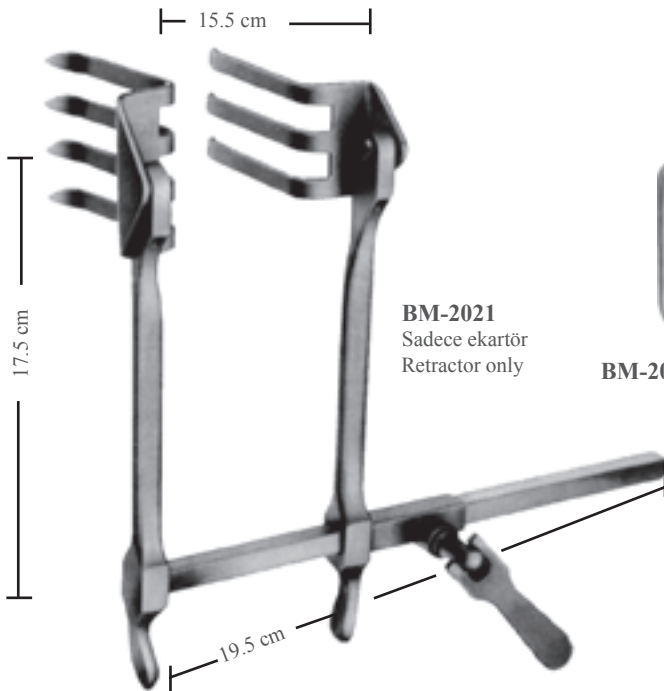

BM-2021
Sadece ekartör
Retractor only

SCOVILLE-RICHTER
BM-2020
Komple/Complete
BM-2021 - BM-2022 - BM-2023 - BM-2024
BM-2025 - BM-2026



BM-2022 62 x 37 mm



BM-2023 62 x 52 mm



BM-2024 47 x 51 mm



BM-2025 30 x 40 mm



BM-2026 37 x 62 mm



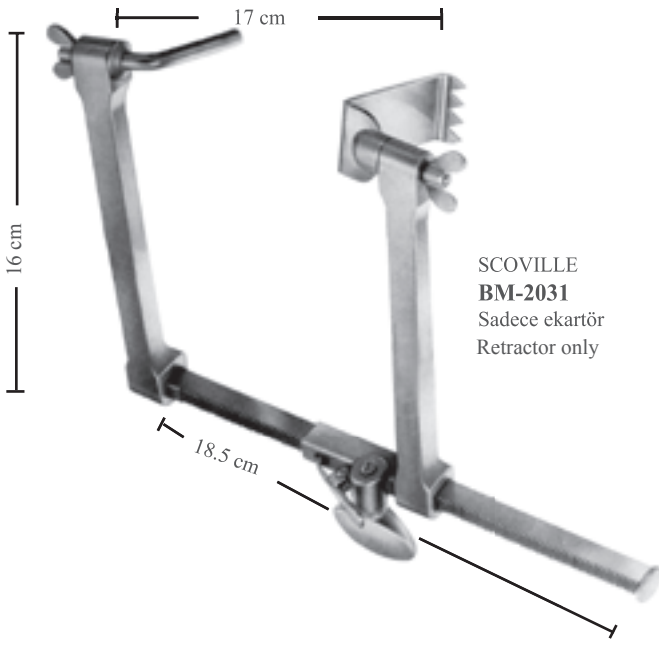

SCOVILLE
BM-2031
Sadece ekartör
Retractor only

SCOVILLE
BM-2033 Komple/Complete
BM-2031
BM-2047 - BM-2048

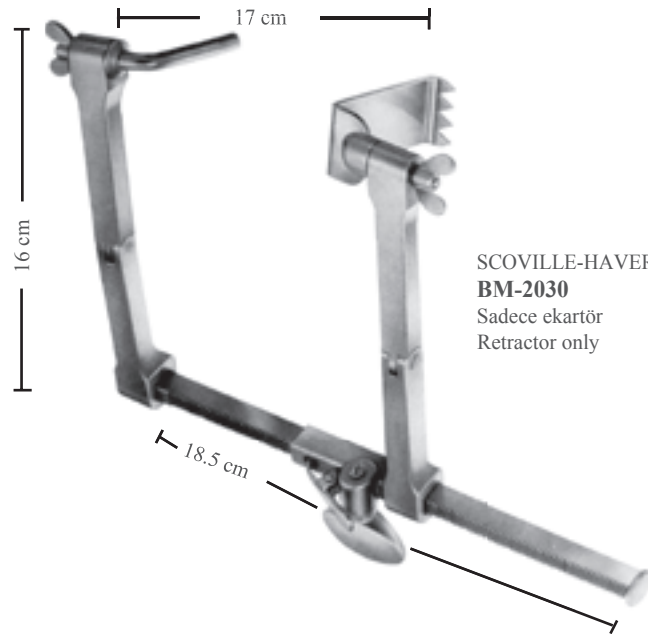

SCOVILLE-HAVERFIELD
BM-2030
Sadece ekartör
Retractor only

SCOVILLE-HAVERFIELD
BM-2032 Komple/Complete
BM-2030
BM-2047 - BM-2048



SCOVILLE
BM-2047 55 mm



SCOVILLE
BM-2048 63 x 25 mm
BM-2039 63 x 51 mm



TAYLOR
BM-2049 47 x 37 mm



TAYLOR
BM-2050 62 x 52 mm



BM-2101
Sadece ekartör
Retractor only

CASPAR
BM-2100 Komple/Complete
BM-2101
BM-2121 - BM-2127 - BM-2135 - BM-2143



BM-2120 38 mm
BM-2121 58 mm
Pimsiz/Without pins



BM-2122 32 x 22 mm
BM-2123 37 x 22 mm
BM-2124 42 x 22 mm
BM-2125 47 x 22 mm
BM-2126 52 x 22 mm
BM-2127 57 x 22 mm
BM-2128 62 x 22 mm
BM-2129 67 x 22 mm
Pimsiz/Without pins



BM-2130 32 x 37 mm
BM-2131 37 x 37 mm
BM-2132 42 x 37 mm
BM-2133 47 x 37 mm
BM-2134 52 x 37 mm
BM-2135 57 x 37 mm
BM-2136 62 x 37 mm
BM-2137 67 x 37 mm
Pimsiz/Without pins



BM-2138 32 x 52 mm
BM-2139 37 x 52 mm
BM-2140 42 x 52 mm
BM-2141 47 x 52 mm
BM-2142 52 x 52 mm
BM-2143 57 x 52 mm
BM-2144 62 x 52 mm
BM-2145 67 x 52 mm
Pimsiz/Without pins





Üniversal Ekartör
Universal Retractor



BM-1970 50 x 44 mm
BM-1971 50 x 54 mm
BM-1972 50 x 74 mm
BM-1973 50 x 89 mm



BV-4830
Ekartörleri yerleştirme kolu
Retractor placing handle

Spinal Ekartör
Spine Retractor

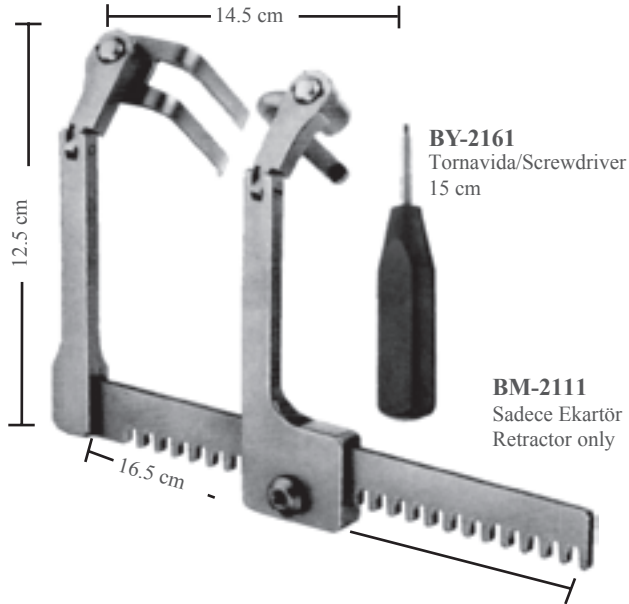

Universal spinal ekartör sistemi
Kendinden tutuculu Caspar universal omurga ekartörü,
güvenli bir ekartasyona izin verir ve sökülüp takılabilir saplar
sayesinde operasyon bölgesinde yer kazandırır.

Universal spinal retractor system
The self-retaining Caspar universal spinal retractor permits safe
retraction and saves in the operation area due to the remov -
able handles.

CASPAR
BM-2110 Komple/Complete
BM-2111 - **BY-2161**
BM-2148 - **BM-2155** - **BM-2163** - **BM-2171**



BM-2146 38 mm
BM-2148 58 mm
Pimli/Pins



BM-2150 32 x 22 mm
BM-2151 37 x 22 mm
BM-2152 42 x 22 mm
BM-2153 47 x 22 mm
BM-2154 52 x 22 mm
BM-2155 57 x 22 mm
BM-2156 62 x 22 mm
BM-2157 67 x 22 mm
Pimli/Pins



BM-2158 32 x 37 mm
BM-2159 37 x 37 mm
BM-2160 42 x 37 mm
BM-2161 47 x 37 mm
BM-2162 52 x 37 mm
BM-2163 57 x 37 mm
BM-2164 62 x 37 mm
BM-2165 67 x 37 mm
Pimli/Pins



BM-2166 32 x 52 mm
BM-2167 37 x 52 mm
BM-2168 42 x 52 mm
BM-2169 47 x 52 mm
BM-2170 52 x 52 mm
BM-2171 57 x 52 mm
BM-2172 62 x 52 mm
BM-2173 67 x 52 mm
Pimli/Pins

HARDBLACK

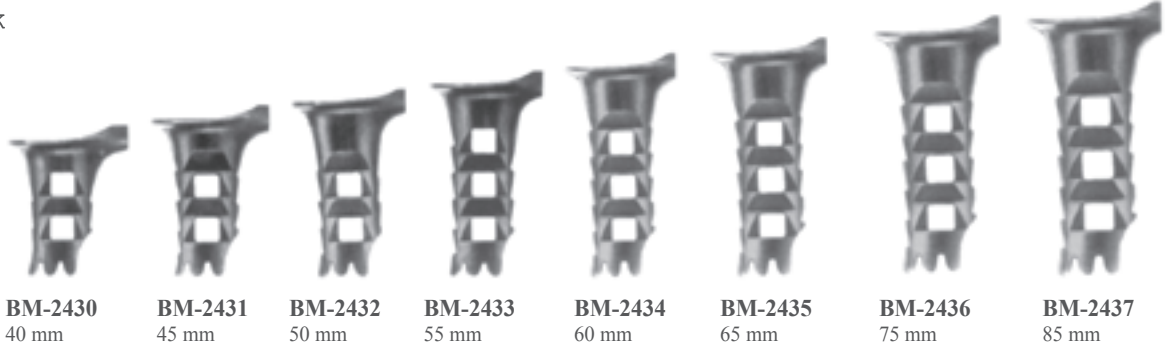

BM-2430 40 mm **BM-2431** 45 mm **BM-2432** 50 mm **BM-2433** 55 mm **BM-2434** 60 mm **BM-2435** 65 mm **BM-2436** 75 mm **BM-2437** 85 mm



CASPAR
BM-2430 - BM-2437

HARDBLACK



BM-2442 35 mm **BM-2443** 40 mm **BM-2444** 45 mm **BM-2445** 50 mm **BM-2446** 55 mm **BM-2447** 60 mm **BM-2448** 65 mm **BM-2449** 75 mm **BM-2450** 85 mm



BM-2460 40 mm **BM-2461** 45 mm **BM-2462** 50 mm **BM-2463** 55 mm **BM-2464** 60 mm **BM-2465** 65 mm **BM-2466** 70 mm

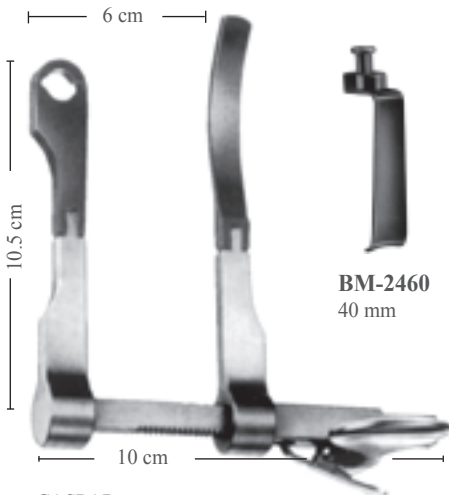

BM-2441 Sadece ekartör
Retractor only

CASPAR
BM-2440 Komple/Complete
BM-2441 - BM-2442 - BM-2450



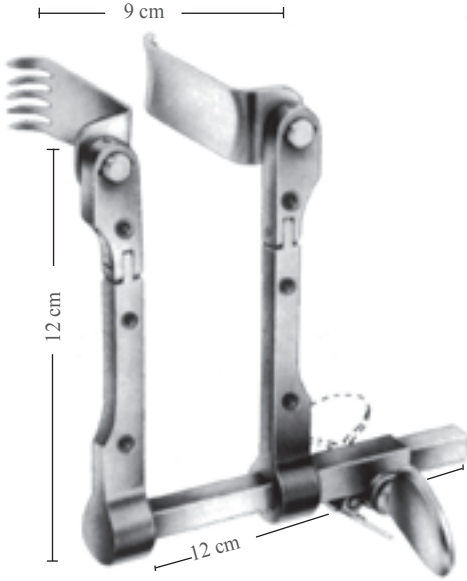

**CASPAR
BM-2180**
BM-2181 Sadece ekartör/Retractor only
(BM-2250 - BM-2254)

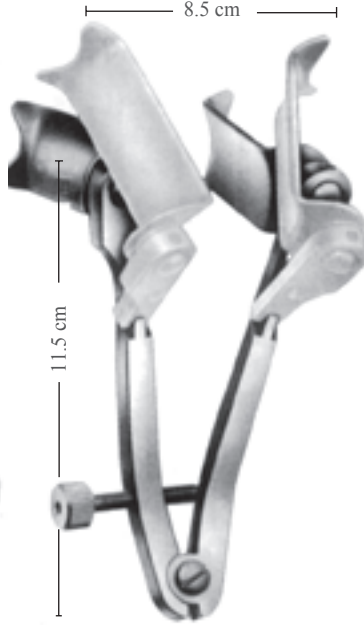

**CASPAR
BM-2190**
BM-2191 Sadece ekartör/Retractor only
(BM-2270 - BM-2275)



**CASPAR
BM-2200**
BM-2201 Sadece ekartör/Retractor only
(BM-2270 - BM-2275)



BM-2210 40 x 23 mm
BM-2211 45 x 23 mm
BM-2212 50 x 23 mm
BM-2213 55 x 23 mm
BM-2214 60 x 23 mm



BM-2250 40 x 23 mm
BM-2251 45 x 23 mm
BM-2252 50 x 23 mm
BM-2253 55 x 23 mm
BM-2254 60 x 23 mm



BM-2270 40 x 23 mm
BM-2271 45 x 23 mm
BM-2272 50 x 23 mm
BM-2273 55 x 23 mm
BM-2274 60 x 23 mm
BM-2275 65 x 23 mm



BM-2215 40 x 25 mm
BM-2216 45 x 25 mm
BM-2217 50 x 25 mm
BM-2218 55 x 25 mm
BM-2219 60 x 25 mm



BM-2255 40 x 25 mm
BM-2256 45 x 25 mm
BM-2257 50 x 25 mm
BM-2258 55 x 25 mm
BM-2259 60 x 25 mm



BM-2276 30 x 24 mm
BM-2277 35 x 24 mm
BM-2278 40 x 24 mm
BM-2279 45 x 24 mm
BM-2280 50 x 24 mm
BM-2281 55 x 24 mm
BM-2282 60 x 24 mm
BM-2283 65 x 24 mm
BM-2284 70 x 24 mm
BM-2285 75 x 24 mm
Titanyum bleyd
Titanium blades



BM-2312 25 x 24 mm
BM-2313 30 x 24 mm
BM-2314 35 x 24 mm
BM-2315 40 x 24 mm
BM-2316 45 x 24 mm
BM-2317 50 x 24 mm
BM-2318 55 x 24 mm
BM-2319 60 x 24 mm
BM-2320 65 x 24 mm
BM-2321 70 x 24 mm
Titanyum bleyd
Titanium blades



BM-2322 25 x 24 mm
BM-2323 30 x 24 mm
BM-2324 35 x 24 mm
BM-2325 40 x 24 mm
BM-2326 45 x 24 mm
BM-2327 50 x 24 mm
BM-2328 55 x 24 mm
BM-2329 60 x 24 mm
BM-2330 65 x 24 mm
BM-2331 70 x 24 mm
Titanyum bleyd
Titanium blades



BM-2310 50 x 25 mm
BM-2311 60 x 25 mm



BD-8625
Bleyd tutma
pensi
Blade ejector
forceps
11.5 cm



BM-2182
Çift hareketli servikal ekartör
Double hinged cervical retractor



BM-2202
Çift hareketli karşı ekartör
Double hinged retractor used for
longitudinal retraction



BM-2192
Karşı ekartör
Counter retractor



BM-2238 30 x 24 mm
BM-2239 35 x 24 mm
BM-2240 40 x 24 mm
BM-2241 45 x 24 mm
BM-2242 50 x 24 mm
BM-2243 55 x 24 mm
BM-2244 60 x 24 mm
BM-2245 65 x 24 mm
BM-2246 70 x 24 mm
Titanyum orta bleyd
Medial blades titanium



BM-2260 30 x 24 mm
BM-2261 35 x 24 mm
BM-2262 40 x 24 mm
BM-2263 45 x 24 mm
BM-2264 50 x 24 mm
BM-2265 55 x 24 mm
BM-2266 60 x 24 mm
BM-2267 65 x 24 mm
BM-2268 70 x 24 mm
Titanyum yan bleyd
Lateral blades titanium



BM-2286 35 x 24 mm
BM-2287 40 x 24 mm
BM-2288 45 x 24 mm
BM-2289 50 x 24 mm
BM-2290 55 x 24 mm
BM-2291 60 x 24 mm
BM-2292 65 x 24 mm
BM-2293 70 x 24 mm
BM-2294 75 x 24 mm
Titanyum künt bleyd
Blunt blades titanium



BM-2332 30 x 24 mm
BM-2333 35 x 24 mm
BM-2334 40 x 24 mm
BM-2335 45 x 24 mm
BM-2336 50 x 24 mm
BM-2337 55 x 24 mm
BM-2338 60 x 24 mm
BM-2339 65 x 24 mm
BM-2340 70 x 24 mm
Titanyum orta bleyd
Medial blades titanium



BM-2300 30 x 24 mm
BM-2301 35 x 24 mm
BM-2302 40 x 24 mm
BM-2303 45 x 24 mm
BM-2304 50 x 24 mm
BM-2305 55 x 24 mm
BM-2306 60 x 24 mm
BM-2307 65 x 24 mm
BM-2308 70 x 24 mm
Titanyum yan bleyd
Lateral blades titanium



BM-2351 35 x 24 mm
BM-2352 40 x 24 mm
BM-2353 45 x 24 mm
BM-2354 50 x 24 mm
BM-2355 55 x 24 mm
BM-2356 60 x 24 mm
BM-2357 65 x 24 mm
BM-2358 70 x 24 mm
BM-2359 75 x 24 mm
Titanyum künt bleyd
Blunt blades titanium



BM-2368 25 x 19 mm
BM-2369 30 x 19 mm
BM-2370 35 x 19 mm
BM-2371 40 x 19 mm
BM-2372 45 x 19 mm
BM-2373 50 x 19 mm
BM-2374 55 x 19 mm
BM-2375 60 x 19 mm
Titanyum dişli bleyd
Teeth blades titanium



BM-2383 25 x 19 mm
BM-2384 30 x 19 mm
BM-2385 35 x 19 mm
BM-2386 40 x 19 mm
BM-2387 45 x 19 mm
BM-2388 50 x 19 mm
BM-2389 55 x 19 mm
BM-2390 60 x 19 mm
Titanyum künt bleyd
Blunt blades titanium



BV-4820
Bleyd tutucu elçek
Handle for blades with side load
attachment





CLOWARD
BM-2471
Sadece ekartör
Retractor only
25 cm



CLOWARD
BM-2490
Sadece ekartör
Retractor only
15 cm

CLOWARD
BM-2470 Komple/Complete
BM-2471
BM-2472 - BM-2498

CLOWARD
BM-2491 Komple/Complete
BM-2490
BM-2494 - BM-2495 - BM-2496
BM-2497 - BM-2498

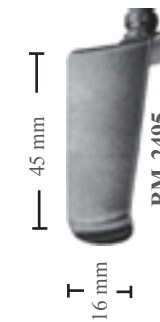
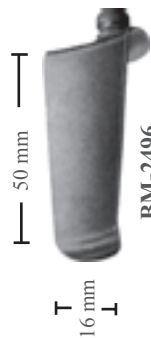
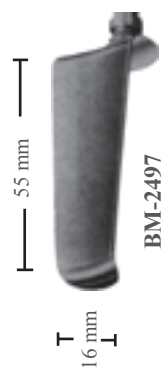
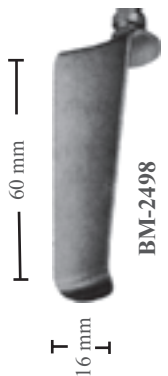
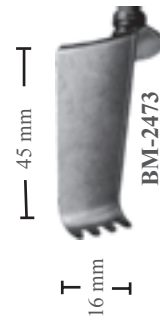
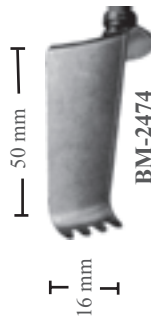
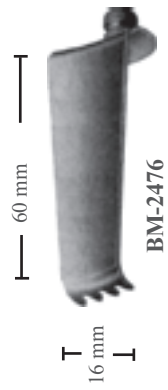



CLOWARD
BM-2530
15.5 cm



CLOWARD
BM-2535
13.5 cm



INGE
BM-2540
17 cm

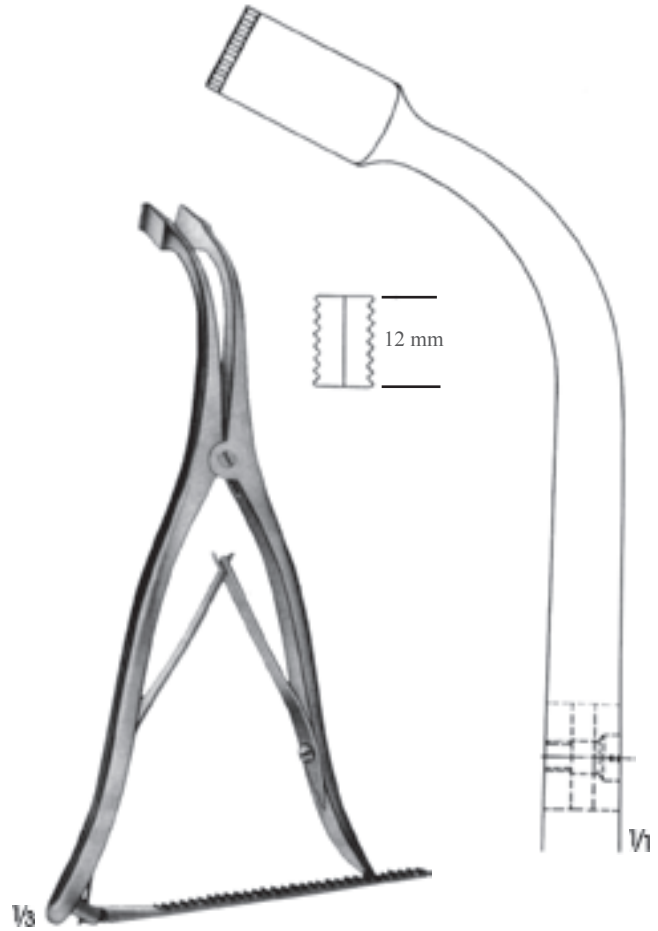

INGE
BM-2550
27.5 cm



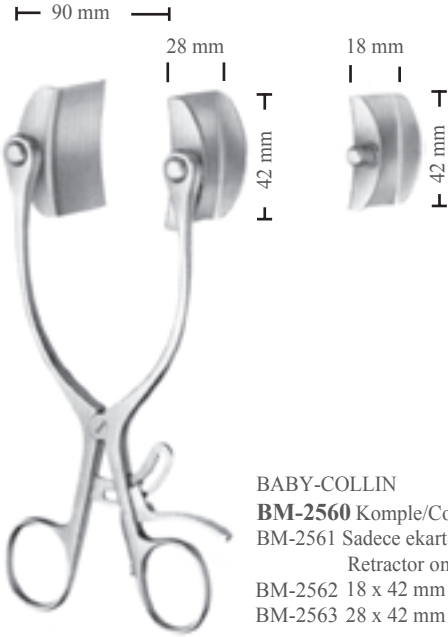

BABY-COLLIN
BM-2560 Komple/Complete
BM-2561 Sadece ekartör
Retractor only
BM-2562 18 x 42 mm bleyd çift/blades pair
BM-2563 28 x 42 mm bleyd çift/blades pair



COLLIN
BM-2570 Komple/Complete
BM-2571 Sadece ekartör
Retractor only
BM-2750 Yan bleyd çift
Lateral blades pair

BM-2593 13.5 cm
BM-2594 16 cm



COLLIN
BM-2590 - BM-2592



COLLIN
BM-2580 - BM-2581

Sadece ekartör Retractor only	BM-2590 BM-2593	BM-2591 BM-2594	BM-2592 BM-2594
Yan bleyd (çift) Lateral blades (pair)	BM-2750 37 x 62 mm	BM-2751 37 x 80 mm	BM-2752 37 x 98 mm
Orta bleyd Center blade	BM-2781 54 x 55 mm	BM-2782 54 x 67 mm	BM-2783 52 x 76 mm

Sadece ekartör Retractor only	BM-2580 BM-2582	BM-2581 BM-2582
Yan bleyd (çift) Lateral blades (pair)	BM-2754 48 x 59 mm	BM-2753 61 x 80 mm
Orta bleyd Center blade	BM-2780 63 x 74 mm	BM-2780 63 x 74 mm

32 cm



RICARD
BM-2610 - BM-2611

Sadece ekartör
Retractor only
Yan bleyd (çift)
Lateral blades (pair)
Orta bleyd
Center blade

BM-2610
BM-2612
BM-2755
58 x 80 mm
BM-2785
54 x 70 mm

BM-2611
BM-2612
BM-2756
72 x 84 mm
BM-2786
72 x 90 mm

26.5 cm



ROBIN-MASSE
BM-2600
Komple/Complete

Sadece ekartör
Retractor only
Yan bleyd (çift)
Lateral blades (pair)
Orta bleyd
Center blade

BM-2601
BM-2750
37 x 62 mm
BM-2784
38 x 68 mm

27.5 cm



HOLZBACH
BM-2620
Komple/Complete

Sadece ekartör
Retractor only
Yan bleyd (çift)
Lateral blades (pair)
Orta bleyd
Center blade

BM-2621
BM-2757
59 x 80 mm
BM-2787
74 x 82 mm



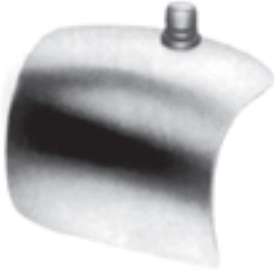

BM-2754 48 x 59 mm
BM-2755 58 x 80 mm
BM-2756 72 x 84 mm
Yan bleyd (çift)
Lateral blades (pair)

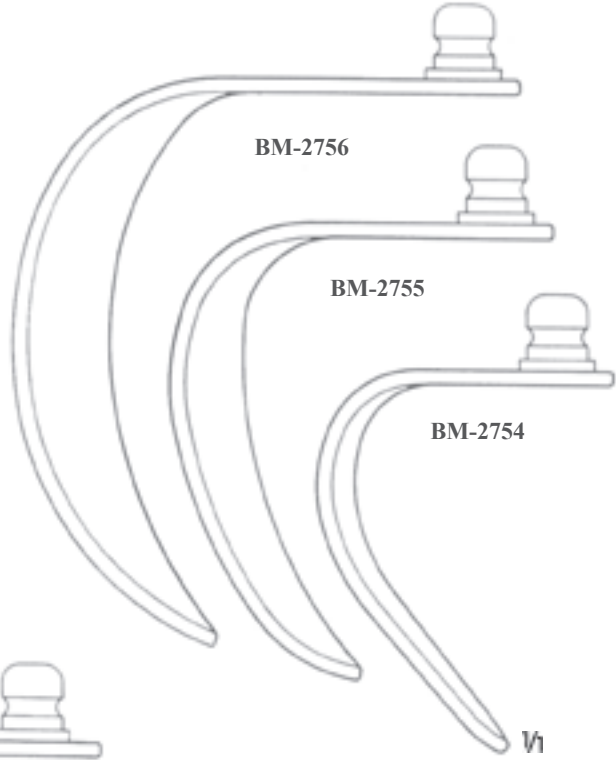

BM-2756

BM-2755

BM-2754



BM-2757 59 x 80 mm
Yan bleyd (çift)
Lateral blades (pair)



BM-2757



BM-2750 37 x 62 mm
BM-2751 37 x 80 mm
BM-2752 37 x 98 mm
Yan bleyd (çift)
Lateral blades (pair)



BM-2750 - BM-2752



BM-2753 61 x 80 mm



BM-2753

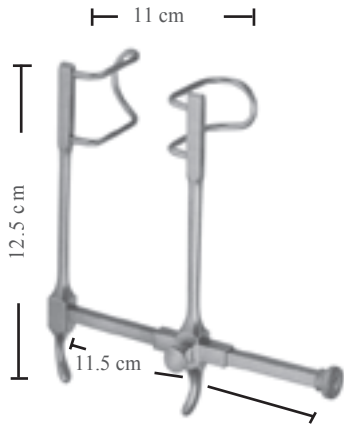

GOSSET
BM-2670
Bleyd/Blades 38 mm

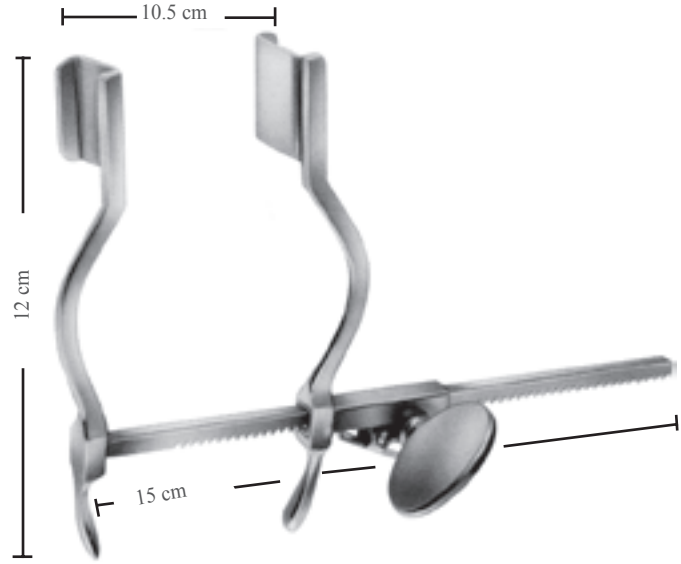

HERTZLER
BM-2675
Bleyd/Blades
20 x 25 mm

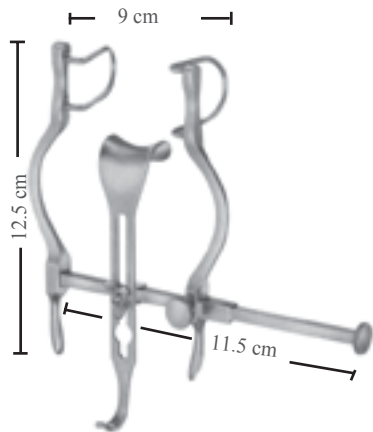

BALFOUR-BABY
BM-2680
Yan bleyd/Lateral blades 27 mm
Orta bleyd BM-2795
Center blade 21 x 24 mm

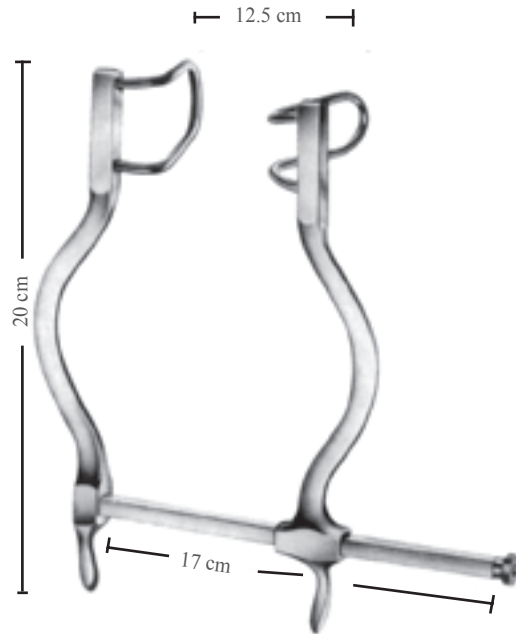

GOSSET
BM-2685
Bleyd/Blades 55 mm



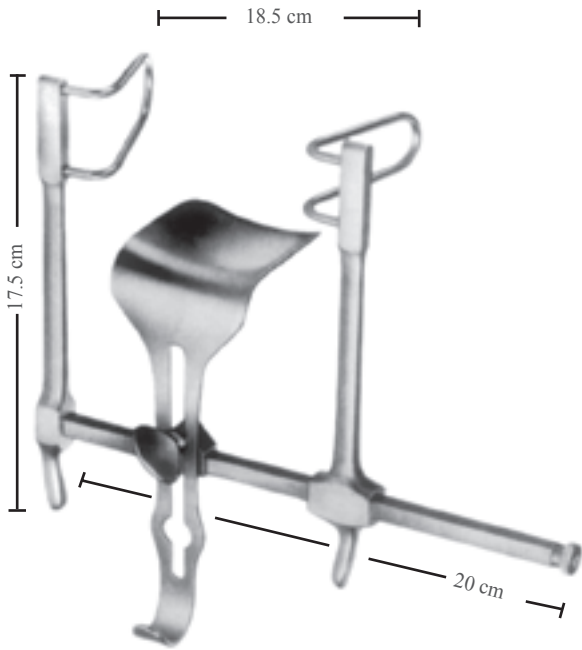

**GOSSET
BM-2690**
Yan bleyd/Lateral blades 58 mm
Orta bleyd BM-2788
Center blade 59 x 57 mm

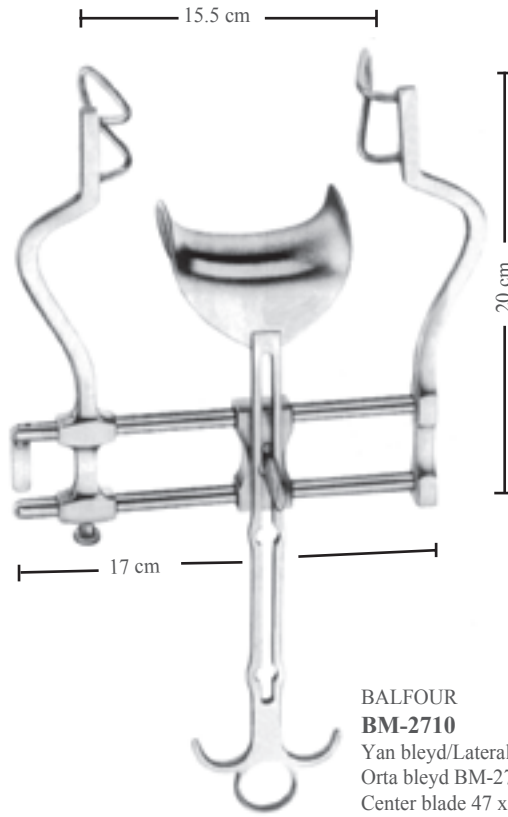

**BALFOUR
BM-2710**
Yan bleyd/Lateral blades 60 mm
Orta bleyd BM-2790
Center blade 47 x 80 m

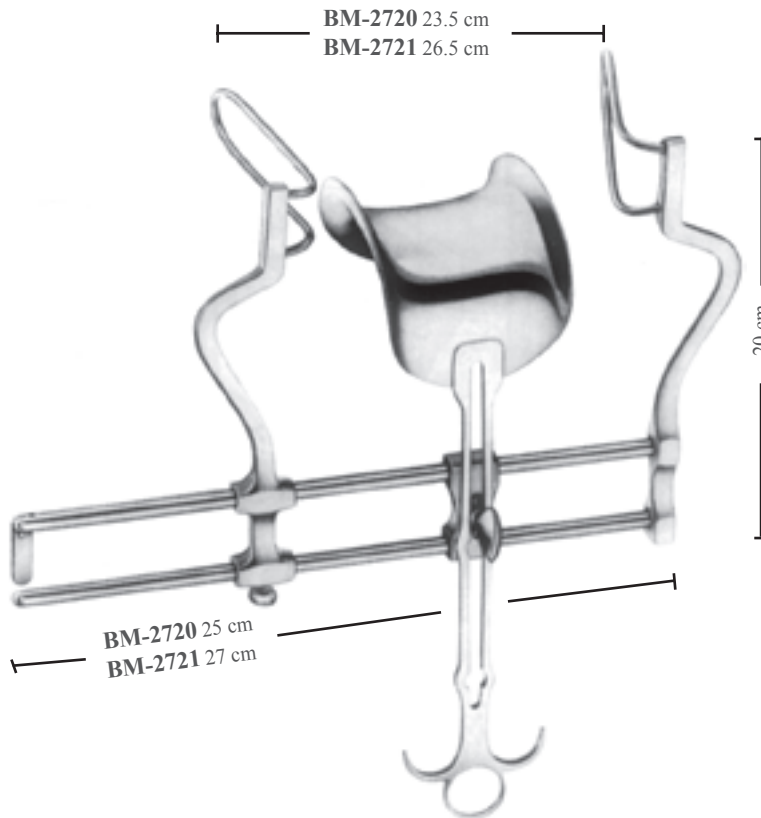

**BALFOUR
BM-2720 - BM-2721**

	BM-2720	BM-2721
Yan bleyd	60 mm	90 mm
Lateral blades		
Orta bleyd	BM-2791	BM-2792
Center blade	62 x 76 mm	80 x 80 mm

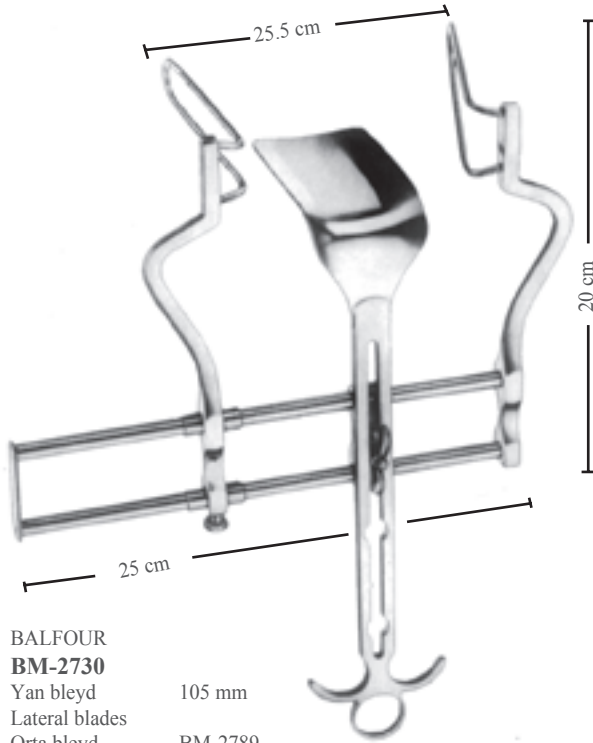

BALFOUR
BM-2730
Yan bleyd
Lateral blades 105 mm
Orta bleyd
Center blade BM-2789
107 x 59 mm



BM-2793
Orta bleyd
Center blade
54 x 80 mm



BM-2794
Orta bleyd, prostatektomi için kanallı 75 x 80 mm
Center blade, slotted for retropubie prostatectomy
75 x 80 mm

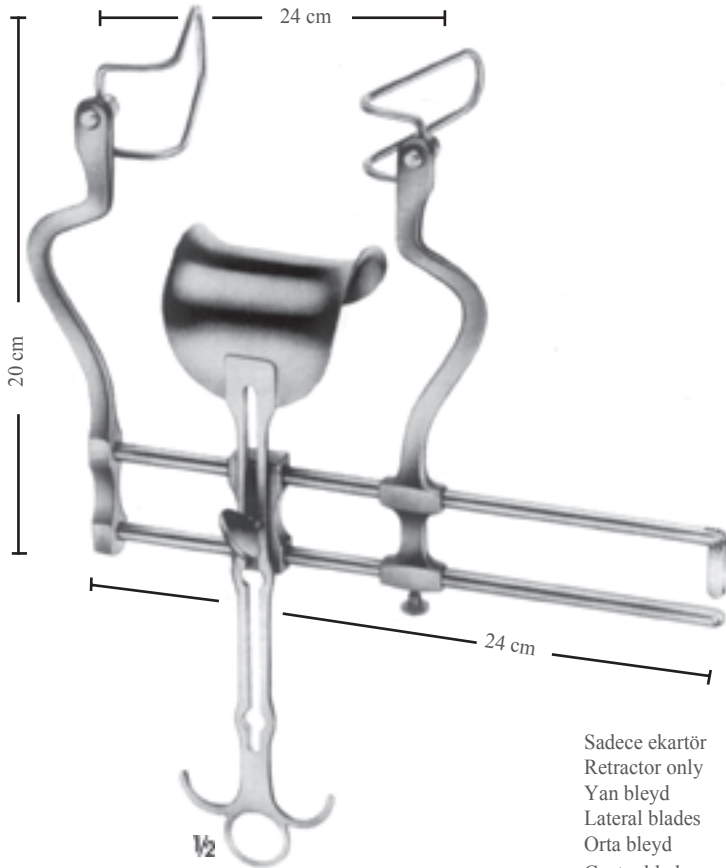

BALFOUR
BM-2735 - BM-2738
Komple/Complete

Sadece ekartör
Retractor only
Yan bleyd
Lateral blades
Orta bleyd
Center blade

	BM-2735	BM-2736	BM-2737	BM-2738
Retractor only	BM-2739	BM-2739	BM-2739	BM-2739
Lateral blades	BM-2758 50 mm	BM-2759 60 mm	BM-2760 75 mm	BM-2761 90 mm
Center blade	BM-2790 47 x 80 mm	BM-2791 62 x 76 mm	BM-2792 80 x 80 mm	BM-2792 80 x 80 mm



BM-2758 50 mm
BM-2759 60 mm
BM-2760 75 mm
BM-2761 90 mm
Yan Bleyd/Lateral Blades





GOLIGHER
BM-2700

Komple/Complete
Orta bleyd/Center blade 51 mm
Orta bleyd/Center blade 102 mm
Yan bleyd(bir çift)/Lateral blades (pair) 51 mm
Yan bleyd(bir çift)/Lateral blades (pair) 102 mm



BM-2831
Sadece ekartör
Retractor only

O'SULLIVAN-O' CONNOR
BM-2830 Komple/Complete
BM-2831
BM-2832 (2 adet)-BM-2833(1 adet)



O'SULLIVAN-O' CONNOER
BM-2832
Küçük bleyd/Small blade



O'SULLIVAN-O' CONNOER
BM-2833
Büyük bleyd/Large blade

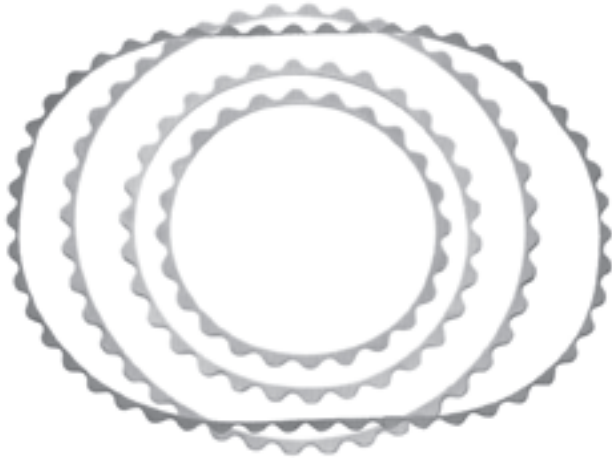

TURNER-WARWICK
BM-2841 Ø 18 cm
BM-2842 Ø 23 cm
BM-2843 Ø 30.5 cm
Ekartör çemberi, yuvarlak
Retractor frame, round
BM-2844
Ekartör çemberi, oval
Retractor frame, oval
457 x 330 mm



TURNER-WARWICK
BM-2840 Komple/Complete
BM-2841 1 adet/1 each
BM-2843 1 adet/1 each
BM-2850 2 adet/2 each
BM-2853 2 adet/2 each
BM-2846 2 adet/2 each
BM-2847 2 adet/2 each
BM-2848 2 adet/2 each
BM-2849 2 adet/2 each
BM-2845 2 adet/2 each

BM-2845
13 mm



BM-2846
51 x 38 mm



BM-2847
76 x 60 mm



BM-2848
89 x 60 mm



BM-2849
114 x 60 mm



BM-2850
Bükülebilir/Malleable
76 x 19 mm



BM-2851
Bükülebilir/Malleable
102 x 38 mm



BM-2852
Bükülebilir/Malleable
89 x 57 mm



BM-2853
Bükülebilir/Malleable
114 x 57 mm



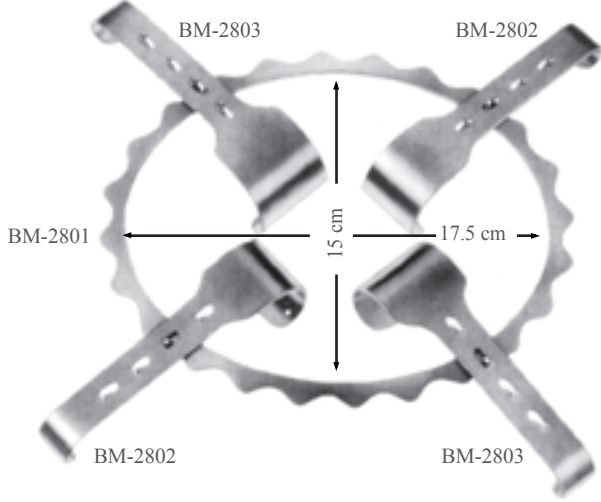

DENNIS-BROWNE

BM-2800

Komple/Complete

BM-2801	175 x 150 mm	Çember/Frame
BM-2802	40 x 30 mm	2 adet bleyd/2 each blades
BM-2803	40 x 40 mm	2 adet bleyd/2 each blades



BM-2804

1 adet bleyd
1 each blade
20 x 30 mm

BM-2805

1 adet bleyd
1 each blade
20 x 40 mm

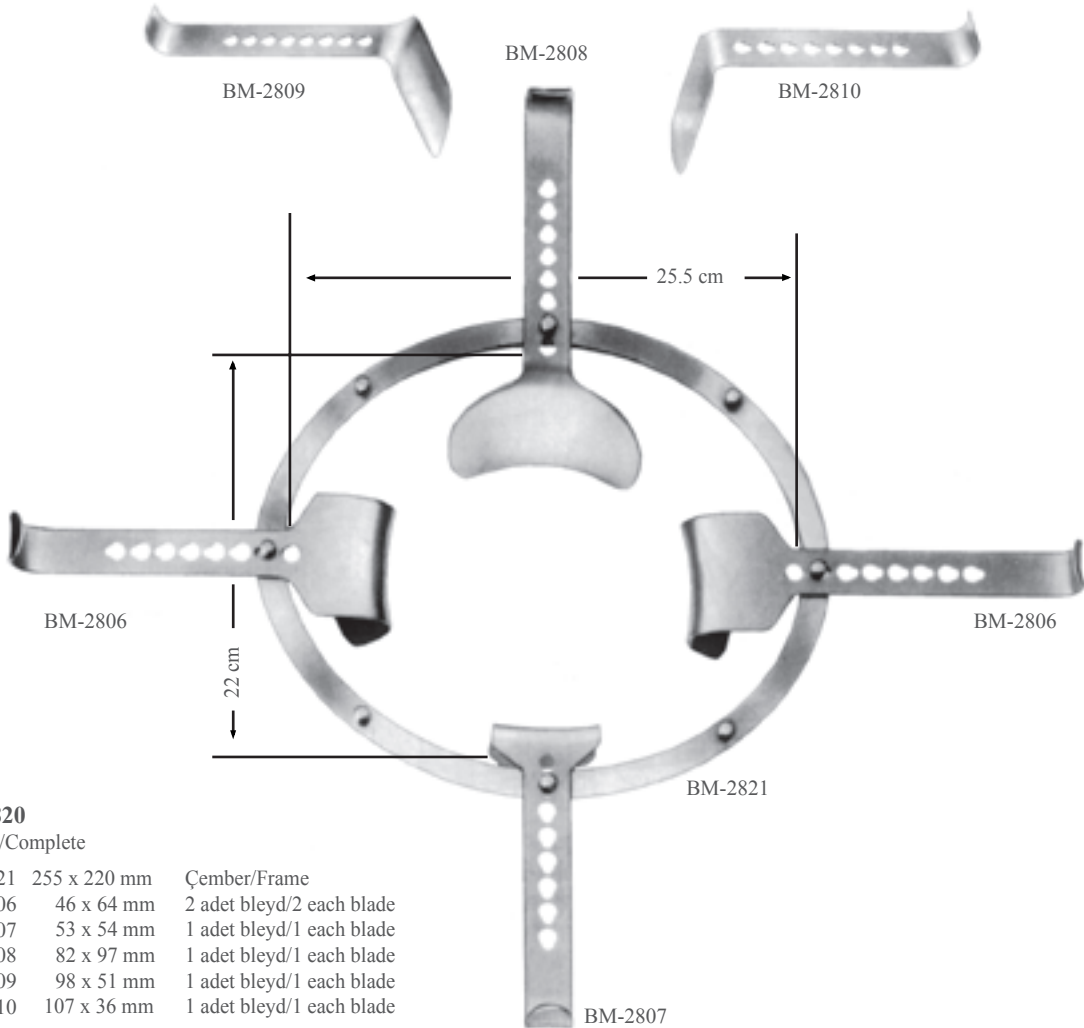

SEMM

BM-2820

Komple/Complete

BM-2821	255 x 220 mm	Çember/Frame
BM-2806	46 x 64 mm	2 adet bleyd/2 each blade
BM-2807	53 x 54 mm	1 adet bleyd/1 each blade
BM-2808	82 x 97 mm	1 adet bleyd/1 each blade
BM-2809	98 x 51 mm	1 adet bleyd/1 each blade
BM-2810	107 x 36 mm	1 adet bleyd/1 each blade



KIRSCHNER
BM-2868
64 x 80 mm



KIRSCHNER-BALFOUR
BM-2869
80 x 82 mm



KIRSCHNER
BM-2870 90 x 69 mm
BM-2871 95 x 95 mm
BM-2872 78 x 58 mm



KIRSCHNER
BM-2873 108 x 42 mm
BM-2874 91 x 55 mm
BM-2875 120 x 55 mm

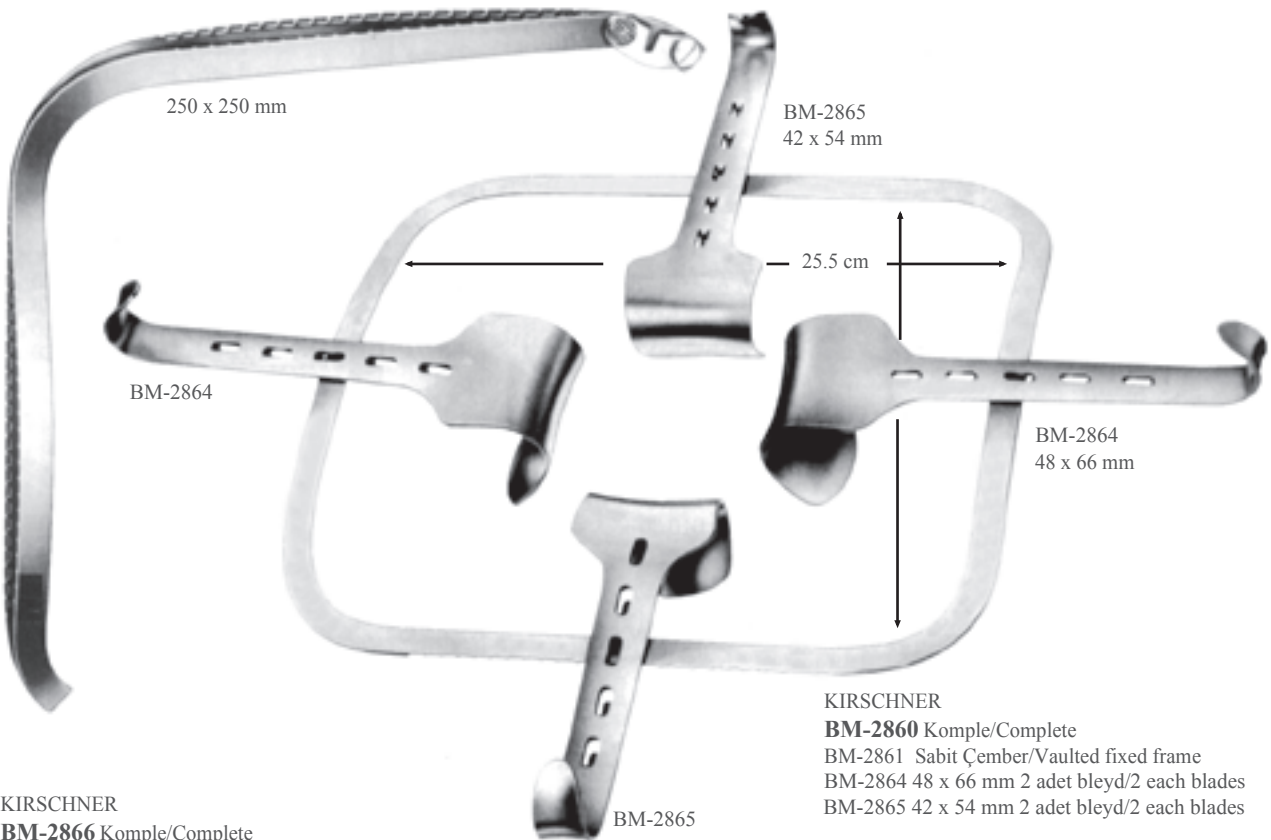

KIRSCHNER
BM-2866 Komple/Complete
BM-2867 Katlanabilir/Holding frame
BM-2864 48 x 66 mm 2 adet bleyd/2 each blades
BM-2865 42 x 54 mm 2 adet bleyd/2 each blades

KIRSCHNER
BM-2860 Komple/Complete
BM-2861 Sabit Çember/Vaulted fixed frame
BM-2864 48 x 66 mm 2 adet bleyd/2 each blades
BM-2865 42 x 54 mm 2 adet bleyd/2 each blades

BM-2862 275 x 355 mm
Büyük ölçekli çember
Frame only, over-sized

BM-2863 295 x 275 mm
Sadece Çember/Frame only





BM-1873
60 x 50 mm



BM-1872
40 x 35 mm



BM-2653
57 x 25 mm



BM-1870 Komple/Complete
Popliteal Ekartör/Popliteal Retractor
BM-1871 Sadece ekartör/Retractor only
BM-1873 Bleyd çift, künt 60 x 50 mm
Blades pair blunt 60 x 50 mm
Bleyd çift, yarı sivri, 40 x 35 mm
Blades pair semi-sharp 40 x 35 mm



MILLIN
BM-2650 Komple/Complete
Mesane Ekartörü/Bladder Retractor
BM-2652 Sadece ekartör/Retractor only
BM-2653 Bleyd 57 x 25 mm/Blades 57 x 25 mm
BM-2654 Bleyd 82 x 25 mm/Blades 82 x 25 mm
BM-2655 Orta bleyd 105 x 45 mm
Center blade 105 x 45 mm

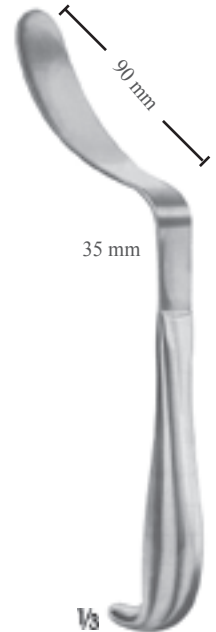

LEGUEU
BK-8735
Mesane spatulası
Bladder spatula
26 cm



ALLENBERG
BM-9861
Sadece ekartör
Retractor only

ALLENBERG
BM-9860
İliak ekartörü komple
Iliaca retractor complete
BM-9861 Sadece ekartör/Retractor only
BM-9862 Yan Bleyd/Lateral Blade 30 x 30 mm
BM-9863 Orta Bleyd/Medial Blade 90 x 60 mm



ALLENBERG
BM-9862
Yan Bleyd/Lateral Blade
Titanyum/Titanium
30 x 30 mm



ALLENBERG
BM-9863
Orta Bleyd/Medial Blade
Titanyum/Titanium
90 x 60 mm



ALLENBERG
BD-8090
Bleyd değiřtirmek için penset
Forceps for changing the blades
13 cm

Arteria İliak communis'e optimum yaklaşım için ekartör.

Bleydleri titanyumdan yapılmıştır ve bu sebeple x ışını geçirgendir. Büyük ekartör bleydi operasyon esnasında kademeli olarak ayarlanabilir. Ekartör bleydlerin kolaylıkla değiřtirilebiliyor olması ekartör sisteminin sağ taraftan ve sol taraftan kullanımını sağlar.

Retractor system for optimal approach to the arteria iliaca communis.

The retractor blades are made out of titanium and therefore they are radiotransparent. The big medial retractor blade can be gradually adjusted during the operation. Because of the blades which are easy to exchange the retractor system can be used for the left and the right side.



*Çok Amaçlı Çember Ekartör Sistemi için web sitemizi ziyaret ediniz.
Please visit our website for **Multi-Purpose Ring Retractor System**.*

www.aseltech.com.tr



*hayatın kalbine...
to heart of life...*



*Universal Ekartör Sistemleri için web sitemizi ziyaret ediniz.
Please visit our website for **Universal Retractor System**.*

www.aseltech.com.tr



*hayatın kalbine...
to heart of life...*



GS

Genel Cerrahi
General Surgery





ALLEN
BG-2400
15.5 cm

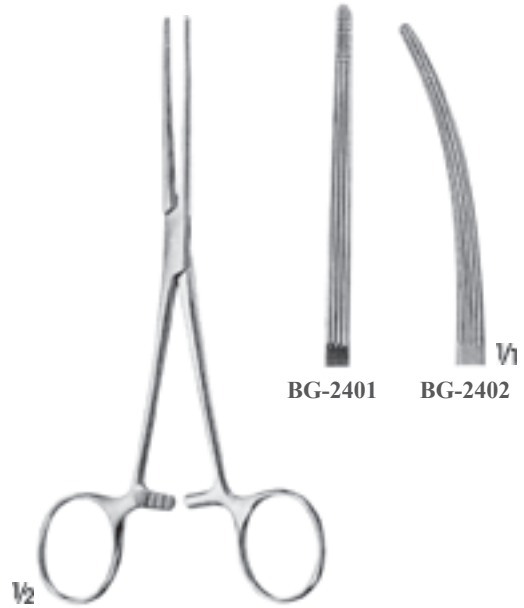

BAINBRIDGE
BG-2401 - BG-2402
15.5 cm

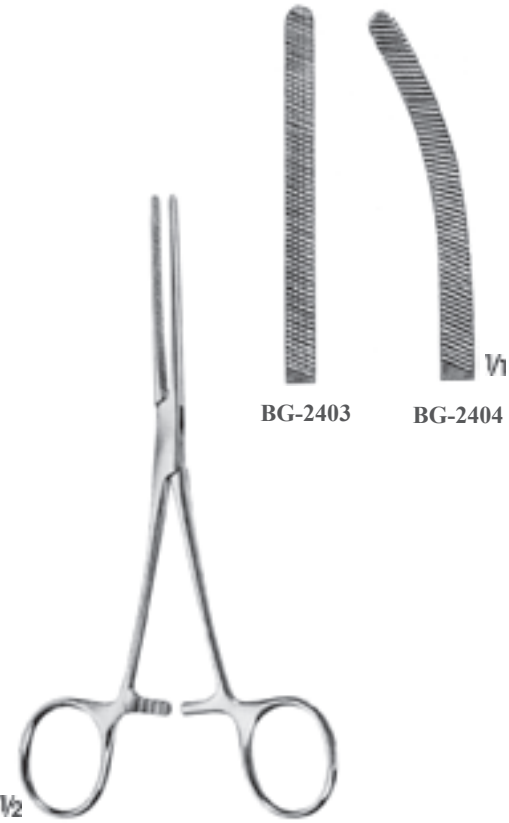

DOYEN
BG-2403 - BG-2404
Elastik/Elastic
16.5 cm

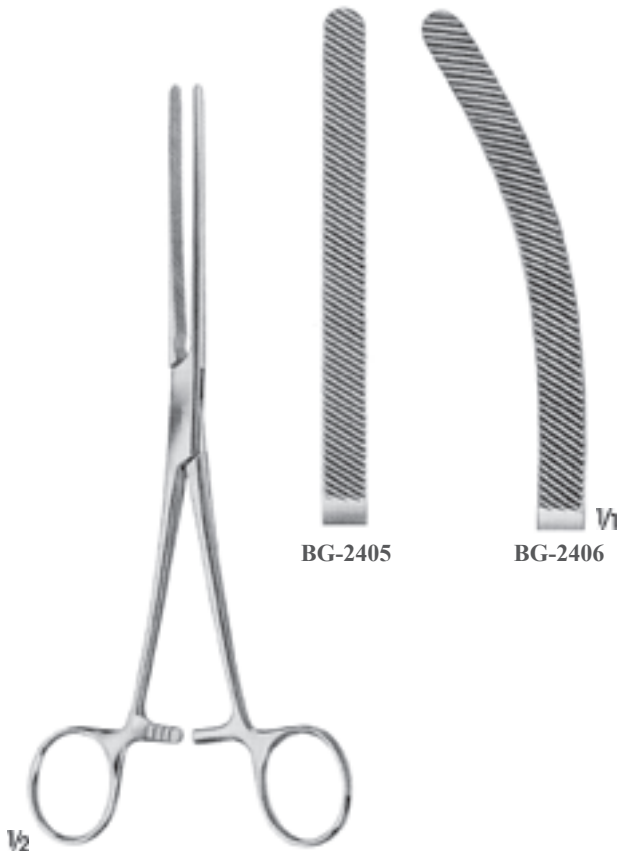

HARTMANN
BG-2405 - BG-2406
Yumuşak ve elastik
Soft and elastic
20 cm



BABY-KOCHER
BG-2407 - BG-2408
Çocuklar için/For children
Çok elastik/Very elastic
13 cm

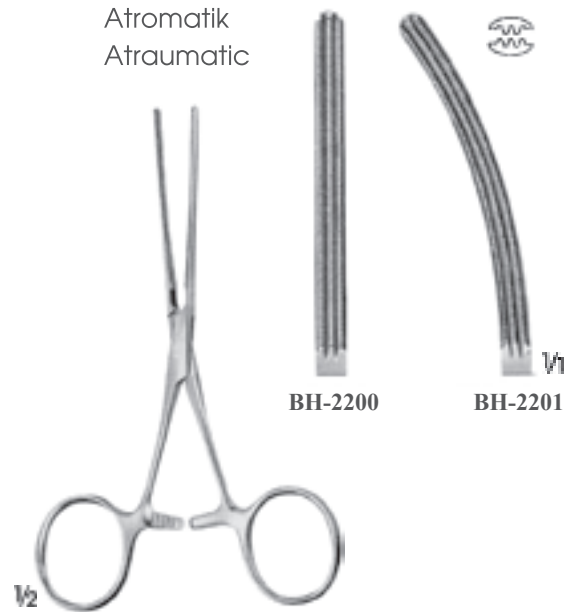

Atromatik
Atraumatic
BABY-KOCHER
BH-2200 - BH-2201
Çocuklar için/For children
Yumuşak ve elastik/ Soft and elastic
13 cm

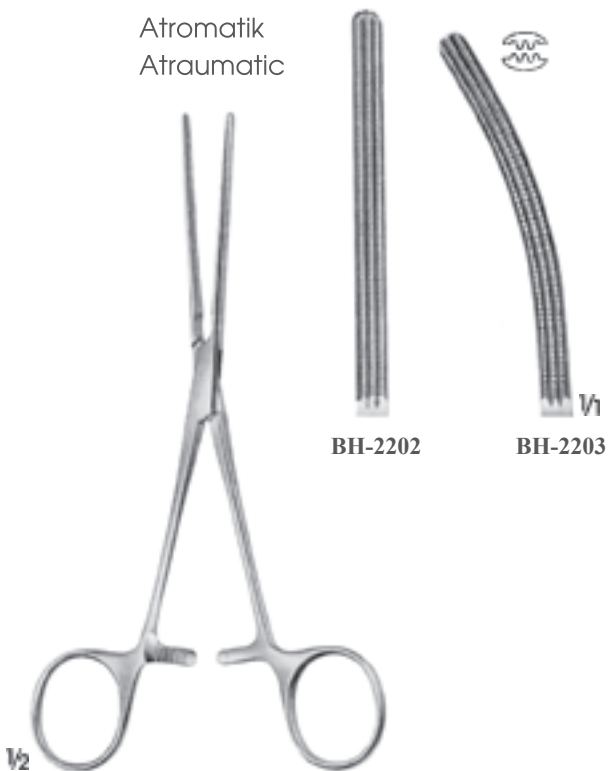

Atromatik
Atraumatic
DOYEN
BH-2202 - BH-2203
Yumuşak ve elastik
Soft and elastic
17 cm

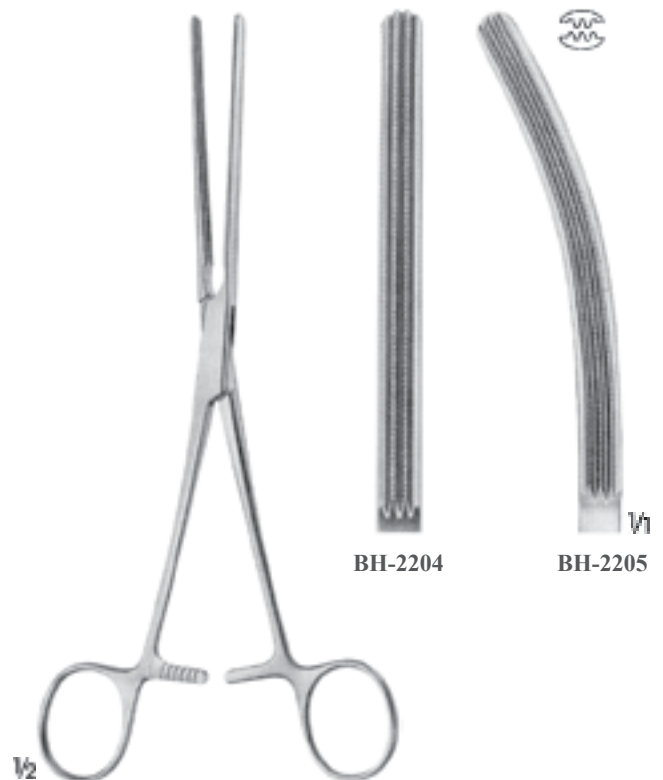

Atromatik
Atraumatic
HARTMANN
BH-2204 - BH-2205
Yumuşak ve elastik
Soft and elastic
20 cm





BG-2410
21 cm

BG-2411
23 cm

BG-2412
21 cm

BG-2413
23 cm

BG-2414

BG-2415

KOCHER
BG-2410 - BG-2411
BG-2412 - BG-2413
Yumuşak ve elastik
Soft and elastic

DOYEN
BG-2414 - BG-2415
Yumuşak ve elastik
Soft and elastic
24 cm

Atromatik
Atraumatic



BH-2212

BH-2213

DOYEN
BH-2212 - BH-2213
Yumuşak ve elastik
Soft and elastic
23 cm

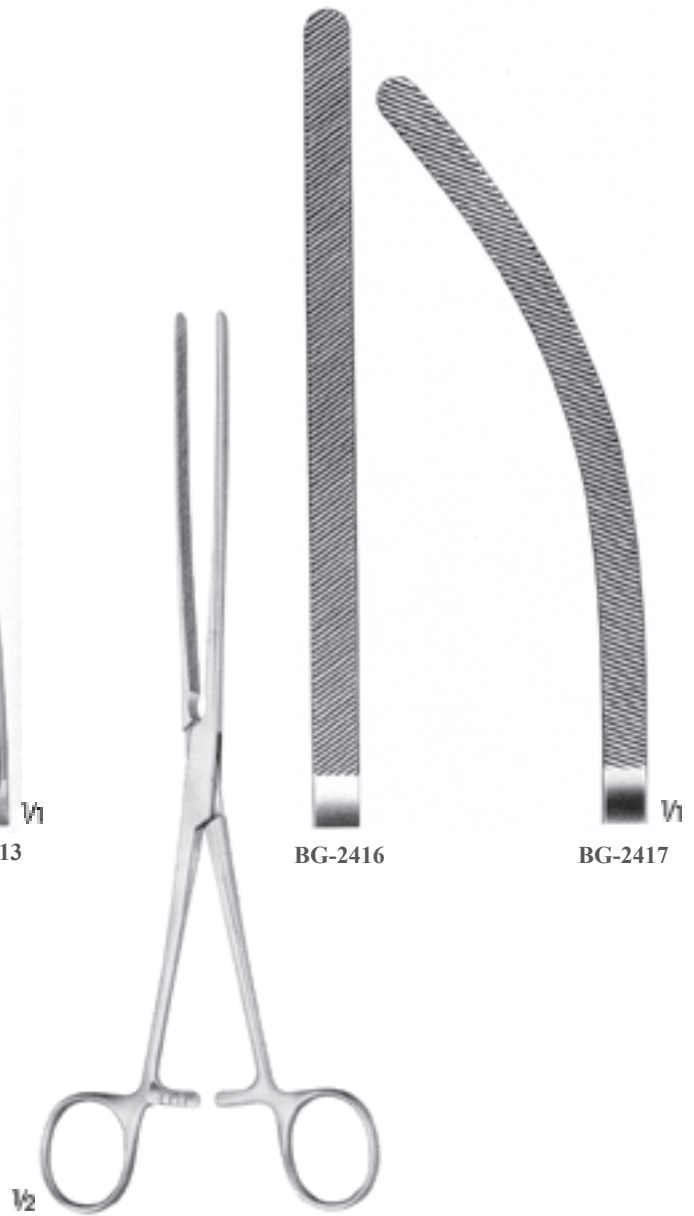

BG-2416

BG-2417

DOYEN
BG-2416 - BG-2417
Yumuşak ve elastik
Soft and elastic
23.5 cm



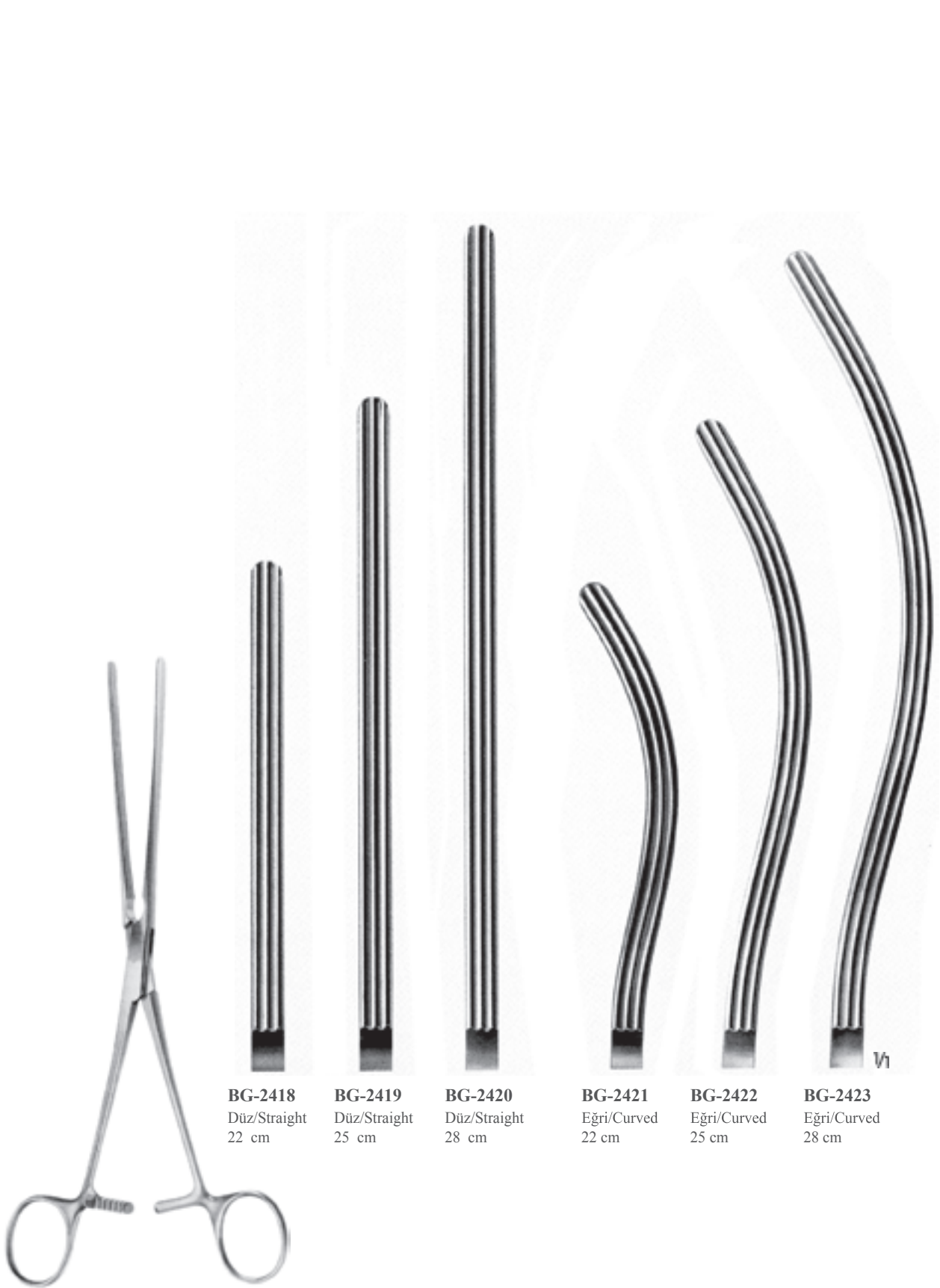

KOCHER
BG-2418 - BG-2420
BG-2421 - BG-2423
Yumuşak ve elastik
Soft and elastic

BG-2418
Düz/Straight
22 cm

BG-2419
Düz/Straight
25 cm

BG-2420
Düz/Straight
28 cm

BG-2421
Eğri/Curved
22 cm

BG-2422
Eğri/Curved
25 cm

BG-2423
Eğri/Curved
28 cm



KOCHER
BH-2206 - BH-2208
BH-2209 - BH-2211
Yumuşak ve elastik
Soft and elastic

BH-2206
Düz/Straight
22 cm

BH-2207
Düz/Straight
25 cm

BH-2208
Düz/Straight
28 cm

BH-2209
Eğri/Curved
22 cm

BH-2210
Eğri/Curved
25 cm

BH-2211
Eğri/Curved
28 cm



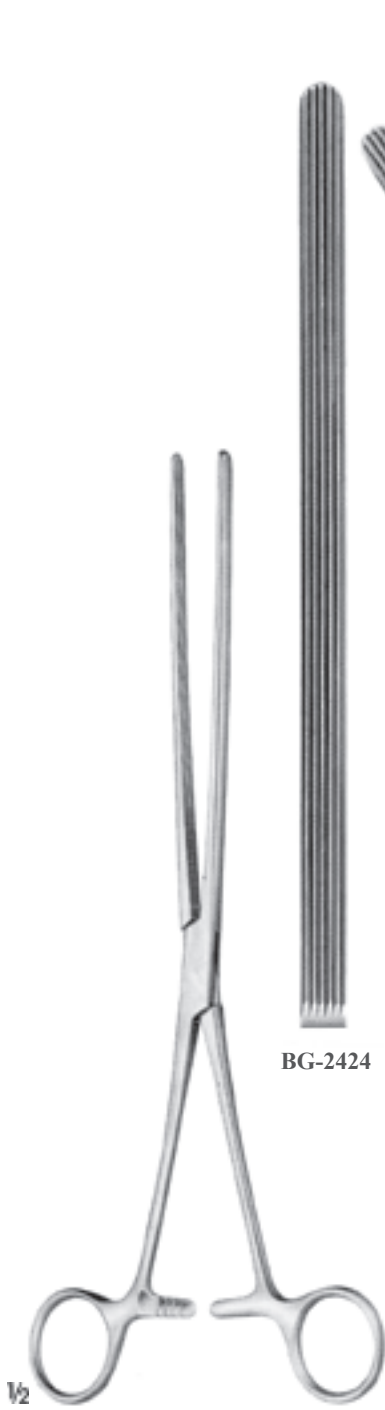

BG-2424

MAYO-ROBSON
BG-2424 - BG-2425
Sert ve elastik
Hard and elastic
25 cm



BG-2425

V2

Atromatik
Atraumatic



BH-2217

MAYO-ROBSON
BH-2217 - BH-2218
25 cm



BH-2218

V1



NUSSBAUM
BG-2426 - BG-2427
Yumuşak ve elastik
Soft and elastic
25 cm



BG-2427

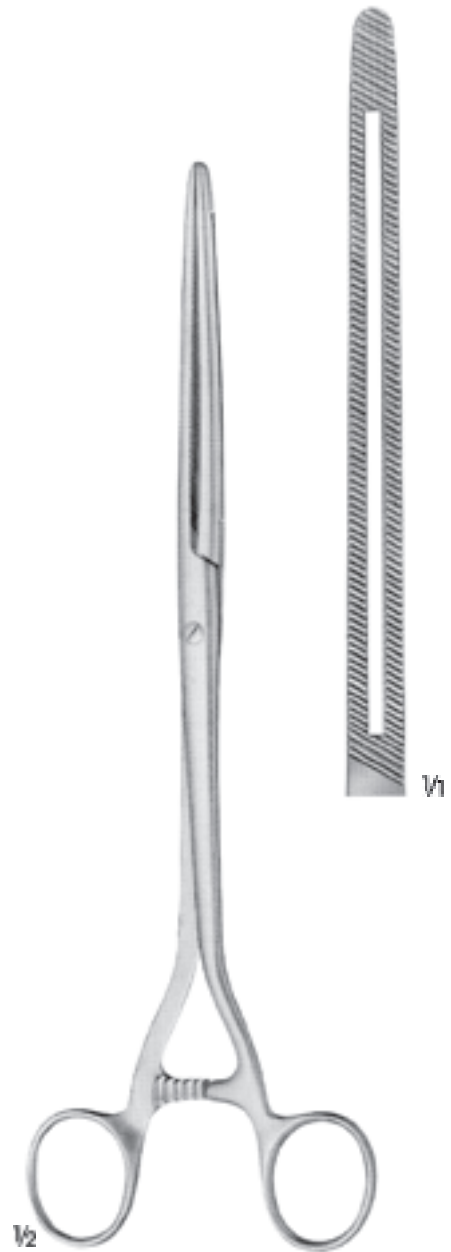

MAYNIHAN
BG-2430
28 cm





SCHOEMAKER
BG-2428
Kolektomi klempi
Colectomy clamp
20 cm



LANG-STEVENSON
BG-2429
Bağırsak klempi
Intestinal clamp
20 cm



SCUDDER
BH-2219
Mide klempi
Stomach clamp
33 cm

Atomatik
Atraumatic





PAYR
BG-4118
Çocuklar için bağırsak klemp
Intestinal clamp light pattern,
for children
18 cm

PAYR
BG-4120
20 cm

PAYR
BG-4127
27.5 cm

PAYR
BG-4131
Pilor Klemp
Pylorus clamp
31.5 cm



LANE
BG-4014
31 cm



LANE
BG-4015
31 cm



HABERER
BG-4016
36 cm





BENSON
BG-2432
Pilor ayırıcı
Pylorus spreader
15.5 cm



KLEINSCHMIDT
BG-2409
Apendektomi klempl
Appendectomy clamp
13 cm



DE MARTEL-WOLFSON
BG-4200 10 cm
BG-4201 12 cm
Anastomoz klempl, 3'lü set
Anastomosis clamps,
set of 3



Sert Klempl tutucu
Clamp holder with set of clamps

BG-4203 22.5 cm
Klempl tutucusu
Clamp holder
(BG-4200 - BG-4201)

BG-4202 8 cm
Klempl tutucusu
Clamp holder
(BG-4200 - BG-4201)



DE MARTEL-WOLFSON
BG-4204
Kapama pensu
Closing forceps
(BG-4200 - BG-4201)
25 cm



Atomatik
Atraumatic

DICK
BH-2078 25.5 cm
BH-2088 26.5 cm
BH-2098 27.5 cm
Güçlü klemler
Pressure clamps



BH-2078
78 mm

BH-2088
88 mm

BH-2098
98 mm

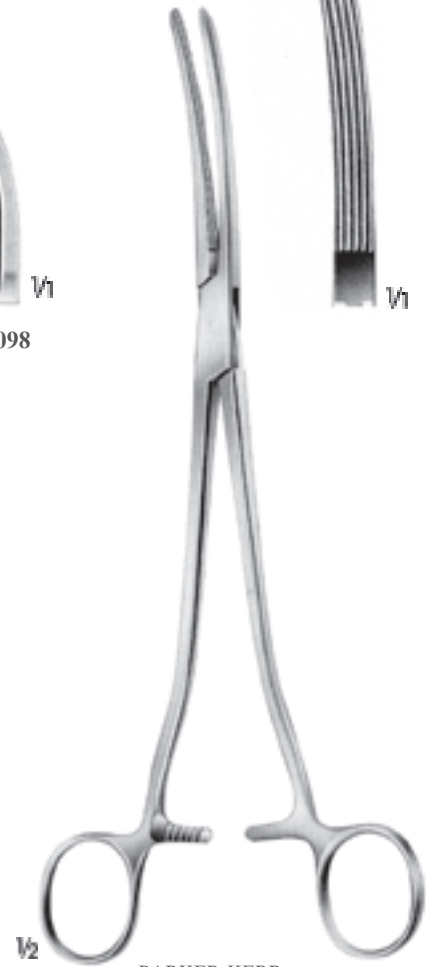

PARKER-KERR
BG-4001
Anastomoz pensu, kolon
rezeksiyonu için
Anastomosis forceps for
colon resection
25 cm



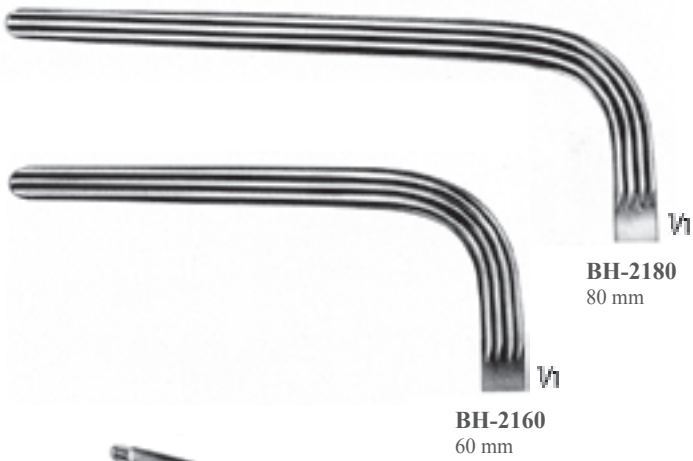

BH-2160
60 mm

BH-2180
80 mm



BH-2160 - BH-2180
23 cm

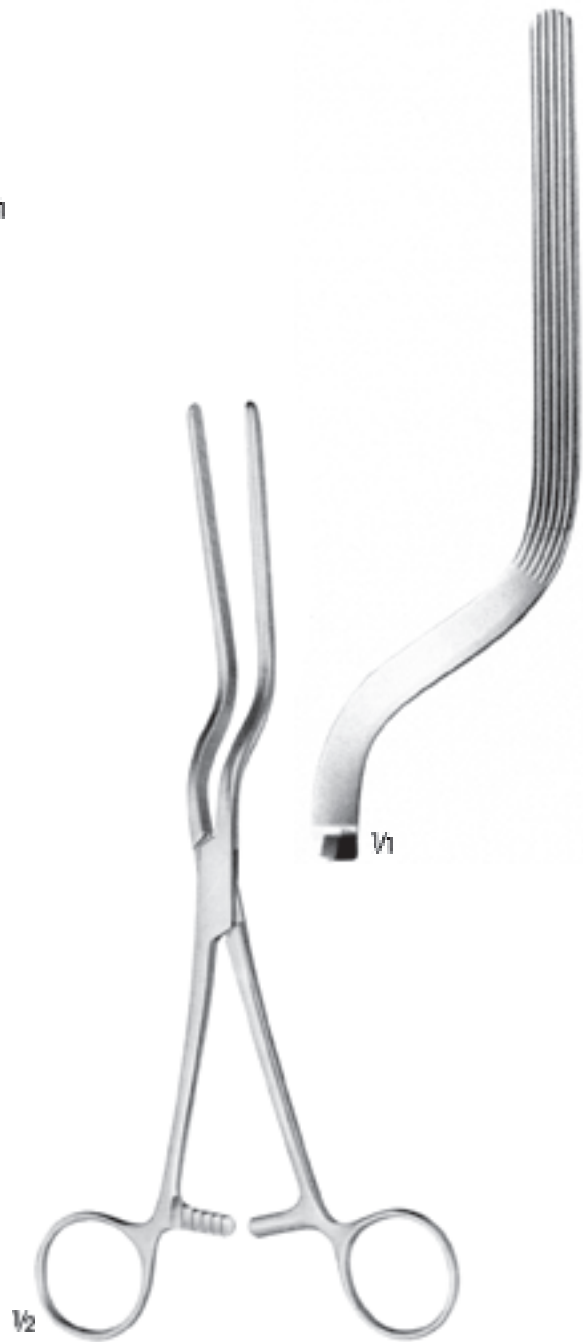

BRUNNER
BG-2431
24.5 cm



V₂

V₂

LLOYD-DAVIS
BG-4018
31.5 cm



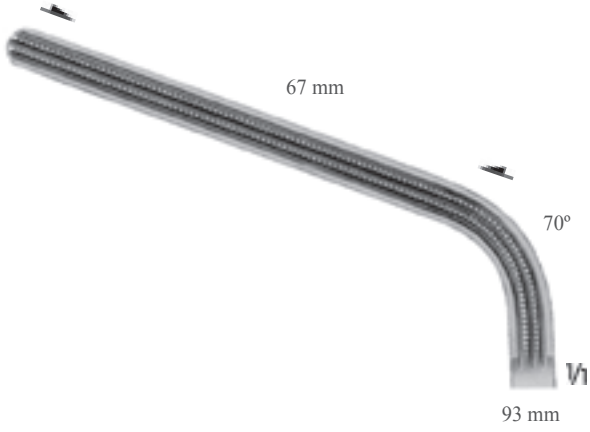

MORRIS
BH-3323
17.5 cm

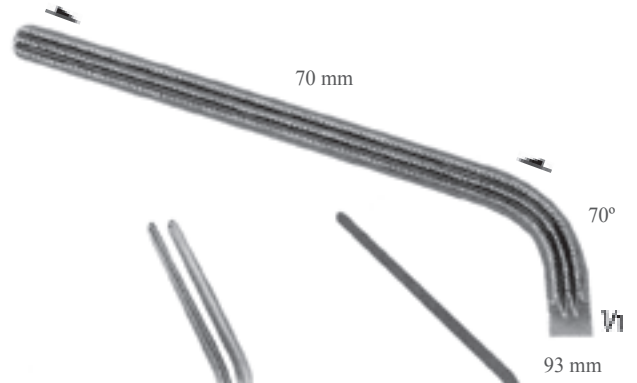

DE BAKEY (MORRIS)
BH-3325
24 cm

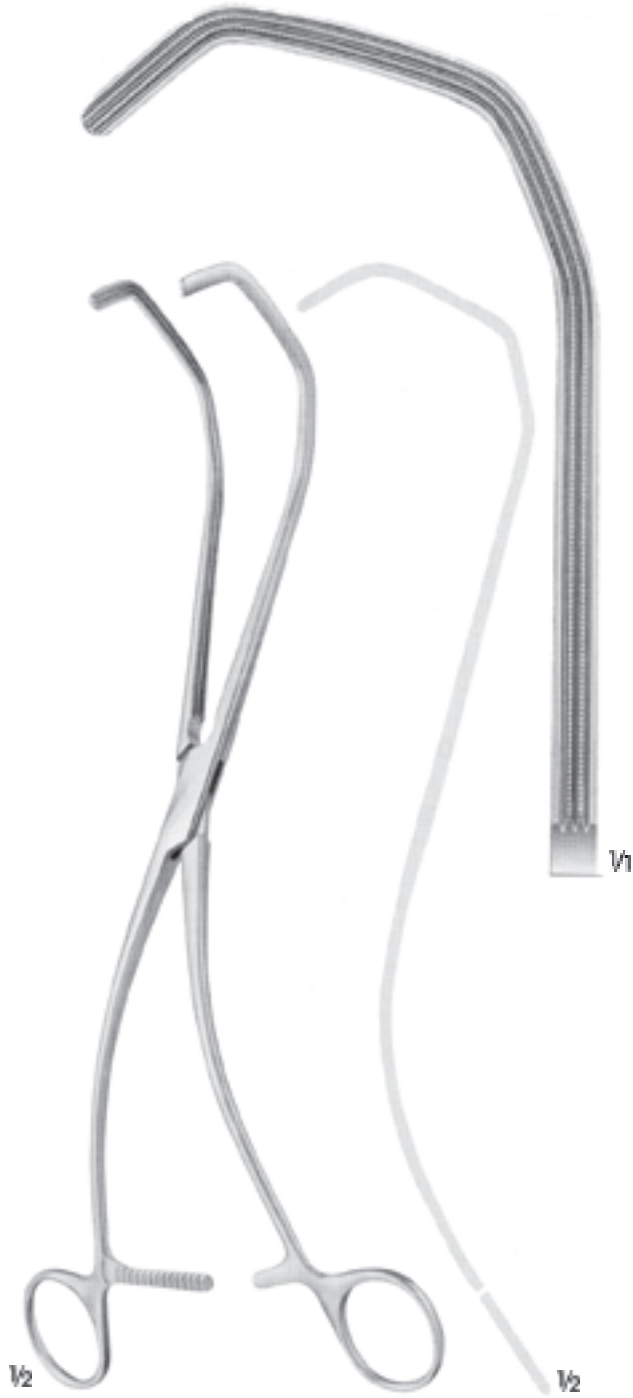

KERSTING
BH-2214
30 cm



RESONE
BH-2215
Yumuşak ve elastik/soft and elastic
26.5 cm



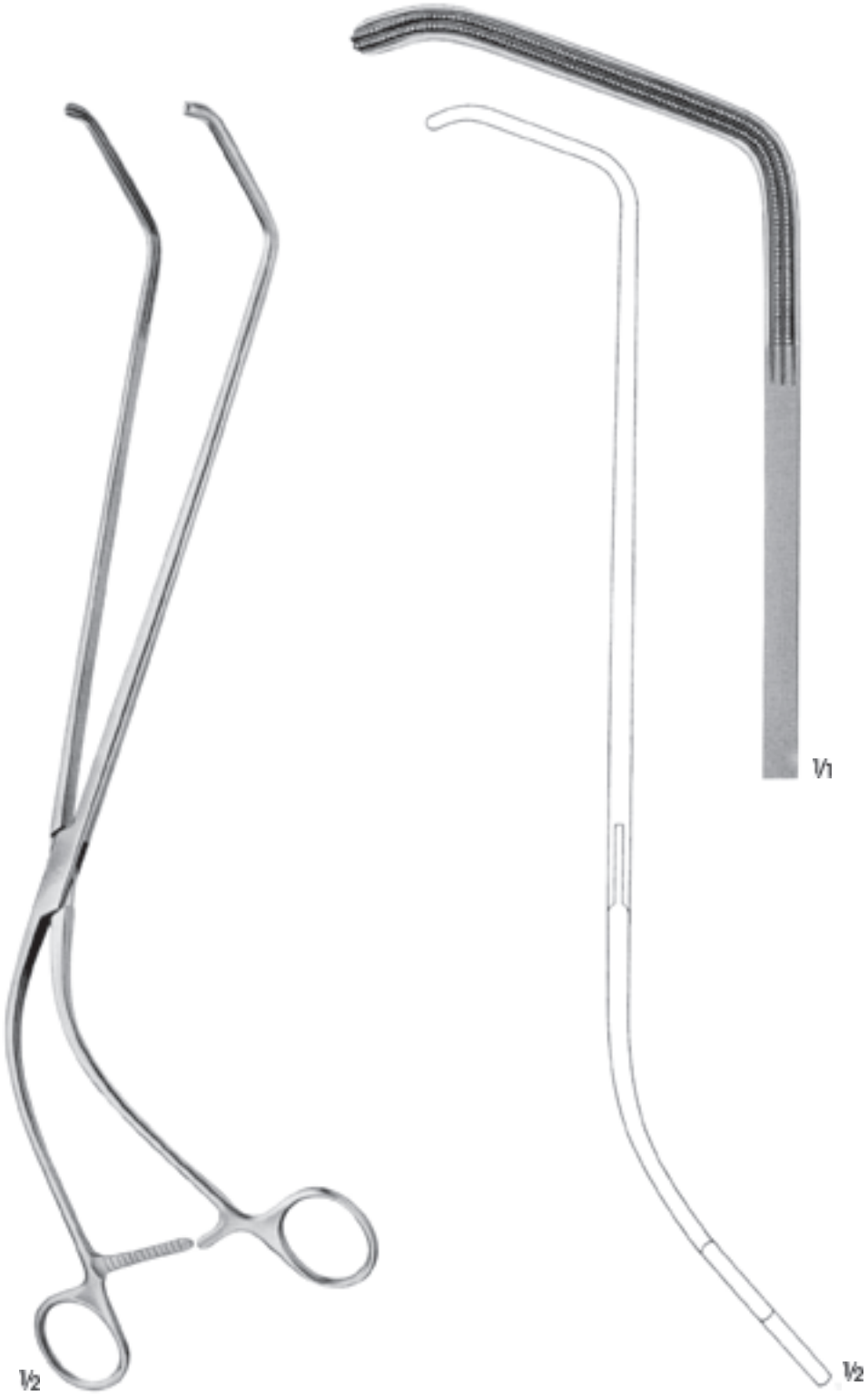

MULLER
BH-2216
Rektal anastomoz klemp
Rectal anastomosis clamp
37.5 cm

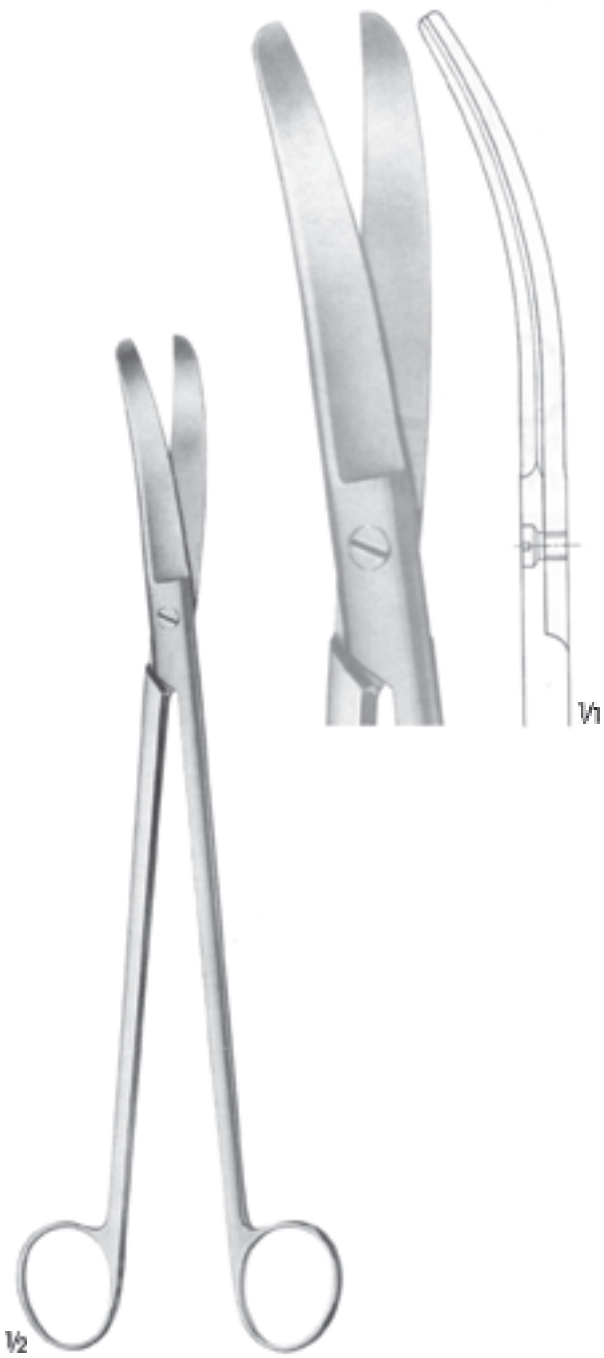

LLOYD-DAVIES (GOLIGHER'S)
BC-5400
27 cm

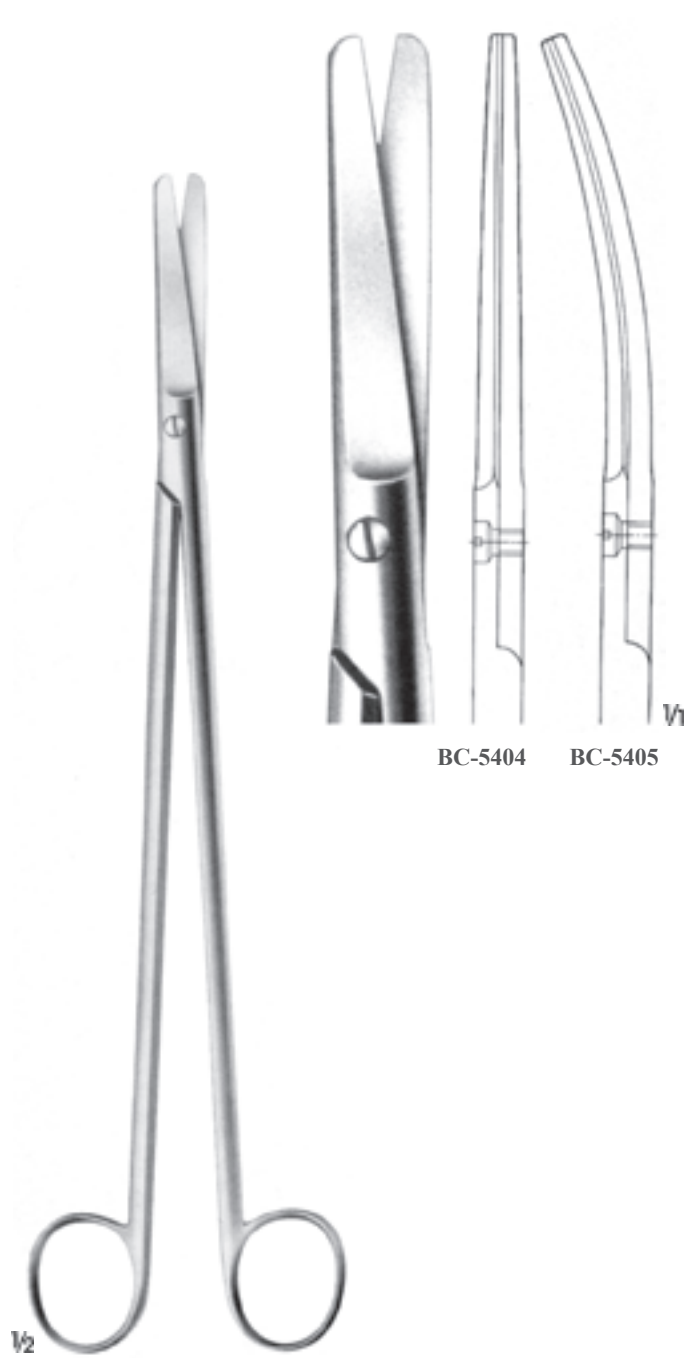

STELZNER
BC-5404 - BC-5405
31 cm



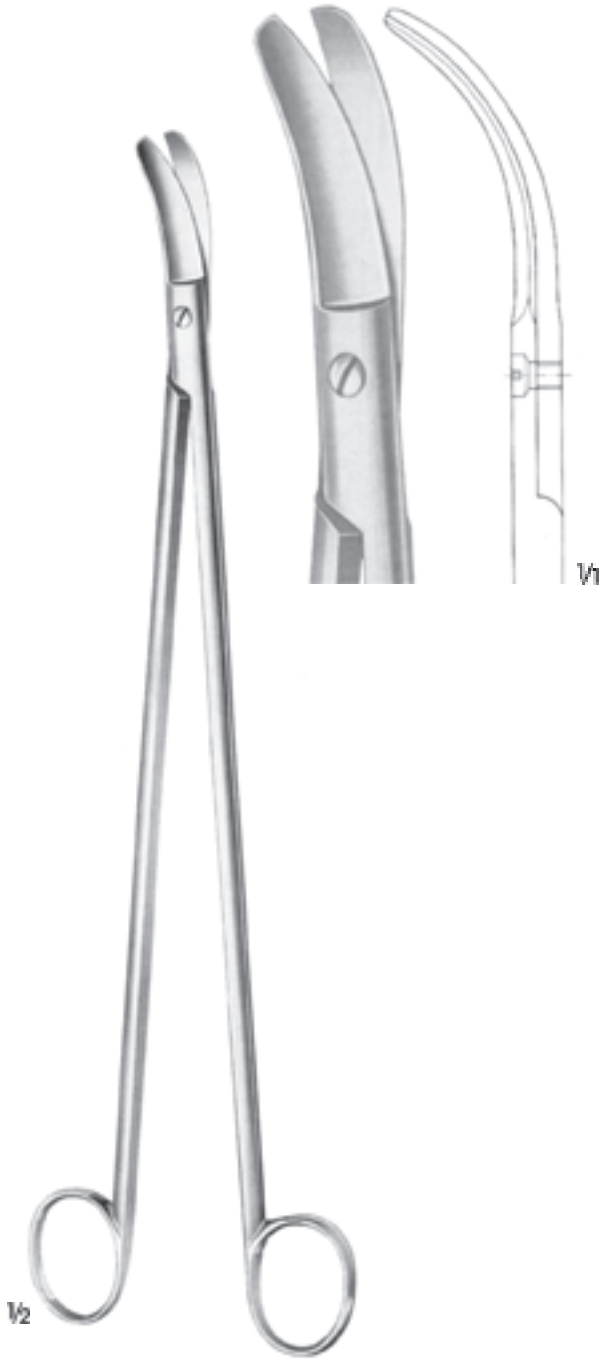

BC-5407
Rektal makas
Rectal scissors
32.5 cm

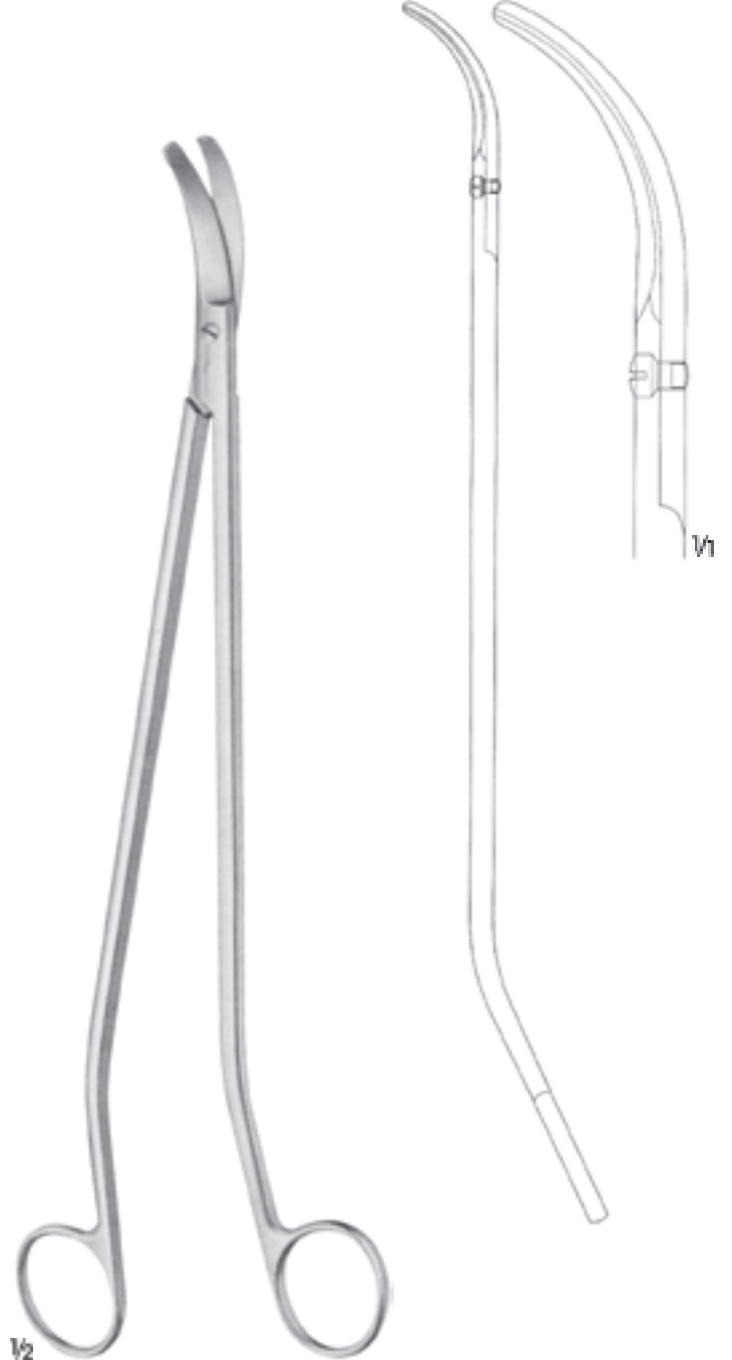

MÜLLER
BC-5406
Rektum makas s şekli
Rectum scissors s-shaped
32.5 cm



ALLIS
BE-2755
Tutma pensi
Grasping forceps
29.5 cm

Atromatik
Atraumatic



DE BAKEY
BD-4435
35 cm

HARDMODEL



MÜLLER
BF-5316
Portegü/Needle holder
36 cm



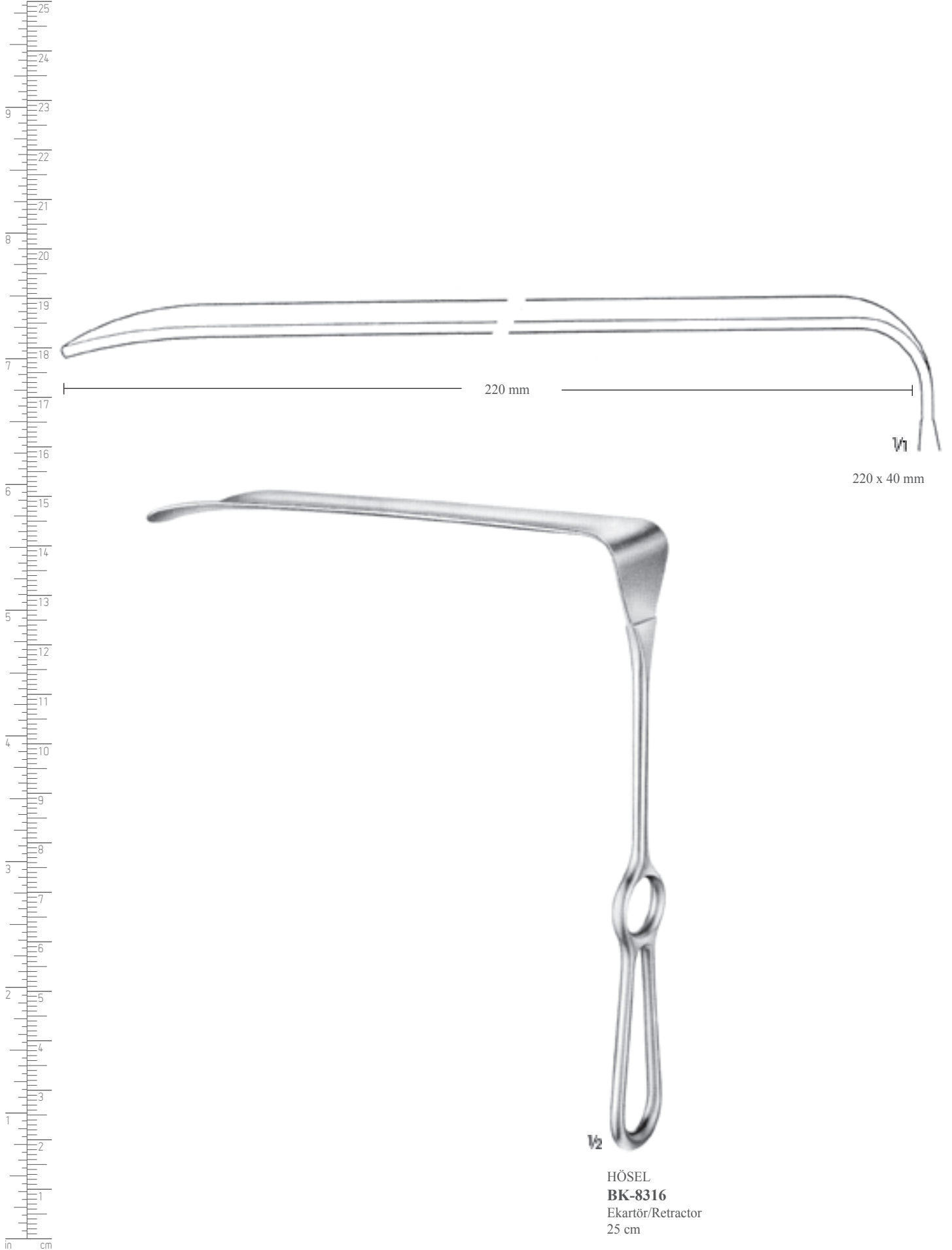

HÖSEL
BK-8316
Ekartör/Retractor
25 cm

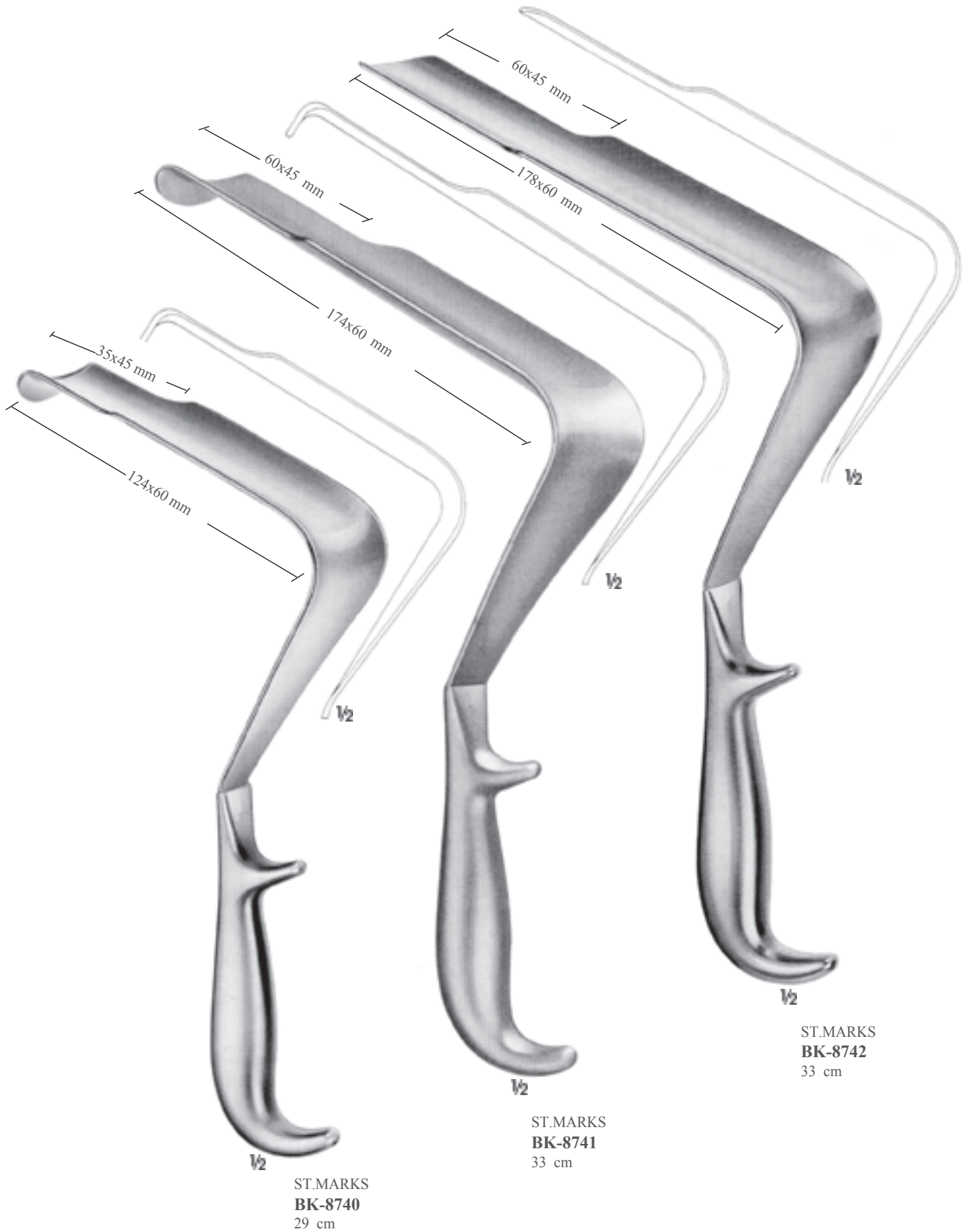



**CZERNY
BM-3900**
22.5 cm

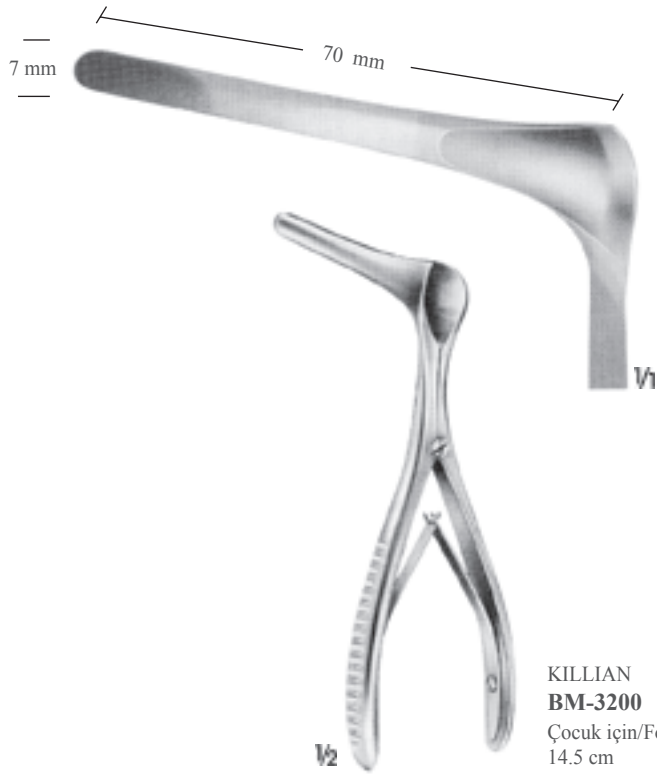

**KILLIAN
BM-3200**
Çocuk için/For children
14.5 cm

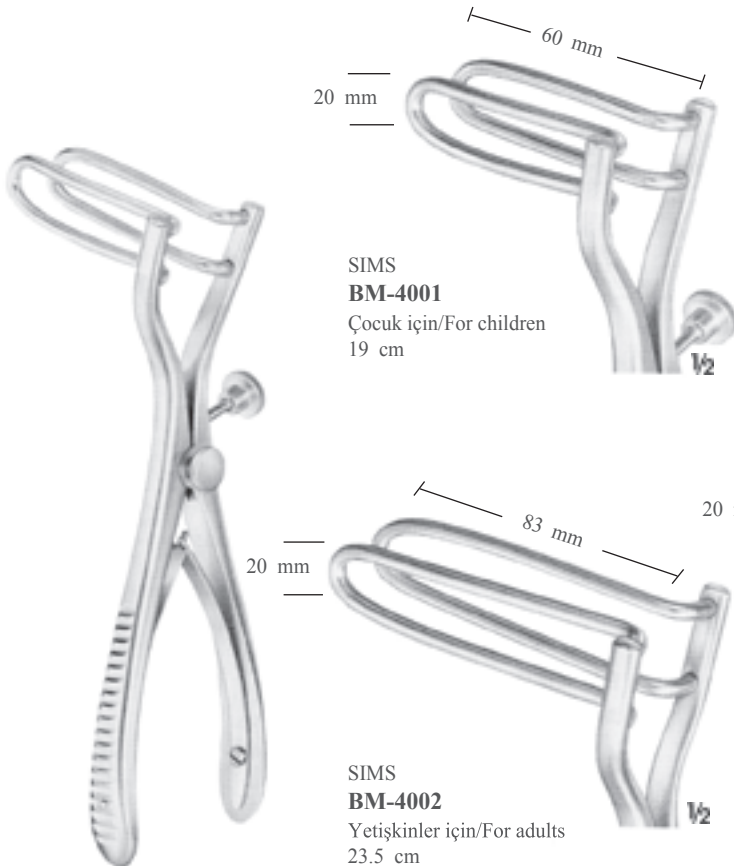

**SIMS
BM-4001**
Çocuk için/For children
19 cm

**SIMS
BM-4002**
Yetişkinler için/For adults
23.5 cm

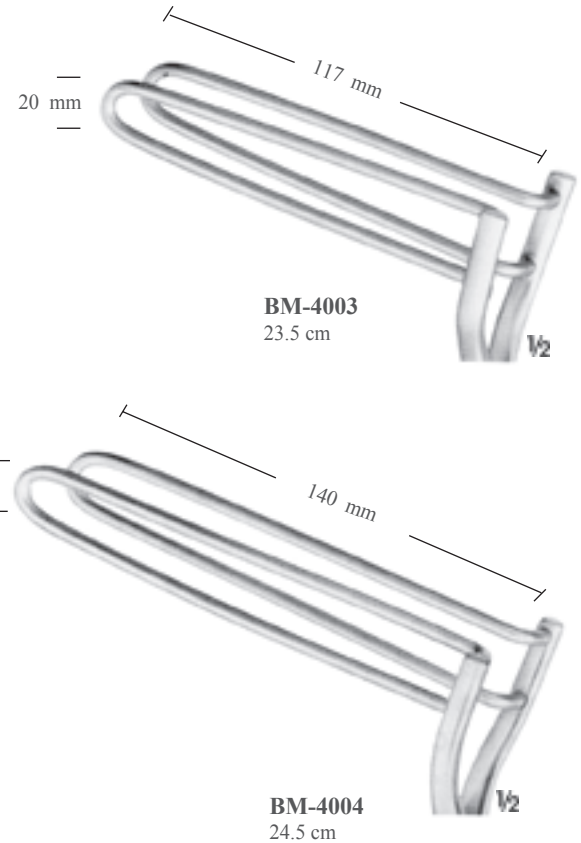

BM-4003
23.5 cm

BM-4004
24.5 cm



**SIMS
BM-4100**
16 cm



**SIMS
BM-4200**
16 cm



**PRATT
BM-4300**
20.5 cm



**MATHIEU
BM-4400**
21.5 cm





SIMS
BM-4500
15 cm

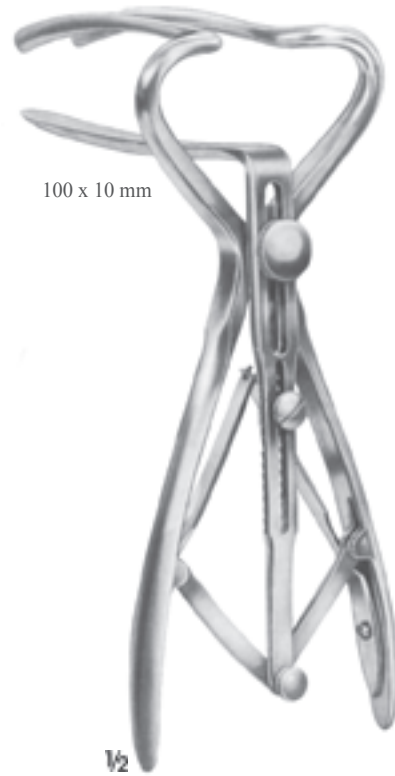

100 x 10 mm

COCK
BM-4600
19 cm



HIRSCHMANN
BM-4700 Ø 16 x 65 mm
BM-4701 Ø 19 x 65 mm
BM-4702 Ø 22 x 65 mm



KELLY
BM-4800 Ø 22 x 50 mm
BM-4801 Ø 22 x 100 mm
BM-4802 Ø 22 x 140 mm





1/2
BENSAUDE
BM-4900 Ø 17 mm
BM-4901 Ø 20 mm
BM-4902 Ø 23 mm
Anoskoplar/Anoscopes
18.5 cm



1/2
IVES-FANSLER
BM-5001 Ø 24 mm
Anoskop/Anoscope
14.5 cm



1/2
KELLY
BM-5100 Ø 20 mm
Anoskop/Anoscope
16 cm



1/2
KELLY
BM-5101 Ø 25 mm
Sfinteroskop/Sphincteroscope
16 cm



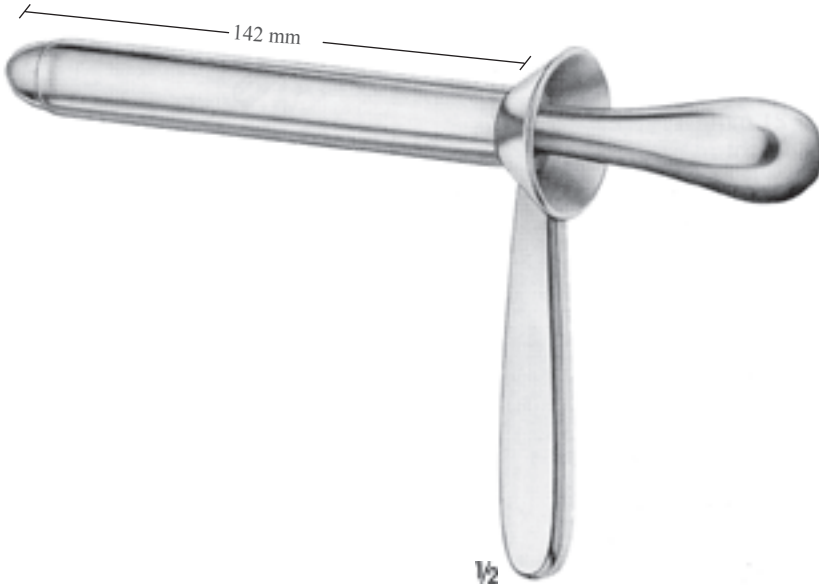

1/2
KELY
BM-5200
Proktoskop
Proctoscope
14 cm



1/1
BM-5405
ACM İngiliz standartı fiber ışık taşıyıcı
NAUNTON-MORGAN spekulum için
Fibre light attachment,
ACM/British standard
for NAUNTON-MORGAN specula

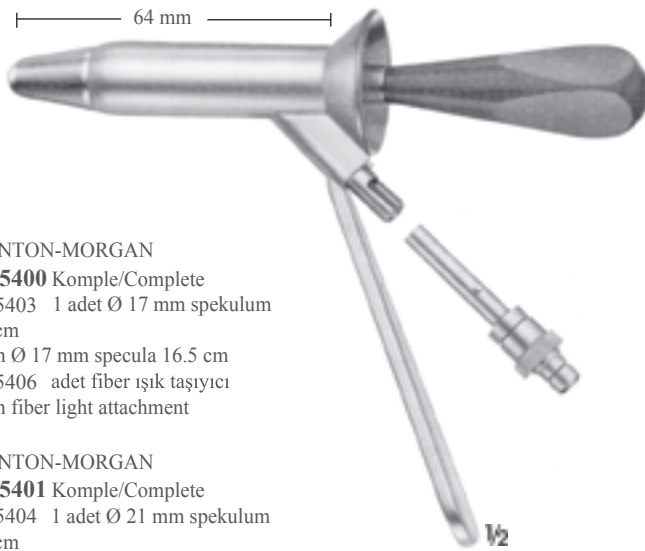

NAUNTON-MORGAN
BM-5400 Komple/Complete
BM-5403 1 adet Ø 17 mm spekulum
16.5 cm
1 each Ø 17 mm specula 16.5 cm
BM-5406 1 adet fiber ışık taşıyıcı
1 each fiber light attachment

NAUNTON-MORGAN
BM-5401 Komple/Complete
BM-5404 1 adet Ø 21 mm spekulum
16.5 cm
1 each, Ø 21 mm specula 16.5 cm
BM-5406 1 adet fiber ışık taşıyıcı
1 each fiber light attachment

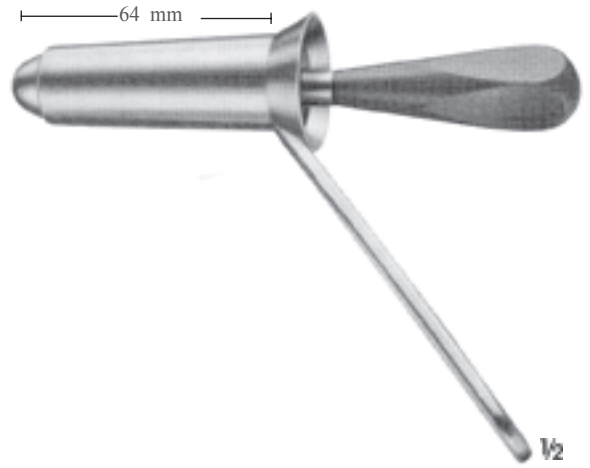

NAUNTON-MORGAN
BM-5402 Komple/Complete
BM-5405 1 adet Ø 24 mm spekulum
16.5 cm
1 each Ø 24 mm specula 16.5 cm
BM-5406 1 adet fiber ışık taşıyıcı
1 each fiber light attachment

1/2
GABRIEL
BM-5300 Ø 25 mm
Rektal spekulum
Rectal speculum

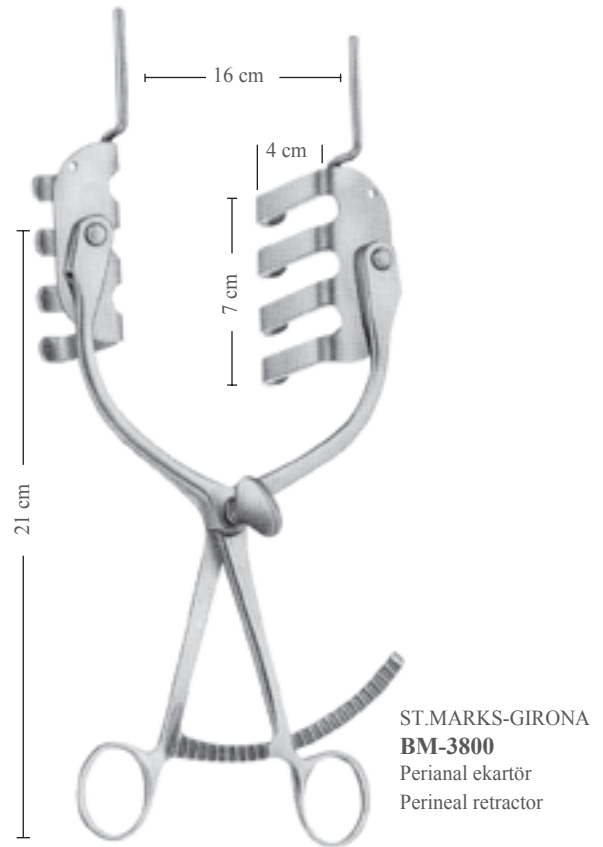
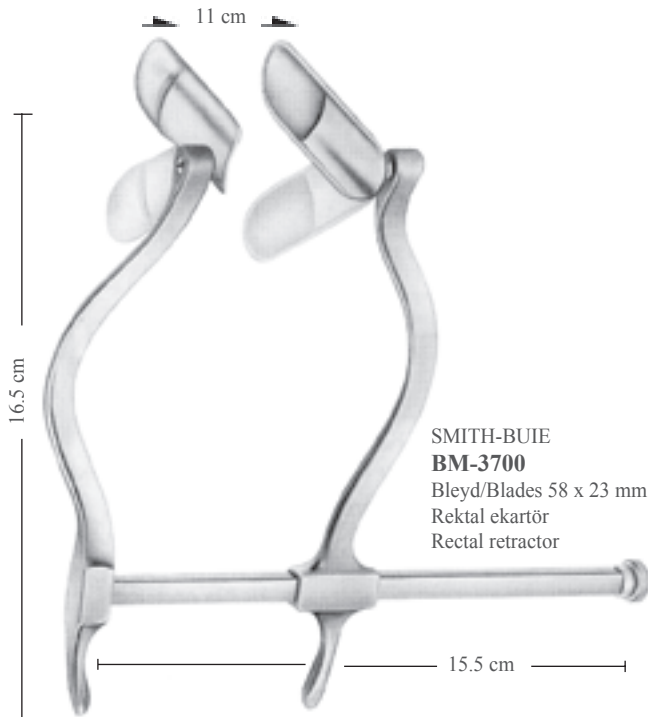
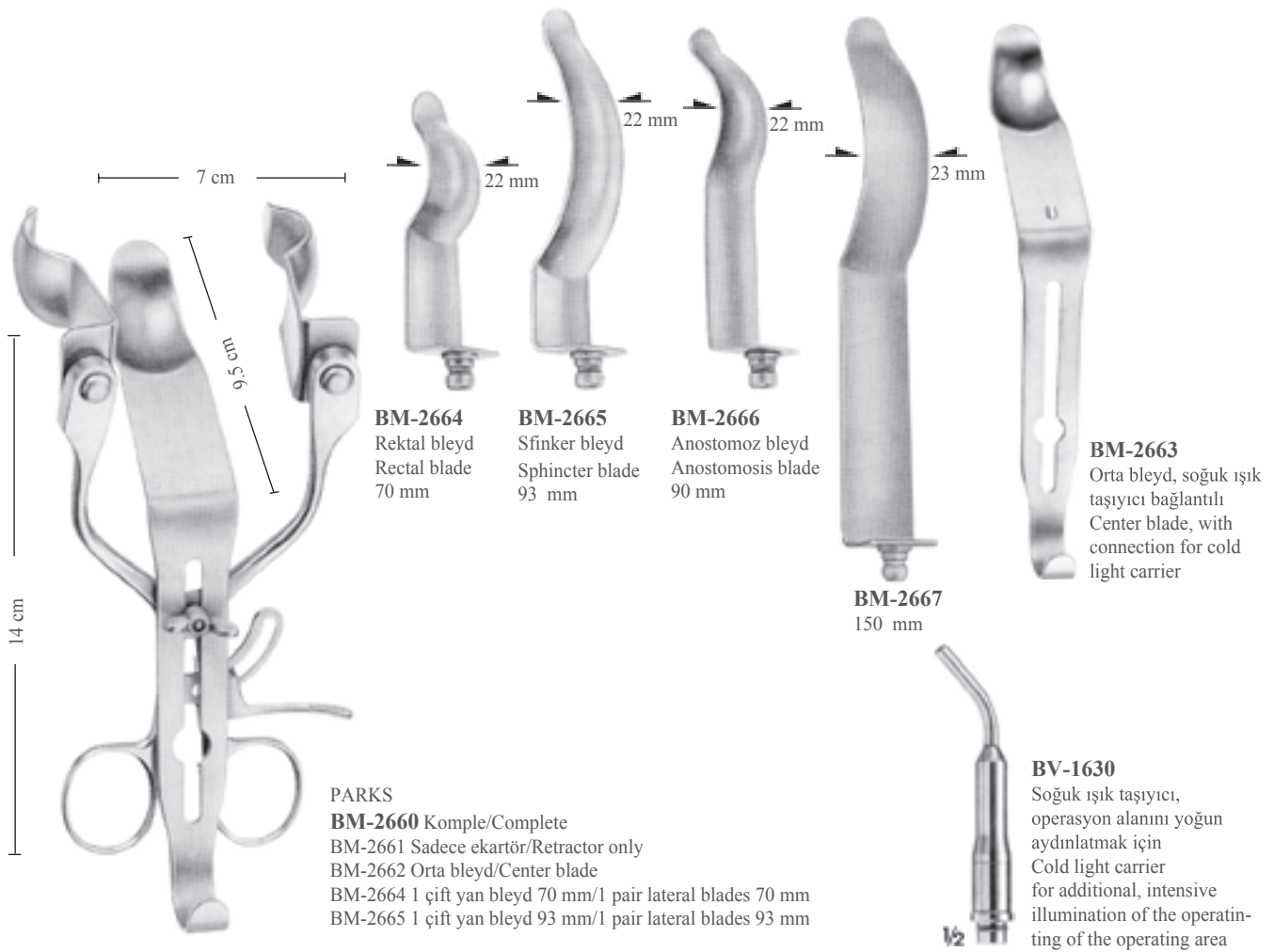

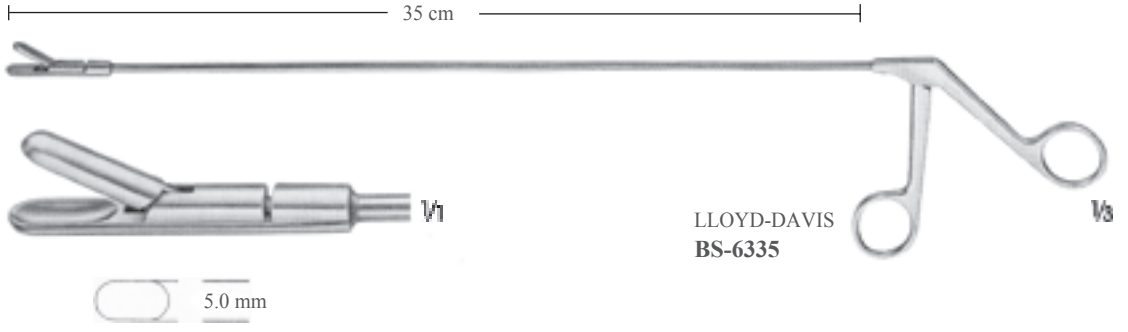

LLOYD-DAVIS
BS-6335

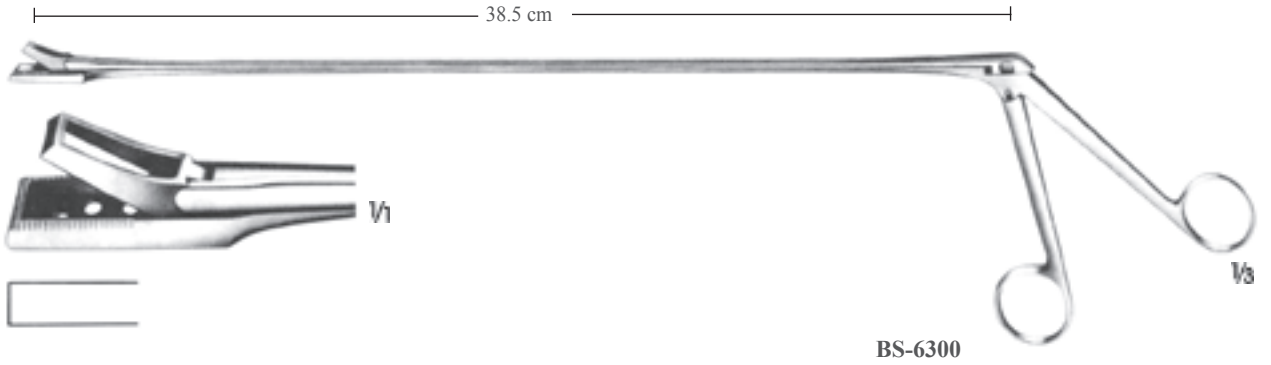

BS-6300

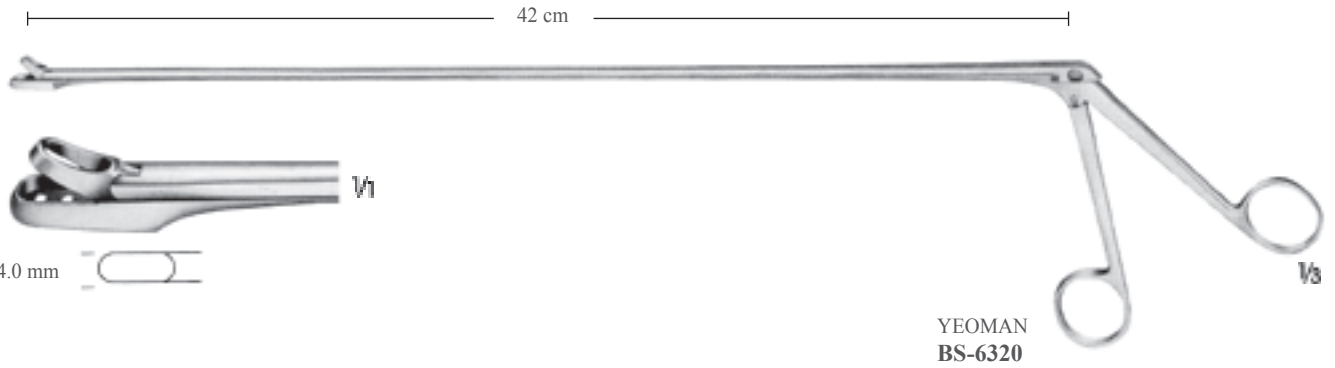

YEOMAN
BS-6320

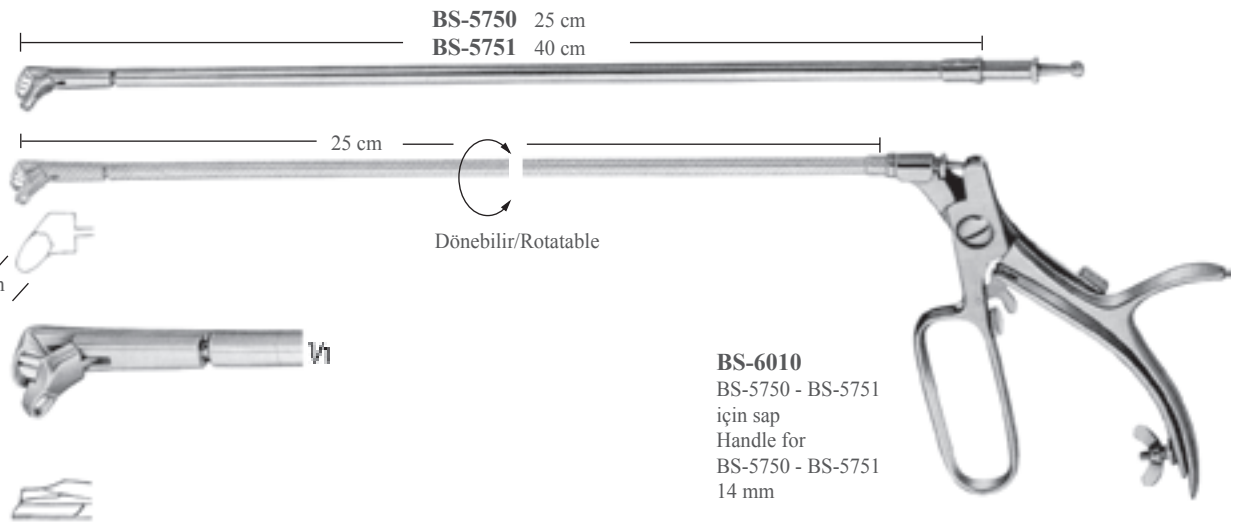

BS-6010
BS-5750 - BS-5751
için sap
Handle for
BS-5750 - BS-5751
14 mm

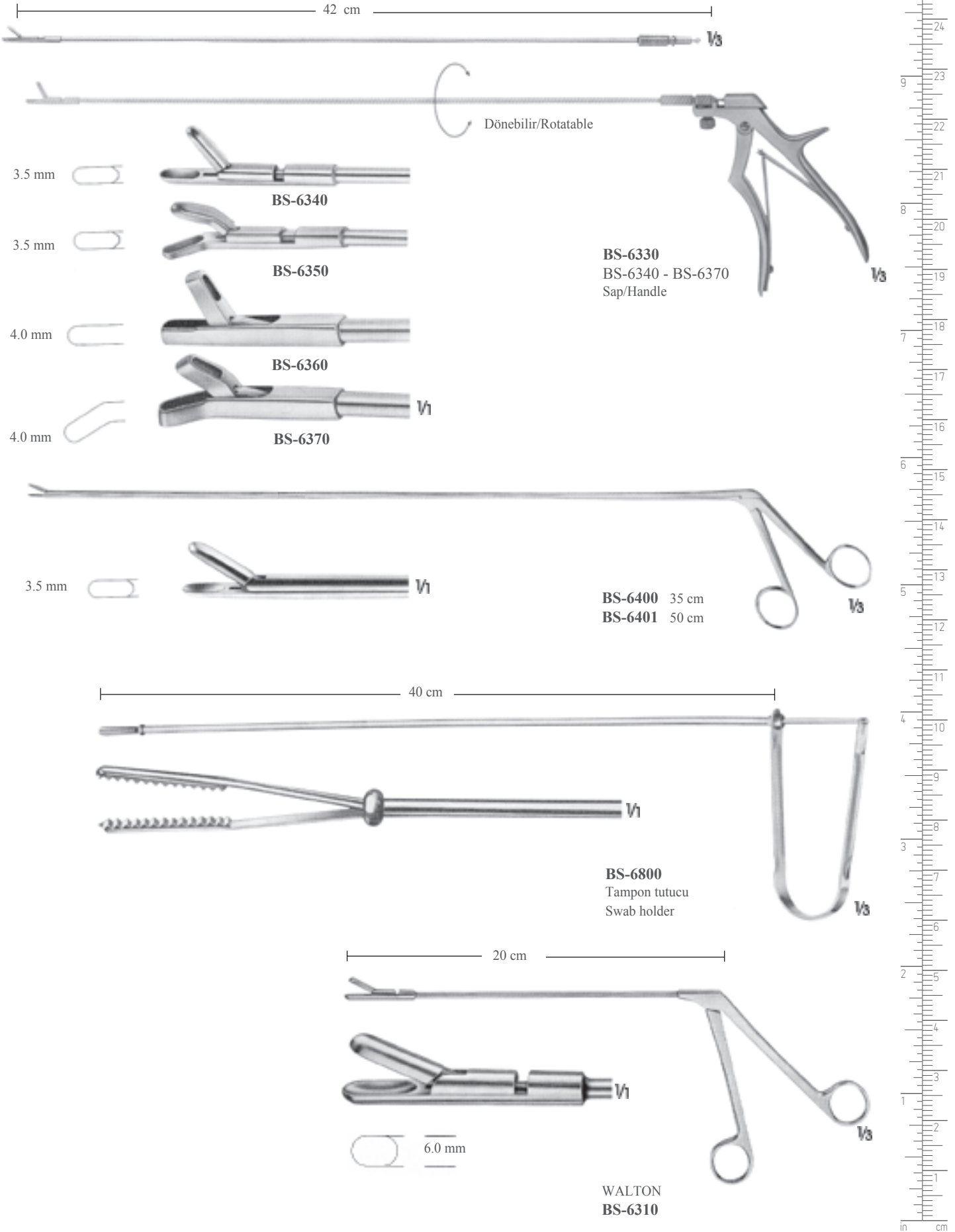

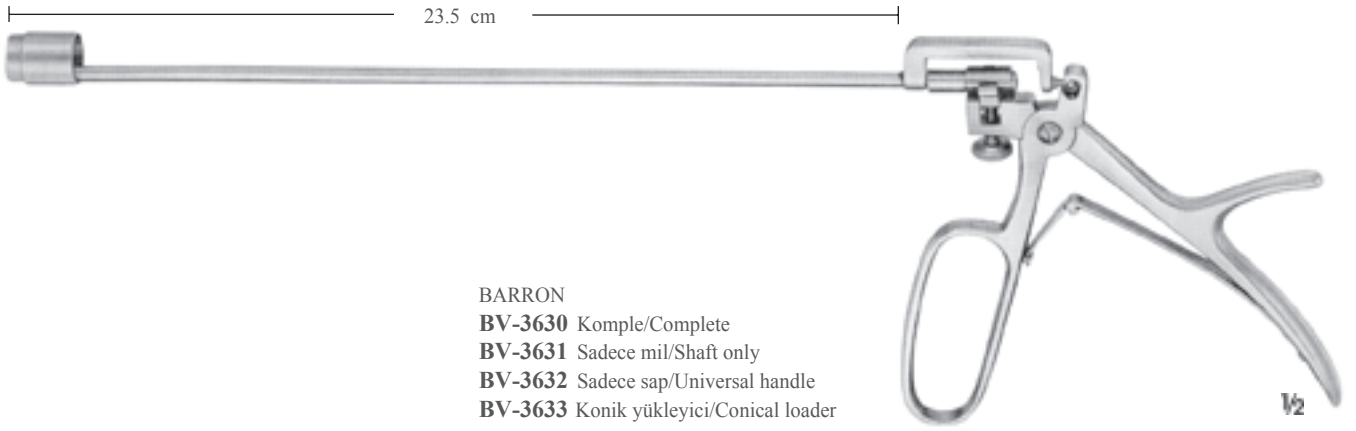

BARRON
BV-3630 Komple/Complete
BV-3631 Sadece mil/Shaft only
BV-3632 Sadece sap/Universal handle
BV-3633 Konik yükleyici/Conical loader

V2



MC GIVNEY
BG-4019
Hemoroid pens
Hemorrhoidal forceps
18.5 cm

V2



RUDD
BV-3531
Yükleme ekli 100 adet lastik halkası ile Hemoroid ligatörü
Hemorrhoidal ligatörü with loading attachment and 100 ligature rubber rings
31.5 cm

V2



V1

BV-3635
100 Adet/Paket
100 Pcs/Pack

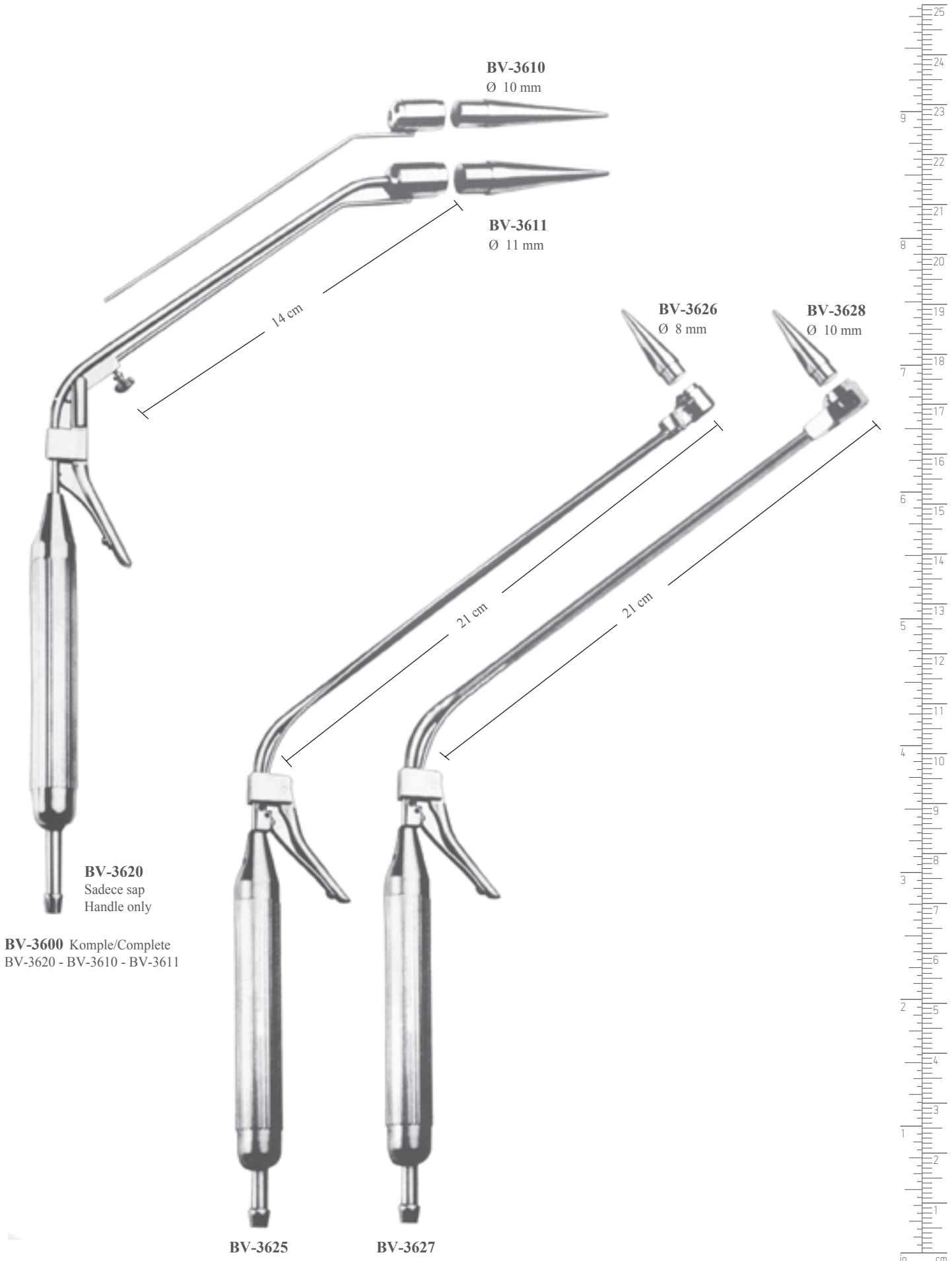



LOCKHART-MUMMERY
Fistül sonda/Fistula probes

BJ-1200 Nr.1 Düz/Straight

BJ-1245 Nr.2 45° Eğri/Curved

BJ-1290 Nr.3 90° Eğri/Curved

BJ-1295 Nr.4 Geriye doğru eğri/Curved retrograde
16.5 cm

Ø 3.5 mm



BIRODIE
BJ-1112
20 cm



BJ-1300
Bükülebilir/Malleable
19 cm

Ø 3 mm



BJ-1719
Çift delikli ve uçlu
bükülebilir sonda
Double ended probe,
malleable, with hole
19 cm

BK-1516
Fistül sonda
Fistula probe
24 cm

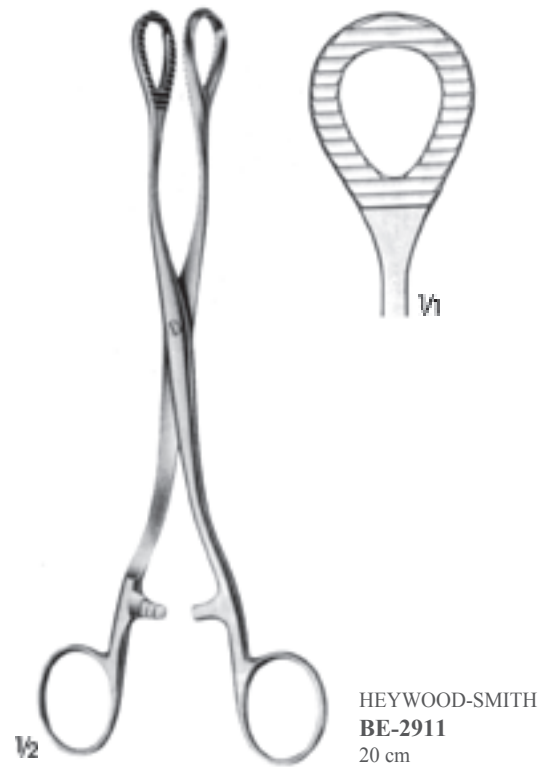
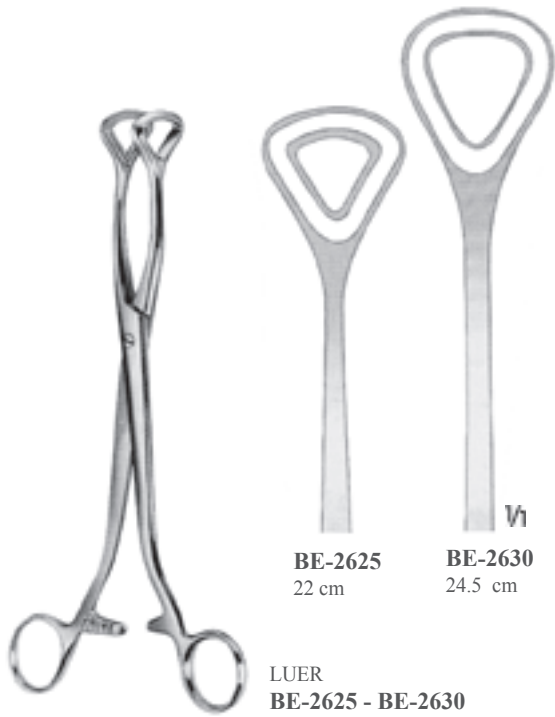

Atromatik
Atraumatic

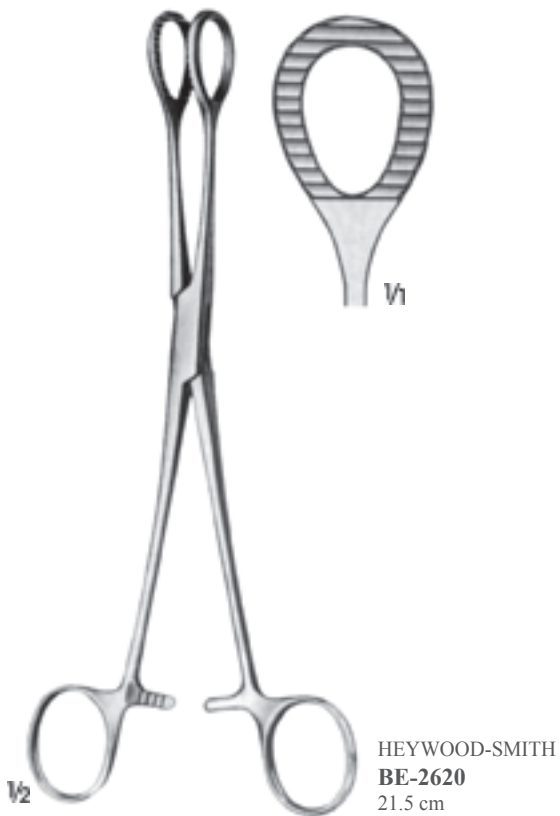

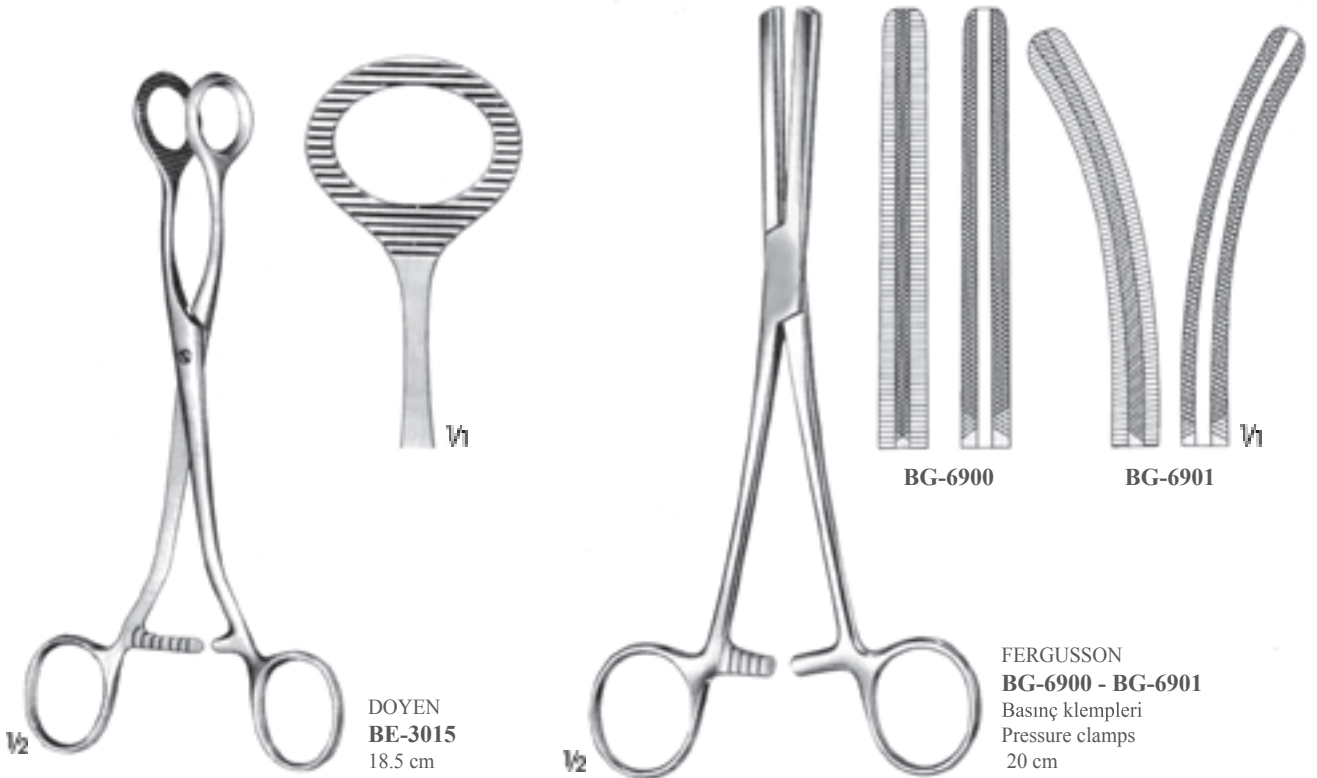
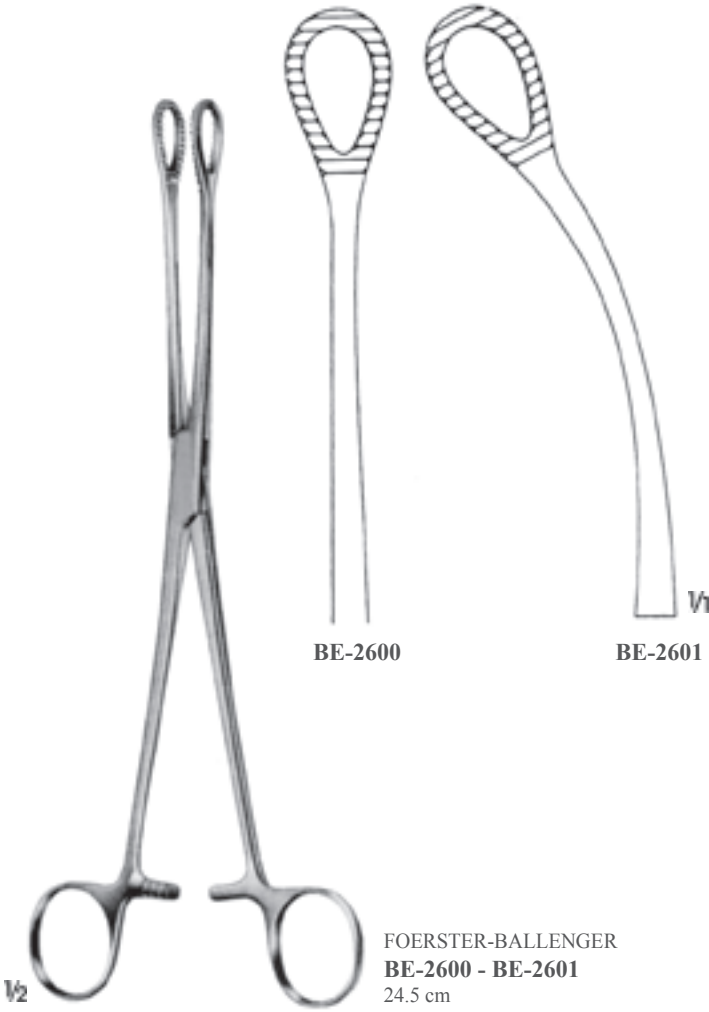

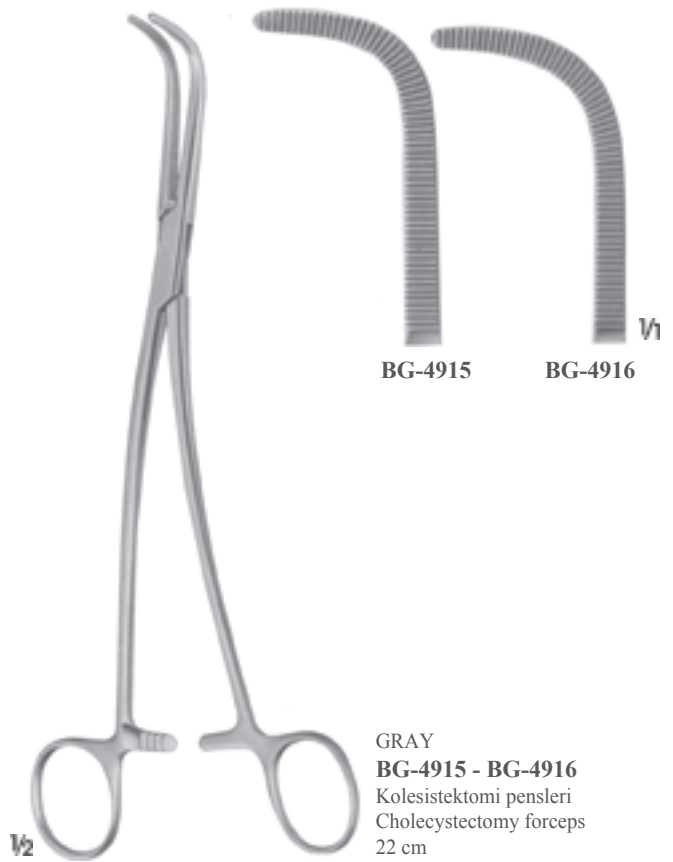



LOWER
BG-5015
18 cm



LAHEY(SWEET)
BG-5020
20 cm



LAHEY
BG-5022
22.5 cm



DESJARDINS
BG-5202
Ur kanalı ve kistik pens
Gall duct and cystic forceps
22 cm

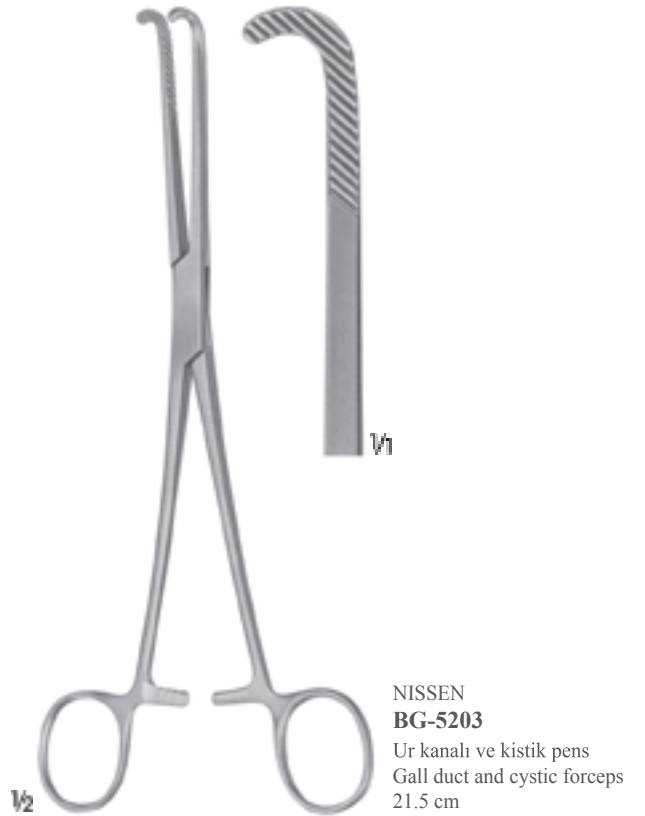

NISSEN
BG-5203
Ur kanalı ve kistik pens
Gall duct and cystic forceps
21.5 cm

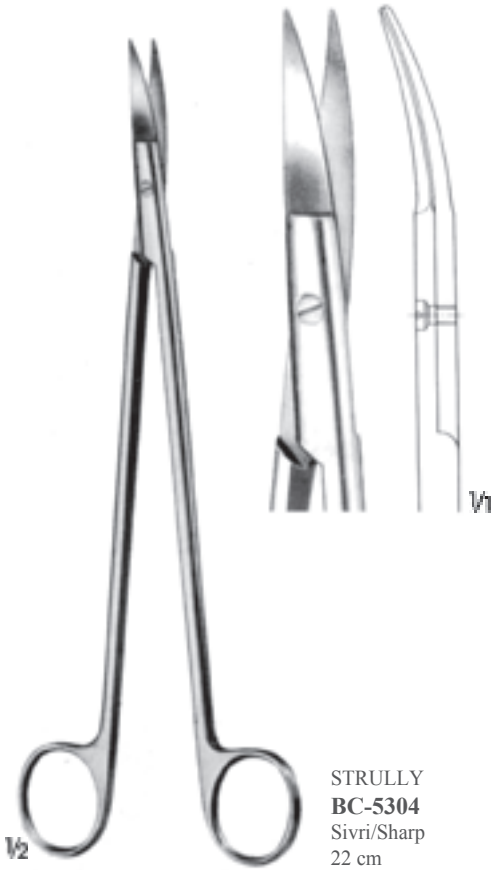

STRULLY
BC-5304
Sivri/Sharp
22 cm



BC-5308 Sivri/Sharp
Safra kesesi açıcı
For opening the gall
bladder
22.5 cm

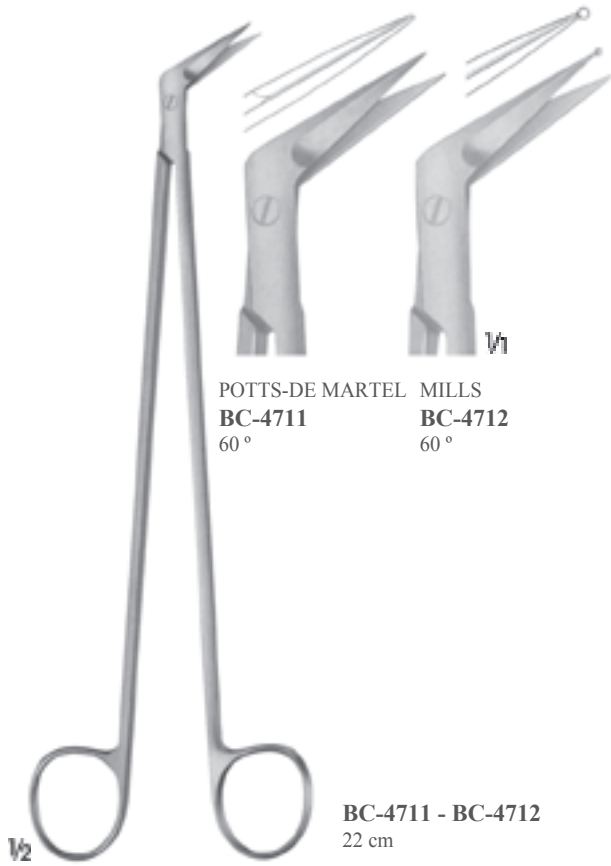

POTTS-DE MARTEL MILLS
BC-4711 **BC-4712**
60° 60°

BC-4711 - BC-4712
22 cm



 **HARDMODEL**

60°

DE BAKEY
BC-6522
22 cm





Ø 3.5 mm

V₂

**HAJEK
BJ-8200**
Sulama kanülü
Irrigating cannula
16.5 cm

BJ-2638
Ø 3.8 mm

BJ-2643
Ø 4.3 mm

BJ-2668
Ø 6.8 mm

Ø 5 mm

V₂

**MAYNIHAN
BJ-2430**
Safra taşı sondası, kaşık ağızlı
bükülebilir
Gall stone probe and-scoop
of tin, malleable
36.5cm

Ø 5 mm

V₂

**MAYO
BJ-8906**
Safra kanalı sonda
bükülebilir
Gall duct probe,
malleable
33 cm

Ø 3.5 mm

V₂

**OCHSNER
BJ-2435**
Safra kanalı sonda
esneyebilir
Gall duct probe, flexible
40 cm

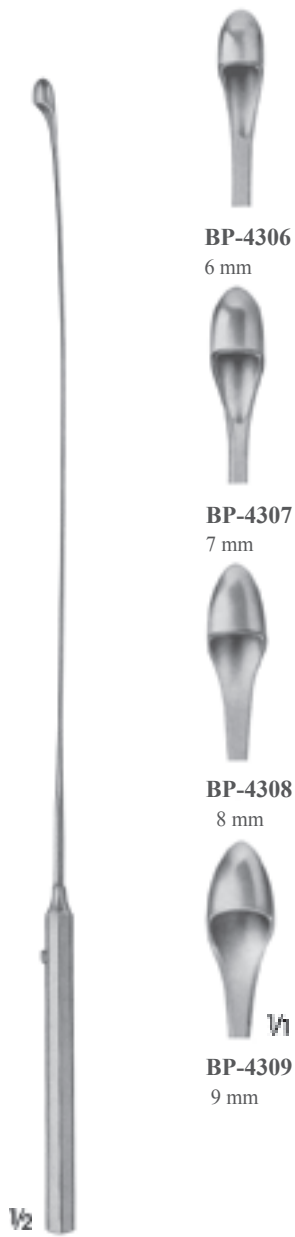

BP-4306
6 mm

BP-4307
7 mm

BP-4308
8 mm

BP-4309
9 mm

DESJARDINS
BP-4306 - BP-4309
Esnek şaft sonda ve yakalayıcı
Probe and catch with flexible shaft
30 cm



LUER-KÖRTE
BP-4400 - BP-4407
Bükülebilir/Malleable
31 cm

Fig. 000



BP-4400
2.8 mm

Fig. 0



BP-4402
4.3 mm

Fig. 2



BP-4404
6.7 mm

Fig. 4



BP-4406
11 mm

Fig. 00



BP-4401
3.4 mm

Fig. 1



BP-4403
5.5 mm

Fig. 3



BP-4405
8.0 mm

Fig. 5



BP-4407
15 mm



BAKES
BJ-8740 - BJ-8752
Safra kanalı için bükülebilir dilatörler
Common bile duct dilators, malleable
31 cm

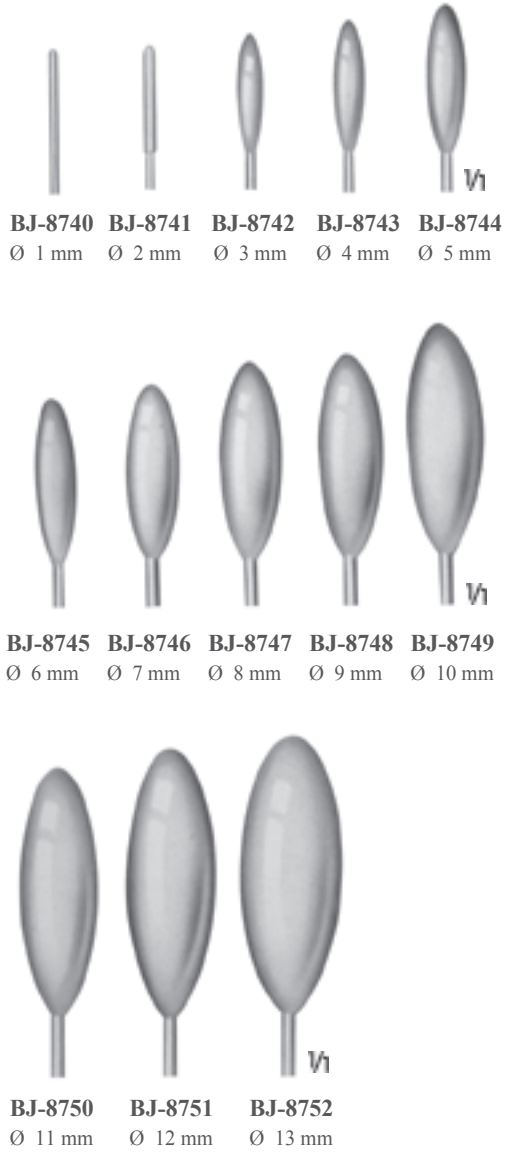

BJ-8740 **BJ-8741** **BJ-8742** **BJ-8743** **BJ-8744**
Ø 1 mm Ø 2 mm Ø 3 mm Ø 4 mm Ø 5 mm

BJ-8745 **BJ-8746** **BJ-8747** **BJ-8748** **BJ-8749**
Ø 6 mm Ø 7 mm Ø 8 mm Ø 9 mm Ø 10 mm

BJ-8750 **BJ-8751** **BJ-8752**
Ø 11 mm Ø 12 mm Ø 13 mm



DITTEL
BJ-2708 - BJ-2730
Metal buji ve dilatasyon sondaları
Metal bougies and dilating sounds
34.5 cm

Charr. (French)	
8	BJ-2708
9	BJ-2709
10	BJ-2710
11	BJ-2711
12	BJ-2712
13	BJ-2713
14	BJ-2714
15	BJ-2715
16	BJ-2716
17	BJ-2717
18	BJ-2718
19	BJ-2719
20	BJ-2720
21	BJ-2721
22	BJ-2722
23	BJ-2723
24	BJ-2724
25	BJ-2725
26	BJ-2726
27	BJ-2727
28	BJ-2728
29	BJ-2729
30	BJ-2730

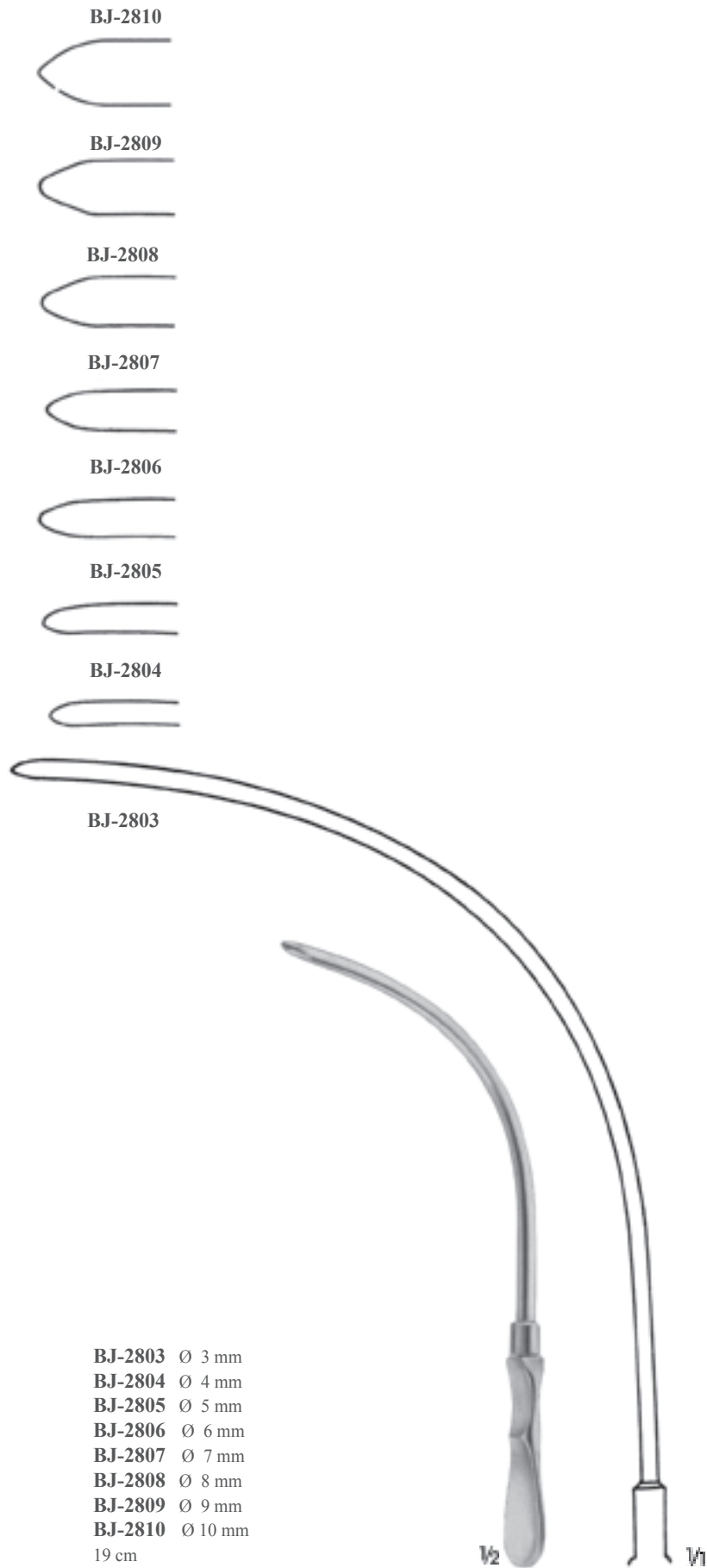

BJ-2810

BJ-2809

BJ-2808

BJ-2807

BJ-2806

BJ-2805

BJ-2804

BJ-2803

- BJ-2803** Ø 3 mm
 - BJ-2804** Ø 4 mm
 - BJ-2805** Ø 5 mm
 - BJ-2806** Ø 6 mm
 - BJ-2807** Ø 7 mm
 - BJ-2808** Ø 8 mm
 - BJ-2809** Ø 9 mm
 - BJ-2810** Ø 10 mm
- 19 cm

W2

W1



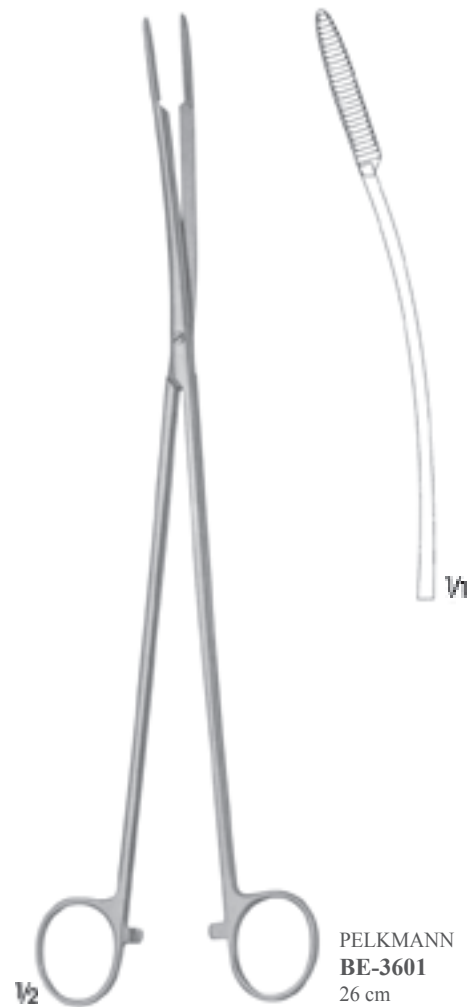
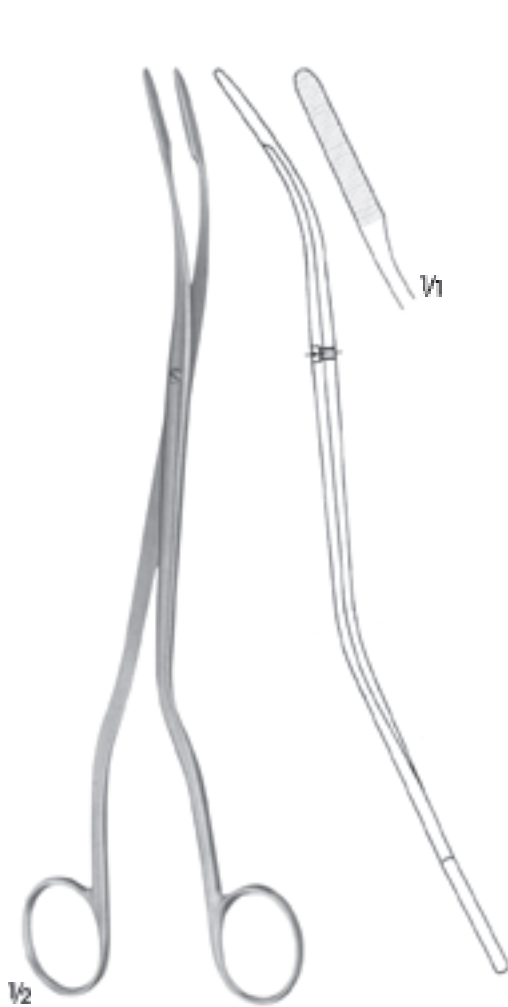
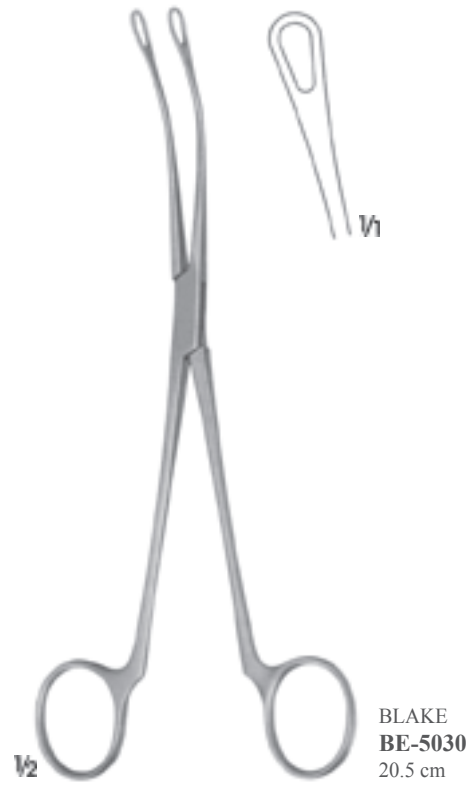
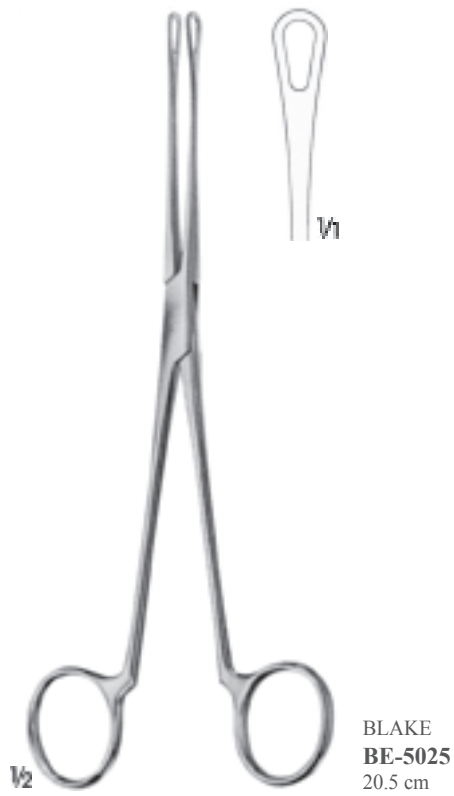



BE-5001 BE-5003



BE-5002 BE-5004



BE-5006
24 cm



BE-5005
22.5 cm



DESJARDINS
BE-5001 - BE-5004
22.5 cm



DESJARDINS
BE-5005 - BE-5006
Hassas model
Extremely delicate patterns



TÜBINGER
BE-5010
25.5 cm

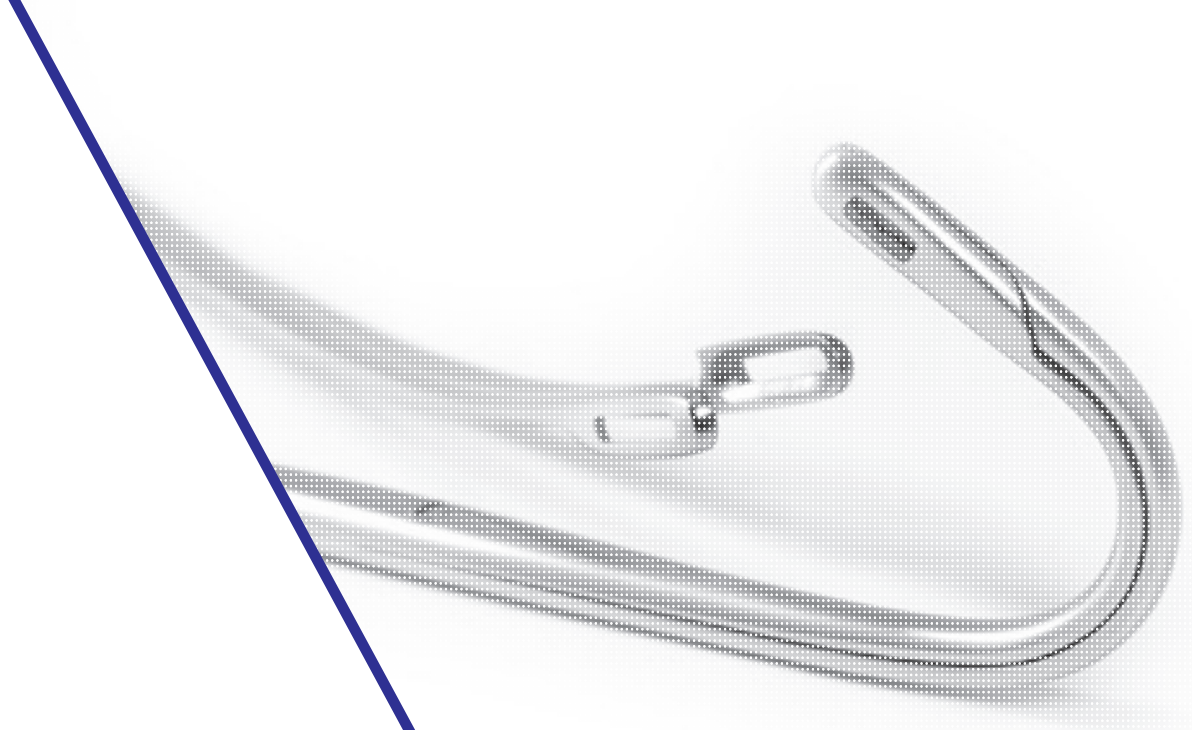

GU

Ürolojik Aletler
Genito-Urinary Instruments

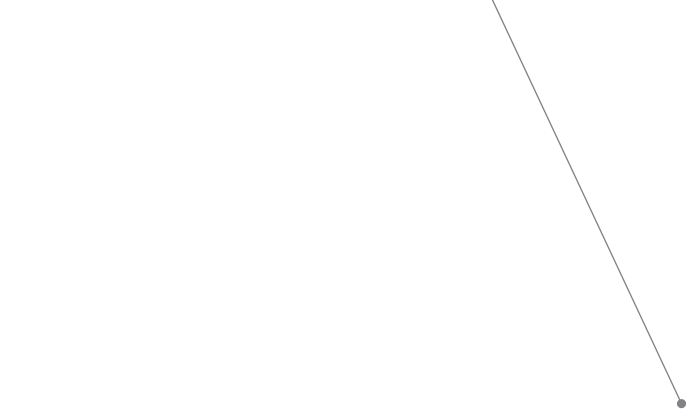



BG-3819
19.5 cm



BG-3822
22 cm



BG-3823
23 cm



V1



PEAN
BG-3819 - BG-3823



V2

GUYON
BG-4006
23.5 cm

Atromatik
Atraumatic



GUYON
BG-4007
23 cm



GUYON
BG-4008 - BG-4010



BG-4010
23 cm





STILLE
BG-4011
22 cm



STILLE
BG-4012
24 cm

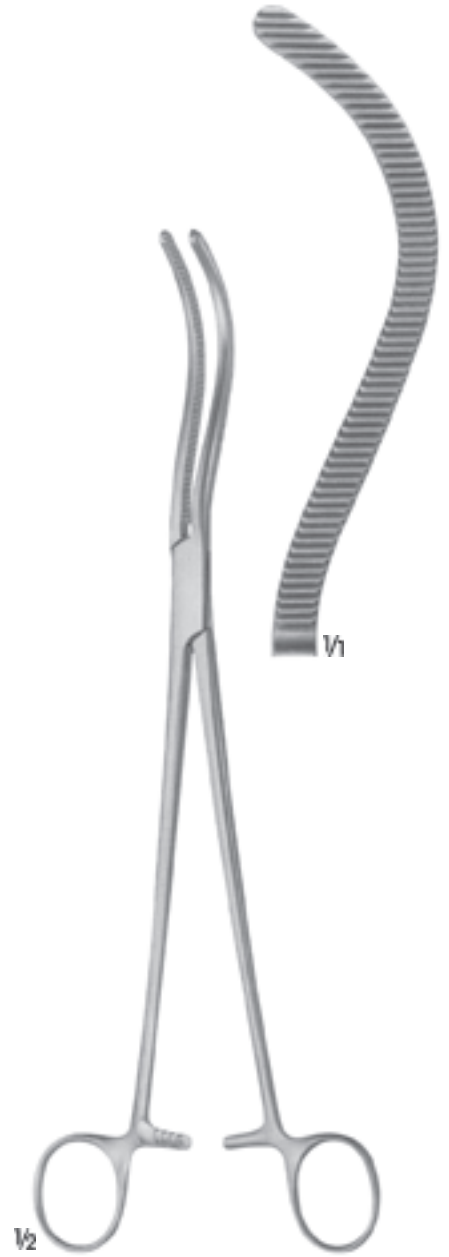

GUYON
BG-4013
26.5 cm



HERRICK
BG-4017
22.5 cm



WERTHEIM
BG-6600
25.5 cm





WERTHEIM - CULLEN
BG-6620
Açılı baskı klempli
Angle- and pressure clamp
21.5 cm

Atromatik
Atraumatic



WERTHEIM
BG-6615
Açılı baskı klempli
Angle- and pressure clamp
25 cm



DARTIGUES
BE-4809
25.5 cm



COLLIN
BE-4810
28.5 cm





BE-4820
17 cm



BE-4825
16 cm



HEIMING
BE-4820 - BE-4825
Çocuklar için/For children



RANDALL
BE-4900 - BE-4903
22.5 cm



BE-4900



BE-4901



BE-4902



BE-4903





BM-2653
57 x 25 mm



BM-2653
57 x 25 mm



BM-2654
82 x 25 mm



BM-2654
82 x 25 mm

MILLIN
BM-2650 Komple/Complete
BM-2652 Sadece ekartör/Retractor only
BM-2653 Bleyd 57 x 25 mm/Blades 57 x 25 mm
BM-2654 Bleyd 82 x 25 mm/Blades 82 x 25 mm
BM-2655 Orta bleyd 105 x 45 mm/Center blade 105 x 45 mm

MILLIN
BM-2651 Komple/Complete
Işık taşıyıcılı/With light carrier
BM-2652 Sadece ekartör/Retractor only
BM-2653 Bleyd 57 x 25 mm/Blades 57 x 25 mm
BM-2654 Bleyd 82 x 25 mm/Blades 82 x 25 mm
BM-2656 Orta bleyd 105 x 45 mm/Center blade 105 x 45 mm



67 mm

V2

KOCHER
BK-8730
Mesane ekartör
Bladder retractor
26 cm

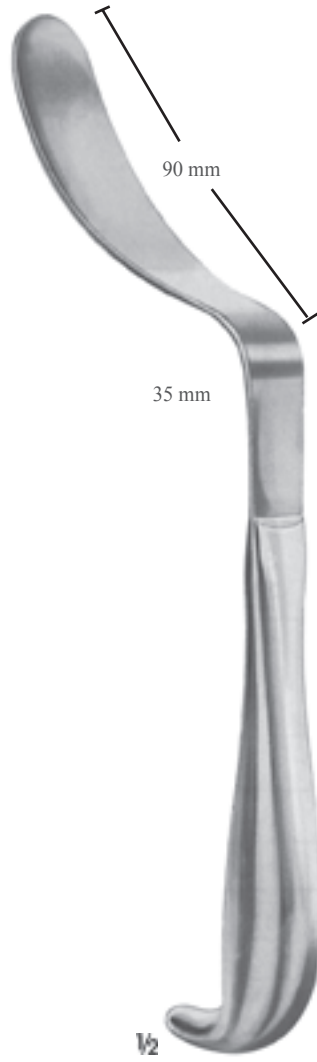

90 mm

35 mm

V2

LEGUEU
BK-8735
Mesane spatula
Bladder spatula
26 cm



V2

MILLIN
BM-2740
Mesane ayırıcı
Bladder neck spreader
28.5 cm





Atromatik
Atraumatic

Atromatik
Atraumatic

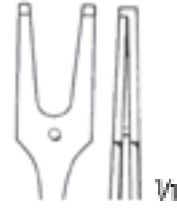

MILLIN
BE-4623
Lobe yakalama pensi
Lobe grasping forceps
23.5 cm

MILLIN
BE-4624
Lobe tutma pensi
Lobe grasping forceps
24.5 cm

MILLIN
BF-6320
Bağ tutucu pensi
Ligature holding forceps
24.5 cm





$\frac{1}{2}$
YOUNG
BK-8885
21 cm



$\frac{1}{2}$
YOUNG
BK-8895
21 cm



$\frac{1}{2}$
BK-8745
Prostat ekartör
Prostate retractor
36 cm



$\frac{1}{2}$
BK-8755
Üretral ekartör
Urethral retractor
39 cm





BG-3206
Venöz plexus klemp
Venous plexus clamp
21 cm

BARRE
BG-4900 - BG-4901
Diseksiyon pensleri
Dissecting forceps
28 cm

BARRE
BC-5301
Diseksiyon makası
Dissecting scissors
28 cm



BARRE
BB-1121
No.3 XL
Sol el için
For left hand
25 cm



BARRE
BB-1122 - BB-1125
No.3 XL
Sol el için
For left hand
25 cm



BB-1122
12°

BB-1125
25°



BF-6307



BF-6308



BF-6309



1/2

YOUNG-HRYNTSCHAK
BF-6310
1 iğne ile BF-6307
With 1 needle BF-6307
24 cm



Ucu tam izoleli
Fully insulated

1/2

BARRE
BZ-1260
Bipolar penset
Bipolar forceps
26 cm





BR-7880
Ø 4.8 mm
Penis ucu ve sünnet derisi
tutma pensi
Forceps for grasping the glans
and the foreskin
12.5 cm



BR-7881
Testis sabitleme klemp
Fixation clamp for the
spermatic cord
14.5 cm



BK-1451
Testis bağlayıcı huk
Hook for the spermatic cord
16.5 cm

Atromatik
Atraumatic

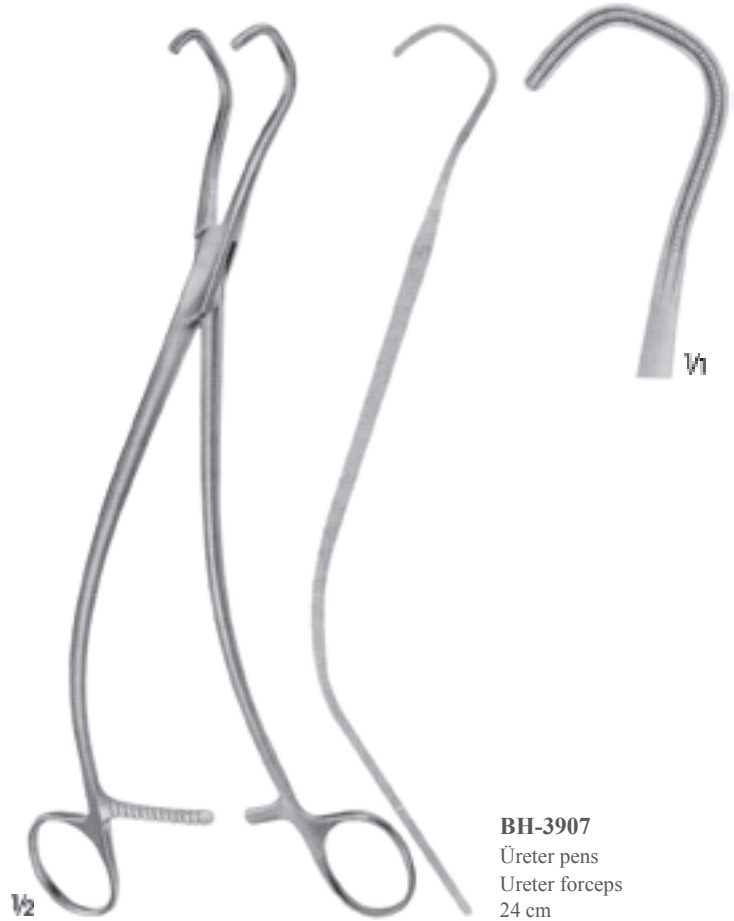

BH-3907
Üreter pens
Ureter forceps
24 cm

- İki adet hemostatik veya ligatür pens yardımı ile sünnet derisi çan şeklindeki koruma çubuğu üzerine çekilir ve glans yuvaya yerleştirilir.
 - Bu şekilde, kelebek somun sıkılarak, olabildiğince kapama sağlanır. Böylelikle sünnet derisi halka şeklinde sıkıştırılır. Sünnet derisi bistüri yardımı ile sıkma çemberinin hemen kenarından kesilir.
 - Sünnet çanı kanamayı önlemek amacı ile bir kaç dakika bekletilir. Özellikle frenular arter damarının büyük olması ve kesilmesi gerektiği durumlarda dikiş takımı hazır bulundurulmalıdır.
 - Tanımlanan metodun avantajı, küçük ölçü dokunun bıraktığı yara izinin estetik olarak uygun olmasıdır.
-
- Foreskin is pushed over the bell-shaped protection rod with the help of two hemostatic or ligature forceps and the glans is placed into cavity on the rod.
 - In this position, wing nut is tightened as close as possible for guaranteeing annular copression on the foreskin. Then foreskin is cut off with scalpel, right next to the compression ring.
 - The circumcision clamp is kept in compressed position for few minutes for avoiding bleeding. In case of large vein of frenular artery is cut through, the ligature set should be kept ready.
 - The advantage of the method described is aesthetically favorble scar after opretion.



WINKELMANN
BV-2912 Ø 12 mm
BV-2916 Ø 16 mm
BV-2920 Ø 20 mm
Sünnet klempleri
Circumcision clamps

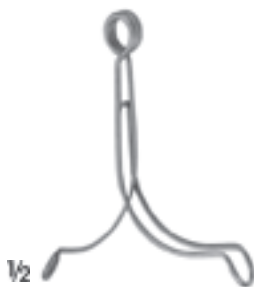

STOCKMANN
BV-2740
Penis klemp
Penis clamp
7 cm



STRAUSS
BV-2741
Penis klemp
Penis clamp
13 cm



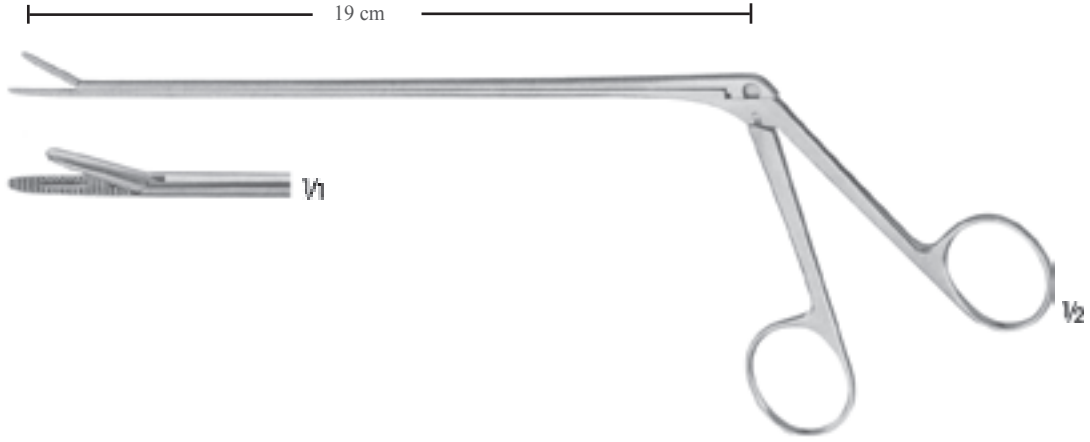

MATHIEU
BS-6100
Yabancı cisim pensi
Foreign body forceps
19 cm



PITHA
BE-3535
Yabancı cisim pensi
Foreign body forceps
22 cm



ASCH
BP-7740
Uterin kaşık küret, küt
Uterine secretion scoop, blunt
20 cm



BJJ-2903 - BE-2906
Uterin sonda
Uterine probe
33 cm



	Charr.
BJ-3201	8
BJ-3202	10
BJ-3203	12
BJ-3204	14
BJ-3205	16
BJ-3206	18
BJ-3207	20

BJ-3201 - BJ-3207
Erkekler için metal katater
Male catheters, metal
29 cm



	Charr.
BJ-3306	6
BJ-3307	7
BJ-3308	8
BJ-3309	9
BJ-3310	10
BJ-3311	11
BJ-3312	12
BJ-3313	13
BJ-3314	14
BJ-3315	15
BJ-3316	16
BJ-3318	18
BJ-3320	20

BJ-3306 - BJ-3320
Bayanlar için metal katater
Female catheters, metal
15.5 cm



BJ-3349
Katater kılavuz
Catheter guide
49 cm





GUYON
BJ-3400
Katater klavuz
Catheter guide
36.5 cm



BJ-3500
Katater için uygulayıcı
Introducer for catheters
46 cm



DITTEL
BJ-2708 - BJ-2730
Üretral dilatasyon bujileri
Urethral dilating bougies
34.5 cm

Charr.

BJ-2708	8
BJ-2709	9
BJ-2710	10
BJ-2711	11
BJ-2712	12
BJ-2713	13
BJ-2714	14
BJ-2715	15
BJ-2716	16
BJ-2717	17
BJ-2718	18
BJ-2719	19
BJ-2720	20
BJ-2721	21
BJ-2722	22
BJ-2723	23
BJ-2724	24
BJ-2725	25
BJ-2726	26
BJ-2727	27
BJ-2728	28
BJ-2729	29
BJ-2730	30



1/2

GUYON
BJ-3024 - BJ-3060
Üretral dilatasyon bujileri
Urethral dilating bougies
25.5 cm

BJ-3024	Ben 24/ Charr.12
BJ-3025	Ben.25
BJ-3026	Ben 26/ Charr.13
BJ-3027	Ben.27
BJ-3028	Ben 28/ Charr.14
BJ-3029	Ben.29
BJ-3030	Ben 30/ Charr.15
BJ-3031	Ben.31
BJ-3032	Ben 32/ Charr.16
BJ-3033	Ben.33
BJ-3034	Ben 34/ Charr.17
BJ-3035	Ben.35
BJ-3036	Ben 36/ Charr.18
BJ-3037	Ben.37
BJ-3038	Ben 38/ Charr.19
BJ-3039	Ben.39
BJ-3040	Ben 40/ Charr.20
BJ-3041	Ben.41
BJ-3042	Ben 42/ Charr.21
BJ-3043	Ben.43
BJ-3044	Ben 44/ Charr.22
BJ-3045	Ben.45
BJ-3046	Ben 46/ Charr.23
BJ-3047	Ben.47
BJ-3048	Ben 48/ Charr.24
BJ-3049	Ben.49
BJ-3050	Ben 50/ Charr.25
BJ-3051	Ben.51
BJ-3052	Ben 52/ Charr.26
BJ-3053	Ben.53
BJ-3054	Ben 54/ Charr.27
BJ-3055	Ben.55
BJ-3056	Ben 56/ Charr.28
BJ-3057	Ben.57
BJ-3058	Ben 58/ Charr.29
BJ-3059	Ben.59
BJ-3060	Ben 60/ Charr.30



1/2

TURNER WARWICK
BJ-3100
Gerici buji
Retrograde bougie
18 cm



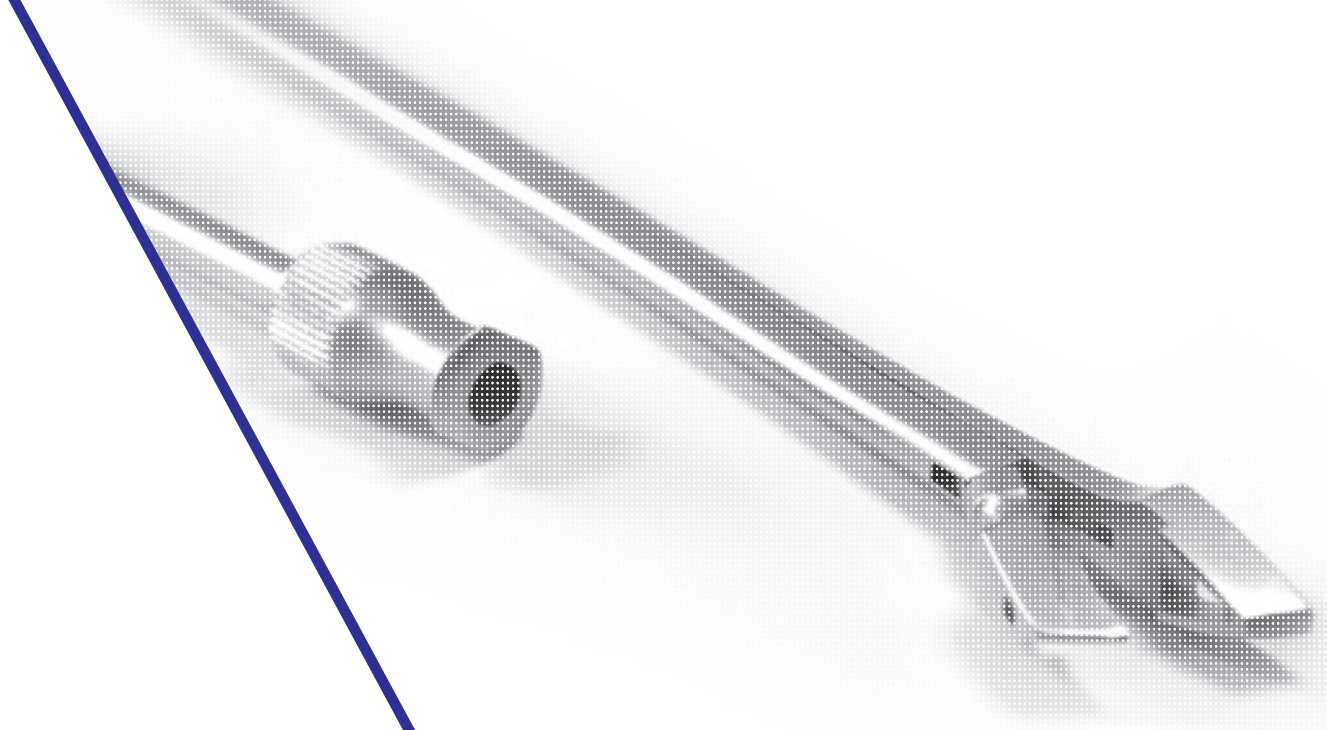

GY

Jinekolojik Aletler
Gynaecological Instruments





	Vajinal Spekulum için ölçü sistemi Uzunluk: 1 Genişlik: 2 Örnek: 1 x 2 mm	Measurement system for Vaginal Specula Length : 1 Width : 2 Example: 1 x 2 mm
--	---	---



COLLIN
BM-5500
53 x 10 mm
Çocuklar için/For children



COLLIN
BM-5600
95/85 x 18 mm
Bakireler için/For virgins

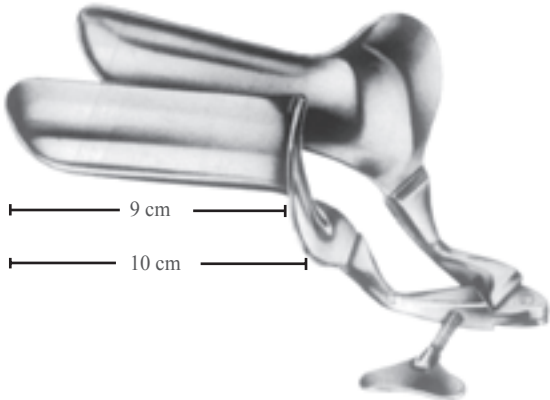

COLLIN	Tam boy/Çalışma boy Total lenght/Working length	En Width
BM-5701	100/90 mm	28 mm
BM-5702	100/90 mm	32 mm
BM-5703	105/95 mm	35 mm
BM-5704	115/105 mm	40 mm



TRELAT
BM-6801 85 x 33 mm
BM-6802 95 x 35 mm
BM-6803 115 x 43 mm



CUSCO
BM-5800
75 x 17 mm
Bakireler için/For virgins



CUSCO
BM-6200
75 x 17 mm
Bakireler için/For virgins



CUSCO STANDARD
BM-5901 80 x 24 mm
BM-5902 80 x 32 mm
BM-5903 90 x 36 mm
BM-5904 110 x 37 mm
Standart model
Standard patterns

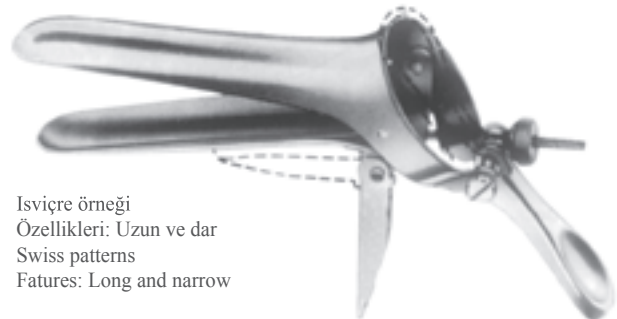

İsviçre örneği
Özellikleri: Uzun ve dar
Swiss patterns
Fatures: Long and narrow

CUSCO
BM-6001 92 x 23 - 25 mm
BM-6002 100 x 25 - 27 mm
BM-6003 110 x 27 - 30 mm





CUSCO
BM-6101 80 x 32 mm
BM-6102 90 x 37 mm
BM-6103 115 x 37 mm
Yassı (Ördek gagası)
Flat (Duck beak)

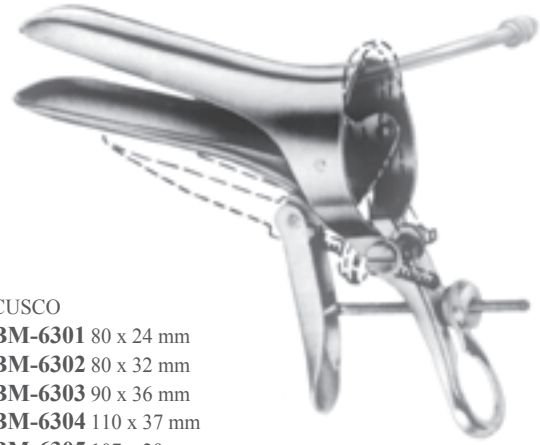

CUSCO
BM-6301 80 x 24 mm
BM-6302 80 x 32 mm
BM-6303 90 x 36 mm
BM-6304 110 x 37 mm
BM-6305 107 x 29 mm
BM-6306 115 x 35 mm
Aspiratör uçlu/With suction tube



GRAVE
BM-6901 75 x 20 mm
BM-6902 95 x 30 mm
BM-6903 105 x 33 mm



PEDERSON
BM-7001 100 x 22 mm
BM-7002 120 x 25 mm



Parmak baskısıyla açılıp kapanan çift işaretli
With double ratchet, closing and opening of
ratchet by pressure of thumb

SEMM
BM-6401
90 x 14 -18 mm
Çocuk ve bakireler için
For children and virgins



Parmak baskısıyla açılıp kapanan çift işaretli
With double ratchet, closing and opening of
ratchet by pressure of thumb

SEMM
BM-6501 100 x 20 - 24 mm
BM-6502 100 x 30 - 34 mm
18.5 cm



SEYFFERT
BM-6601 100 x 17 mm
BM-6602 100 x 33 mm
23 cm

Alet ve kataterleri çıkarmak için bir tarafı açık
One side open for faking up instruments and
catheters

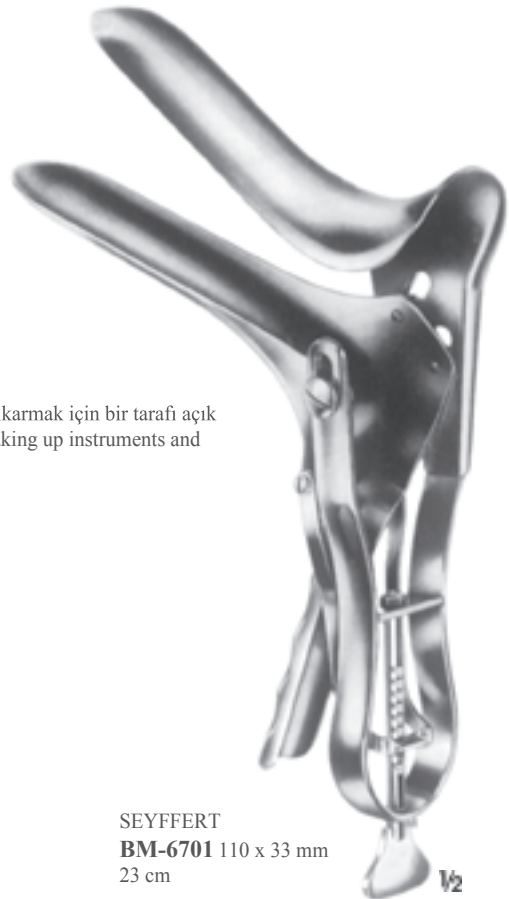

SEYFFERT
BM-6701 110 x 33 mm
23 cm





SEIDL

- BK-8940** 80 x 8 mm
 - BK-8941** 80 x 10 mm
 - BK-8942** 90 x 14 mm
- Çocuklar ve bebekler için
For children and infants
17 cm

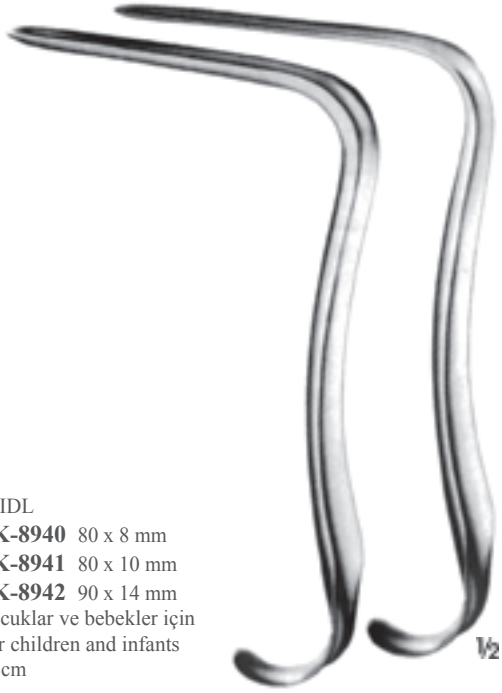

KRISTELLER

- BK-8950** 70 x 15 mm
- Çocuklar için
For children
17 cm



KRISTELLER

- BK-8951** 70 x 27 mm
 - BK-8952** 75 x 30 mm
 - BK-8953** 90 x 36 mm
- 17.5 cm



KRISTELLER

- BK-8960** 110 x 18 mm
 - BK-8961** 110 x 20 mm
 - BK-8962** 110 x 27 mm
 - BK-8963** 110 x 30 mm
 - BK-8964** 110 x 36 mm
- 22 cm



KRISTELLER
BK-8990 - BK-8993
Üst bleyd/Upper blades



BK-8990
75 x 10 mm
17.5 cm



BK-8991
75 x 23 mm
18 cm



BK-8992
80 x 25 mm
18 cm



BK-8993
100 x 32 mm
18.5 cm



KRISTELLER
BK-8970 - BK-8973
Alt bleyd/Lower blade



BK-8970
70 x 15 mm
17.5 cm



BK-8971
70 x 27 mm
18 cm



BK-8972
75 x 30 mm
18 cm



BK-8973
90 x 36 mm
18.5 cm





KRISTELLER
BK-9010 - BK-9014
Üst bleyd/Upper blades

BK-9010
115 x 14 mm
21.5 cm

BK-9011
115 x 23 mm
21.5 cm

BK-9012
115 x 16 mm
22 cm

BK-9013
115 x 26 mm
22 cm

BK-9014
120 x 30 mm
22.5 cm



V₂



KRISTELLER
BK-8980 - BK-8984
Alt bleyd/Lower blades

BK-8980
110 x 18 mm
21.5 cm

BK-8981
110 x 27 mm
21.5 cm

BK-8982
110 x 20 mm
22 cm

BK-8983
110 x 30 mm
22 cm

BK-8984
110 x 36 mm
22.5 cm



V₂

KRISTELLER
BK-9030 - BK-9032
Üst bleyd/Upper blades
20.5 cm



BK-9030
80 x 28 mm



BK-9031
85 x 35 mm



BK-9032
85 x 40 mm



JACKSON
BK-9040 - BK-9042
Alt bleyd/Lower blades



BK-9040
76 x 38 mm



BK-9041
89 x 38 mm



BK-9042
110 x 38 mm



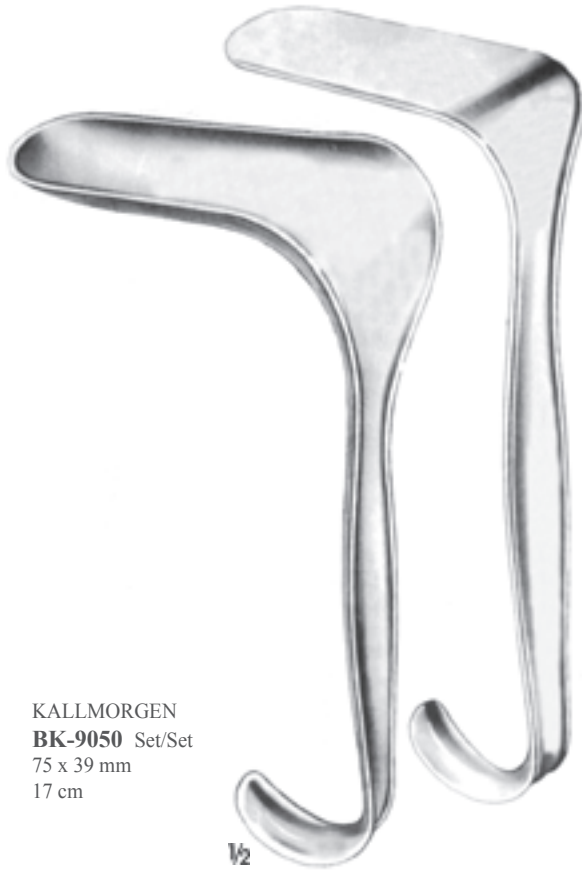

KALLMORGEN
BK-9050 Set/Set
75 x 39 mm
17 cm

1/2



KALLMORGEN
BK-9055 Set/Set
95 x 39 mm
20 cm

1/2

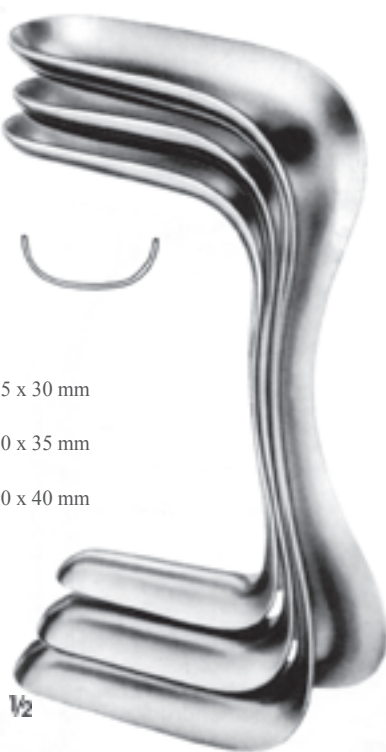

SIMS
BK-9070 70 x 26 / 75 x 30 mm
12.5 cm
BK-9075 75 x 30 / 80 x 35 mm
15 cm
BK-9080 80 x 36 / 90 x 40 mm
17.5 cm

1/2



BREISKY
BK-9060 72 x 25 / 77 x 30 mm
14 cm
BK-9065 75 x 30 / 92 x 38 mm
17 cm

1/2

BK-9100
110 x 20 mm



BK-9101
110 x 30 mm



BK-9102
110 x 36 mm



BK-9100 - BK-9102
Alt bleyd/Lower blade
21.5 cm

BK-9110
115 x 18 mm



BK-9111
115 x 26 mm



BK-9112
115 x 32 mm



KRISTELLER
BK-9110 - BK-9112
Üst bleyd/Upper blade
22 cm

KRISTELLER
BK-9090 110 x 20 mm
BK-9091 110 x 30 mm
BK-9092 110 x 36 mm
Viyana model set
Vienna patterns sets





1/2

**BRAUN
BK-9130**
56 x 13 mm
18 cm



1/2

**BRAUN
BK-9131**
60 x 10 mm
18 cm



1/2

**HEANEY
BK-9025**
89 x 29 mm
17 cm



1/2

**EASTMAN
BK-9035**
89 x 38 mm
17.5 cm



1/2

**LANDON
BK-9140**
89 x 25 mm
19.5 cm



1/2

**MATHIEU
BK-9120**
İç bleyd/İnner blade
95 x 17 - 30 mm
21 cm



1/2

**MATHIEU
BK-9121**
Üst bleyd/Upper blade
95 x 17 - 26 mm
(İç bleyd/İnner blade BK-9120)
21 cm

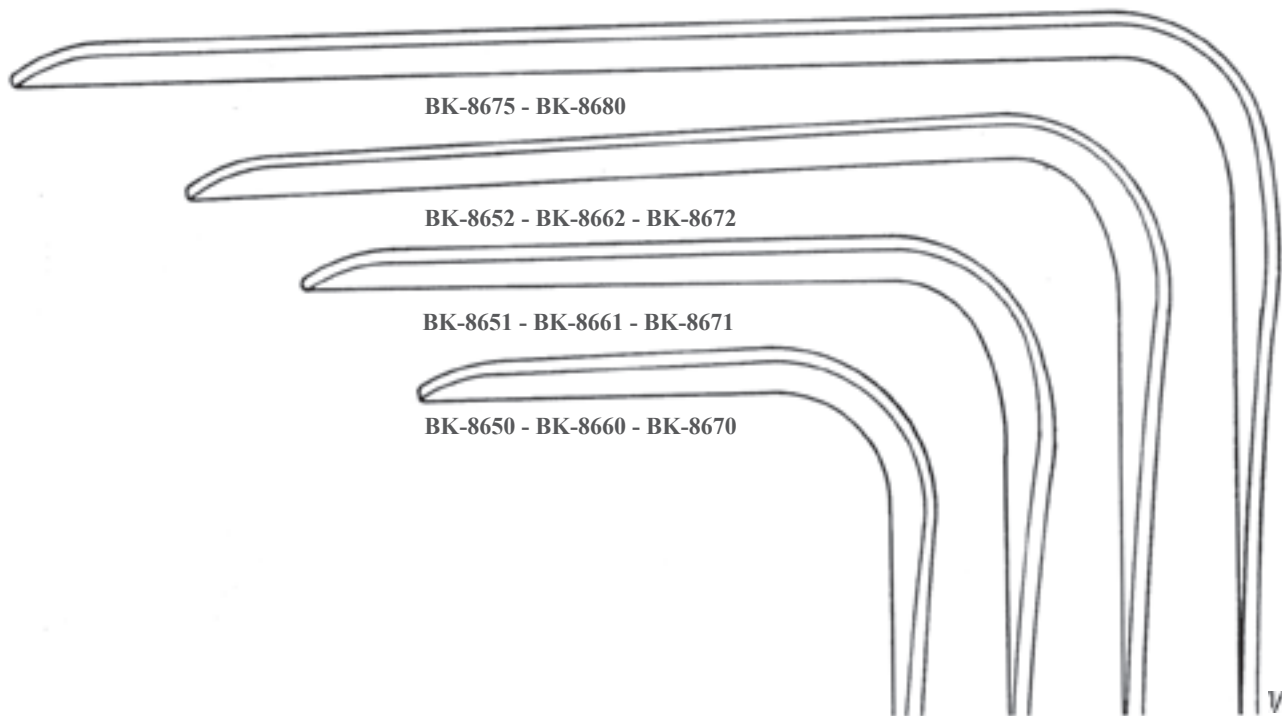

DOYEN
BK-8650 - BK-8680
24 cm

Ağız uzunlukları
Length of blades

60 mm
90 mm
120 mm
160 mm

Ağız genişlikleri
Widh of blades

	35 mm	45 mm	60 mm
60 mm	BK-8650	BK-8660	BK-8670
90 mm	BK-8651	BK-8661	BK-8671
120 mm	BK-8652	BK-8662	BK-8672
160 mm	-	BK-8675	BK-8680





LANDAU
BK-8560 100 x 28 mm
BK-8565 110 x 38 mm
29 cm

1/2



BREISKY
BK-8570 100 x 20 mm
BK-8571 100 x 25 mm
BK-8572 100 x 30 mm
BK-8573 100 x 35 mm
BK-8574 100 x 40 mm
Viyana Model
Vienna patterns
30 cm

1/2



BREISKY
BK-8575 130 x 20 mm
BK-8576 130 x 25 mm
BK-8577 130 x 30 mm
BK-8578 130 x 35 mm
BK-8579 130 x 40 mm
Viyana Model
Vienna patterns
32 cm

1/2

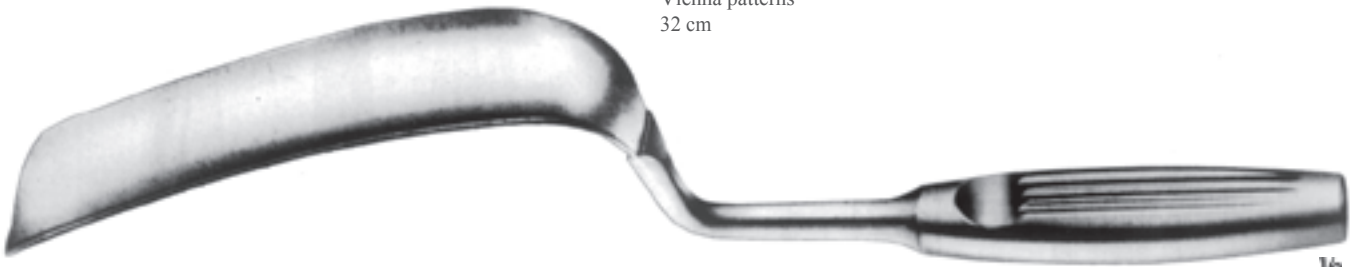

BREISKY
BK-8580 160 x 40 mm
BK-8581 180 x 40 mm
Viyana Model
Vienna patterns
35 cm

1/2





**TÜBINGER
BK-8320**
95 x 20 mm
26.5 cm

BK-8325
105 x 27 mm
25 cm

**SIMON
BK-8330**
115 x 22 mm
27.5 cm

**SIMON
BK-8335**
115 x 26 mm
27.5 cm



1/2

DOYEN
BK-8690 - BK-8692
23.5 cm



BK-8692
112 x 45 mm



BK-8691
90 x 45 mm

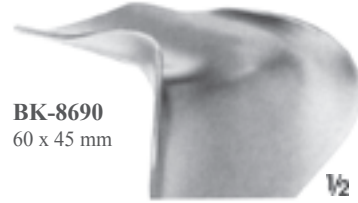

BK-8690
60 x 45 mm

1/2



60 x 30 mm

1/2

DOYEN
BK-9150
Yanal spekulum
Lateral speculum
23 cm



80 x 30 mm

1/2

DOYEN
BK-9151
Yanal spekulum
Lateral speculum
25 cm





WEISSBARTH
BK-9700 80 x 28 mm
BK-9701 85 x 42 mm
21 cm
BK-9702
Sökülebilir süzgeçli
Removable strainer only



AUVARD
BK-9500
65 x 38-28 mm
1.530 gr.
Sökülebilir ağırlıklı
Wiht detachable weight
23 cm



AUVARD
BK-9300 75 x 42-40 mm
BK-9400 105 x 43-40 mm
1.470 gr. sökülebilir ağırlıklı
With detachable weight
23 cm



AUVARD
BK-9200
65 x 38-28 mm
1.530 gr.
Sabit ağırlık
Fixed weight
23 cm





BK-8810
80 x 30 mm

BK-8811
85 x 35 mm

BK-8812
85 x 40 mm

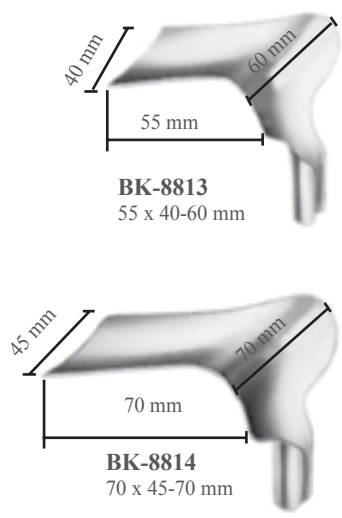

40 mm
55 mm
60 mm
BK-8813
55 x 40-60 mm

45 mm
70 mm
70 mm
BK-8814
70 x 45-70 mm

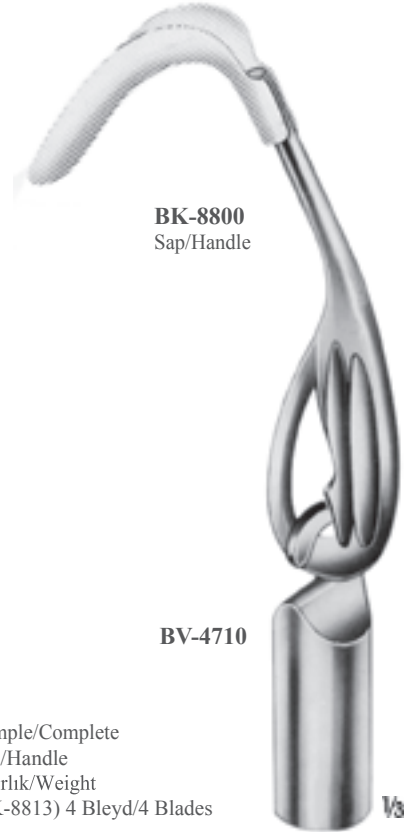

BK-8800
Sap/Handle

BV-4710

(BK-8810 - BK-8814 ve BK-8820 - BK-8827) birbirleriyle deđiřtirilebilir.
(BK-8801 - BK-8802) saplarına olduđu gibi (BK-8800)'yada uyar.
The mentioned blades (BK-8810 - BK-8814 and BK-8820 - BK-8827)
can be exchanged. They fit handle BK-8800 as well as handles
BK-8801 and BK-8802

SCHERBACK

BV-4720 Komple/Complete
(BK-8800) Sap/Handle
(BV-4710) Ađrrlık/Weight
(BK-8810 - BK-8813) 4 Bleyd/4 Blades



BK-8824
80 x 30 mm

BK-8825
85 x 33 mm

BK-8826
100 x 38 mm

BK-8827
110 x 42 mm

BK-8820
65 x 30 mm

BK-8821
75 x 35 mm

BK-8822
85 x 35 mm

BK-8823
95 x 35 mm



BK-8801
23 cm

BK-8802
22 cm

BOZEMANN

BK-8828 Set/Set
(BK-8801 - BK-8802) 2 Sap/2 Handles
(BK-8820 - BK-8827) 8 Bleyd/8 Blades



GELPI
BM-1885
13.5 cm



GELPI
BM-1890
17.5 cm



RICHTER
BM-1895
17 cm



JOLL (FRIEDMANN)
BM-1898
15.5 cm





HEGAR
BJ-9001 - BJ-9117
Sivri uçlu dilatörler
With very conical point
18.5 cm

BJ-9001	1 mm	BJ-9014	14 mm	BJ-9101	1.5 mm	BJ-9114	14.5 mm
BJ-9002	2 mm	BJ-9015	15 mm	BJ-9102	2.5 mm	BJ-9115	15.5 mm
BJ-9003	3 mm	BJ-9016	16 mm	BJ-9103	3.5 mm	BJ-9116	16.5 mm
BJ-9004	4 mm	BJ-9017	17 mm	BJ-9104	4.5 mm	BJ-9117	17.5 mm
BJ-9005	5 mm	BJ-9018	18 mm	BJ-9105	5.5 mm		
BJ-9006	6 mm	BJ-9019	19 mm	BJ-9106	6.5 mm		
BJ-9007	7 mm	BJ-9020	20 mm	BJ-9107	7.5 mm		
BJ-9008	8 mm	BJ-9021	21 mm	BJ-9108	8.5 mm		
BJ-9009	9 mm	BJ-9022	22 mm	BJ-9109	9.5 mm		
BJ-9010	10 mm	BJ-9023	23 mm	BJ-9110	10.5 mm		
BJ-9011	11 mm	BJ-9024	24 mm	BJ-9111	11.5 mm		
BJ-9012	12 mm	BJ-9025	25 mm	BJ-9112	12.5 mm		
BJ-9013	13 mm	BJ-9026	26 mm	BJ-9113	13.5 mm		



HEGAR
BJ-9201 - BJ-9209
19.5 cm

BJ-9201	1 + 2 mm
BJ-9202	3 + 4 mm
BJ-9203	5 + 6 mm
BJ-9204	7 + 8 mm
BJ-9205	9 + 10 mm
BJ-9206	11 + 12 mm
BJ-9207	13 + 14 mm
BJ-9208	15 + 16 mm
BJ-9209	17 + 18 mm



PRATT
BJ-9301 - BJ-9308
29 cm

BJ-9301	13 - 15 Charr.
BJ-9302	17 - 19 Charr.
BJ-9303	21 - 23 Charr.
BJ-9304	25 - 27 Charr.
BJ-9305	29 - 31 Charr.
BJ-9306	33 - 35 Charr.
BJ-9307	37 - 39 Charr.
BJ-9308	41 - 43 Charr.

BJ-9500

Set (BJ-9004 - BJ-9017) 14 parça
Set (BJ-9004 - BJ-9017) 14 piece
CN-7500 1 adet, CN-3752 1 adet, CN-2600 15 adet,
CN-2602 1 adet, CN-2604 2 adet dahildir.
With CN-7500 1 each, CN-3752 1 each,
CN-2600 each, CN-2602 1 each,
CN-2604 2 each.

BJ-9600

Set (BJ-9104 - BJ-9117) 14 parça
Set (BJ-9104 - BJ-9117) 14 piece
CN-7500 1 adet, CN-3752 1 adet, CN-2600 15 adet,
CN-2602 1 adet, CN-2604 2 adet dahildir.
With CN-7500 1 each, CN-3752 1 each, CN-2600
each, CN-2602 each, CN-2604 each.

BJ-9700

Tam set 28 parça/Full set 28 piece
Set (BJ-9004 - BJ-9017)+(BJ-9104 - BJ-9117)
CN-7010 1 adet, CN-3741 1 adet, CN-2600 31 adet,
CN-2602 1 adet, CN-2605 2 adet dahildir.
With CN-7010 1 each, CN-3741 1 each
CN-2600 31 each, CN-2602 1 each, CN-2605 2 each.

CN-2601 230 mm

CN-2602 470 mm

CN-2600 bölücü için sürgülü
ray, güvenlik vidaları ile
Sliding rails with securing
screws, for divider CN-2600

CN-2604 230 mm

CN-2605 470 mm

Sınırlayıcı kalıp, güvenlik vidaları
ile özellikle depolama dilatörü
için uygun
Limiting bars with securing
screws, particularly usefel for
storing dilators

CN-2600

Bölücü, CN-2601 için
Divider, to be used with CN-2601





Tel sepetler/Wire baskets



- CN-3752** 242 x 252 x 40 mm
- CN-3753** 242 x 252 x 60 mm
- CN-3754** 242 x 252 x 80 mm
- CN-3755** 242 x 252 x 110 mm

Tel sepetler/Wire baskets



- CN-3740** 539 x 252 x 40 mm
- CN-3741** 539 x 252 x 60 mm
- CN-3742** 539 x 252 x 80 mm
- CN-3743** 539 x 252 x 110 mm

Tel taban/Wire Base



CN-2482 258 x 258 x 30 mm

Tel taban/Wire Base



CN-2483 545 x 255 x 30 mm





KOGAN
BV-2670
Kilitsiz/Without ratchet
24 cm

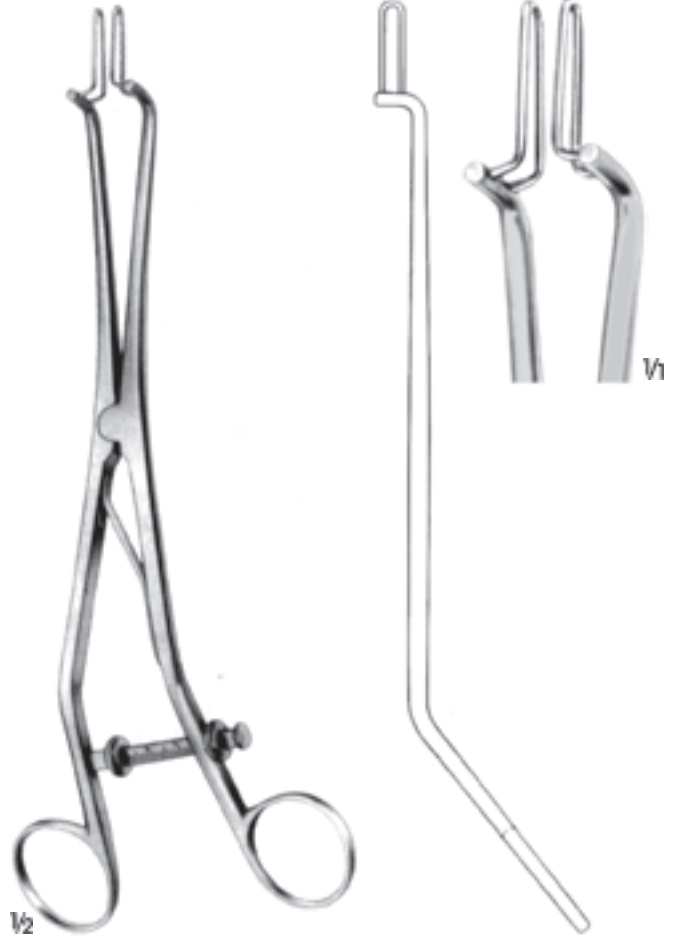

KOGAN
BV-2675
Ölçülü sabitleyici ayar vidası
With scale-ratchet and fixing screw
24 cm





Ø 5 mm



1/2

MAYO
BJ-8906
Bükülebilir/Malleable
33 cm

Ø 4 mm



1/2

SIMS
BJ-8907 33 cm

BJ-8908 33 cm
Bükülebilir/Malleable

Ø 3 mm



1/2

BJ-8909
30 cm

Ø 4 mm



1/2

SIMPSON
BJ-8911
Bükülebilir, gümüş kaplama
Malleable, silver-plated
31 cm

Ø 3.6 mm



1/2

**GALABINS
BJ-8910**
Ölçülü mil, bükülebilir
Shaft graduated in cm, malleable
29.5 cm

Ø 4 mm



1/2

**VALLEIX
BJ-8912**
Ölçü kaydırıcı, göstergeli
Graduated, with slider
25 cm

24 mm



1/2

**BRAUN
BK-3070**
Uterin bastırıcı
Uterine depressor
27 cm





BE-3600
düz/straight

PELKMANN
BE-3600 - BE-3601
26 cm



BE-3601
eğri/curved



BOZEMANN
BE-3610
25 cm



BOZEMANN
BE-3611
Ağız oluklu pens
Jaws with longitudinal
groove
25.5 cm



BOZEMANN
BE-3612 - BE-3613

BE-3612
26 cm



BE-3613
25 cm



BOZEMANN-DOUGLAS
BE-3614
26 cm





**BERNHARD
BE-4104**
16 cm



**POZZI
BE-4105**
17.5 cm



**ADAIR
BE-4103**
19 cm



**BRAUN
BE-3104**
Narin Model/Slender pattern
25 cm



**COLLIN-POZZI
BE-3108**
25 cm



**WILSON
BE-3101**
24 cm



**SCHRÖDER
BE-3100**
Standart Model
Standard pattern
25 cm

**SCHRÖDER
BE-3102**
25 cm

**POZZI
BE-3103**
Zorlu operasyon için
Heavy pattern
25.5 cm



DUBLAY
BE-3107
25 cm

BE-3105
26.5 cm

ABEL
BE-3106
28 cm



MUSEUX
BE-3620
20 cm



JACOBS
BE-3621
21.5 cm



MUSEUX
BE-3650 - BE-3652
24 cm



MUSEUX
BE-3653 - BE-3654
26.5 cm





LITTLEWOOD
BE-3625
18.5 cm



TEALE
BE-3630
22.5 cm



MUSEUX
BE-3655 - BE-3656
Yana eğri
Curved to side
24 cm



KÜSTNER
BE-3660
25 cm

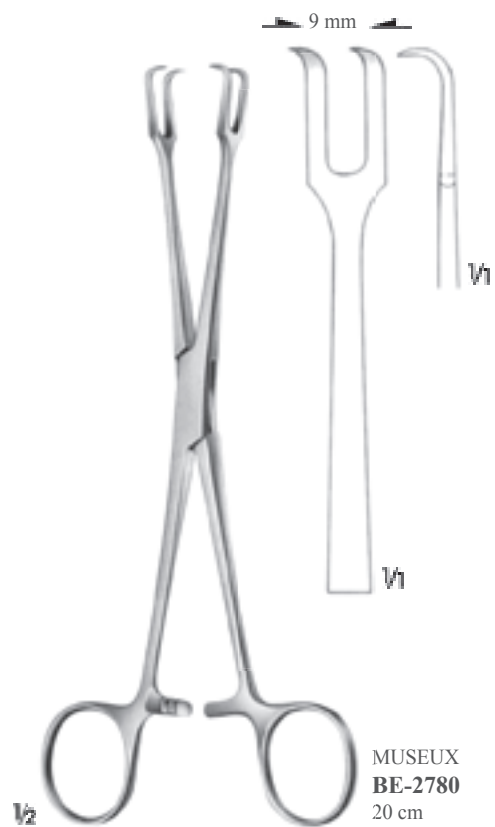
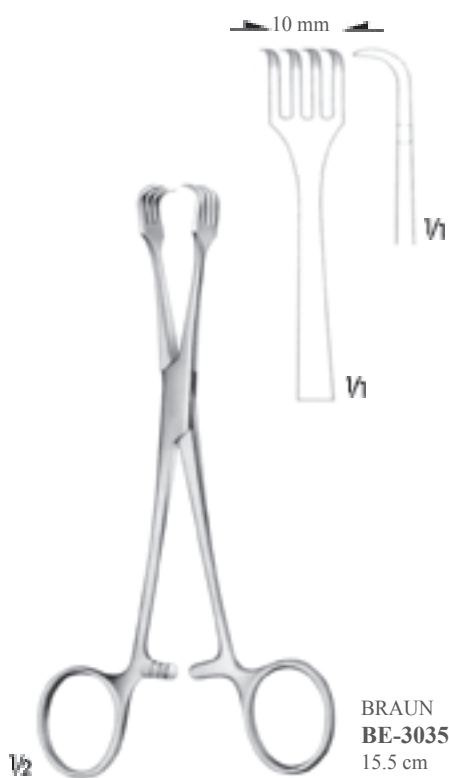
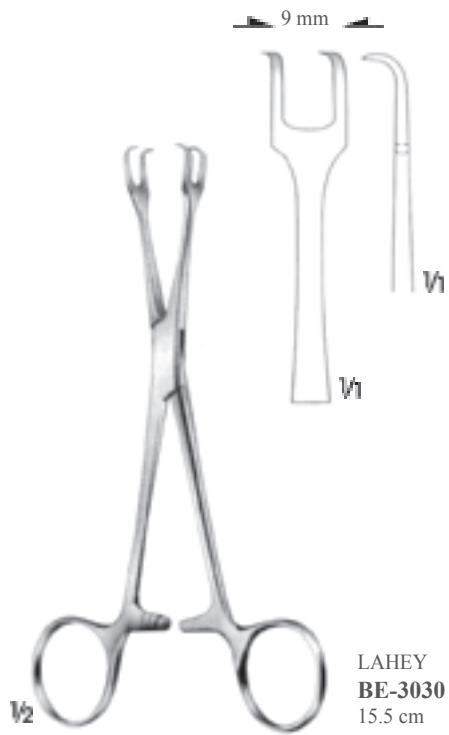

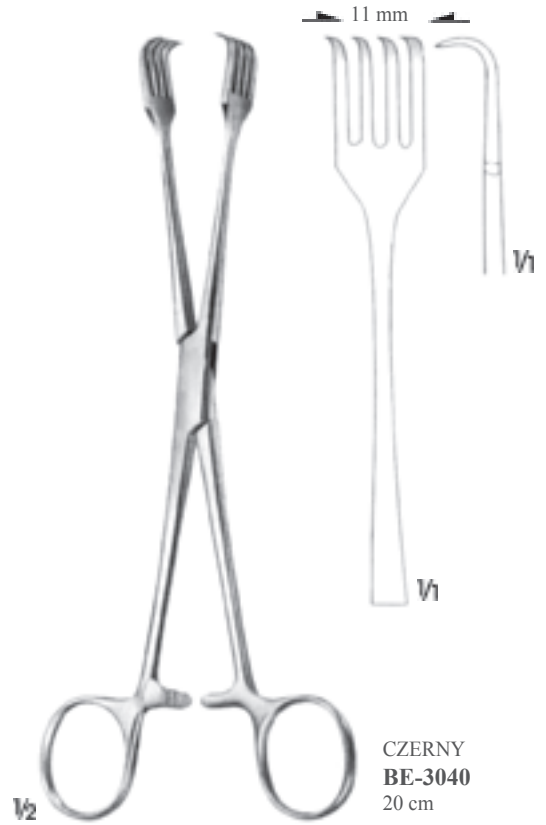
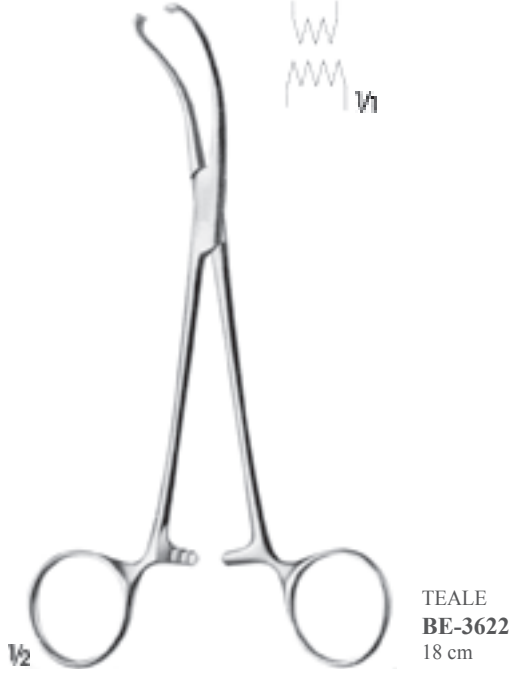

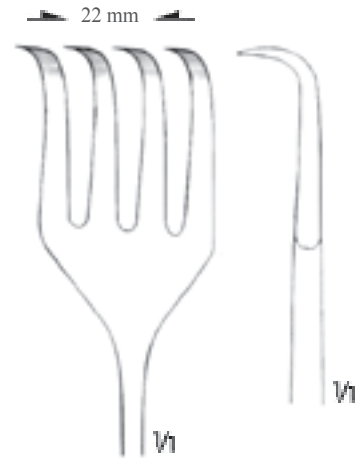
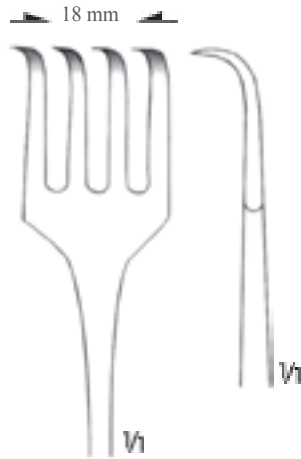



HEYWOOD-SMITH
BE-3020
25 cm



NOTO
BE-2640
28 cm



KELLY
BE-2650
32 cm



V1



V1

Atromatik
Atraumatic

21 mm 27 mm



BE-2660



BE-2661



V2

HEYWOOD-SMITH
BE-2911
20 cm



V2

DOYEN
BE-3015
18.5 cm



BE-2660 25 cm
BE-2661 27 cm





SOMER
BE-4800
23.5 cm



DARTIGUES
BE-4809
25.5 cm



COLLIN
BE-4603
26.5 cm



BONNEY
BE-2610
24 cm



COLLIN
BE-4805
25 cm



COLLIN
BE-4810
28.5 cm





BB-1120

Açılı bistüri sapı
Scalpel handle, angular curved
22.5 cm



DOYEN

BV-2715

Myoma burgusu
Myoma screw
15 cm



DOYEN

BV-2719

Myoma burgusu
Myoma screw
19 cm



BG-5200
23.5 cm



BG-5201
35 cm



KEIBACK
BG-5200 23.5 cm
BG-5201 35 cm
Yan kavisli üretral tünel pensleri
Urethral tunnel clamps, curved to side



UCHIDA
BV-2727 27 cm
BV-2735 35 cm
Kaşıklar/Spoons





KIEBACK
BC-5417 - BC-5418
Parametrium makaslar
Parametrium scissors

BC-5417
24 cm

BC-5418
35 cm

KEIBACK
BC-5419 - BC-5420
Parametrium makaslar
1 bleydi küre uçlu, yana eğri
Parametrium scissors, curved to side,
with 1 probe pointed blade

BC-5419
26 cm

BC-5420
35 cm



BURKE
BG-6700 - BG-6701
Parametrium pensler, kısa ağızlı
Parametrium clamps, short jaw part



BURKE
BG-6702 - BG-6703
Parametrium pensler, uzun ağızlı
Parametrium clamps, long jaw part





Bükülebilir
Malleable



**ASCH
BP-7740**
Kaşık/Scoop
20 cm



**RANDALL
BP-7730**
Biyopsi küreti
Biopsy curette
24 cm



**NOVAK-SCHOECKAERT
BP-7750**
Biyopsi küreti
Biopsy curette
24 cm



**BERLIN
BP-7780**
Biyopsi küreti
Biopsy curette
27 cm



**MÜNCHEN
BP-7785**
Biyopsi küreti
Biopsy curette
27 cm



**SAUNDERS
BP-7790**
Çıkarma huk
Removing hook
32 cm

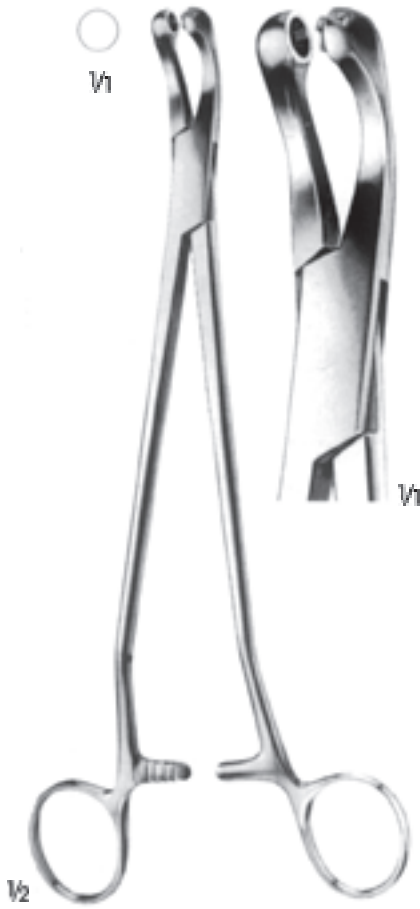

THOMS-GAYLOR
BS-5600
24 cm



SCHUBERT
BS-5605
26 cm



FAURE
BS-5610
21 cm



FAURE
BS-5611
24 cm





Çengel ağız ile daha güvenilir tutuş sağlar.
Ağız geniş açılabilir.
Düzgün ve uygun kesme sağlar.
Deforme olmamış ezilmemiş parça alınmasına imkan verir.
Travma'ya neden olmaması nedeni ile iyileşme çabuk olur.

More reliable grip on the tissue due to 'hooking' effect.
Wide angle of opening.
Smooth, steady cut.
Specimens are not squashed.
Not painful; self-wound, heals well.



BS-5620



BS-5621



BS-5630
2 mm

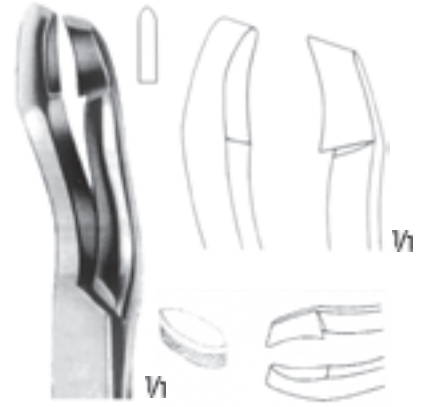

BS-5631
2.4 mm

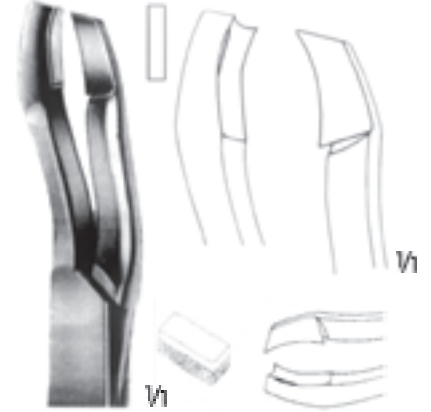

BS-5640
2.4 mm



1/2

SCHUMACHER
BS-5620 - BS-5621
24 cm



1/2

SEIDL DBP
BS-5630 - BS-5640
Bayonet biyopsi pensleri
Bayonet-Shaped biopsy forceps
24 cm



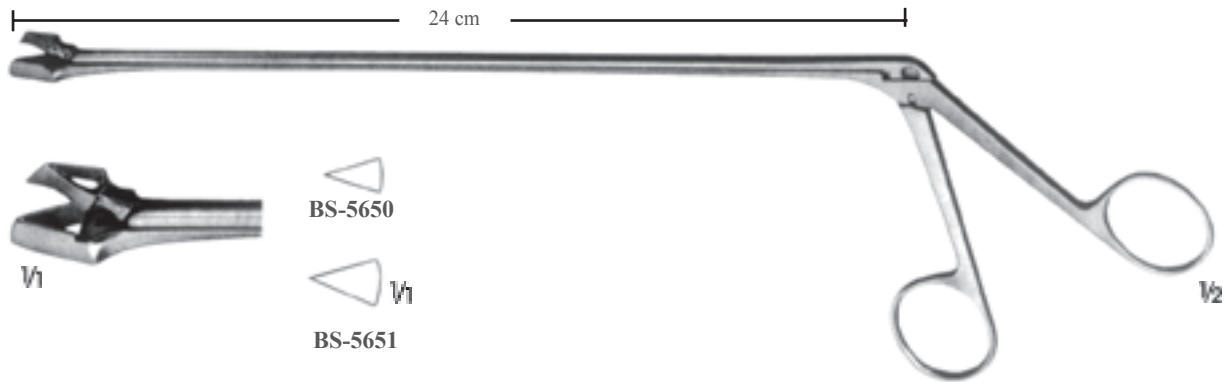

SCHUMACHER
BS-5650 - BS-5651
Kolposkopi için uygun
Suitable for colposcopy
24 cm



EPPENDORF
BS-5660
Kolposkopi için uygun
Suitable for colposcopy
20 cm

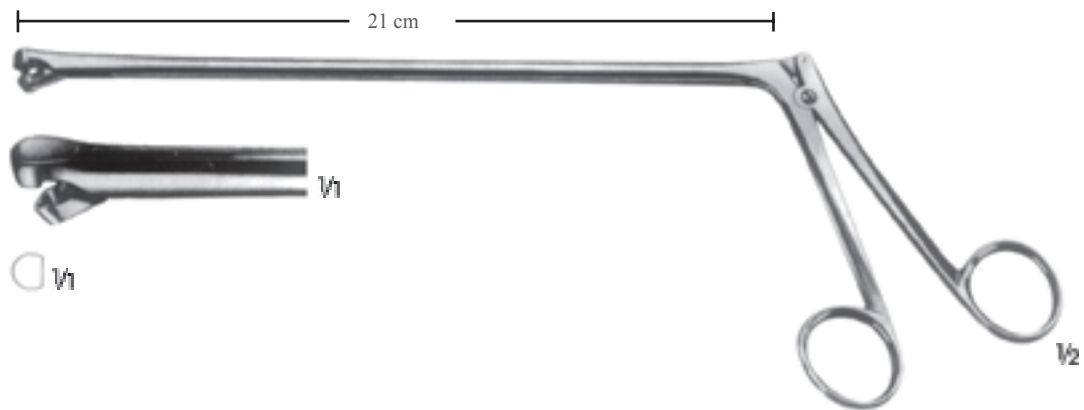

BERGER
BS-5680
21 cm



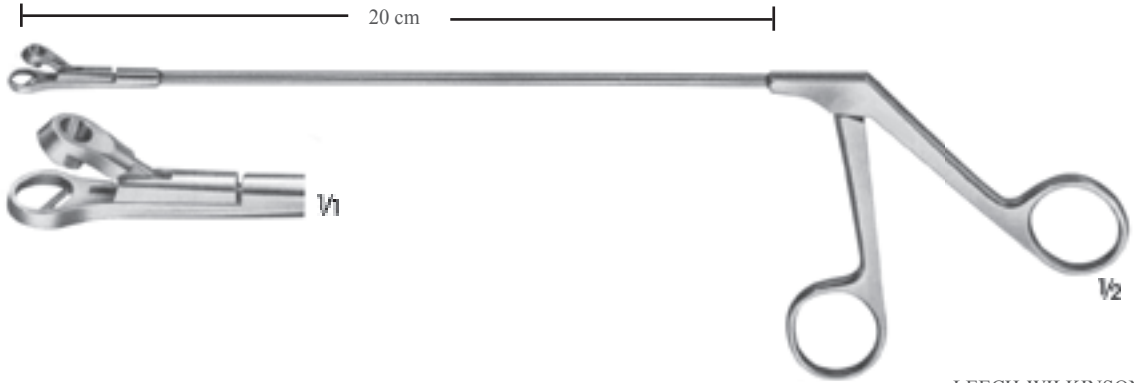

LEECH-WILKINSON
BS-5670

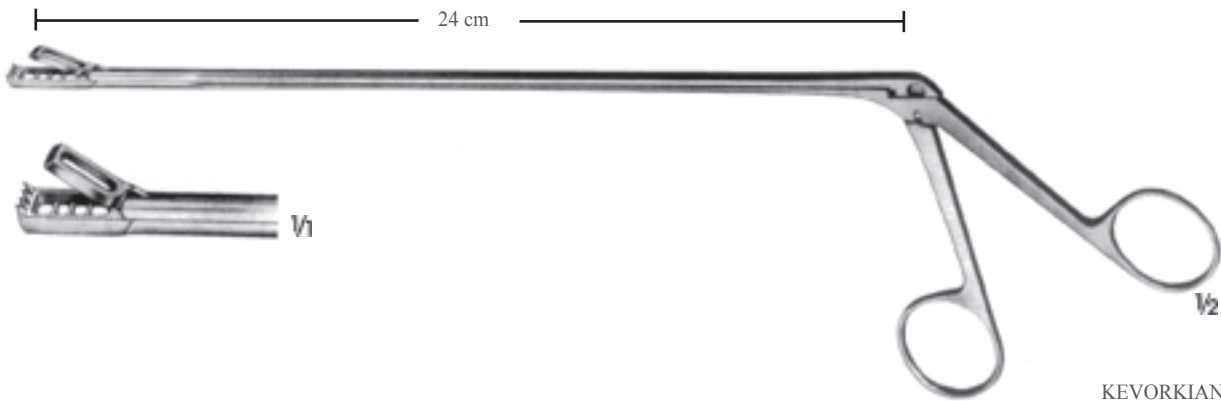

KEVORKIAN
BS-5690
24 cm

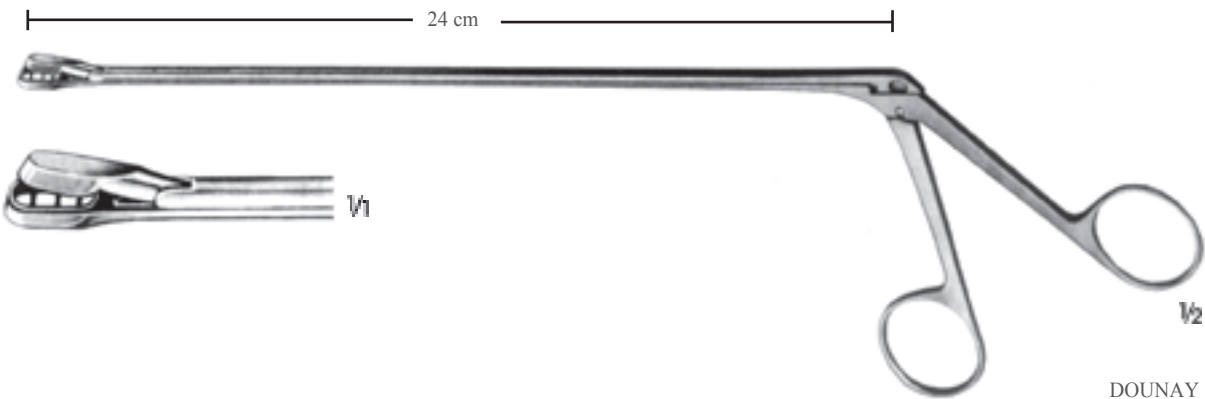

DOUNAY
BS-5700
24 cm

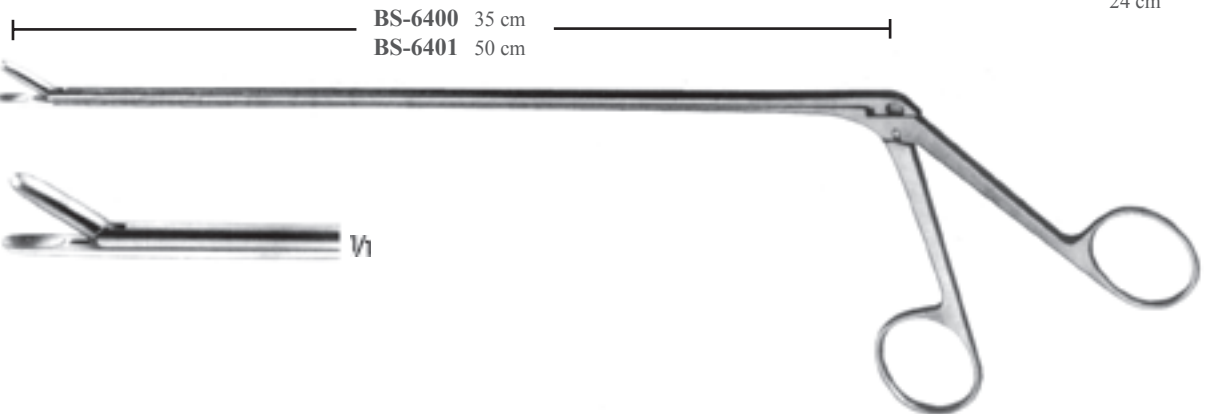

BS-6400 - BS-6401

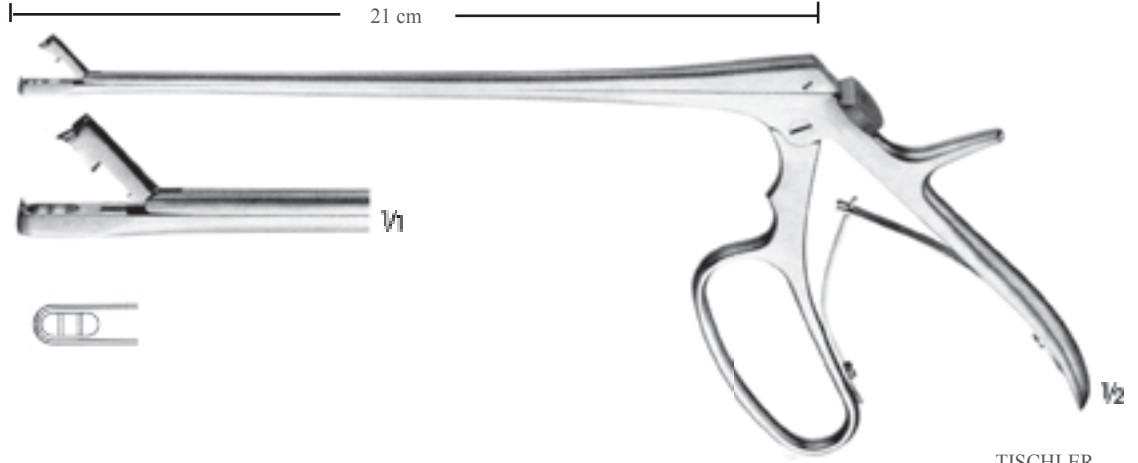

TISCHLER
BS-5720

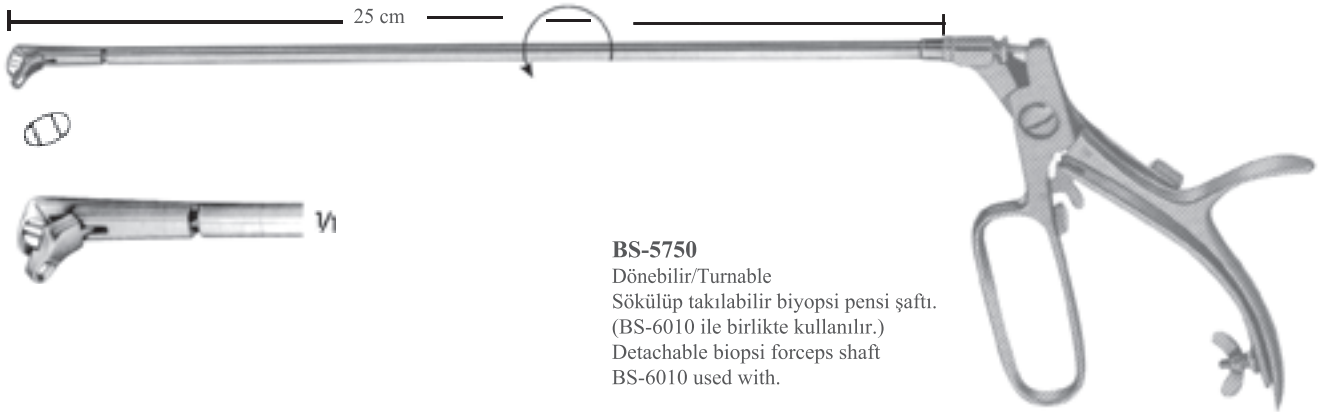

BS-5750
Dönebilir/Turnable
Sökülüp takılabilir biyopsi pensi shaftı.
(BS-6010 ile birlikte kullanılır.)
Detachable biopsy forceps shaft
BS-6010 used with.



BS-6010
Universal sap
Universal handle
14 cm



HUBER
BS-6020
Universal sap
Universal handle
14 cm



BRÜNNINGS
BS-5760 20 cm
BS-5761 25 cm
Uzatma kanülü/Extension cannula



BS-5780



BS-5781



KRAUSE
BS-5780 - BS-5781
Biyopsi uçları/Biopsy tips



SCHUMACHER
BS-5820
Biyopsi ucu/Biopsy tip



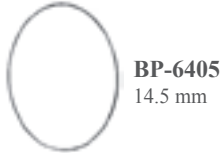

BP-6405
14.5 mm

Fig. 6



BP-6505
14.5 mm

Fig. 6



14 mm

BP-6604



BP-6404
13 mm

Fig. 5



BP-6504
13 mm

Fig. 5

12 mm



BP-6603



BP-6403
11.5 mm

Fig. 4



BP-6503
11.5 mm

Fig. 4

10 mm



BP-6602



BP-6402
10 mm

Fig. 3



BP-6502
10 mm

Fig. 3

8 mm



BP-6601



BP-6401
8.5 mm

Fig. 2



BP-6501
8.5 mm

Fig. 2

6 mm



BP-6600



BP-6400
6.8 mm

Fig. 1



BP-6500
6.8 mm

Fig. 1

$\frac{1}{2}$

SIMON
BP-6400 - BP-6405
24 cm

$\frac{1}{2}$

SCHRÖDER
BP-6500 - BP-6505
31 cm

$\frac{1}{2}$

GOURDET
BP-6600 - BP-6604
Künt/Blunt
28 cm



RECAMIER
BP-6704 - BP-6723
 Sivri-Rijid/Sharp-Rigid
BP-6808 - BP-6819
 Sivri-Bükülebilir/Sharp-Malleable
BP-6907 - BP-6923
 Kunt-Rijid/Blunt-Rigid
 30 cm



BP-6721
BP-6921
 21.5 mm

Fig. 9



BP-6718
BP-6818
BP-6918
 18 mm

Fig. 7



BP-6715
BP-6815
BP-6915
 15 mm

Fig. 5



BP-6712
BP-6812
BP-6912
 12 mm

Fig. 3



BP-6708
BP-6808
BP-6908
 8.5 mm

Fig. 1



BP-6704
 4.5 mm

Fig. 00



BP-6723
BP-6923
 23.5 mm

Fig. 10



BP-6719
BP-6819
BP-6919
 19.5 mm

Fig. 8



BP-6716
BP-6816
BP-6916
 16.5 mm

Fig. 6



BP-6714
BP-6814
BP-6914
 14 mm

Fig. 4



BP-6710
BP-6810
BP-6910
 10.5 mm

Fig. 2



BP-6707
BP-6907
 7.5 mm

Fig. 0





BP-7015
BP-7115
BP-7215
15 mm

Fig 6



BP-7328
28.5 mm

Fig 6



BP-7014
BP-7114
BP-7214
14 mm

Fig 5



BP-7323
23.5 mm

Fig 4



BP-7326
26 mm

Fig 5



BP-7012
BP-7112
BP-7212
12 mm

Fig 4



BP-7319
19.5 mm

Fig 2



BP-7321
21.5 mm

Fig 3



BP-7010
BP-7110
BP-7210
10.5 mm

Fig 3



BP-7008
BP-7108
BP-7208
8.5 mm

Fig 2



BP-7007
BP-7107
BP-7207
7.5 mm

Fig 1



BP-7316
16 mm

Fig. 0



BP-7318
18 mm

Fig. 1



SIMS

BP-7007 - BP-7015
Sivri-Rijid/Sharp-Rigid
BP-7107 - BP-7115
Sivri-Bükülebilir/Sharp-Malleable
BP-7207 - BP-7215
Künt-Rijid/Blunt-Rigid
25.5 cm

BUMM

BP-7316 - BP-7328
Künt-Bükülebilir/Blunt-Malleable
29 cm



RECAMIER
BP-7400 - BP-7401
Künt-Rijid/Blunt-Rigid
36 cm



Fig.2

BP-7401
39.5 mm



Fig. 1

BP-7400
34.5 mm



Fig.3

BP-7501
BP-7504
28.5 mm



Fig. 2

BP-7503
26 mm



Fig. 1

BP-7500
BP-7502
23.5 mm



BUMM
BP-7500 - BP-7501
Sivri-bükülebilir/Sharp-malleable
BP-7502 - BP-7504
Künt-bükülebilir/Blunt-malleable
31 cm





Künt/Blunt

Sivri/Sharp

**BLAKE
BP-7710**
27.5 cm



**HEANEY
BP-7700**
24 cm



**COLLIN
BP-7600**
30 cm

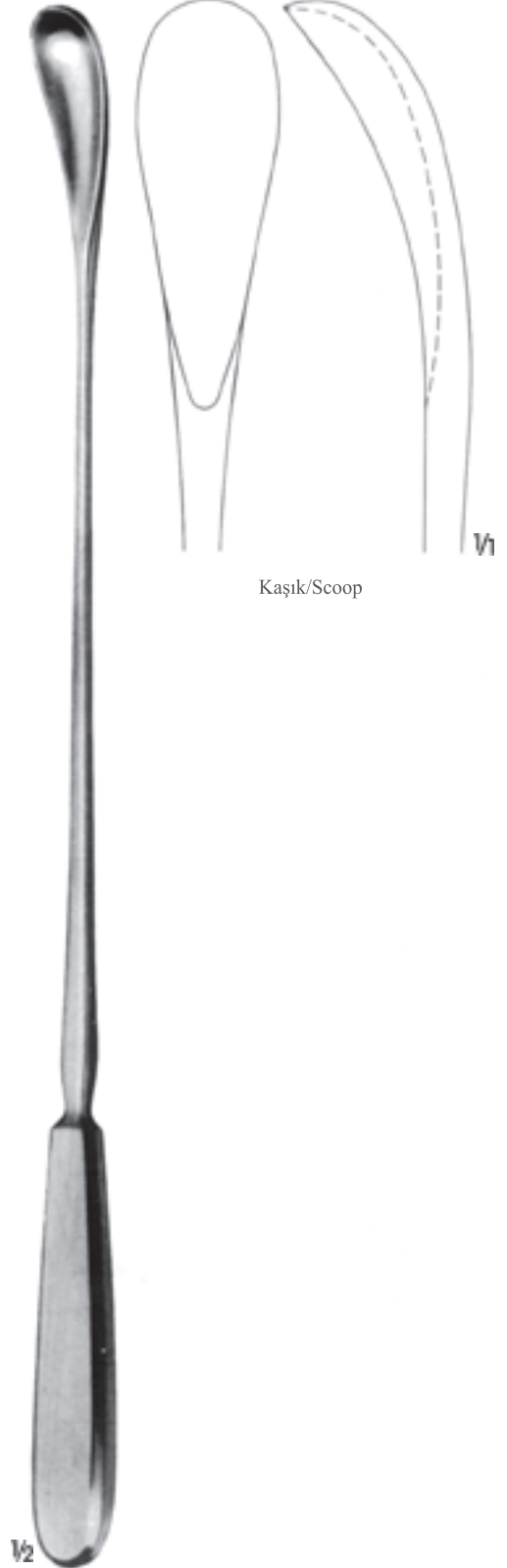

**WALLICH
BP-7720**
42 cm

Kaşık/Scoop

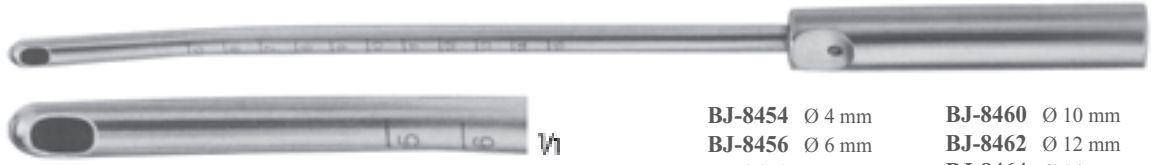

BJ-8454 Ø 4 mm **BJ-8460** Ø 10 mm
BJ-8456 Ø 6 mm **BJ-8462** Ø 12 mm
BJ-8458 Ø 8 mm **BJ-8464** Ø 14 mm

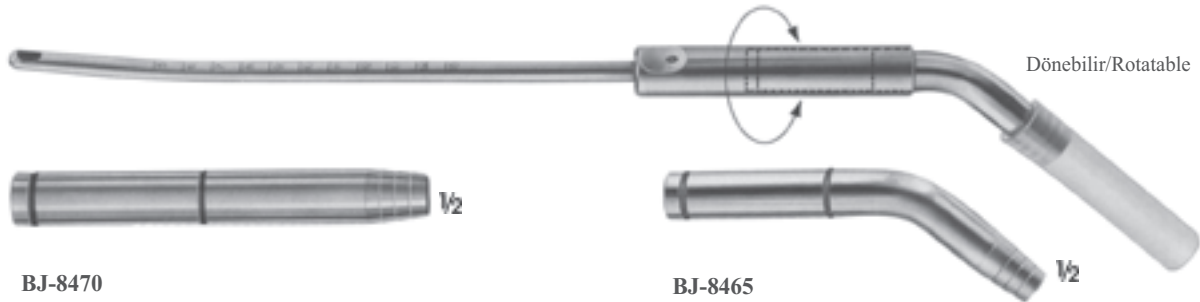

Dönebilir/Rotatable

BJ-8470
Hortum bağlantısı, düz
Hose connection, straight
iç çap Ø 11 mm
inside diam Ø 11mm

BJ-8465
iç çap Ø 11 mm
inside diam Ø 11mm

Çalışması :

Arzu edilen (ihtiyaç duyulan) vakum miktarı ayarlama vidası ile sürekli olarak istenilen değere ayarlanabilir. Vakum oluştuğunda bu vakumun emme kafalarına uygulanması için hızlı-kesme düğmesinin sağa veya sola basılması ile sağlanır. Ayarlanan vakum değeri vakum ayar vidası ile değiştirilebilir. Emme işleminin aniden durdurulması isteniyorsa hızlı-kesme düğmesi kapatılır. Böylece emme kafasına gelen vakum kesilmiş ve emme kavanozuna akış durdurulmuş olur.

Function:

The vacuum required can be constantly preset by the adjusting screw. This vacuum exists then up to the closed quick-shutter, thus the vacuum in the suction head is pressed from the left to the right, the mounted suction head is immediately put under the preset vacuum. In case the preset vacuum has to be changed, this can be done with the adjusting screw. For immediate removal of the suction head simply close the quickshutter, thus the vacuum in the suction head is eliminated at once whereas the vacuum in the suction jar remains unchanged.

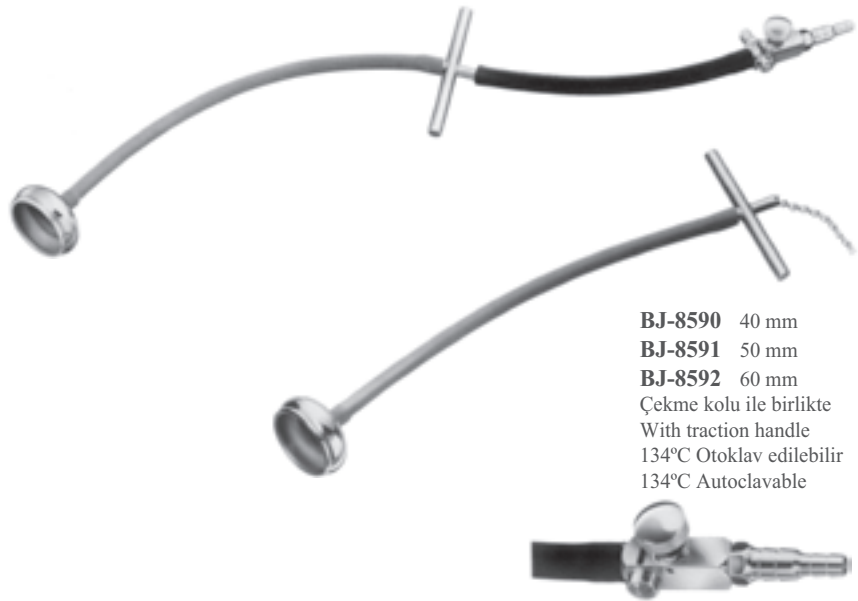

BJ-8590 40 mm
BJ-8591 50 mm
BJ-8592 60 mm
Çekme kolu ile birlikte
With traction handle
134°C Otoklav edilebilir
134°C Autoclavable

BJ-8595
El vanası ve bağlantı borusu
20 cm uzunluğunda bağlantı borusu
Hand valve with connection hose
20 cm long connection hose





SCHULZE
BJ-8604
Uç/Tip



SCHULZE
BJ-8603
Uç/Tip



BJ-8602
Uç/Tip

SCHULZE
BJ-8601
37.5 cm



SCHULZE
BJ-8600 Komple/Complete
BJ-8601
BJ-8602 - BJ-8603 - BJ-8604
Salpingografi için uterin kanül
Salpingography uterine cannula



BJ-8610
Büyük/Large
Ø 16 x 30 mm



BJ-8609
Orta/Medium
Ø 13 x 30 mm



BJ-8608
Küçük/Small
Ø 10 x 25 mm

LEECH-WILKINSON
BJ-8608 - BJ-8610
Uterin kanül
Uterine cannula
26.5 cm



BJ-9800
Rahim kanülü, büyük ve küçük
2 adet değiştirilebilir konik uçları ile
Uterine cannula with spring
connector, self-retaining complete with
2 interchangeable cones large and small
25 cm



**SPACKMAN
BJ-8606**
Ayarlanabilir plaka ile
vulsulum pensi
With adjustable plate for
vulsulum forceps
36 cm



**BEHRMAN
BJ-8607**
Konik ucu çıkartılabilir
uterin kanülü
Uterine cannula with
detachable cone
30.5 cm



**ROTUNDA
BJ-8611**
İrigasyon kanül
Irrigation cannula
20 cm





Özel Set transvajinal paraservikal ve
pupendus anestezi Enjeksiyonu için
Special set for transvaginal injection for
paracervical anestheisa as well as
anestheisa of the pudendus



BJ-3917

Kılavuz kılıfı
Guide sheath
17.5 cm

BJ-2001

Enjeksiyon iğnesi
Injection needle
Luer-lock
1,0 x 18.5 cm



DE LEE

AA-2472

Pelvimetre santimetre ve inç ölçülü
Pelvimeter centimeters and inches
measured



MARTIN

AA-2473

Santimetre ölçülü
Graduated in centimeters



**BEACHAM
BK-2345**
Amniyotom/Amniotome
24 cm



BB-3400
Poş Açıcı/Pouch opener
44 cm



**HERFF
BE-3665**
Zar delici pens
Membrane puncturing forceps
25.5 cm



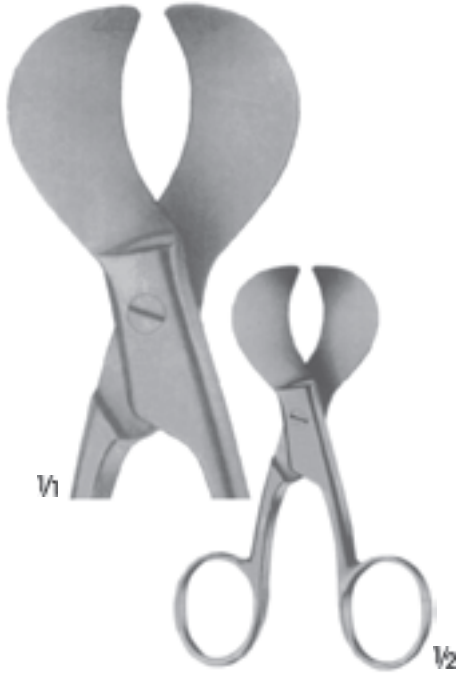

BC-5408
Göbek bağı makası
Umbilical cord scissors
10.5 cm



SCHUMACHER
BC-5409
Göbek bağı makası
Umbilical cord scissors
15.5 cm



BC-5410 - BC-5411
Göbek bağı makasları
Umbilical cord scissors



BC-5410
13.5 cm



BC-5411
16 cm





BRAUN-STADLER
BC-5412 - BC-5413
Epizyotomi makasları
Episiotomy scissors



BC-5412
14.5 cm



BC-5413
20 cm



BC-5414
Epizyotomi makas
Episiotomy scissors
24 cm

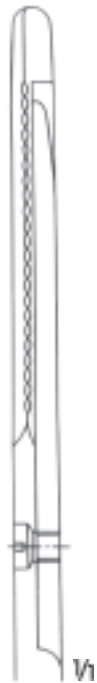

BJ-2850
Göbek dilatörü
Umbilical dilator
9.5 cm



COLLIN
BV-2720
Göbek kordonu klemp
Umbilical cord clamp
8.5 cm





1/3

**SIMPSON
BE-4704**
Sezeryan ameliyatı için
For caesarean section
23.5 cm



1/3

**SIMPSON-BRAUN
BE-4700**
30.5 cm



1/3

**SIMPSON-BRAUN
BE-4701**
35 cm



1/3

**NAGELE
BE-4702**
35.5 cm





1/3

**WRIGLEY
BE-4705**
Sezeryan ameliyatı için
For caesarean section
25 cm



1/3

**SELHEIM
BE-4808**
Obstetrik levye
Obstetric lever
30 cm



1/3

**KIELLAND
BE-4802**
42 cm



1/3

**PIPER
BE-4803**
44.5 cm





**TARNIER
BE-4811**
Çekme çubuklu
With traction rod
40 cm



**BARNES-NEVILLE
BE-4812**
Çekme sapları
With traction handle
43.5 cm



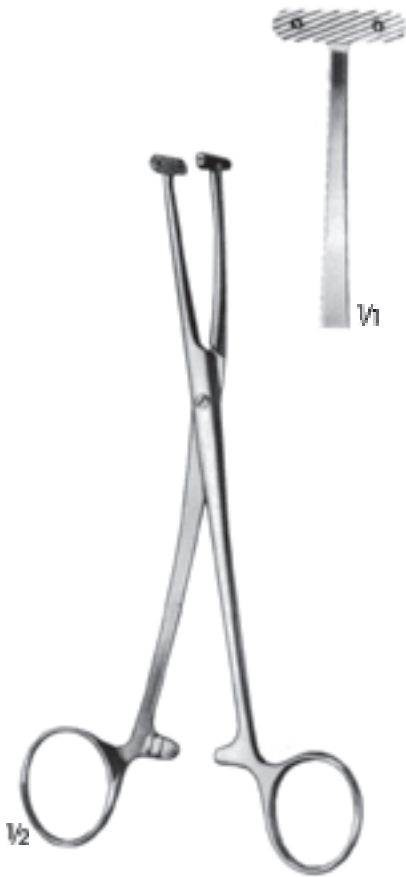

WILLETT
BE-4813
Kafa derisi tutucu pens
Scalp flap forceps
18.5 cm

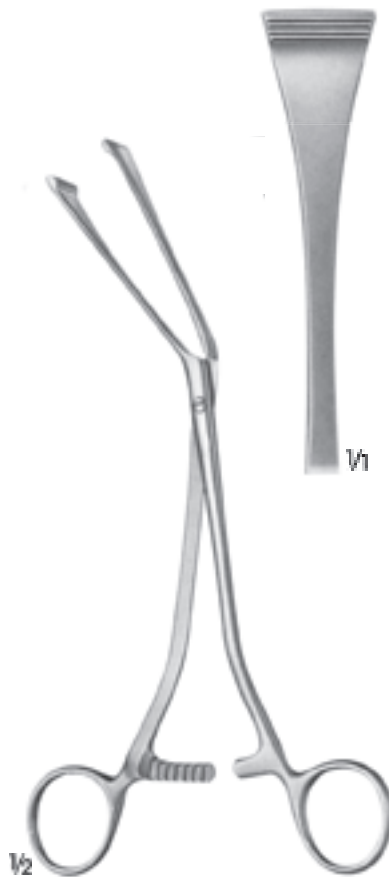

GREEN-ARMYTAGE
BE-4814
Sezeryan hemostatik pens, açılı
Caesarean hemostatic forceps
angled
19.5 cm



GREEN-ARMYTAGE
BE-4815
Sezeryan hemostatik pens düz
Caesarean hemostatic forceps
straight
22 cm





BE-5101 **BE-5102**



BE-5201 **BE-5202** **BE-5203**



BE-5301 **BE-5302**



WINTER
BE-5101 - BE-5102
29 cm



WINTER
BE-5201 - BE-5203
29 cm



WINTER
BE-5301 - BE-5302
Kilitli/With ratchet
29 cm



SAENGER
BE-5401
26.5 cm

SAENGER
BE-5402
27.5 cm

SAENGER
BE-5403
28.5 cm



MC. CLINTOCK
BE-5410
24 cm

BE-5400
28.5 cm

KELLY
BE-2650
32 cm



SMELLIE
BV-2827
27 cm



LEWKOWITZ
BE-5404 - BE-5405
24.5 cm



BOER
BE-5406
29 cm



BE-5404



BE-5405



BE-5406



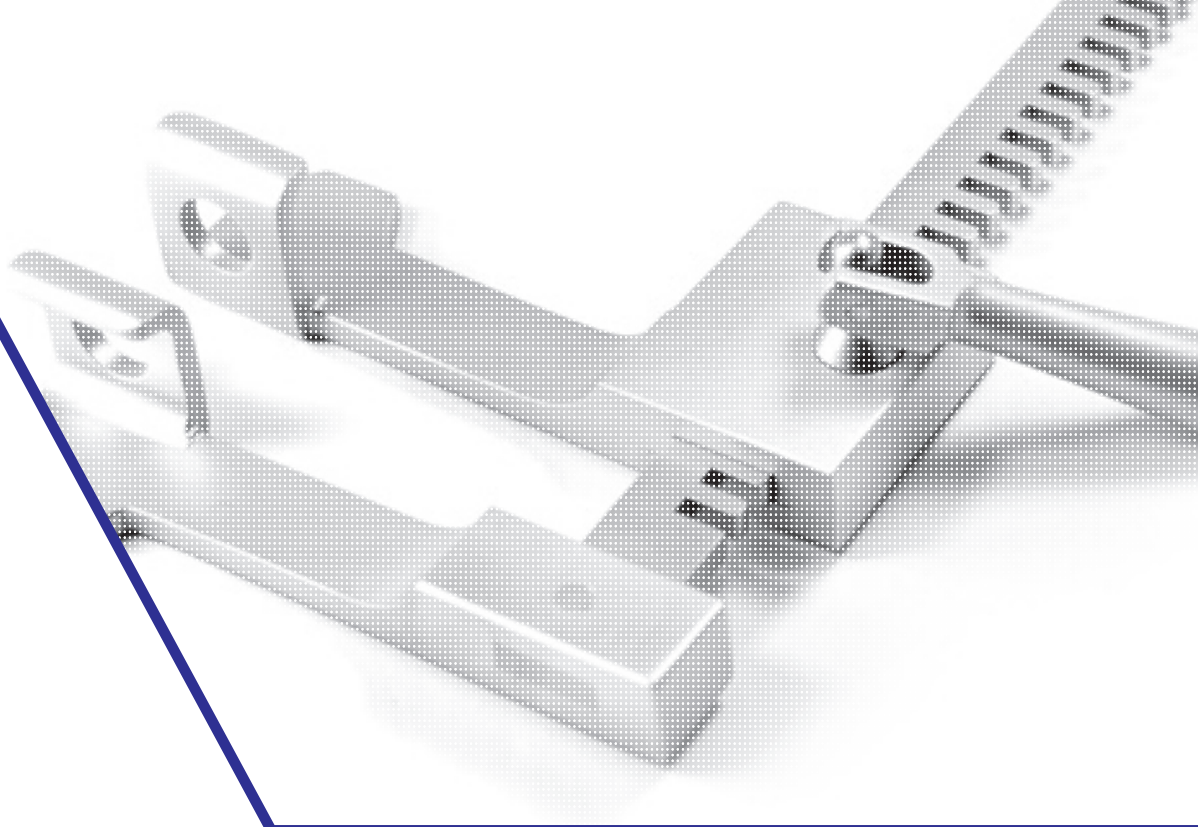

CV

Kalp ve Damar Cerrahi
Cardiovascular and Thoracic Surgery





Küçük(sarı)
Small(yellow)



Orta(mavi)
Medium(blue)



Orta-büyük(yeşil)
Medium-large(green)



Büyük(turuncu)
Large(orange)



Küçük(sarı)
Small(Yellow)



BG-1702 25°
28 cm



BG-1704 65°
28 cm

Orta(mavi)
Medium(blue)



BG-1802 25°
28 cm



BG-1804 65°
28 cm

Orta-büyük(yeşil)
Medium-large(green)



BG-1901 25°
28 cm



BG-1904 65°
28 cm



BG-1906 90°
28 cm

Büyük(turuncu)
Large(orange)



BG-2001 25°
28 cm



BG-2003 65°
28 cm



BG-2005 90°
28 cm



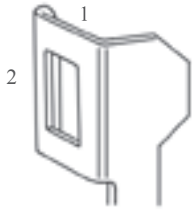

Göğüs ekartörü bleydleri için ölçü sistemi

Derinlik : 1
Genişlik : 2

Örnek: 1 x 2 mm

Measurement system for rib retractor blades

Depth : 1
Width : 2

Example: 1 x 2 mm

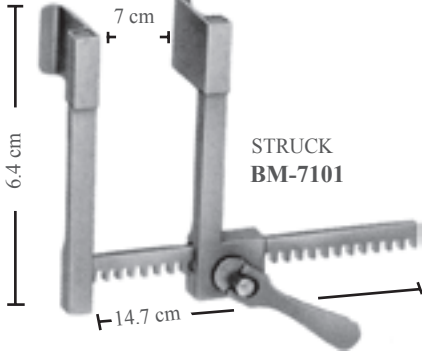

STRUCK
BM-7101

STRUCK
BM-7100 Komple/Complete
BM-7101 Sadece Ekartör/Retractor Only
BM-7102 - BM-7106 Bleydler(çift)/Blades(pairs)

Bleyd(çift)/Blade(pair)

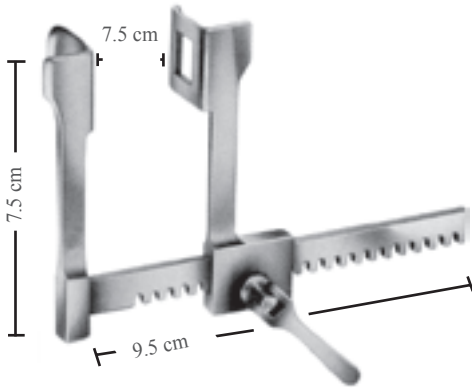

FINOCHIETTO
BM-7200
Bleydler/Blades
18 x 21 mm



STRUCK
BM-7102
Bleydler/Blades
10 x 10 mm



STRUCK
BM-7103
Bleydler/Blades
10 x 15 mm



STRUCK
BM-7104
Bleydler/Blades
10 x 20 mm



STRUCK
BM-7105
Bleydler/Blades
15 x 20 mm



STRUCK
BM-7106
Bleydler/Blades
20 x 20 mm

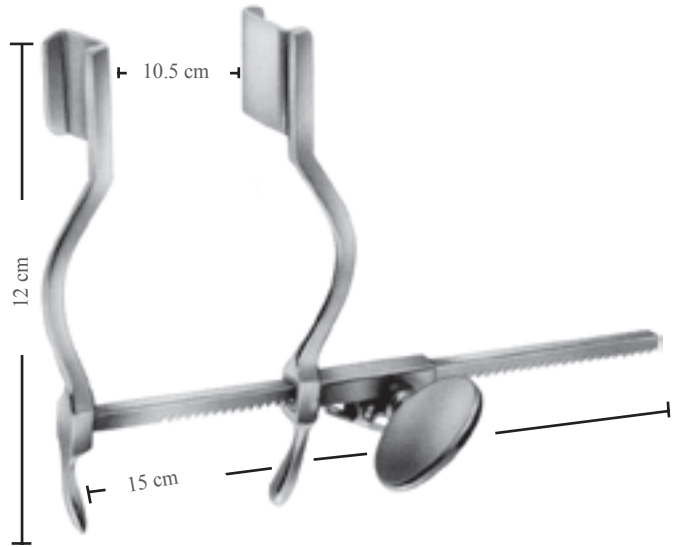

HERTZLER
BM-2675
Bleydler/Blades
20 x 25 mm

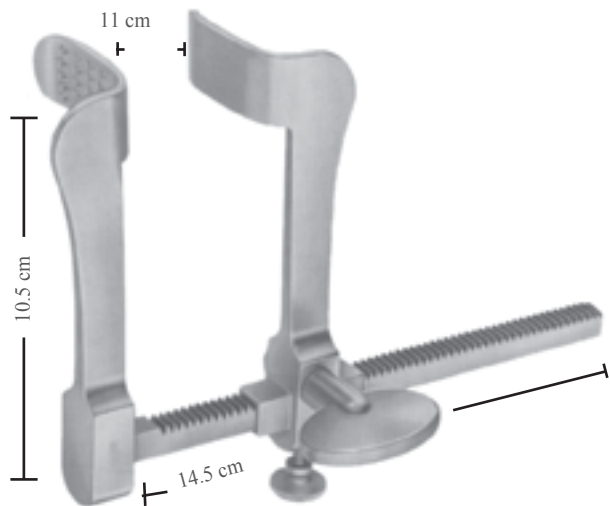

TUFFIER
BM-7300
Bebekler için göğüs ekartörü
Rib retractor for infants
Bleydler/Blades
32 x 19 mm

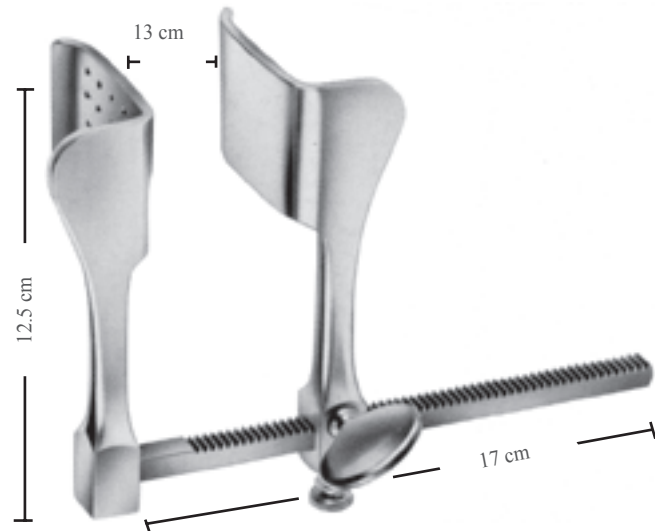

TUFFIER
BM-7400
Göğüs ekartörü/Rib Retractor
Bleydler/Blades
43 x 53 mm

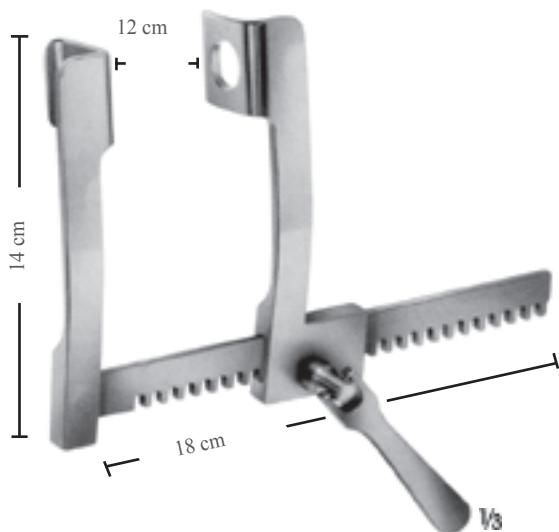

FINOCHIETTO
BM-7700
Göğüs ekartörü/Rib retractor
Bleydler/Blades
28 x 32 mm

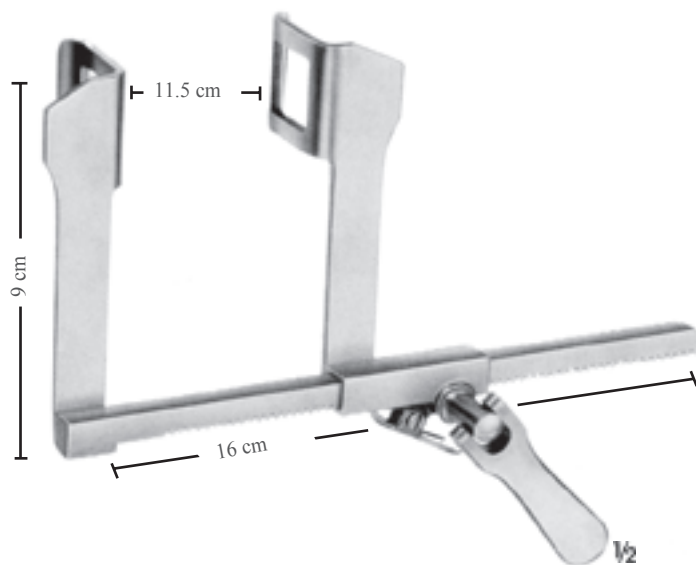

HAIGHT
BM-7600
Göğüs ekartörü/Rib retractor
Bleydler/Blades
30 x 30 mm



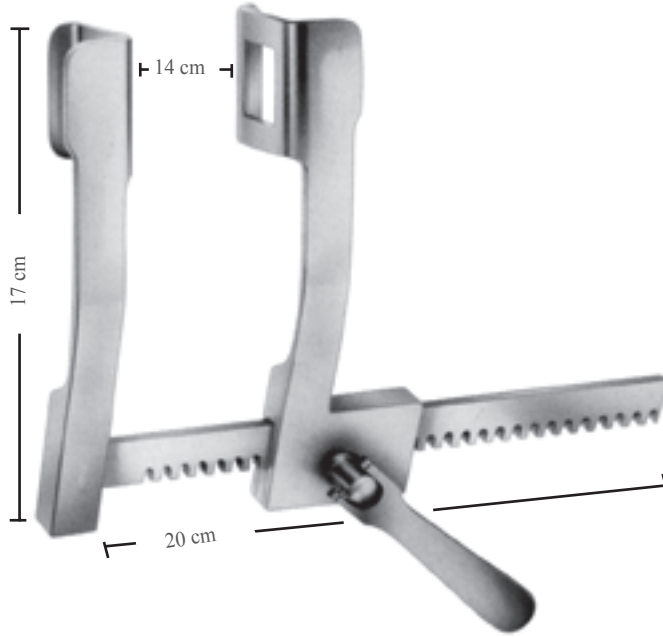

FINOCHIETTO
BM-7800
Bleydler/Blades
36 x 45 mm

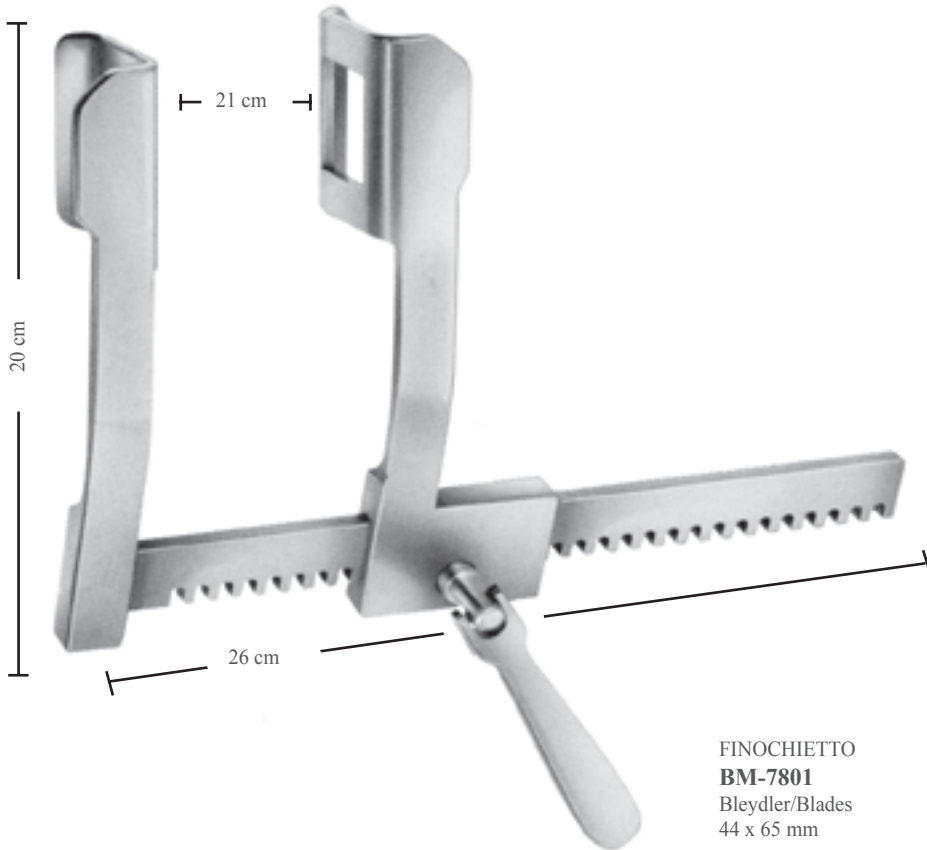

FINOCHIETTO
BM-7801
Bleydler/Blades
44 x 65 mm

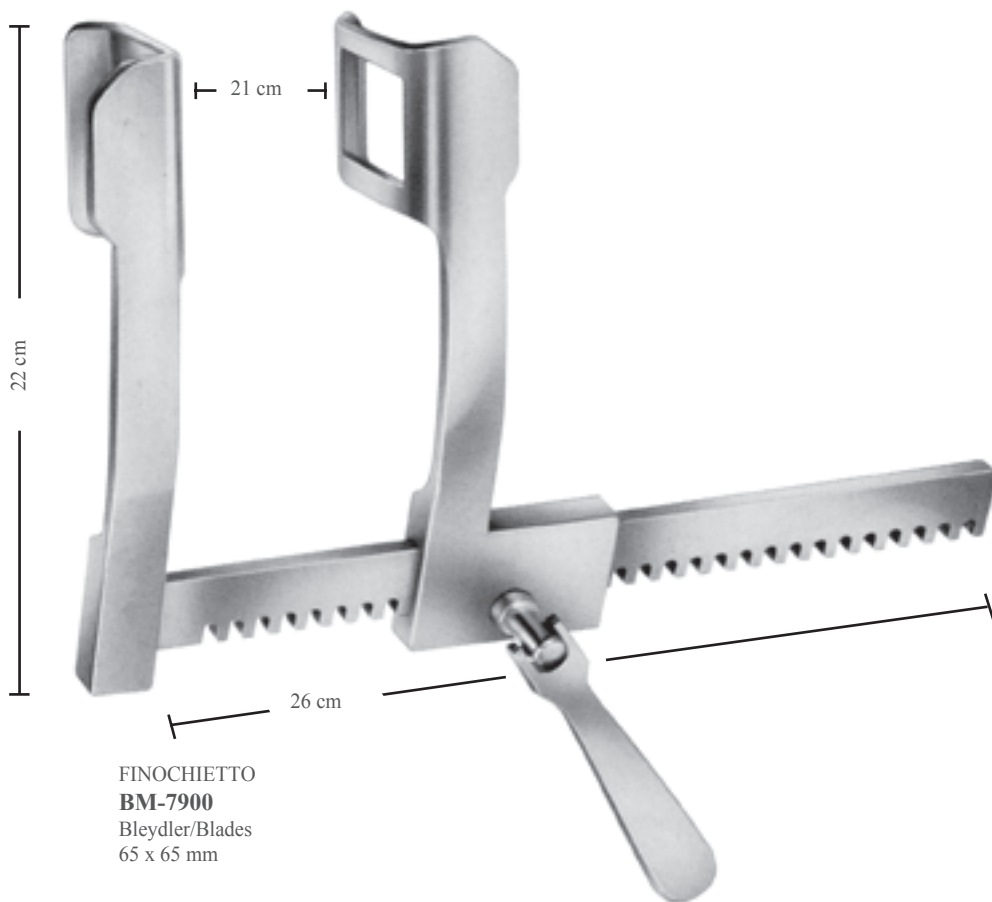

FINOCHIETTO
BM-7900
Bleydler/Blades
65 x 65 mm

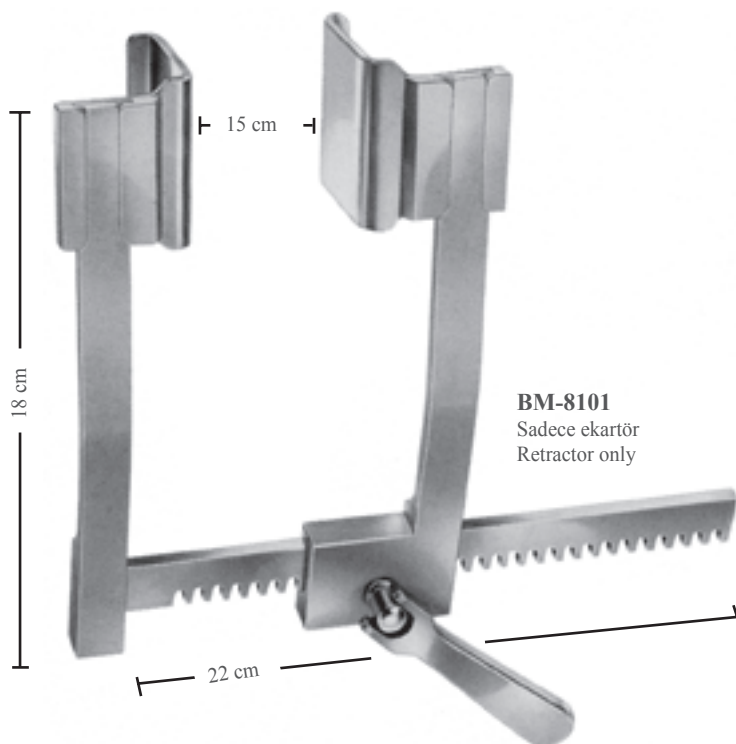

DE BAKEY
BM-8100 Komple/Complete
BM-8101 Sadece ekartör/Retractor only
BM-8102 - BM-8103 - BM-8104 Bleydler(çift)/Blades(pair)

DE BAKEY
BM-8102
Bleydler/Blades
30 x 30 mm



DE BAKEY
BM-8103
Bleydler/Blades
40 x 40 mm



DE BAKEY
BM-8104
Bleydler/Blades
50 x 50 mm





FINOCHIETTO-BURFORD
BM-8004
Bleydler/Blades
75 x 64 mm



FINOCHIETTO-BURFORD
BM-8003
Bleydler/Blades
45 x 64 mm



FINOCHIETTO-BURFORD
BM-8002
Sadece ekartör/Retractor only

22 cm

22 cm

30 cm

FINOCHIETTO-BURFORD
BM-8001 Komple/Complete
BM-8002 Sadece ekartör/Retractor only
BM-8003 Bleydler(çift)/Blades(pairs)
BM-8004 Bleydler(çift)/Blades(pairs)

Özel Avantajlar:
Değiştirilebilir bleydler için geliştirilmiş sabitleme sistemi
Avantaj Special Advantages :
Improved fixing system for interchangeable blades

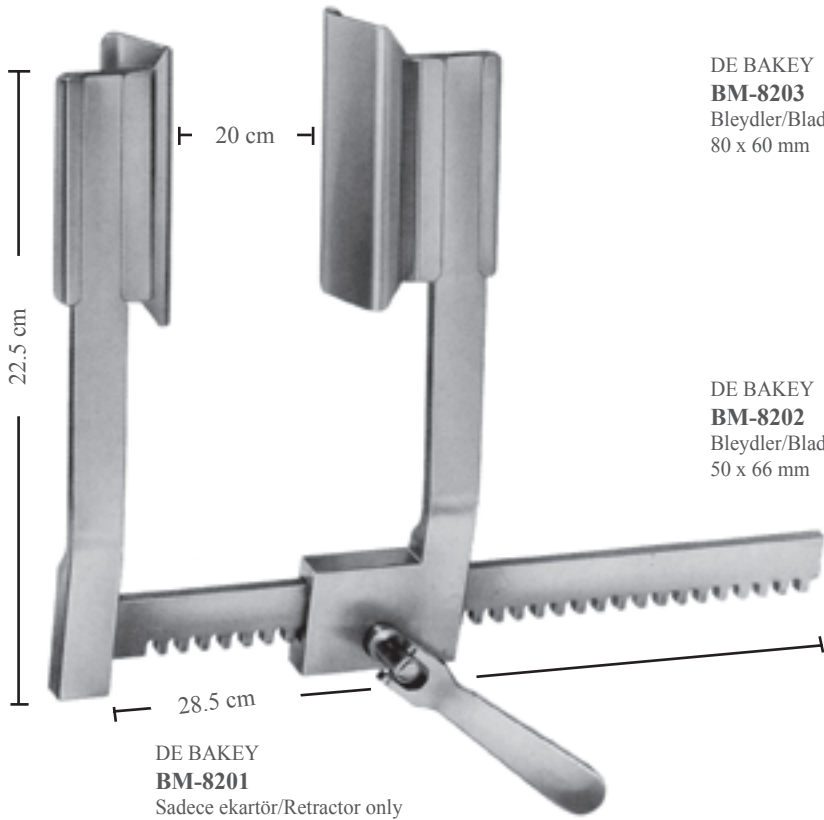

DE BAKEY
BM-8206
Bleydler/Blades
60 x 60 mm

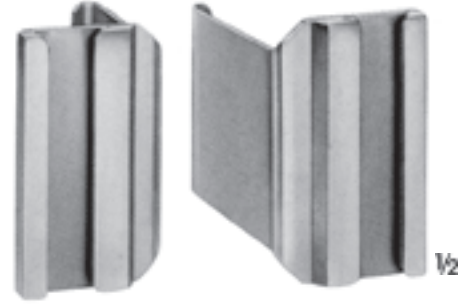

DE BAKEY
BM-8205
Bleydler/Blades
50 x 80 mm



DE BAKEY
BM-8204
Bleydler/Blades
40 x 100 mm

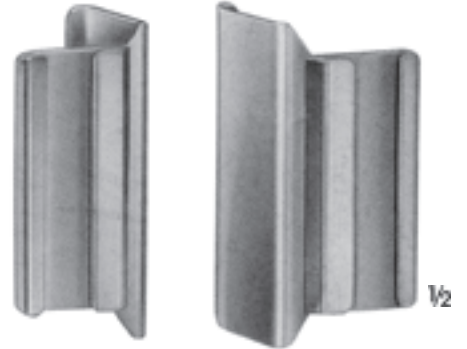

DE BAKEY
BM-8203
Bleydler/Blades
80 x 60 mm

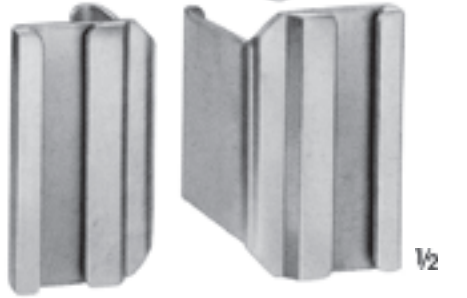

DE BAKEY
BM-8202
Bleydler/Blades
50 x 66 mm



DE BAKEY
BM-8200 Komple/Complete
BM-8201 Sadece ekartör/Retractor only
BM-8204 Bleydler(çift)/Blades(pair)
BM-8205 Bleydler(çift)/Blades(pair)
BM-8206 Bleydler(çift)/Blades(pair)



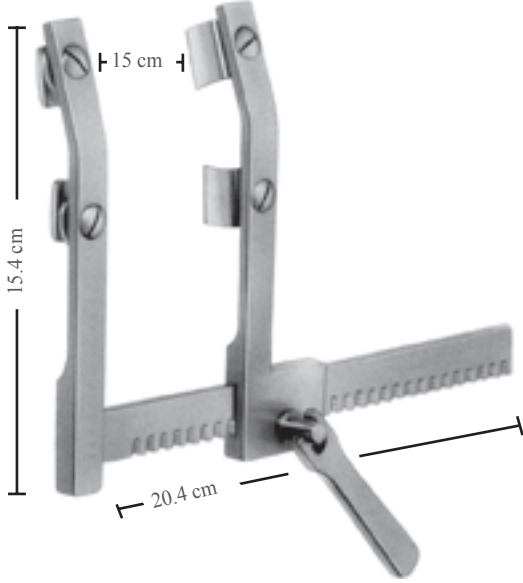

MORSE
BM-8700
Sternum ayırıcı/Sternum spreaders
Çocuklar için, hareket ettirilebilir çift bleydli
For children with movable double blades
Bleyd/Blade 12 x 20 mm

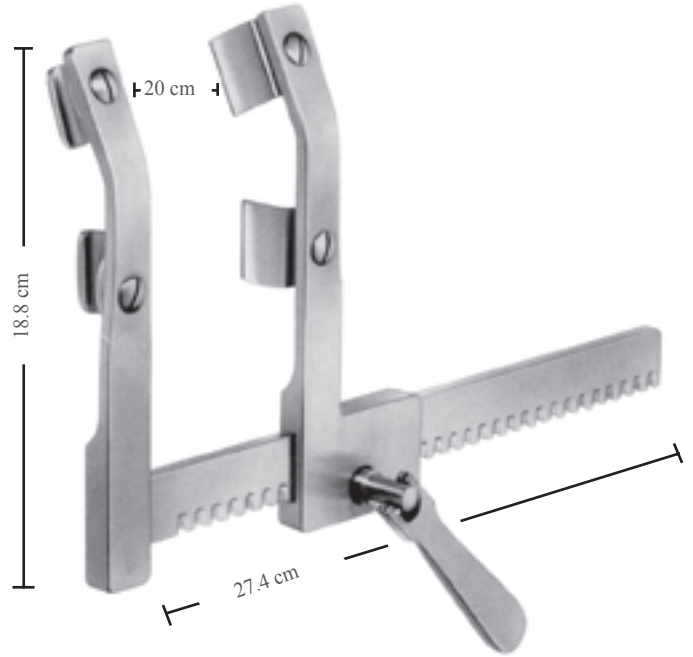

MORSE
BM-8701
Sternum ayırıcı/Sternum spreaders
Büyükler için, hareket ettirilebilir çift bleydler
For adults with movable double blades
Bleyd/Blade 19 x 29 mm

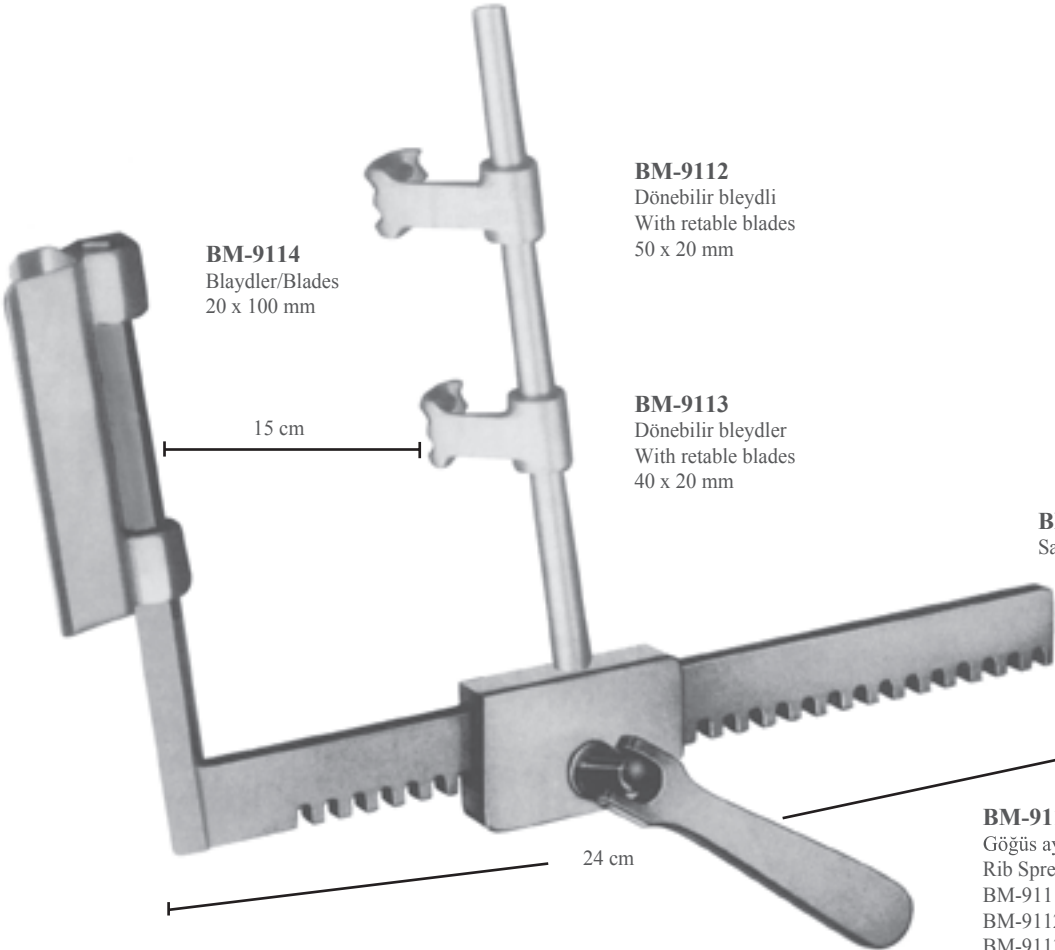

BM-9114
Blaydler/Blades
20 x 100 mm

BM-9112
Dönebilir bleydli
With retable blades
50 x 20 mm

BM-9113
Dönebilir bleydler
With retable blades
40 x 20 mm

BM-9111
Sadece ekartör/Retractor only

BM-9110
Göğüs ayırıcı komple
Rib Spreader complete
BM-9111 Sadece ekartör/Retractor only
BM-9112 Bleyd(çift)/Blade(pair)
BM-9113 Bleyd(çift)/Blade(pair)
BM-9114 Bleyd(çift)/Blade(pair)

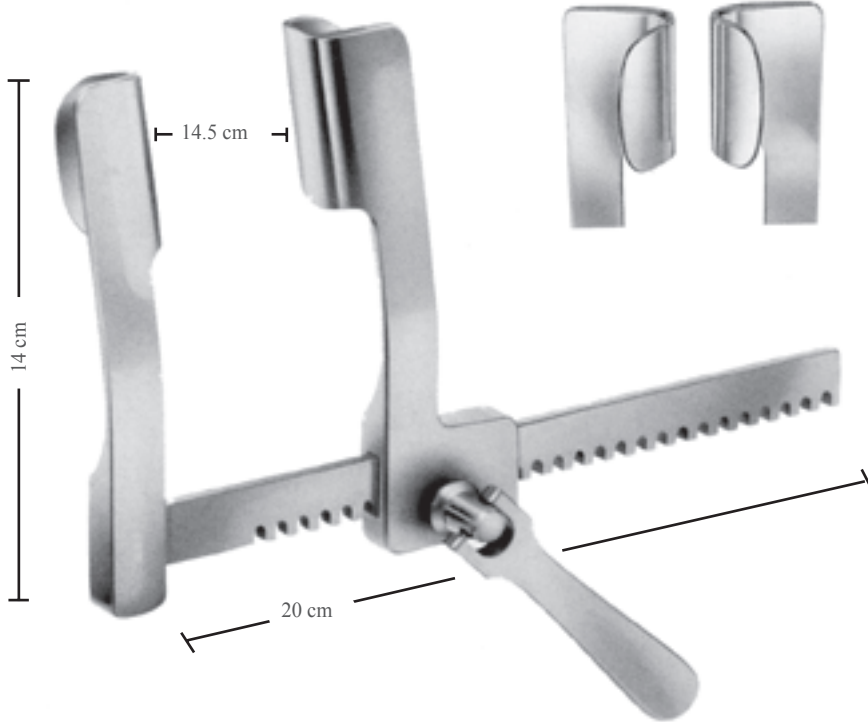

COOLEY
BM-9130
Bleydler/Blades 21 x 45 mm
Çocuklar için/For children

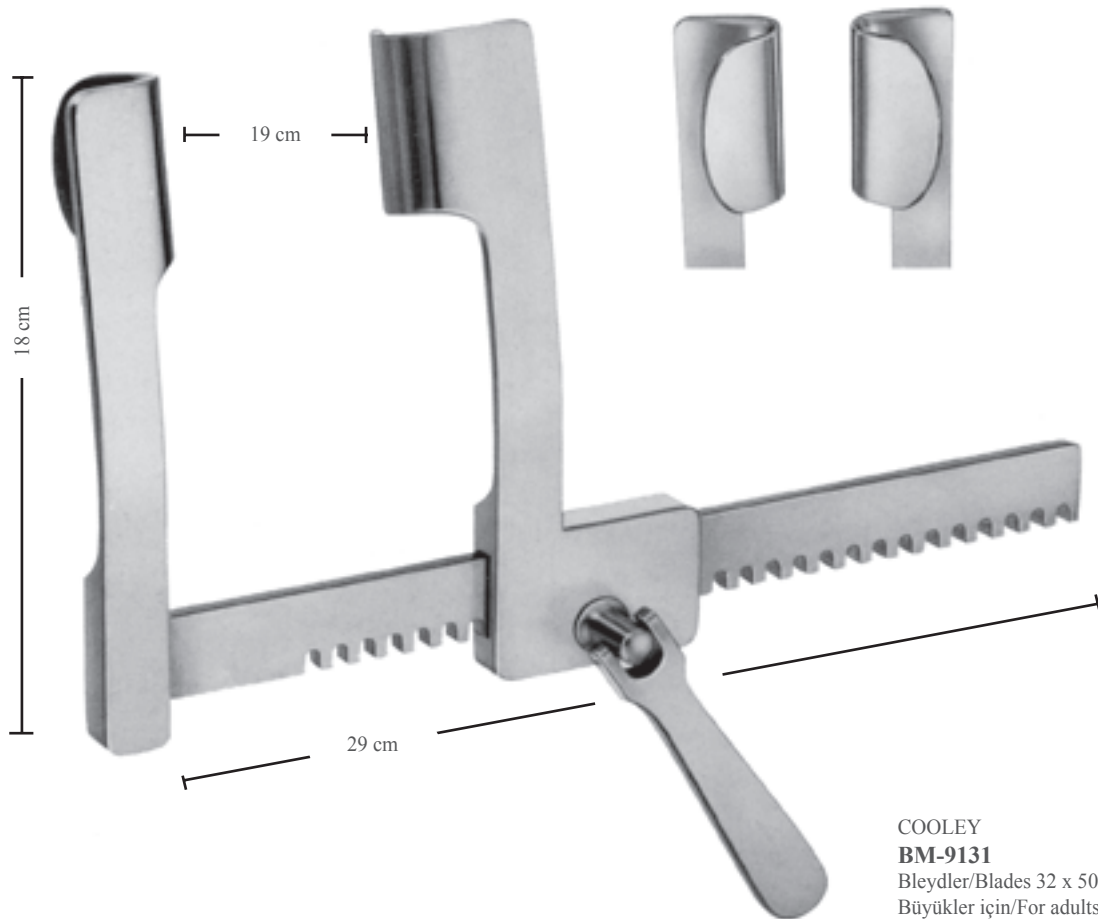

COOLEY
BM-9131
Bleydler/Blades 32 x 50 mm
Büyükler için/For adults





Sternum ekartör veya mamma interna'nın operasyonuna hazırlanması için kullanılır.

Used as Sternum retractor or used for preparation of the arteria mamma interna.

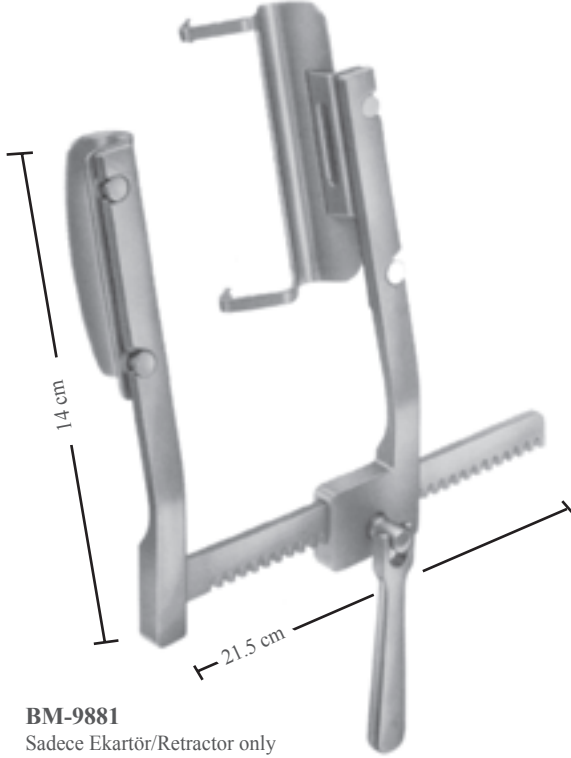

BM-9881
Sadece Ekartör/Retractor only

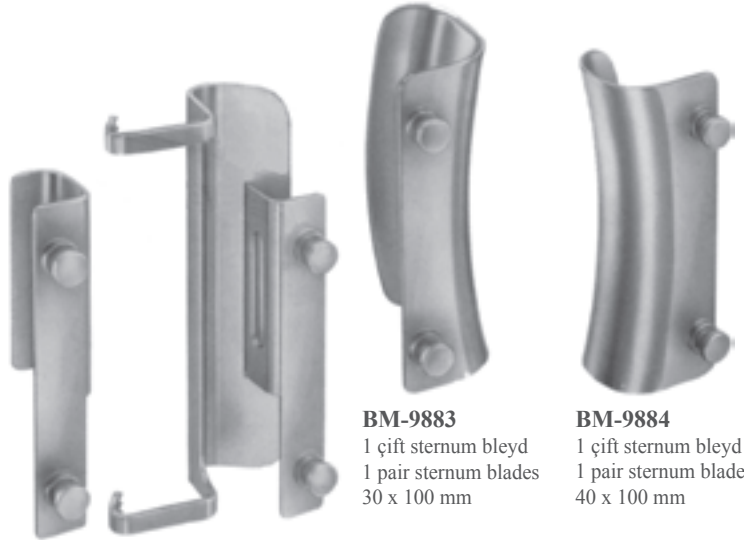

BM-9882
Mamaria bleyd komple
Mammaria blade, complete

BM-9883
1 çift sternum bleyd
1 pair sternum blades
30 x 100 mm

BM-9884
1 çift sternum bleyd
1 pair sternum blades
40 x 100 mm

BM-9880
Mamaria ekartörü komple/Mammaria retractor complete
BM-9881 Sadece ekartör/Retractor only
BM-9882 Mamaria bleyd komple/Mammaria blade complete
BM-9883 Sternum bleydler(Çift)/Sternum blades(Pair)
BM-9884 Sternum bleydler(Çift)/Sternum blades(Pair)

IMA Bleyd/IMA Blade

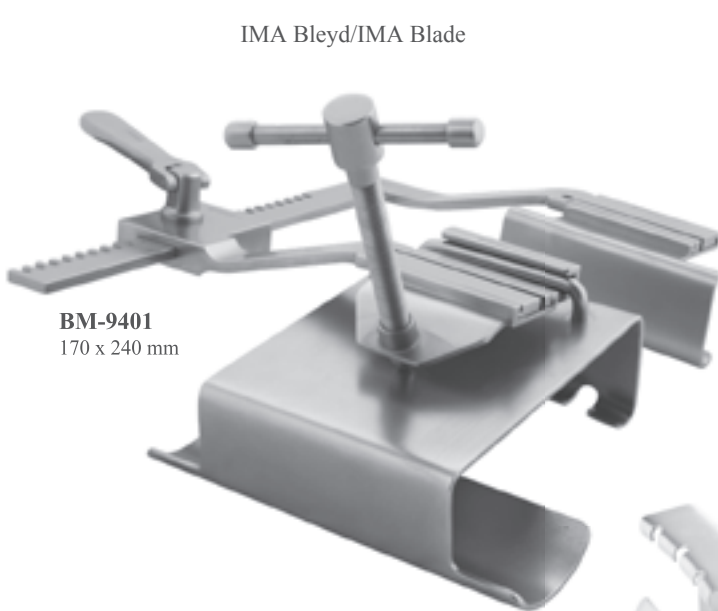

BM-9401
170 x 240 mm



BM-9407



BM-9408

BM-9409
Torasik Ekartör komple/Thoracic retractor complete
BM-9401 Sadece ekartör/Retractor only
BM-9403 Bleyd 1 adet/Blade 1 Piece
BM-9404 Bleyd 1 adet/Blade 1 Piece
BM-9406 Bleyd 1 adet/Blade 1 Piece
BM-9407 Bleyd 1 adet/Blade 1 Piece
BM-9408 Bleyd 1 adet/Blade 1 Piece



BM-9403
80 x 100 mm



BM-9404
100 x 120 mm



BM-9406
38 x 100 mm

Valf ekartör Sistemi

- Düşük operasyon platformu operasyon alanında cerrahın hareketleri için serbestlik sağlar.
- Aksesuar ve hukların sağlam tesbiti ve mükemmel uygulaması hızlı bağlantı konforu ile birleştirilmiştir.
- Taşıyıcılar kolların ve ayırıcı barların üzerine istenilen pozisyonda takılabilir veya sabitlenebilir.
- Yeni derin valf ekartör dizaynı derin göğüs kafesine sahip hastalarda çalışmak için uygundur.

Valve Retractor System

- The low operating platform provides freedom for surgeon movements in operation area.
- Strong fixation of accessories and hooks and excellent application combined with fast connection comfort.
- Carriers, can be fitted or fixed in any position on the arms and distinctive bars.
- The new deep-valve design of retractor is optimized to work on patients with deep rib cage.



BM-9321 21 x 20 cm
Sadece Ekartör/Retractor only

BM-9320 Komple/Complete

- BM-9321 Sadece ekartör/Retractor only
- BM-9322 Bleyd 2 adet/Blade 2 piece
- BM-9323 Bleyd 2 adet/Blade 2 piece
- BM-9324 Bleyd 4 adet/Blade 4 piece
- BM-9325 Bleyd 4 adet/Blade 4 piece
- BM-9326 Bağlantı klemp 3 adet/Fixation clamp 3 piece
- BM-9327 Ekartör 2 adet/Retractor 2 piece
- BM-9328 Ekartör 2 adet/Retractor 2 piece
- BM-9329 Ekartör 2 adet/Retractor 2 piece



BM-9326
Bağlantı elmanı
Joint piece



BM-9324 30 x 28 mm
BM-9325 40 x 28 mm



BM-9322 30 x 100 mm
BM-9323 40 x 100 mm



BM-9327 Küçük/Small 18 x 52 mm
BM-9328 Orta/Medium 18 x 80 mm
BM-9329 Büyük/Large 22 x 80 mm





BM-9143
Bleydler/Blades 75 x 75 mm



BM-9142
Bleydler/Blades 42 x 65 mm



BM-9141
Sadece Ekartör/Retractor only

- BM-9140** Komple/Complete
BM-9141 Sadece ekartör/Retractor only
BM-9142 Bleyd(çift)/Blade(pair)
BM-9143 Bleyd(çift)/Blade(pair)

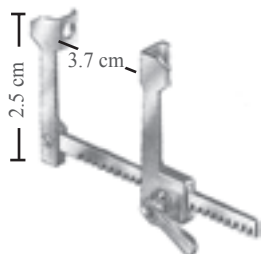

MINI FINOCHIETTO
BM-9510
Bleydler/Blades 6 x 7 mm

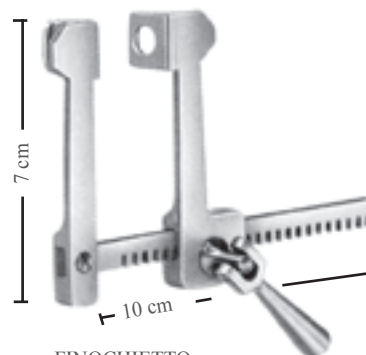

FINOCHIETTO
BM-9600
Bleydler/Blades
12 x 15 mm

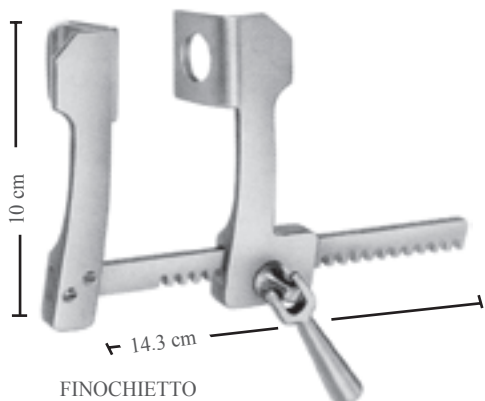

FINOCHIETTO
BM-9601
Bleydler/Blades
28 x 30 mm

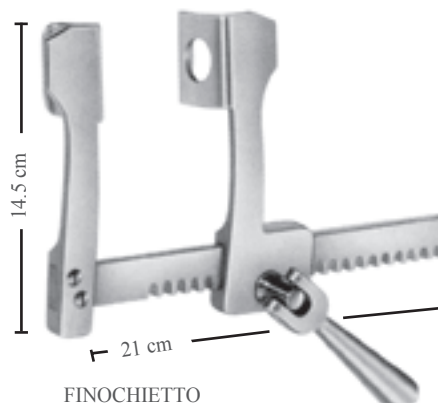

FINOCHIETTO
BM-9602
Bleydler/Blades
31 x 45 mm

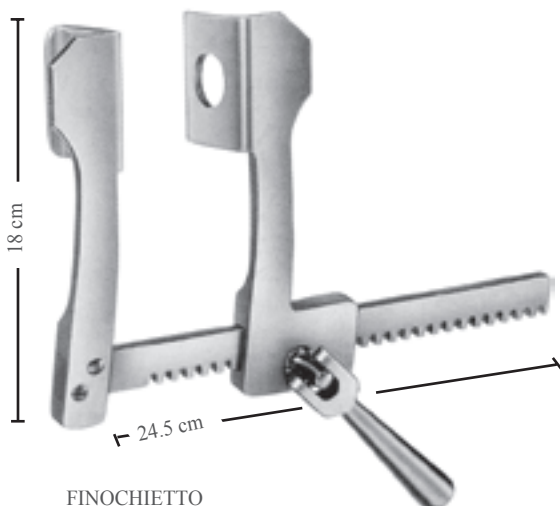

FINOCHIETTO
BM-9603
Bleydler/Blades
42 x 61 mm

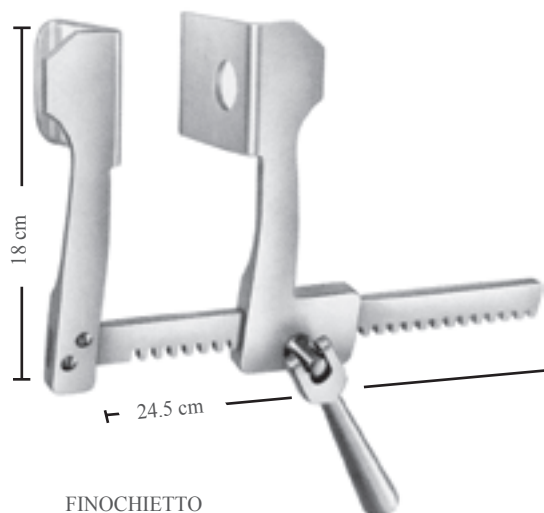

FINOCHIETTO
BM-9604
Bleydler/Blades
74 x 64 mm





45 x 30 mm

1/2

COOLEY
BK-8601
İnce dişli/Slightly serrated
26.5 cm



45 x 35 mm

1/2

COOLEY
BK-8603
İnce Dişli/Slightly serrated
26.5 cm



45 x 48 mm

1/2

COOLEY
BK-8605
Sağ, ince dişli/Right, slightly serrated
27 cm





45 x 48 mm

1/2

COOLEY
BK-8620
Sağ/Right
27 cm



25 x 46 mm

1/2

COOLEY
BK-8622
Sol/Left
28 cm





COOLEY
BK-8600 45 x 30 mm
BK-8602 45 x 35 mm
BK-8604 45 x 48 mm
İnce dişli/Slightly serrated
26.5 cm



COOLEY
BK-8610 45 x 30 mm
BK-8611 45 x 35 mm
BK-8612 45 x 48 mm
Dişsiz/Unserrated
24.5 cm



COOLEY
BK-8621 25 x 46 mm
Sol/Left
28 cm



1/2

BOROWSKI
BK-8590 - BK-8595
Bükülebilir şaft/Malleable shaft
27 cm



BK-8590
17 x 21 mm



BK-8591
16 x 23 mm



BK-8592
20 x 25 mm



BK-8593
24 x 27 mm



BK-8594
28 x 20 mm



BK-8595
28 x 29 mm



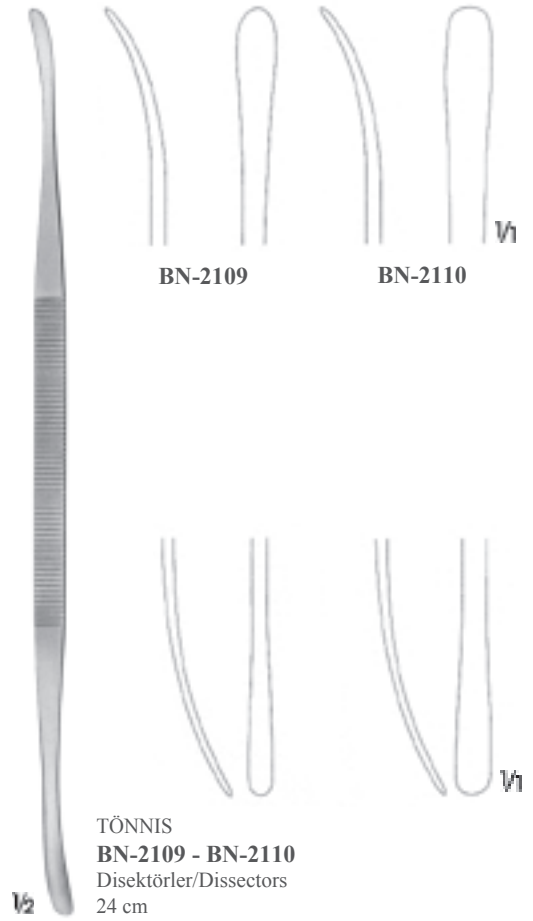
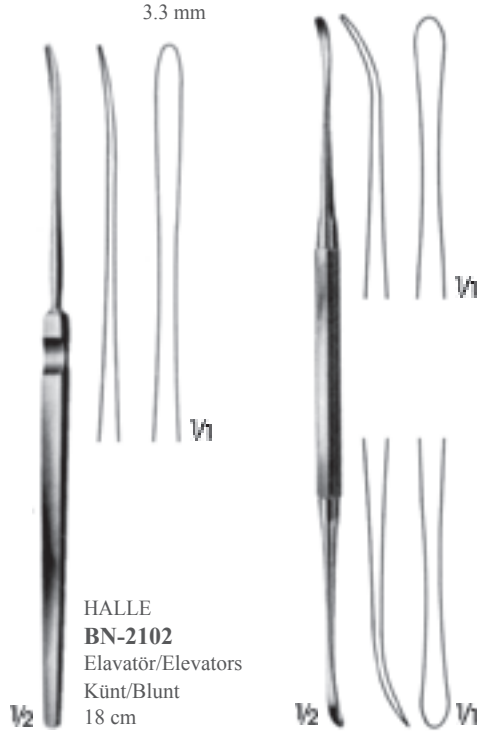
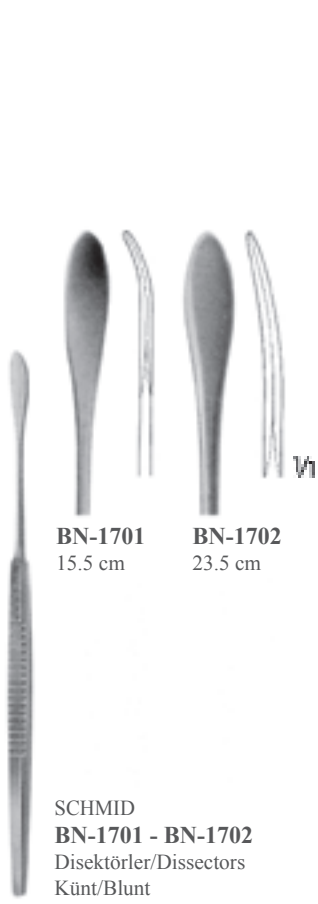

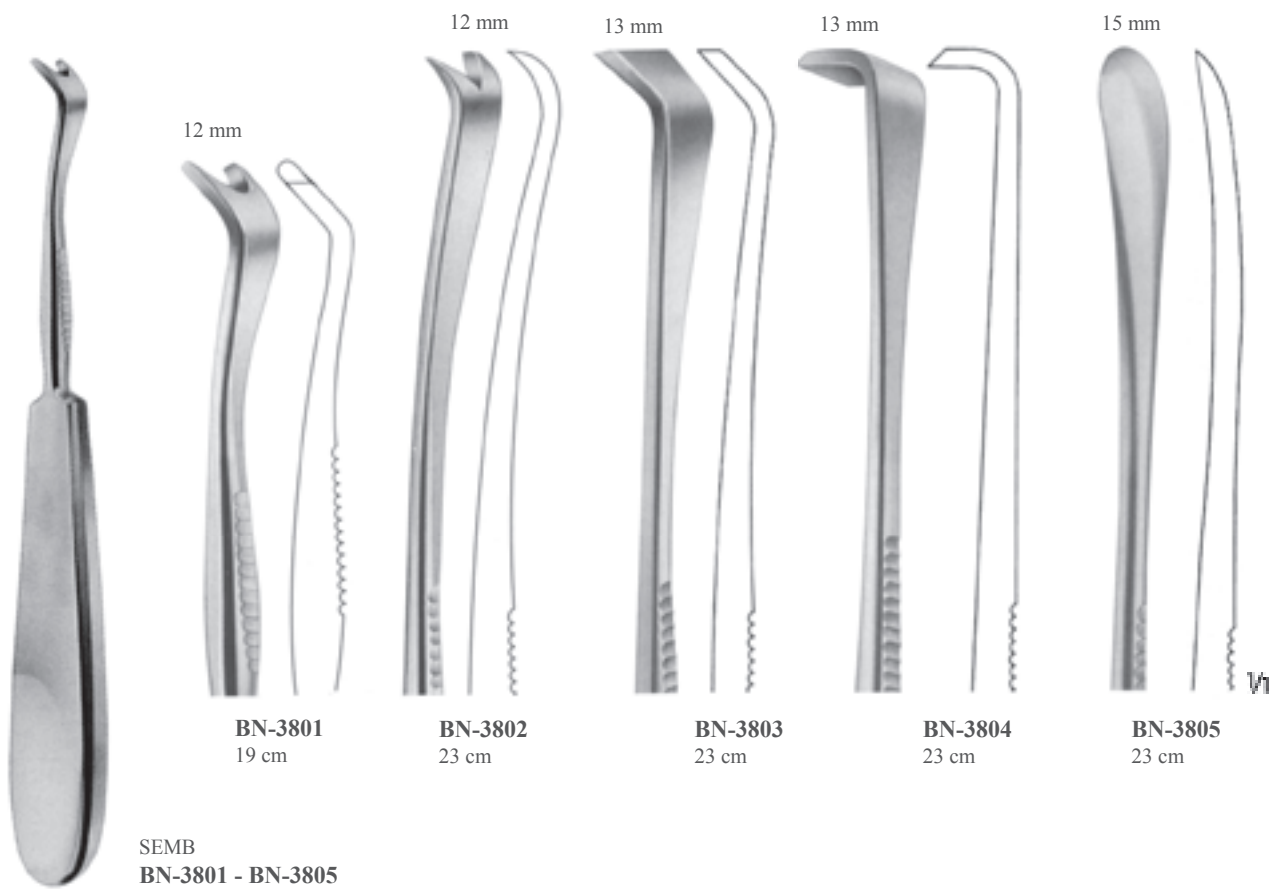

SEMB
BN-3801 - BN-3805

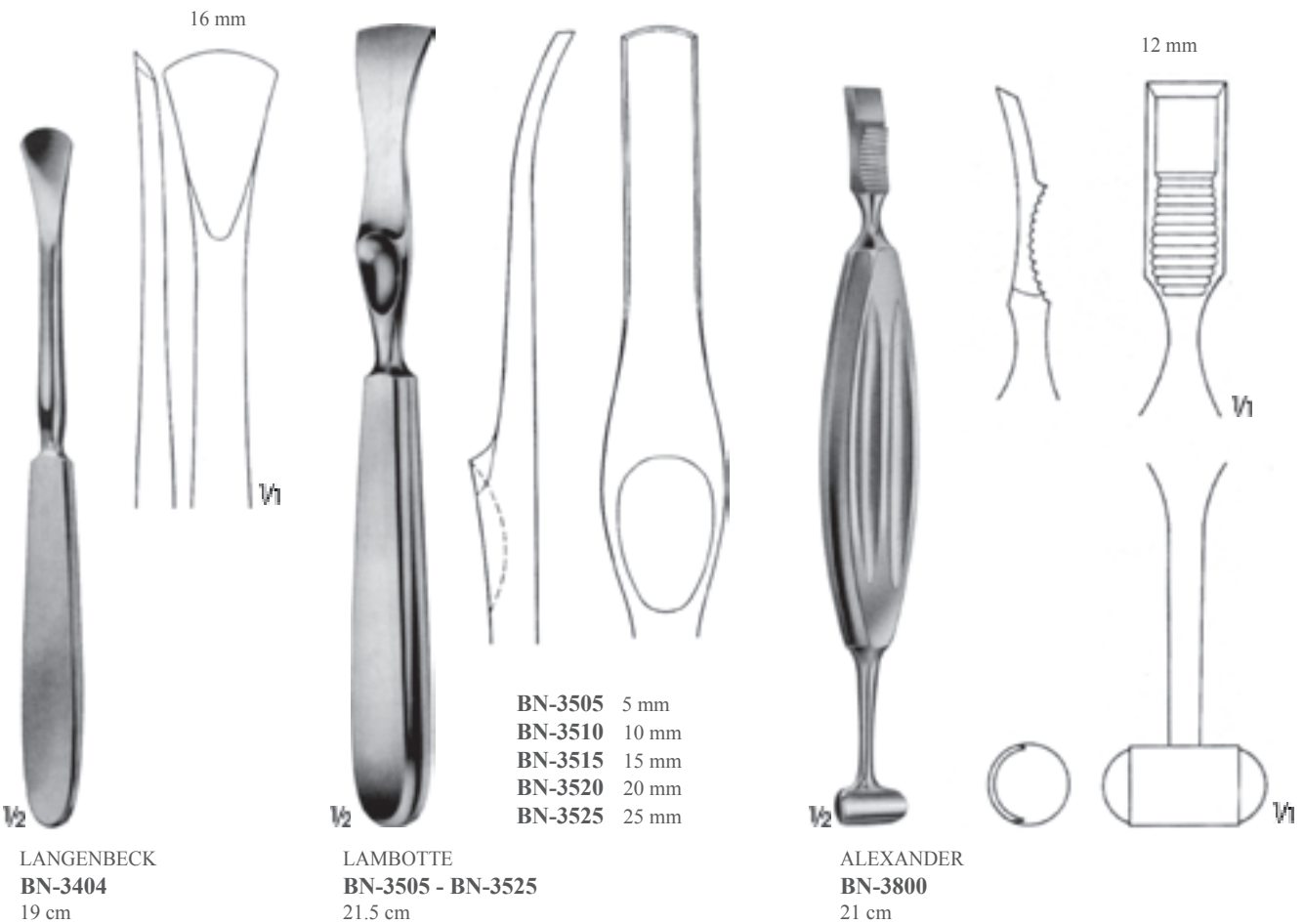

LANGENBECK
BN-3404
19 cm

LAMBOTTE
BN-3505 - BN-3525
21.5 cm

ALEXANDER
BN-3800
21 cm





BJ-8616
Esnek plastik sonda ucu
Flexible plastic probe tip



BJ-8617
Ø 3 mm
Metal sonda ucu
Metal Probe tip



BJ-8618
Ø 6 mm



BJ-8619
Ø 9 mm



BJ-8620
Ø 12 mm



BJ-8621
Ø 15 mm



NABATOFF
BJ-8622
Sadece sap
Handle only

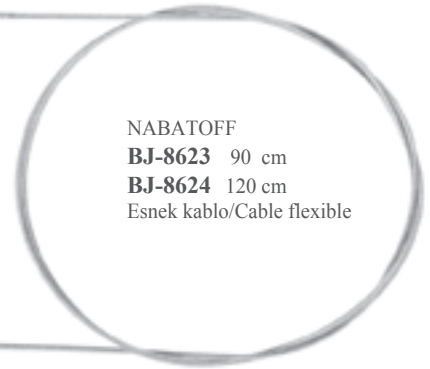

NABATOFF
BJ-8623 90 cm
BJ-8624 120 cm
Esnek kablo/Cable flexible

NABATOFF

- BJ-8614** Damar temizleme seti/Vein stripper set, consisting of
BJ-8615 Metal kutu/Metal case
BJ-8623 Esnek kablo 90 cm/Flexible cable 90 cm
BJ-8616 Esnek plastik sonda ucu/Flexible plastic probe tip
BJ-8617 Metal sonda ucu/Metal Probe tip
BJ-8618 Metal uç/Metal end Ø 6 mm
BJ-8619 Metal uç/Metal end Ø 9 mm
BJ-8620 Metal uç/Metal end Ø 12 mm
BJ-8621 Metal uç/Metal end Ø 15 mm
BJ-8622 Esnek kablo sapı/Handle for flexible cable



VARADY
BJ-8625 Mini damar temizleme seti
Mini vein stripper set
BJ-8615 Metal kutu/Metal case
BJ-8626 Esnek kablo 45 cm/Flexible cable 45 cm
BJ-8633 Metal uc/Metal end Ø 3 mm
BJ-8634 Metal uc/Metal end Ø 4 mm
BJ-8635 Metal uc/Metal end Ø 5 mm



VARADY
BJ-8626
Esnek kablo
Flexible cable
45 cm



BJ-8633
Ø 3 mm



BJ-8634
Ø 4 mm



BJ-8635
Ø 5 mm



VARADY
BN-5203
Mikro çıkartıcı
Micro Extractor
17 cm

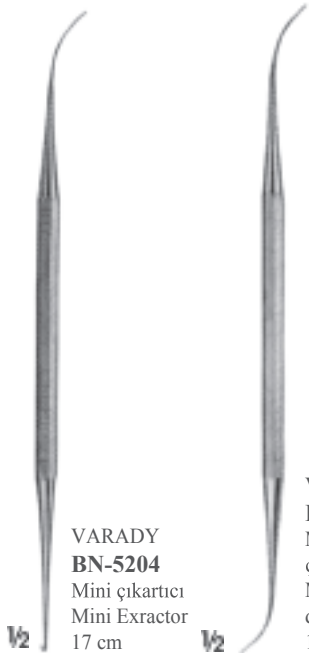

VARADY
BN-5204
Mini çıkartıcı
Mini Extractor
17 cm



VARADY
BN-5205
Mikro spatula,
çift taraflı
Micro spatula,
double ended
17.5 cm



VARADY
BN-5200
Dissektor
Dissector
18 cm



VARADY
BN-5201
Çıkartıcı
Extractor
18 cm



VARADY
BN-5202
Çıkartıcı
Extractor
18 cm



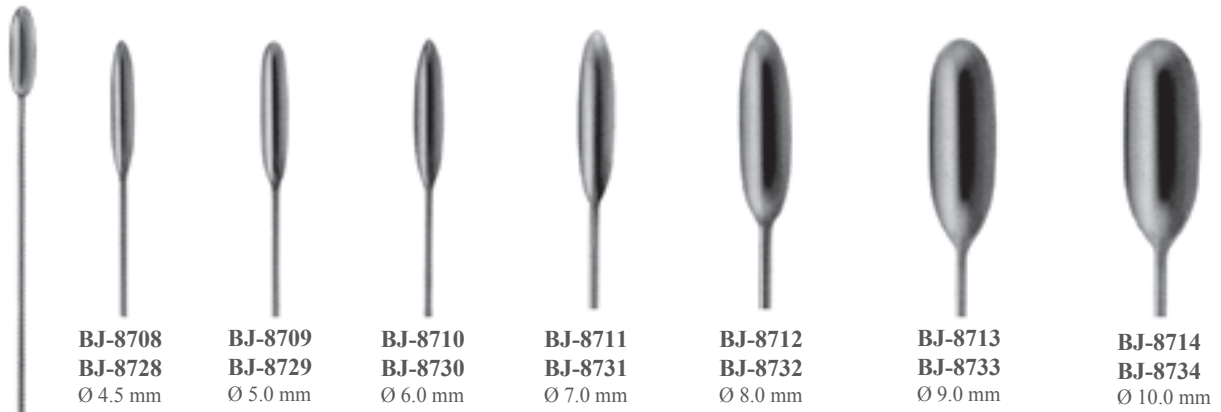
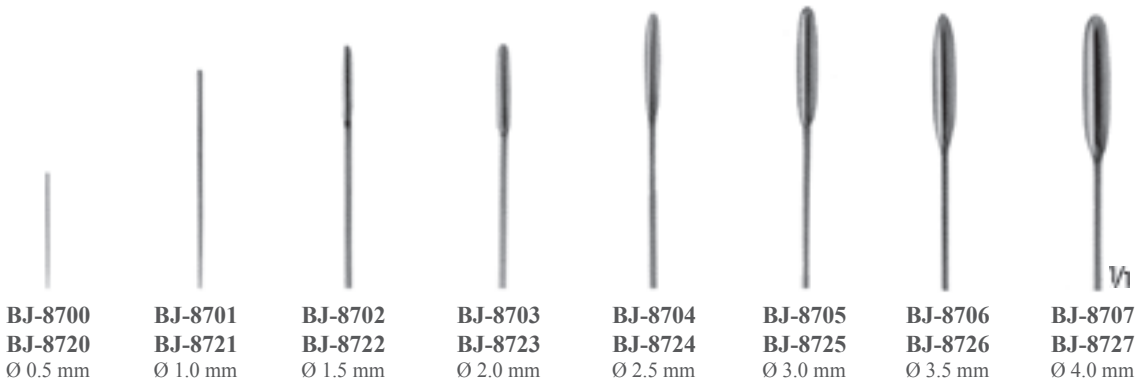

DE BAKEY

BJ-8700 - BJ-8714 19 cm

BJ-8720 - BJ-8734 38 cm

Damar dilatörleri, bükülebilir

Vascular dilators, malleable

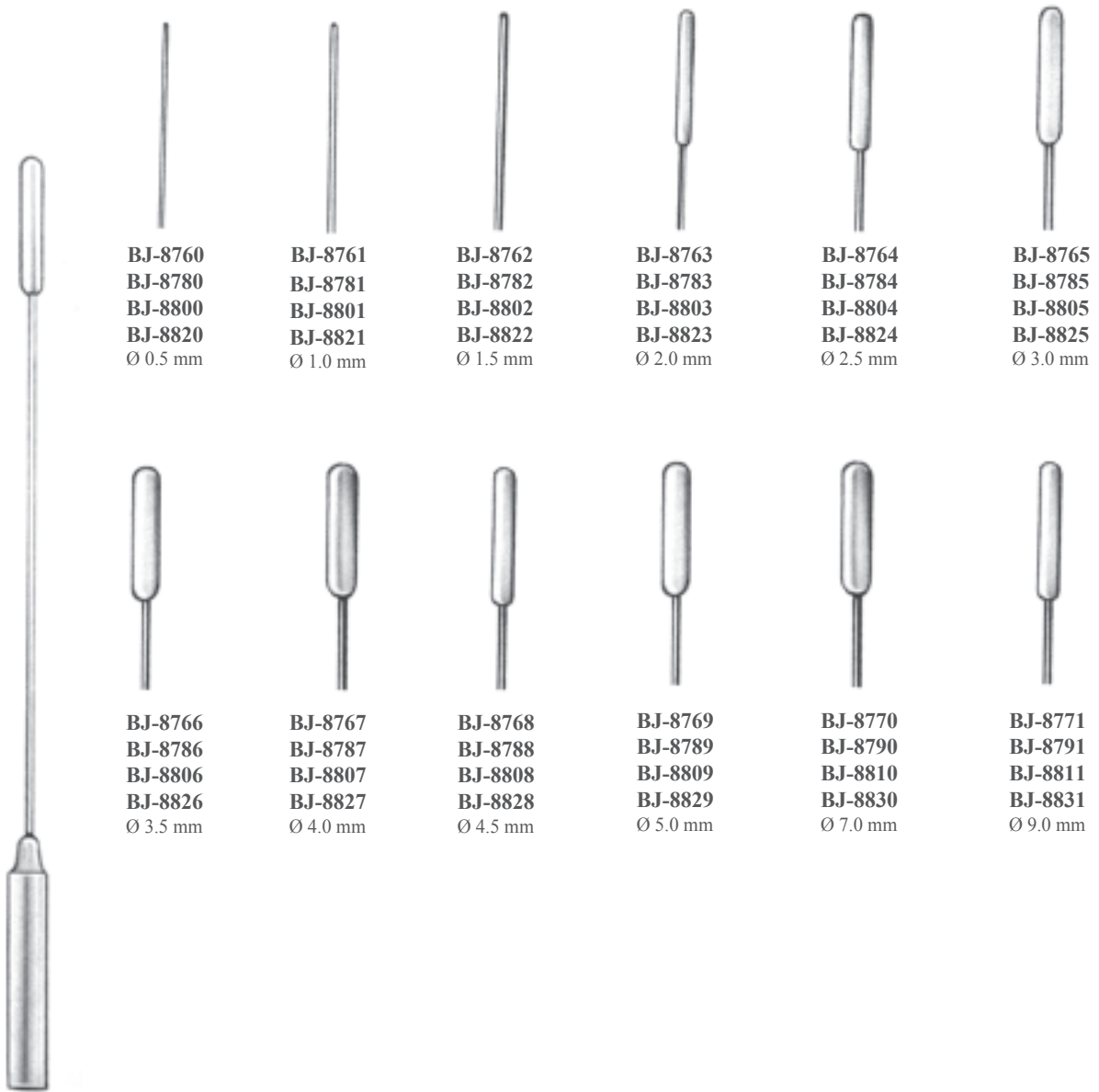

BJ-8760
BJ-8780
BJ-8800
BJ-8820
Ø 0.5 mm

BJ-8761
BJ-8781
BJ-8801
BJ-8821
Ø 1.0 mm

BJ-8762
BJ-8782
BJ-8802
BJ-8822
Ø 1.5 mm

BJ-8763
BJ-8783
BJ-8803
BJ-8823
Ø 2.0 mm

BJ-8764
BJ-8784
BJ-8804
BJ-8824
Ø 2.5 mm

BJ-8765
BJ-8785
BJ-8805
BJ-8825
Ø 3.0 mm

BJ-8766
BJ-8786
BJ-8806
BJ-8826
Ø 3.5 mm

BJ-8767
BJ-8787
BJ-8807
BJ-8827
Ø 4.0 mm

BJ-8768
BJ-8788
BJ-8808
BJ-8828
Ø 4.5 mm

BJ-8769
BJ-8789
BJ-8809
BJ-8829
Ø 5.0 mm

BJ-8770
BJ-8790
BJ-8810
BJ-8830
Ø 7.0 mm

BJ-8771
BJ-8791
BJ-8811
BJ-8831
Ø 9.0 mm

GARRET
BJ-8760 - BJ-8771 14 cm
BJ-8780 - BJ-8791 19 cm
BJ-8800 - BJ-8811 21 cm
BJ-8820 - BJ-8831 35 cm
Bükülebilir/Malleable



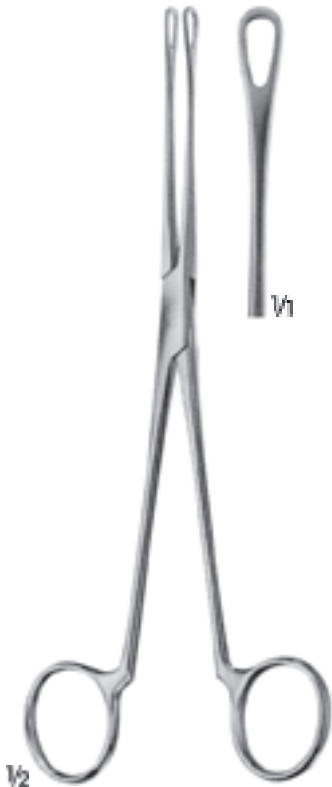

BLAKE
BE-5025
Emboli tutma pensi
Embolus grasping forceps
20.5 cm



BJ-8886
Sadece klavuz
Guide only



BJ-8887
Sadece klavuz
Guide only



RUMEL-BELMONT
Turnikeler/Tourniquets
BJ-8884 Ø 4.0 mm
BJ-8885 Ø 6.4 mm
32.5 cm



BJ-8880
(BJ-8870 - BJ-8878) için
Sap/For handle
11 cm



BJ-8870 - BJ-8878
Endarterektomi temizleyici
Endarterectomy strippers
55 cm

BJ-8870
Ø 2 mm

BJ-8871
Ø 3 mm

BJ-8872
Ø 4 mm

BJ-8873
Ø 6 mm

BJ-8874
Ø 7 mm

BJ-8875
Ø 8.5 mm

BJ-8876
Ø 10 mm

BJ-8877
Ø 12 mm

BJ-8878
Ø 14 mm



BJ-8860
Ø 3 mm



BJ-8861
Ø 4 mm



BJ-8862
Ø 5 mm



BJ-8863
Ø 6 mm

1/2 LUER
LOCK

SCHMID
BJ-8860 - BJ-8863
Damar sulama kanülleri,
bükülebilir, gümüş kaplama
Vessel irrigating cannulae,
malleable, silver plated
15 cm





BY-3504 - BY-3506

Aort pançları/Aorta punches
14 cm



BY-3504
Ø 4 mm



BY-3505
Ø 5 mm



BY-3506
Ø 6 mm

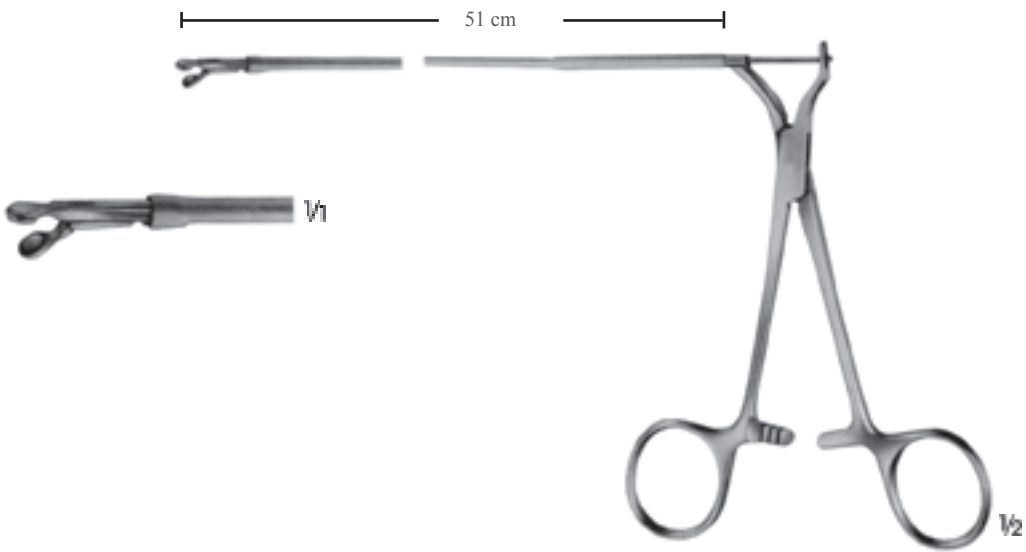

SCHULZ
BS-6900

Esnek milli biyoptom, 51 cm uzunluğunda
Ø 3 mm yuvarlak çeneli
Bioptome, with flexible shaft 51 cm long,
with round jaws Ø 3 mm

Buldog pens sürücüsü, ince ve hafif eğri yapısı ile tünel boyunca kolay ilerleme sağlar.
Buldog pensini güvenli şekilde kavrar.

The slight curvature of the introducer forceps permits handling during tunneling. Here the prosthesis can be drawn in by applying the introducer forceps directly to the prosthesis (alloplastic prosthesis) or can be drawn in by means of the bulldog clamp (autologous/homologous prosthesis). Thanks to the interlocking fit, the bulldog clamp rests non-displaceable and securely in the mouth of the introducer forceps.

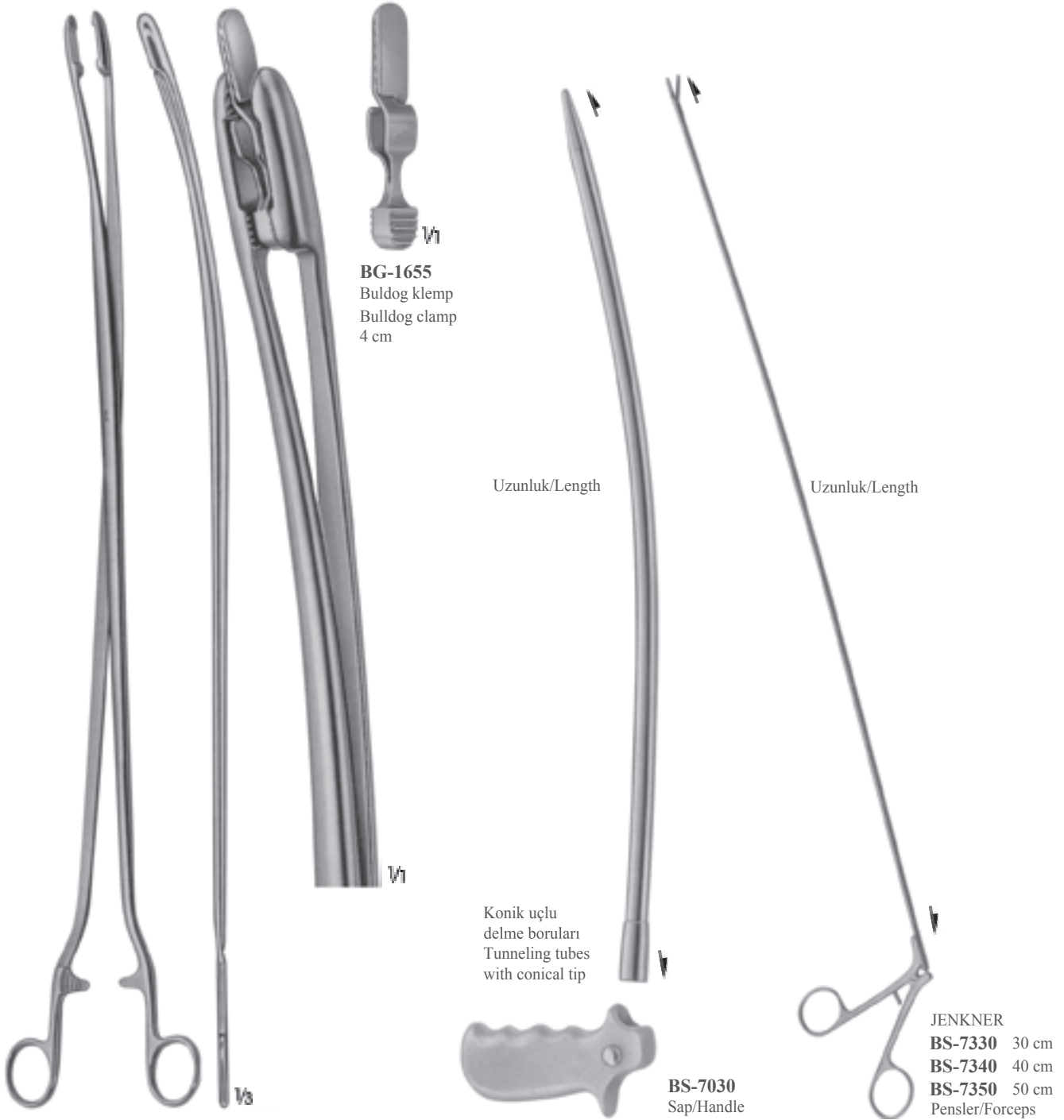

ALLENBERG
BG-1650
Eğri/Curved
54 cm

BG-1655
Buldog klamp
Bulldog clamp
4 cm

Uzunluk/Length

Uzunluk/Length

Konik uçlu
delme boruları
Tunneling tubes
with conical tip

BS-7030
Sap/Handle

JENKNER
BS-7330 30 cm
BS-7340 40 cm
BS-7350 50 cm
Pensler/Forceps

Konik uçlu delme boruları
Tunneling tubes with
conical tip

Ø 12 mm
Ø 14 mm
Ø 17 mm

Uzunluk
Length
30 cm

Uzunluk
Length
40 cm

Uzunluk
Length
50 cm

BS-7031
BS-7041
BS-7051

BS-7032
BS-7042
BS-7052

BS-7033
BS-7043
BS-7053





WITT
BJ-8914 1.5 x 35 mm
BJ-8915 1.5 x 51 mm
Sternal delme iğnesi,
Luer bağlantılı
Sternal puncture needle
with Luer cone

V1



Tek ağız tırtıllı
One jaw serrated

BRAUN-STADLER
BC-5413
Çocuklar için Sternum makası
Sternum shears for children
20 cm

V2

V1



SCHUMACHER
BR-7830
Sternum makası
Sternum shears
21 cm

V2



LEBSCHÉ
BN-5220
Sternum çizili
Sternum chisel
20 cm

V2



Ø 15 mm

FINSTERER

BJ-8890

Kombine aspiratör ucu ve irrigasyon kanülü
Combined suction and irrigation cannula
32 cm

Olive
Ø 9-13 mm



Ø 10 mm

YANKAUER

BJ-8103 Ø 2.0 mm

Merkez delikli/With central bore
28.5 cm

Olive
Ø 7-9 mm



Ø 9 mm

DE BAKEY

BJ-8106

Merkez delikli, Ø 3.0 mm yanıl yuvalı
With central bore, Ø 3.0 mm with lateral slots
27.5 cm

Olive
Ø 6-10 mm

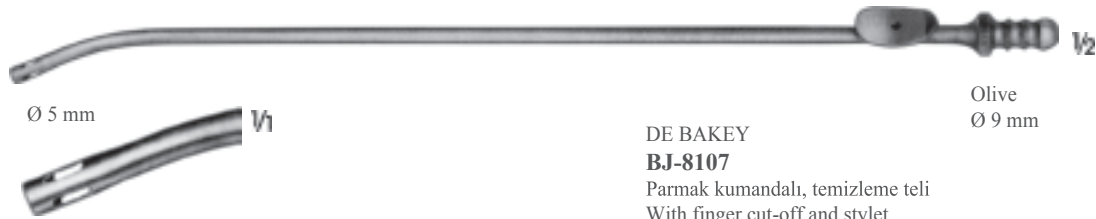

Ø 5 mm

DE BAKEY

BJ-8107

Parmak kumandalı, temizleme teli
With finger cut-off and stylet
27 cm

Olive
Ø 9 mm



Ø 5 mm

DE BAKEY

BJ-8120

Parmak kumandalı, temizleme teli
With finger cut-off and stylet
16 cm

Olive
Ø 9 mm





SEM B
BR-2200
Kaburga ve kemik tutma pensi
Rib-and bone holding forcecp
19 cm



SEM B
BR-2201
Kaburga ve kemik tutma pensi
Rib-and bone holding forcecp
19 cm



BAILEY
BV-4755
Göğüs ekartörü/Rib spreader
15 cm



SELLORS
BV-4758
Göğüs ekartörü/Rib spreader
Oynak bleydli/With swivel blades
20 cm



BAILEY
BV-4756
Çocuklar için
For children

BAILEY
BV-4757
Büyükler için
For adults

BAILEY
BV-4756 - BV-4757
Göğüs ekartörü/Rib spreader
20 cm



SAUERBRUCH
BR-7800
Çocuklar için
For children
24 cm

BR-7801
Büyükler için
For adults
27 cm



GLUCK
BR-7840
19 cm



BR-7851
23 cm



GIERTZ-STILLE
BR-7820
25 cm



BRUNNER
BR-7865
Üniversal model
Universal pattern
34 cm



BETHUNE
BR-7860
34 cm



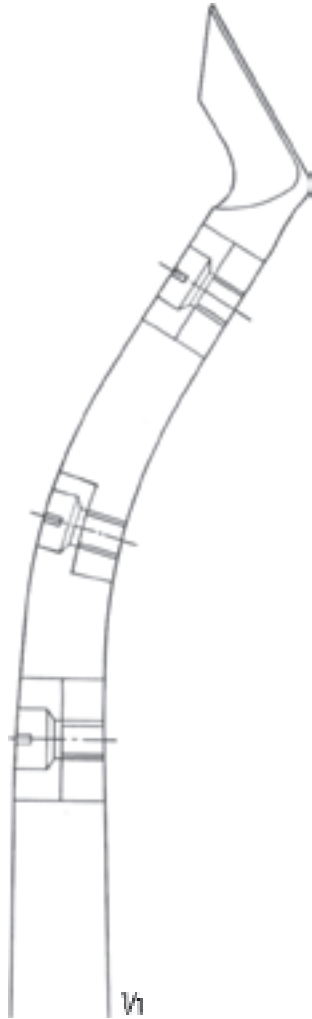

LISTON-KEY-HORSLEY
BR-4545
S şekilli, arka kaburga uçları için
S-Shaped for posterior rib ends
25.5 cm

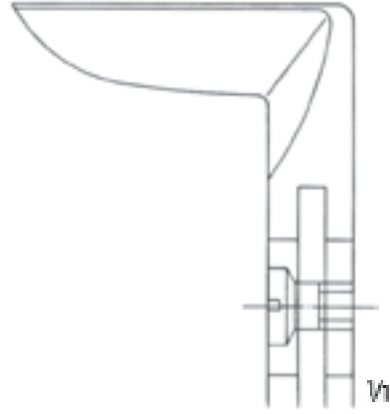

LISTON-STILLE
BR-4540
Açılı/Angled
26.5 cm

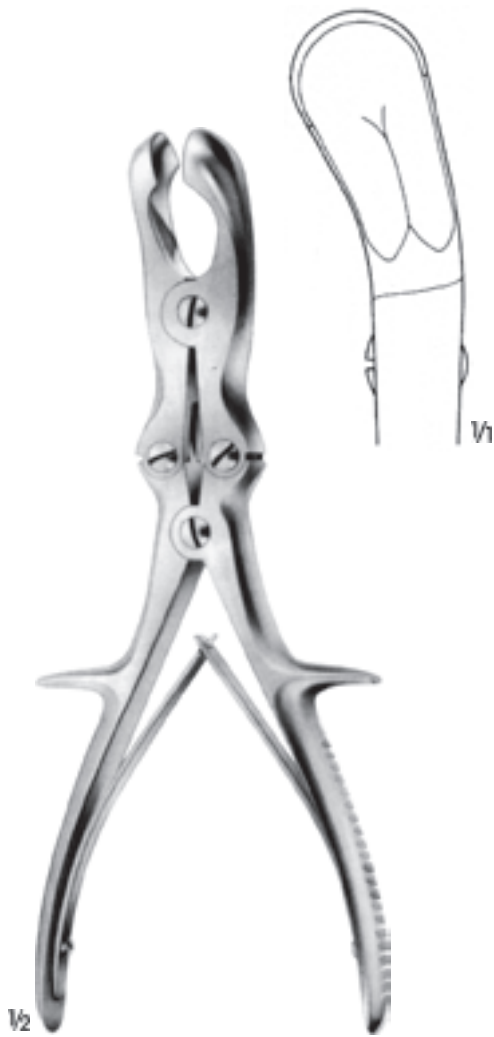

SEMB
BR-4060
Kemik ronjur
kaba kemikleri için
Rib rongeur to shorten
the rib stumps
24 cm



SAUERBRUCH-CORYLLOS
BR-4090 - BR-4091
Kemik ronjur
kaba kemikleri için
Rib rongeur to shorten
the rib stumps
31 cm



BN

Raspalar, Disektörler ve Elevatörler
Raspatories, Dissectors and Levers





V1

SWEDISH
BN-1704 18 cm
Hafif model disektör
Light pattern dissector
BN-1705 20 cm
Sert model disektör
Heavy pattern dissector



V2



V1

PENNYBACKER
BN-1706
Prob disektör
Probe dissector
23 cm



V2

DAVIS
BN-1703
Disektör
Dissector
24.5 cm



V1



V2



V1

DAVIS
BN-2112
Raspa
Raspatory
24 cm

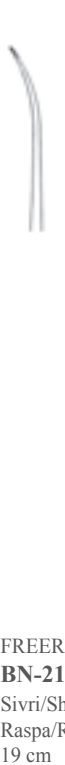

V2

FREER
BN-2105
Sivri/Sharp
Raspa/Raspatory
19 cm



V2

FREER
BN-2106
Künt/Blunt
Raspa/Raspatory
19 cm



V2

FREER
BN-2114
Sivri/Künt
Sharp/Blunt
Raspa/Raspatory
18.5 cm



V2

FREER-YASARGIL
BN-2115
Sivri/Sharp
Sivri/Sharp
Raspa/Raspatory
18.5 cm



4 mm

V1



4 mm

V1



V1



V1

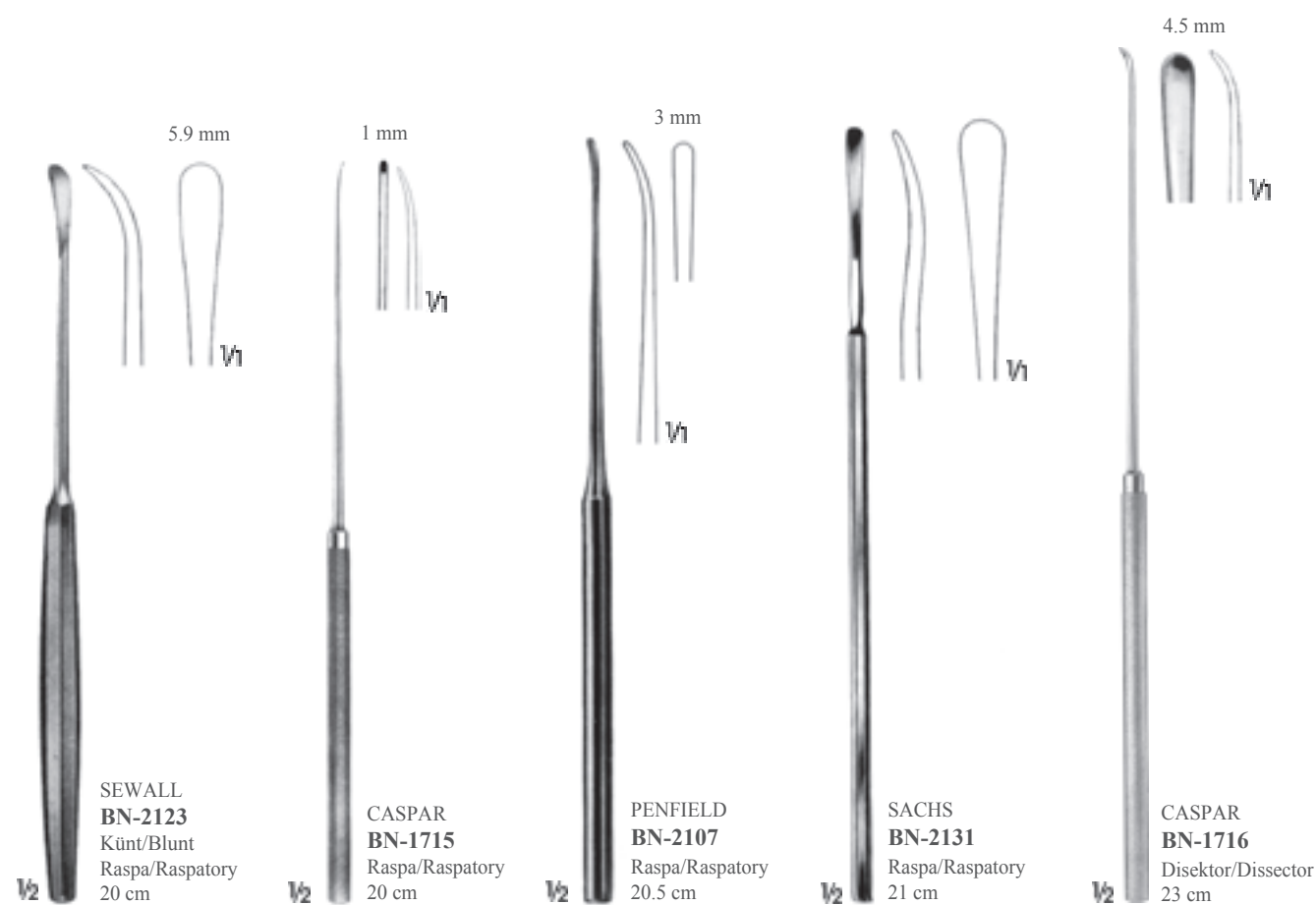
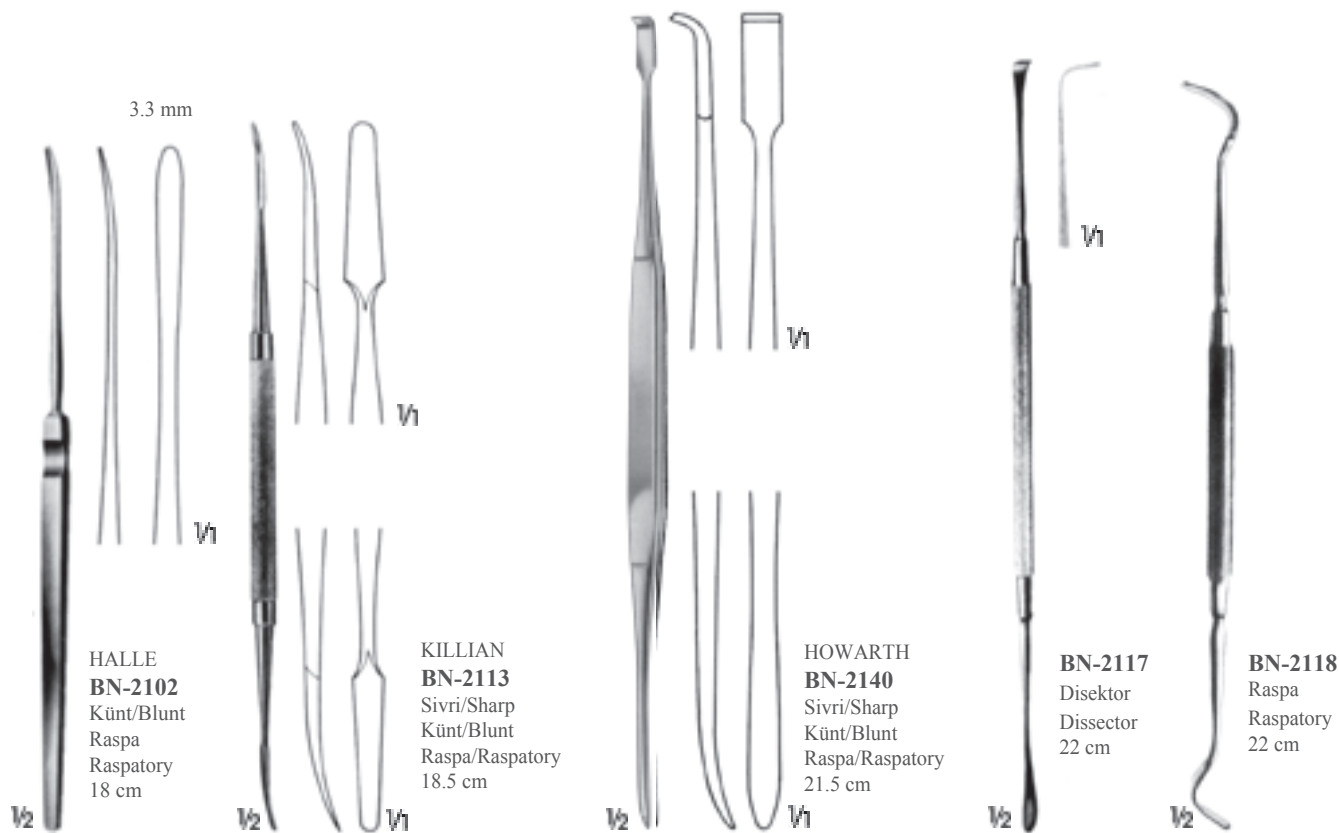

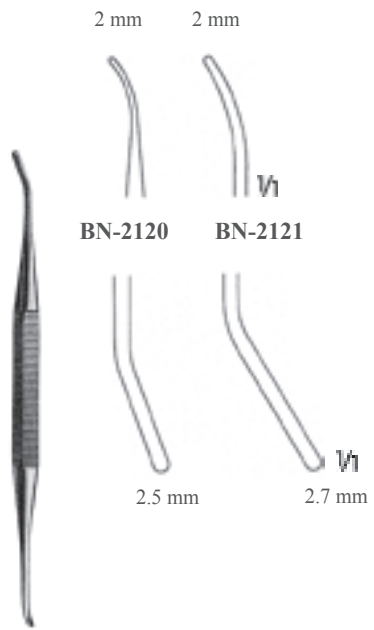

WATSON-CHEYNE
BN-2120 13 cm
BN-2121 19 cm
Raspalar/Raspatory

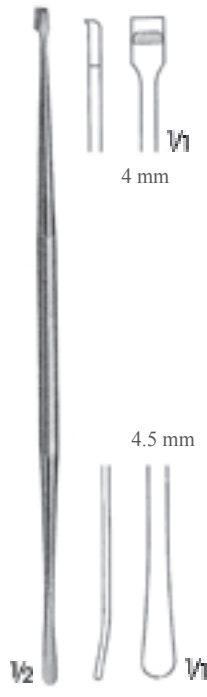

FREER
BN-2119
Raspa/Raspatory
18 cm



SYME
BN-2122 Sivri/Sharp
Raspa/Raspatory
18.5 cm

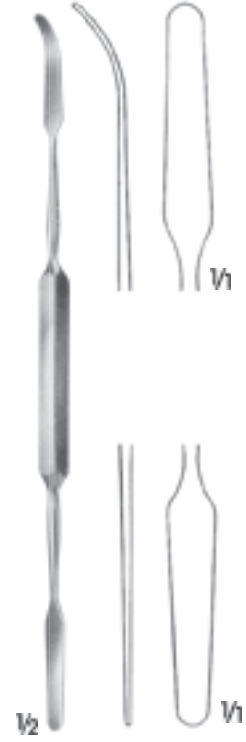

MAC DONALD
BN-2137
Künt/Blunt
Künt/Blunt
Dissektor/ Dissector
18.5 cm



PENFIELD
BN-2129
Dissektor/Dissector
Çif uçlu/Double-Ended
17.5 cm

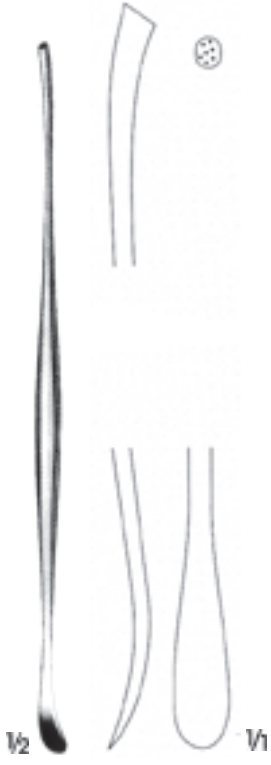

PENFIELD
BN-2124 Fig.2
Dissektor/Dissector
Çif uçlu/Double-Ended
19.5 cm



PENFIELD
BN-2125 Fig.3
Dissektor/Dissector
Çif uçlu/Double-Ended
19.5 cm



CARTER
BN-2130
Raspa/Raspatory
21 cm



FRAZIER
BN-2132
Raspa/Raspatory
15 cm



HOËN
BN-2133
Raspa/Raspatory
15 cm



HOËN
BN-2134
Raspa/Raspatory
15 cm

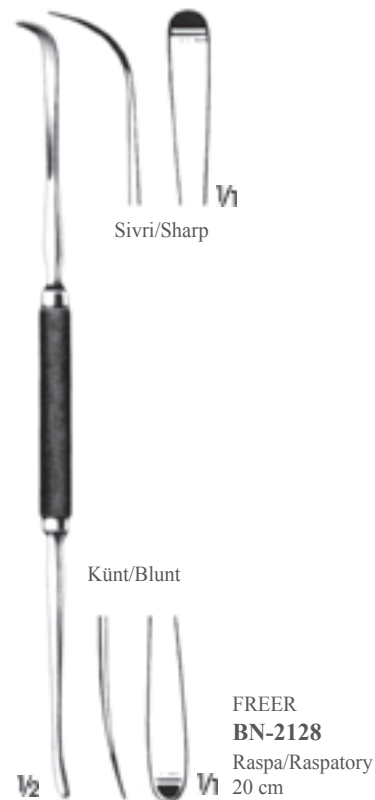

FREER
BN-2128
Raspa/Raspatory
20 cm

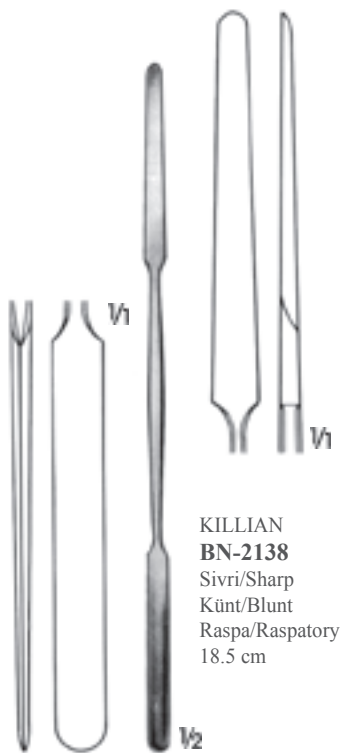

KILLIAN
BN-2138
Sivri/Sharp
Künt/Blunt
Raspa/Raspatory
18.5 cm



O'CONNELL
BN-3360
Disektor/Dissector
Çif uçlu
Double-Ended
22 cm



MILLIGAN
BN-2135
Raspa/Raspatory
21 cm



WOODSON
BN-2136
Raspa/Raspatory
25 cm



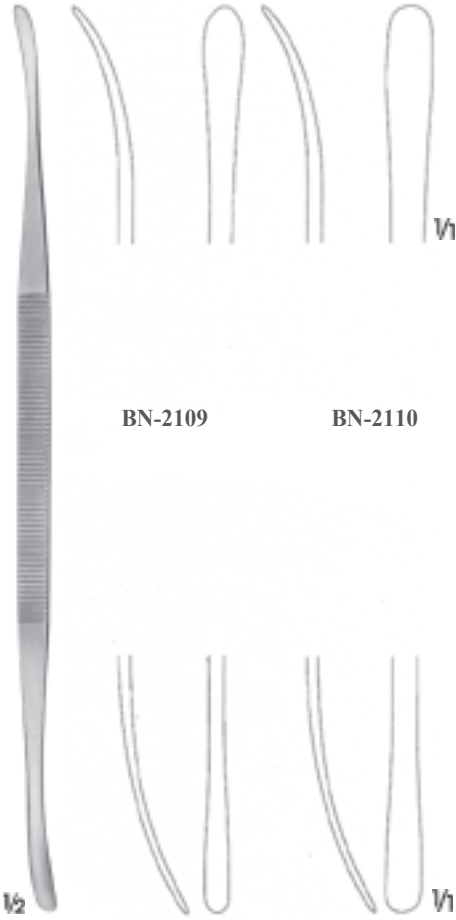

BN-2109

BN-2110

TÖNNIS
BN-2109 - BN-2110
Disektörler/Dissectors
24 cm

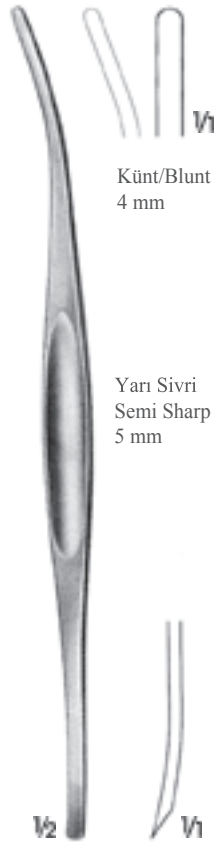

Künt/Blunt
4 mm

Yarı Sivri
Semi Sharp
5 mm

HILL
BN-2145
Raspa/Raspatory
Yarı sivri/Künt
Semi-sharp/Blunt
22 cm

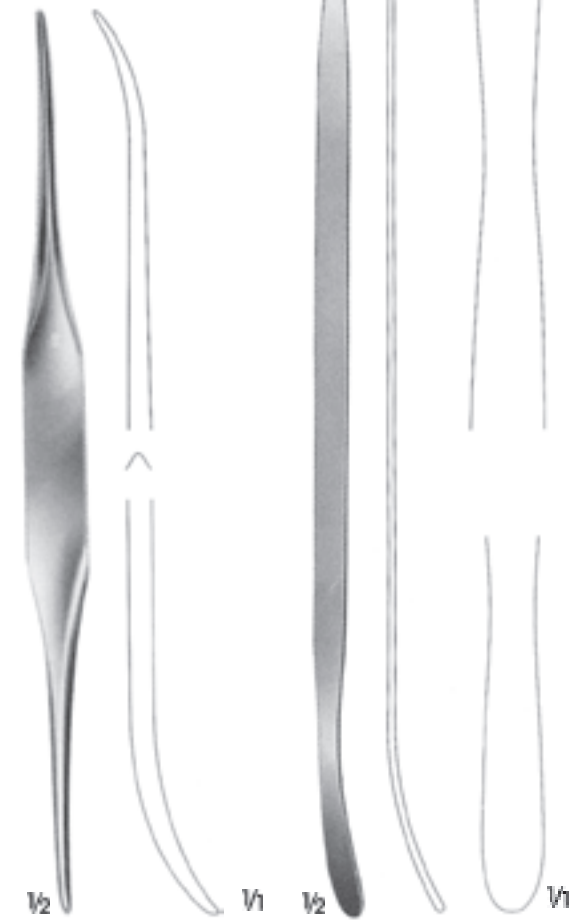

TÖENNIS
BN-2148
Oluklu disektör
Grooved dissector
24 cm

PENFIELD
BN-2108 Disektör/Dissector
Çif uçlu, hafif eğri
Double-ended, slightly curved
29 cm



COTTLE
BN-2139
Sivri/Sharp
Sivri/Sharp
Raspa/Raspatory
20 cm



COTTLE
BN-2142
Sivri/Sharp
Sivri/Sharp
Elavatör/Elavator
20 cm



PENNINGTON
BN-2143
Sivri/Sharp
Sivri/Sharp
Elavatör/Elavator
21 cm



PIERCE
BN-2144
Sivri/Sharp
Sivri/Sharp
Raspa/Raspatory
21 cm



HURD
BN-2206
Disektor/Dissector
21.5 cm



HURD
BN-2210
Disektor/Dissector
21.5 cm



HENKE
BN-2212
Disektor/Dissector
23.5 cm

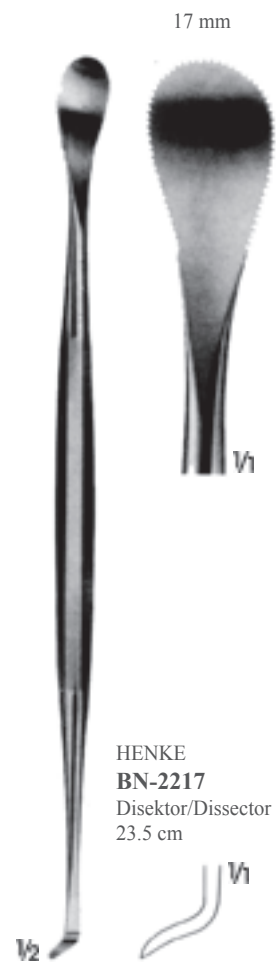

HENKE
BN-2217
Disektor/Dissector
23.5 cm

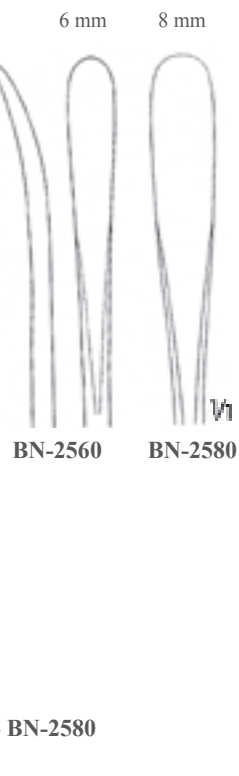
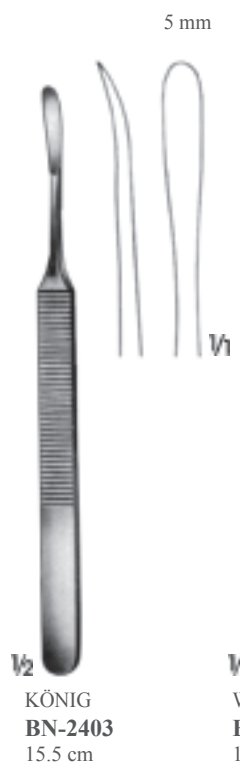
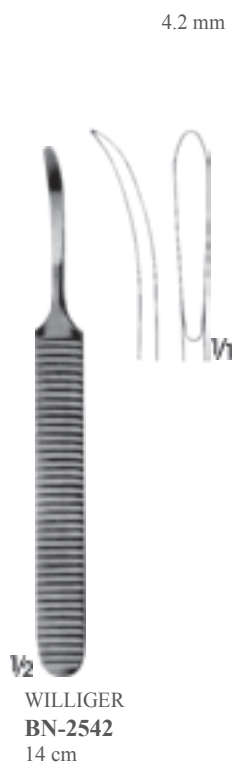

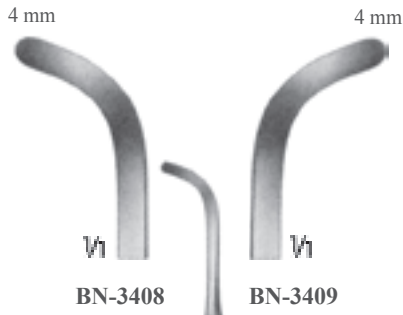

BN-3408 - BN-3409
14 cm



**TRELAT
BN-2700**
15 cm



**JOSEPH
BN-2750**
17 cm

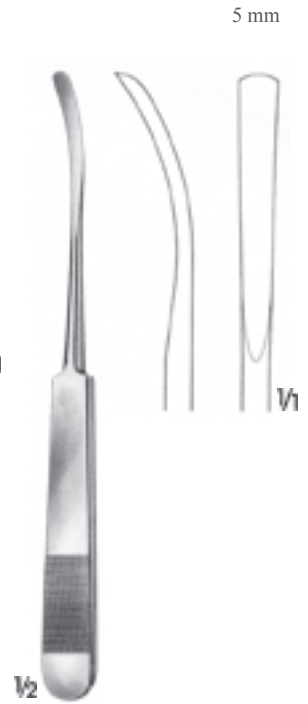

**ADSON
BN-3330**
16.5 cm



**LEMPERT
BN-4800**
Künt/Blunt
16.5 cm



**PENNYBAKER
BN-3335**
Künt/Blunt
16.5 cm

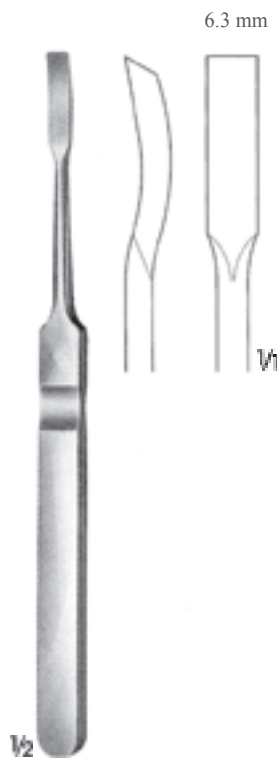

**LEMPERT
BN-3550**
Yarı sivri/Semi-sharp
18.5 cm



**ALLEN
BN-5245**
Osteofit çizil ve raspa
Osteophyte chisel and scraper
23 cm





MANNERFELT
BN-3000 - BN-3102
15.5 cm



BN-3000
4 mm
90°



BN-3001
6 mm
90°



BN-3002
3.5 mm
45°



BN-2800
3 mm



BN-2801
6 mm

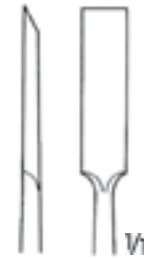

BN-2802
6 mm



BN-2900
4 mm



BN-2901
5 mm



BN-2902
6 mm



BN-2903
6 mm



BN-2904
8 mm



BN-3100
4 mm



BN-3101
7 mm



BN-3102
9 mm



PAULSEN
BN-3301 - BN-3302
20.5 cm



BN-3301
Sivri/Sharp



BN-3302
Sivri/Sharp



PAULSEN
BN-3303 - BN-3305
20.5 cm



BN-3303



BN-3304



BN-3305

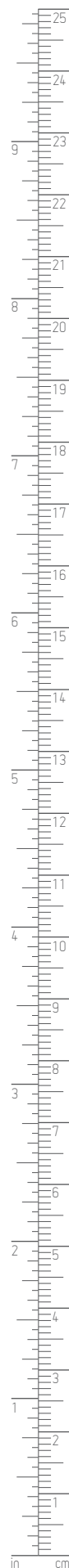
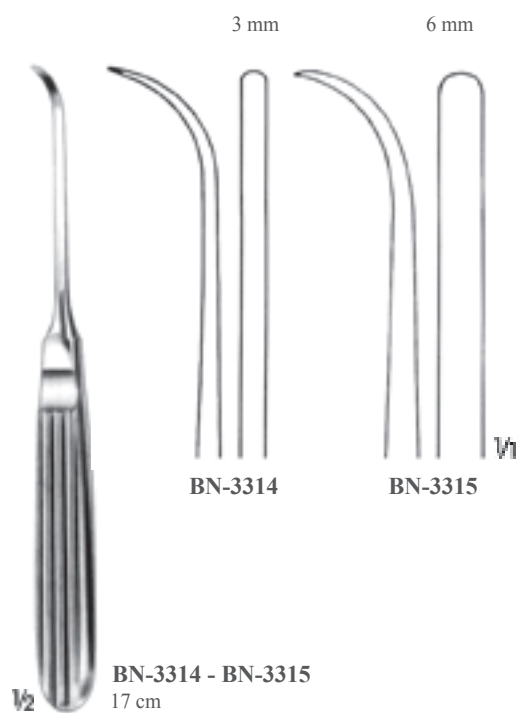
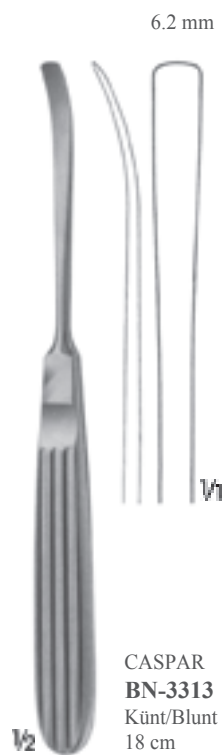
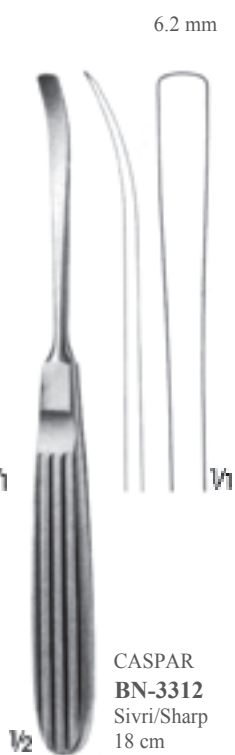
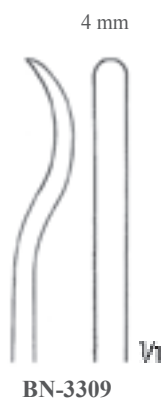

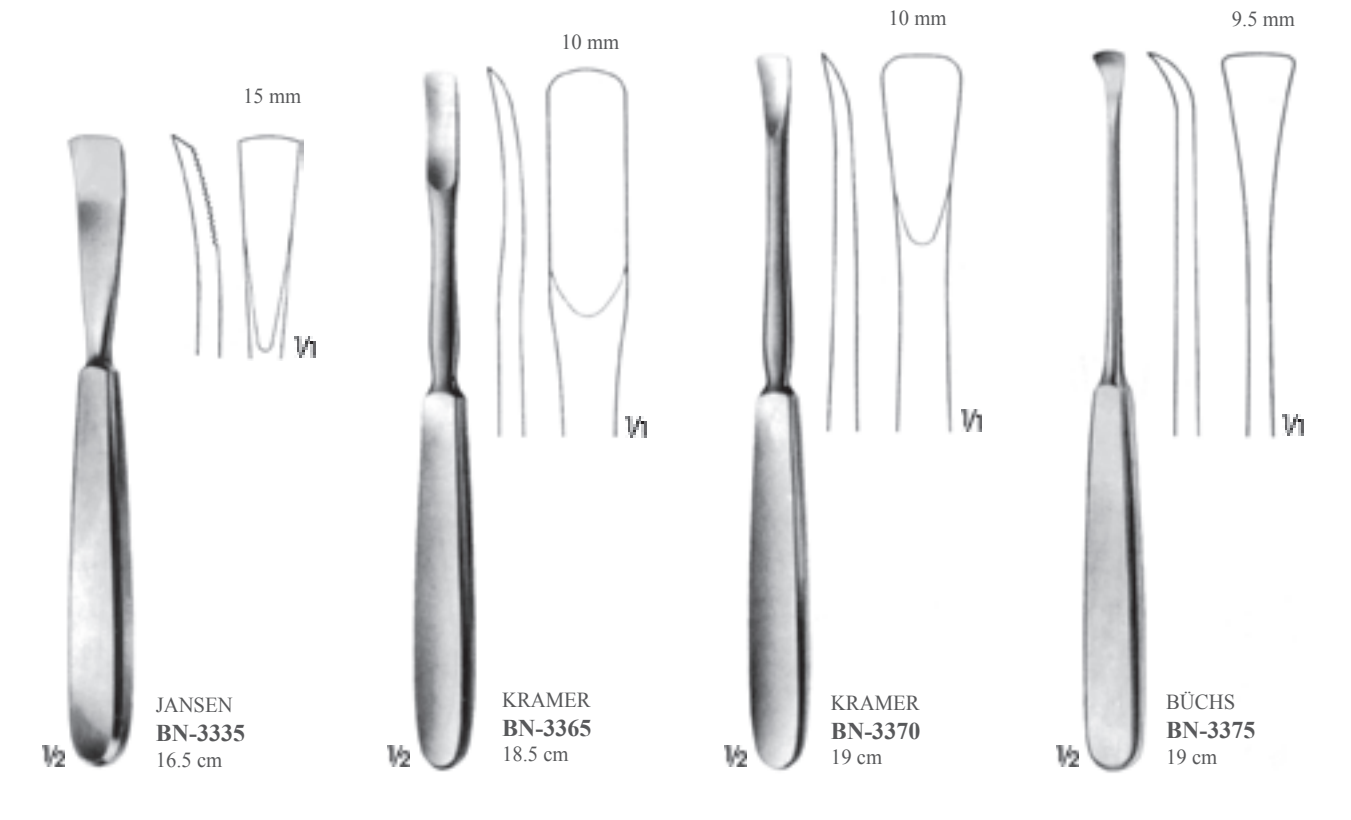
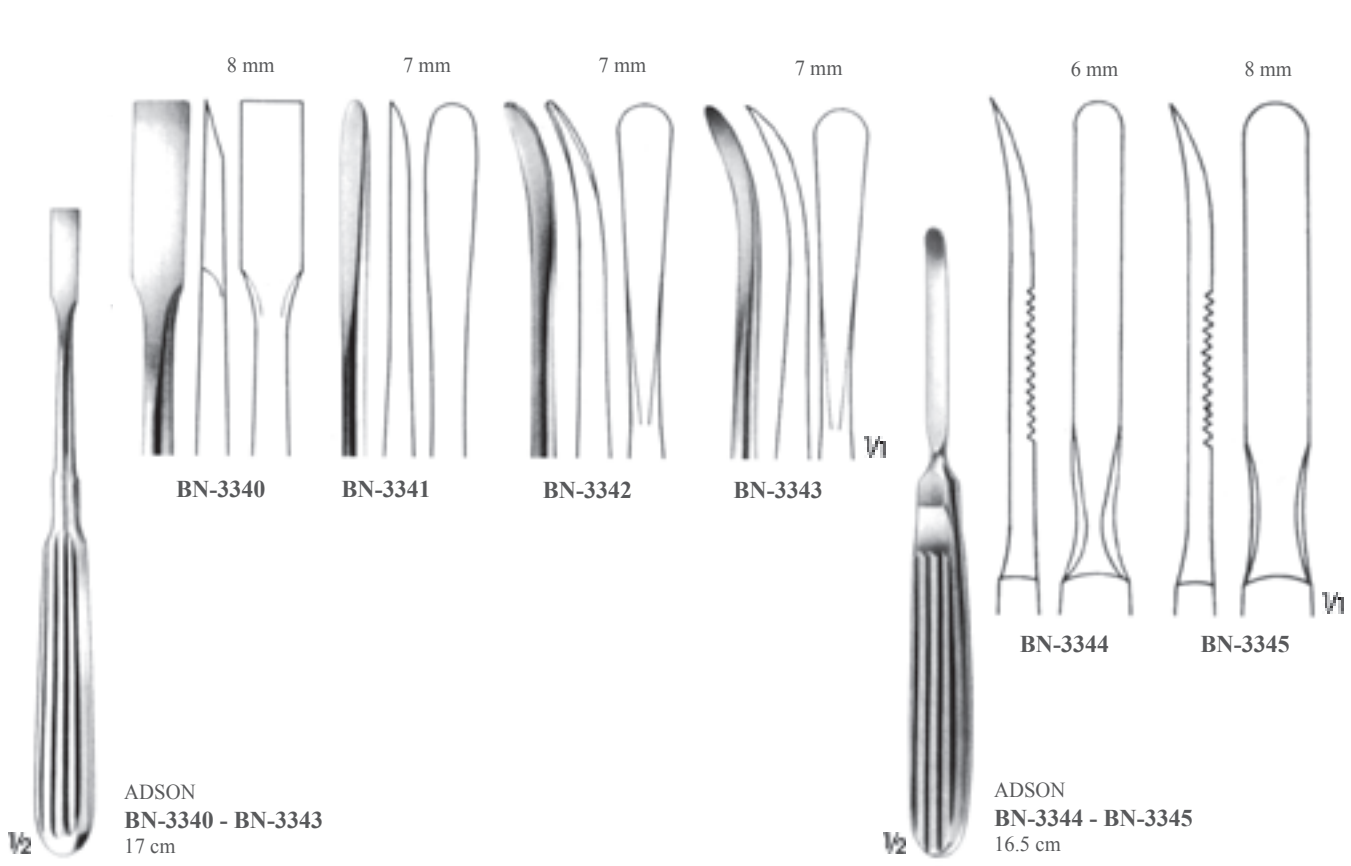

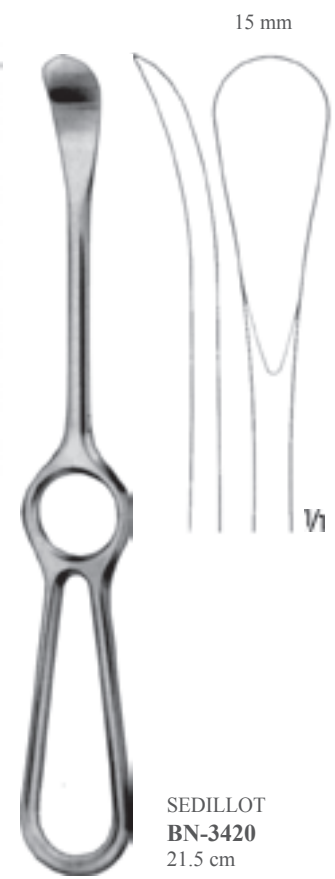
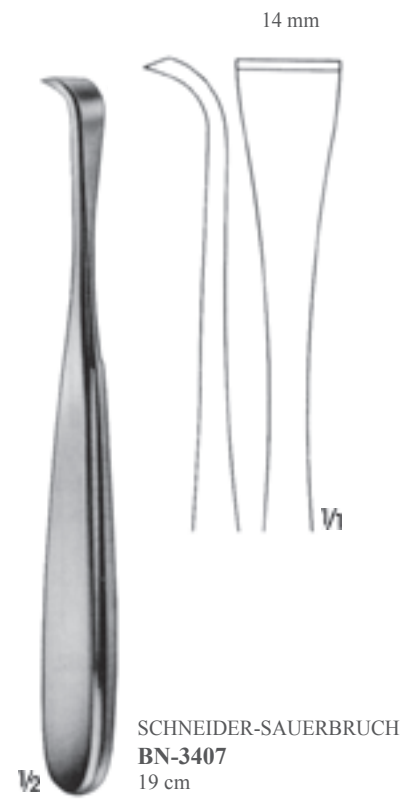

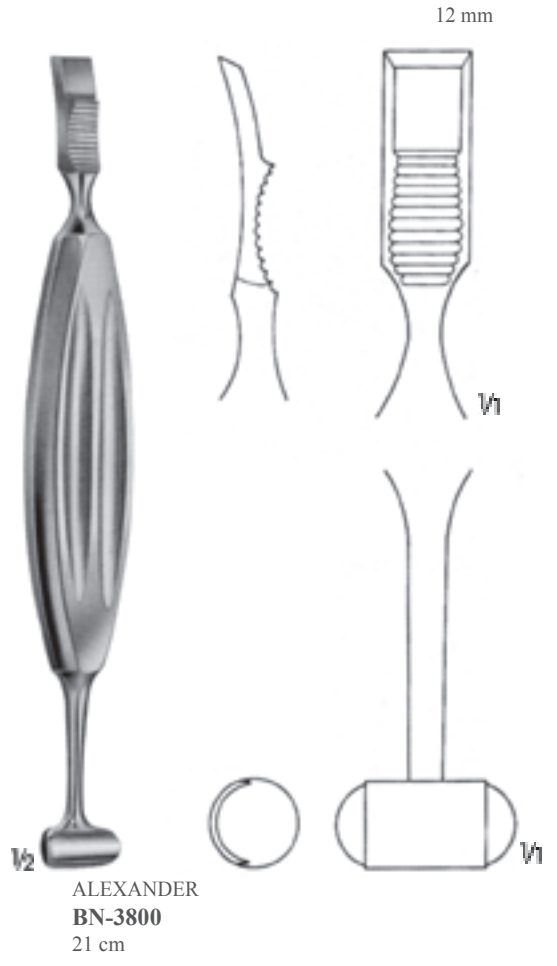
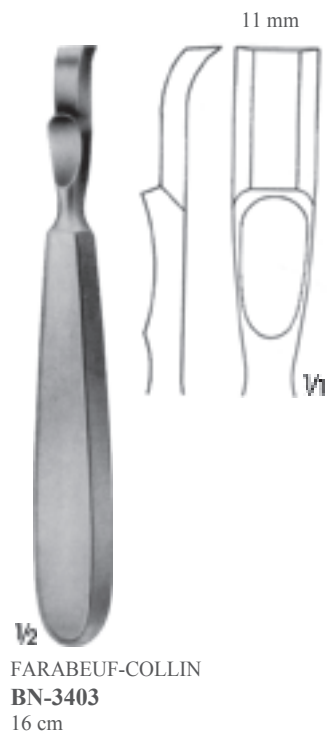
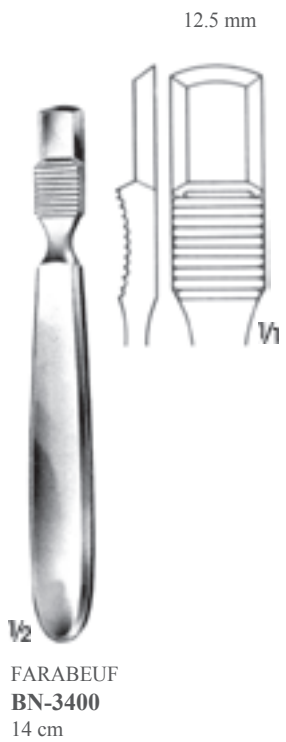

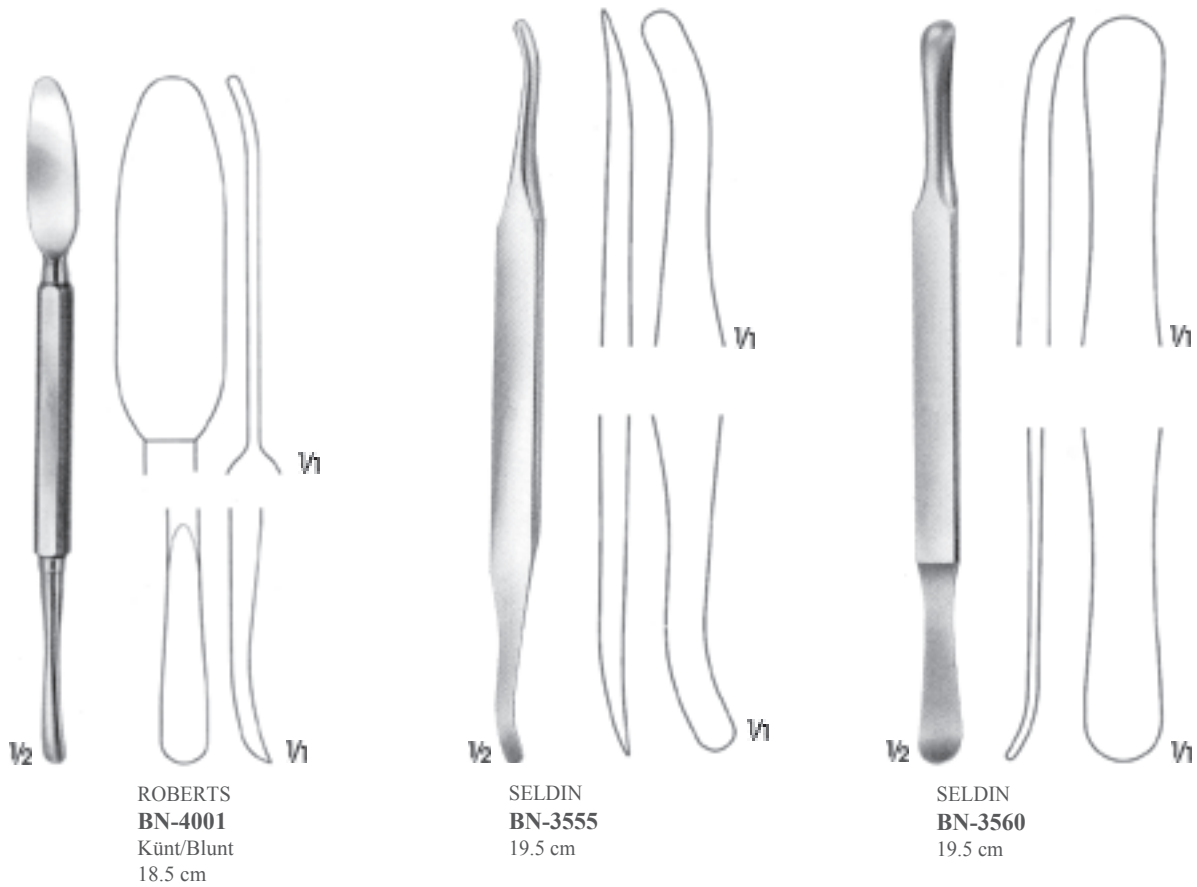
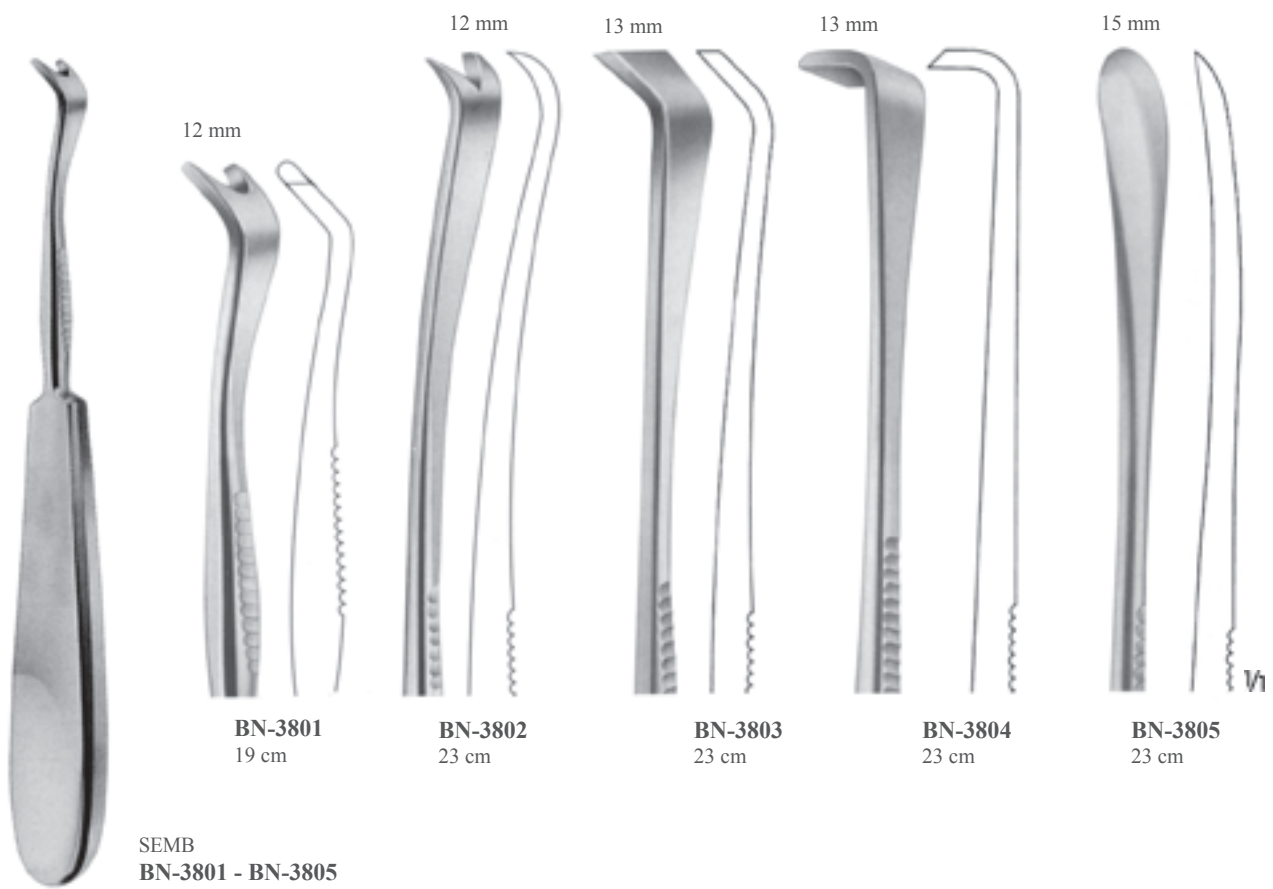

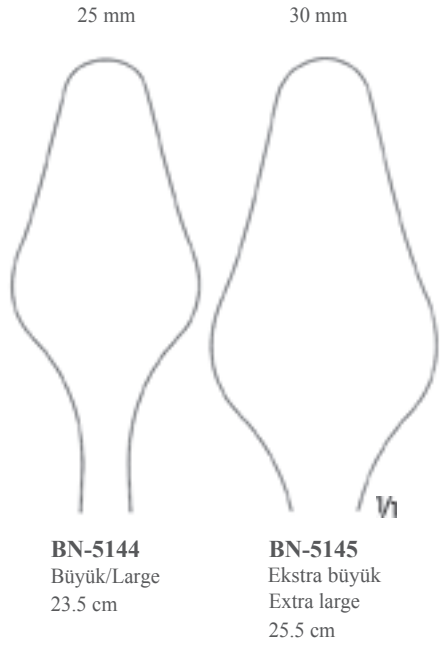
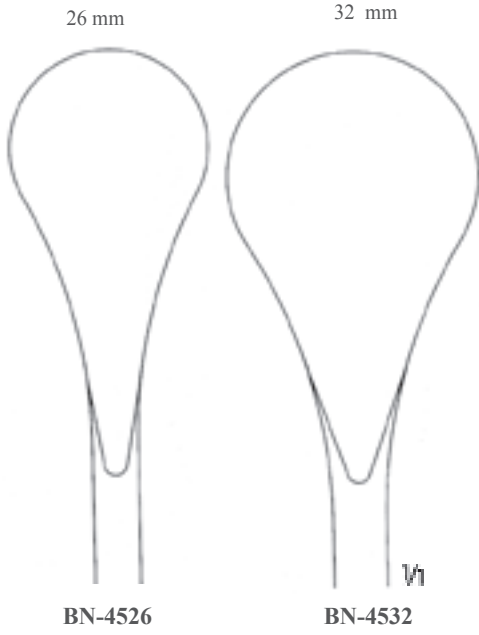
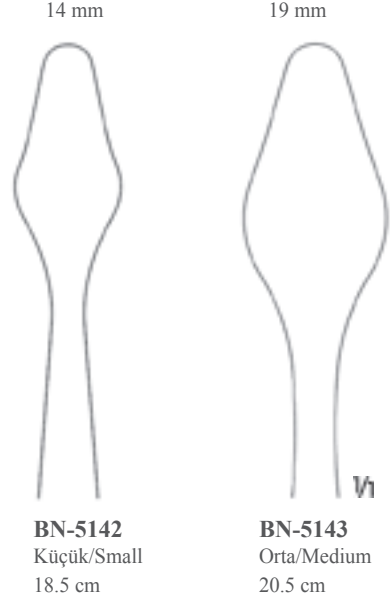
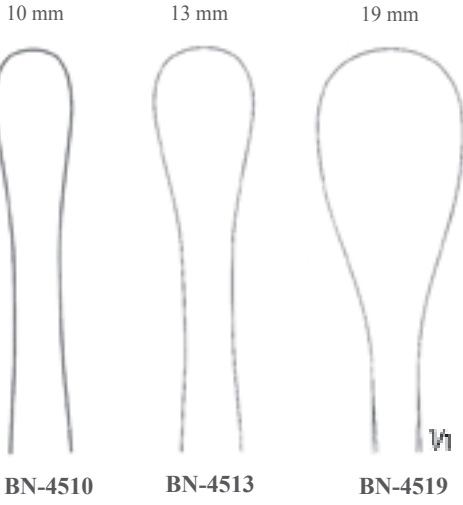

COBB
BN-4510 - BN-4532
Raspa/Raspatory
28 cm



CHANDLER
BN-5142 - BN-5145
Elevatörler/Elevators



19 mm



BN-4319

8 mm



BN-4408

13 mm



BN-4313

6 mm



BN-4406

10 mm



BN-4310

4 mm



BN-4404



KEY

BN-4200 - BN-4204

Genişlik
Width

Boy
Length

BN-4200	6 mm	18 cm
BN-4201	10 mm	19 cm
BN-4202	13 mm	19 cm
BN-4203	19 mm	20 cm
BN-4204	25 mm	21 cm



V2

COBB

BN-4310 - BN-4319

24 cm



V2

COBB

BN-4404 - BN-4408

27 cm



143° buhar sterilizörlerinde steril edilebilir.
Can be sterilized in a steam sterilizer up to 143°

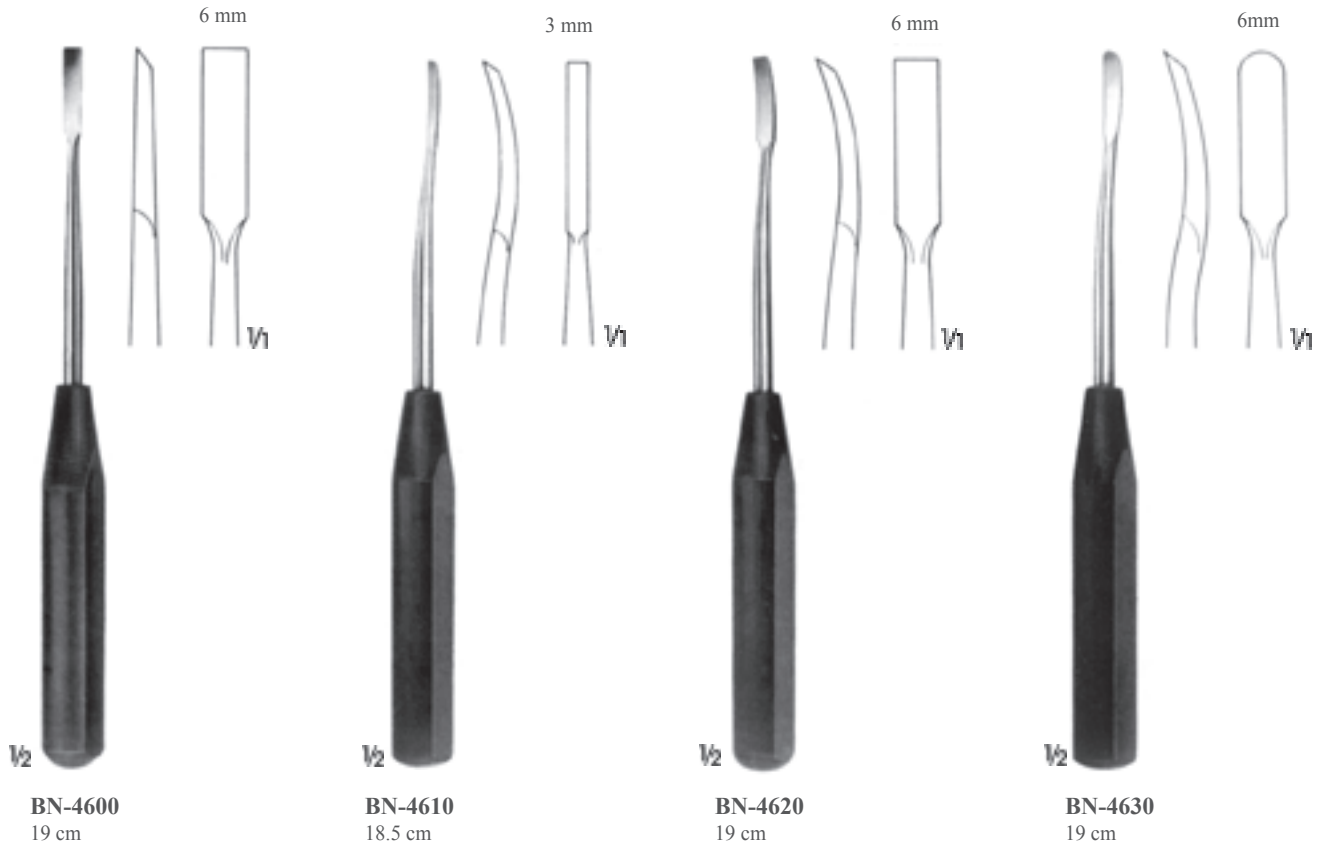

BN-4600
19 cm

BN-4610
18.5 cm

BN-4620
19 cm

BN-4630
19 cm

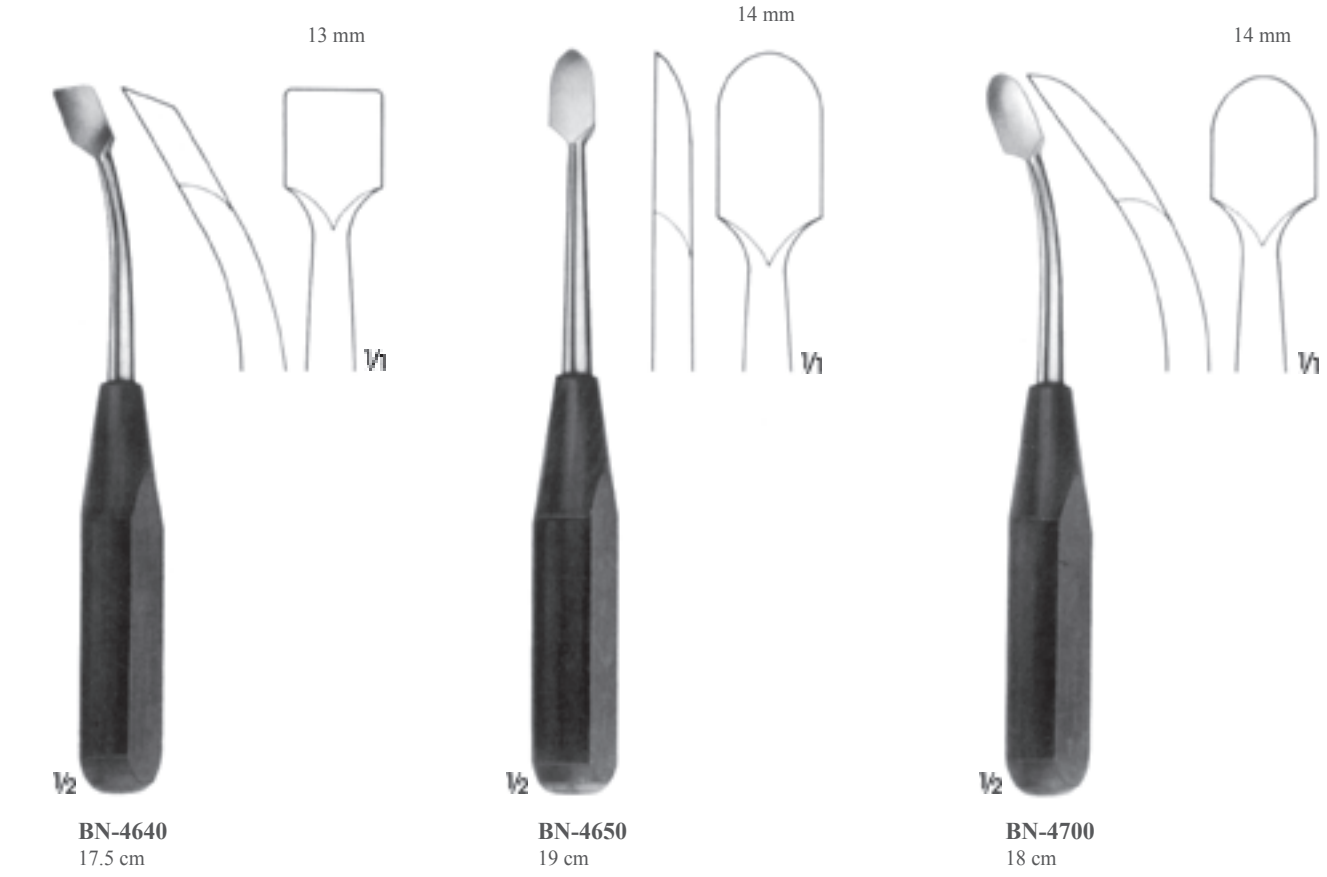

BN-4640
17.5 cm

BN-4650
19 cm

BN-4700
18 cm

143° buhar sterilizatörlerinde steril edilebilir.
Can be sterilized in a steam sterilizer up to 143°

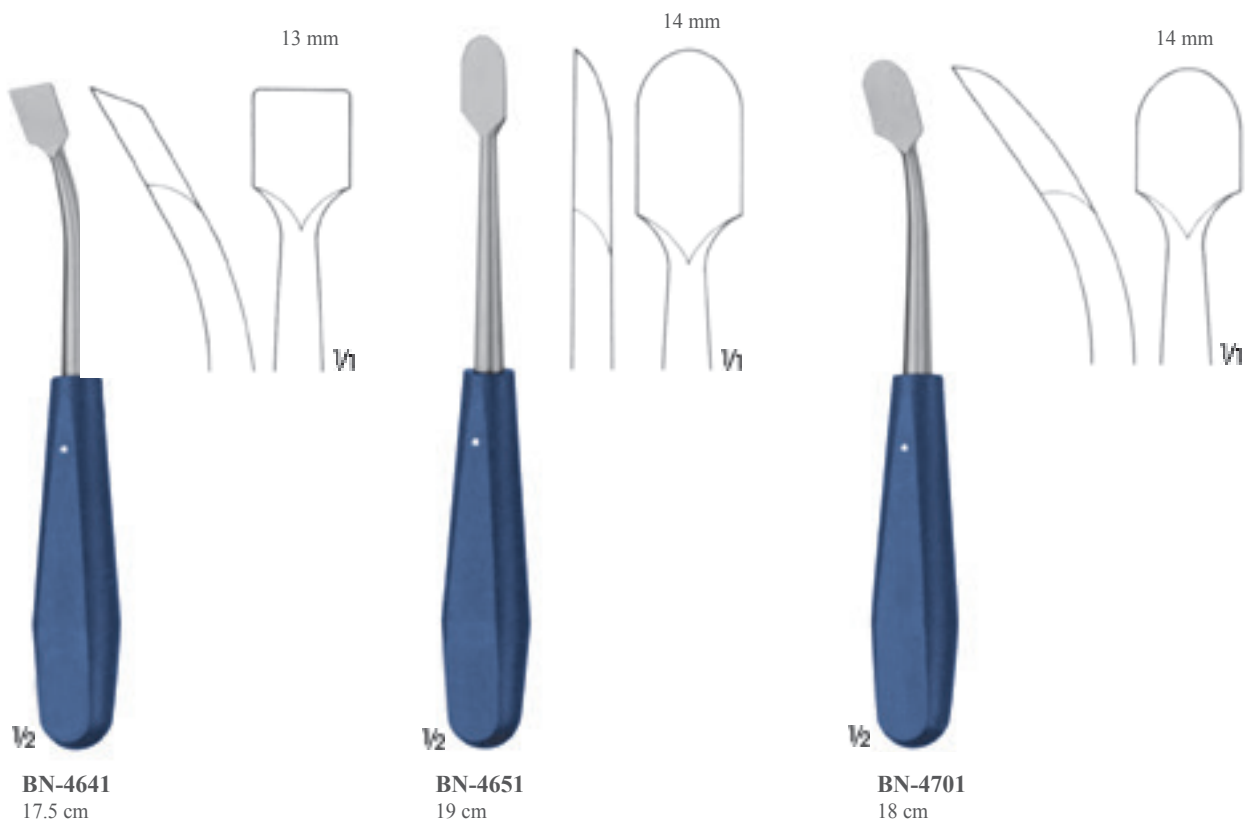
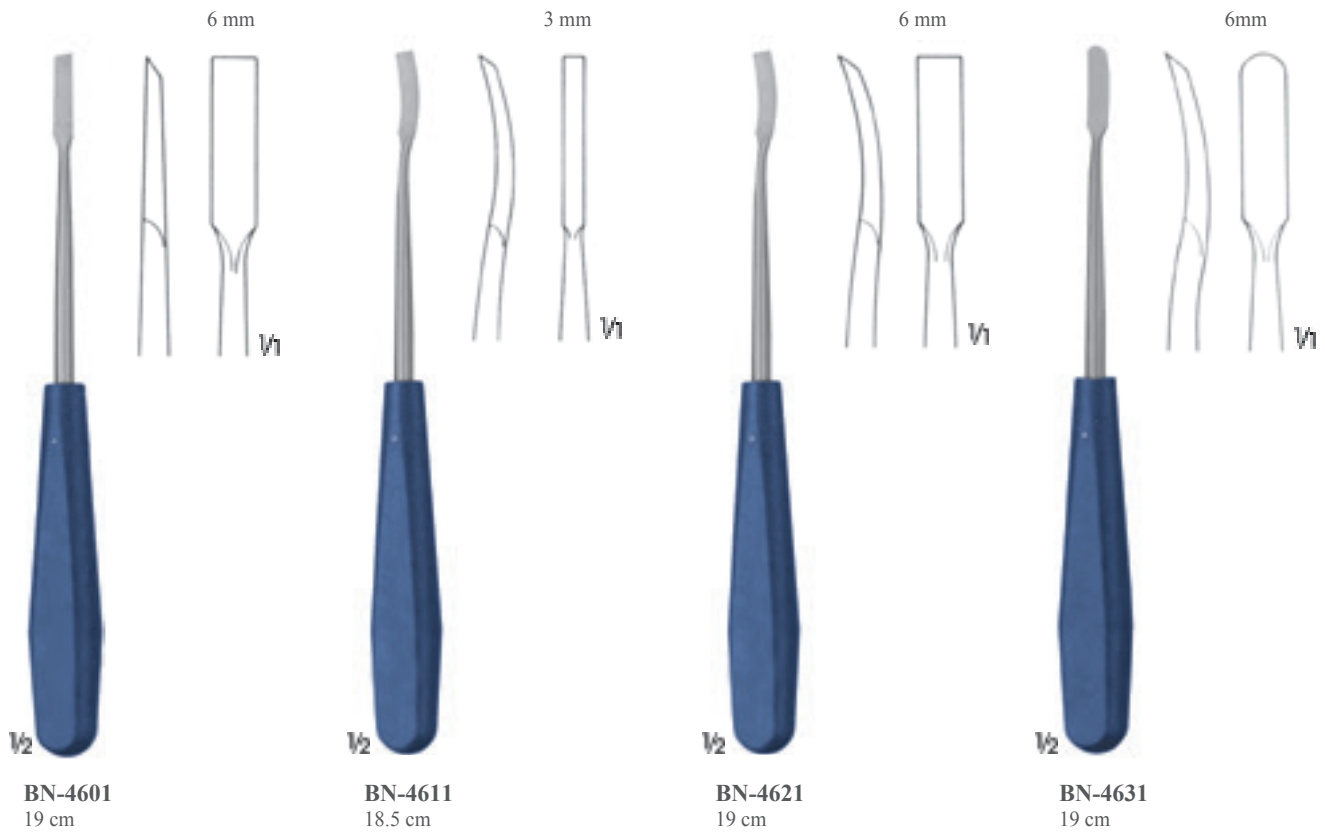



BN-3900

BN-3902

V2

DOYEN
BN-3900 - BN-3902
Çocuklar için/For children
17.5 cm

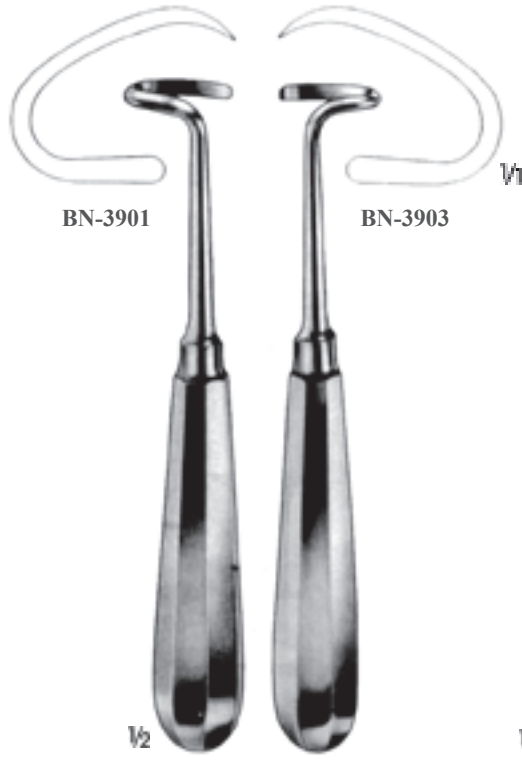

BN-3901

BN-3903

V2

DOYEN
BN-3901 - BN-3903
Yetişkinler için/For adults
17.5 cm

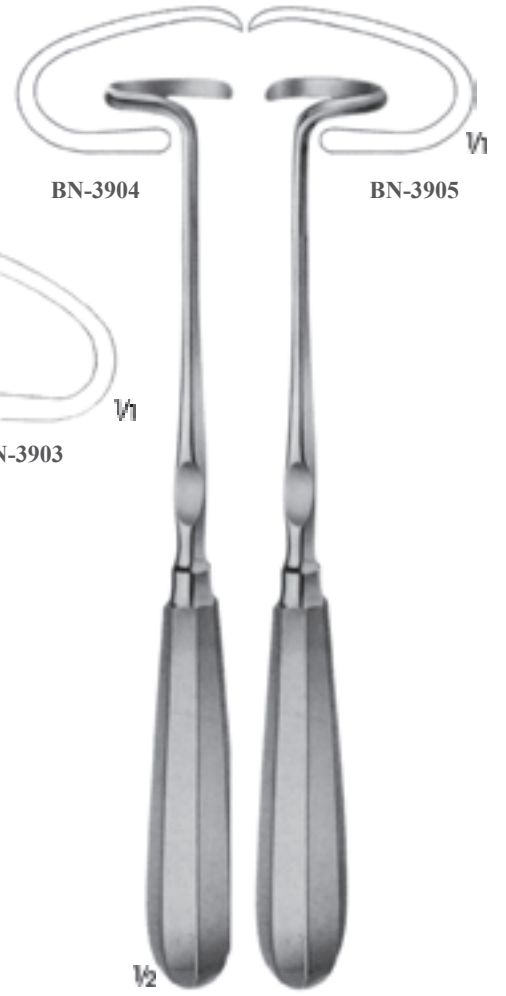

BN-3904

BN-3905

V2

DOYEN
BN-3904 - BN-3905
24 cm

143° buhar sterilizatörlerinde steril edilebilir.
Can be sterilized in a steam sterilizer up to 143°



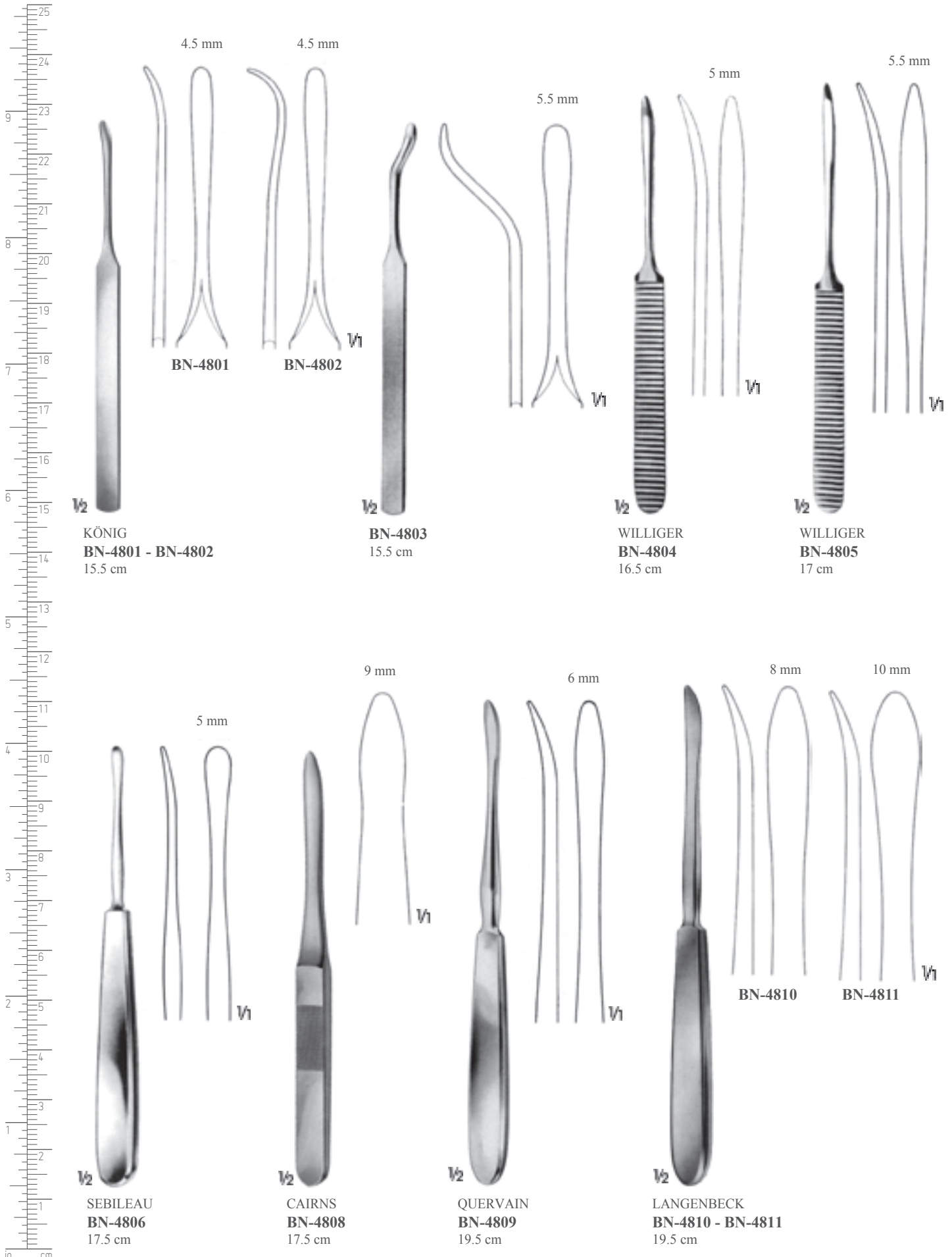

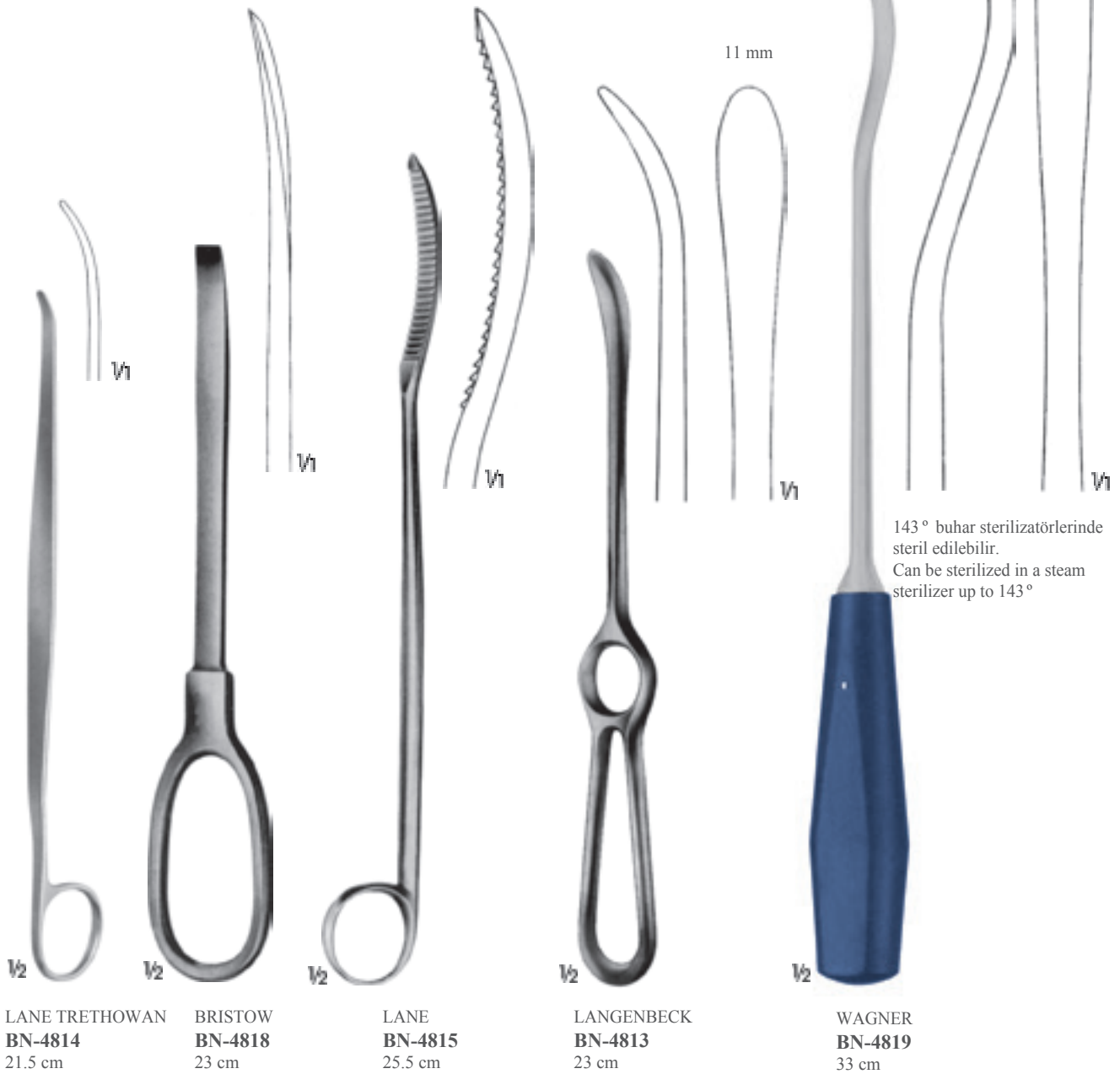

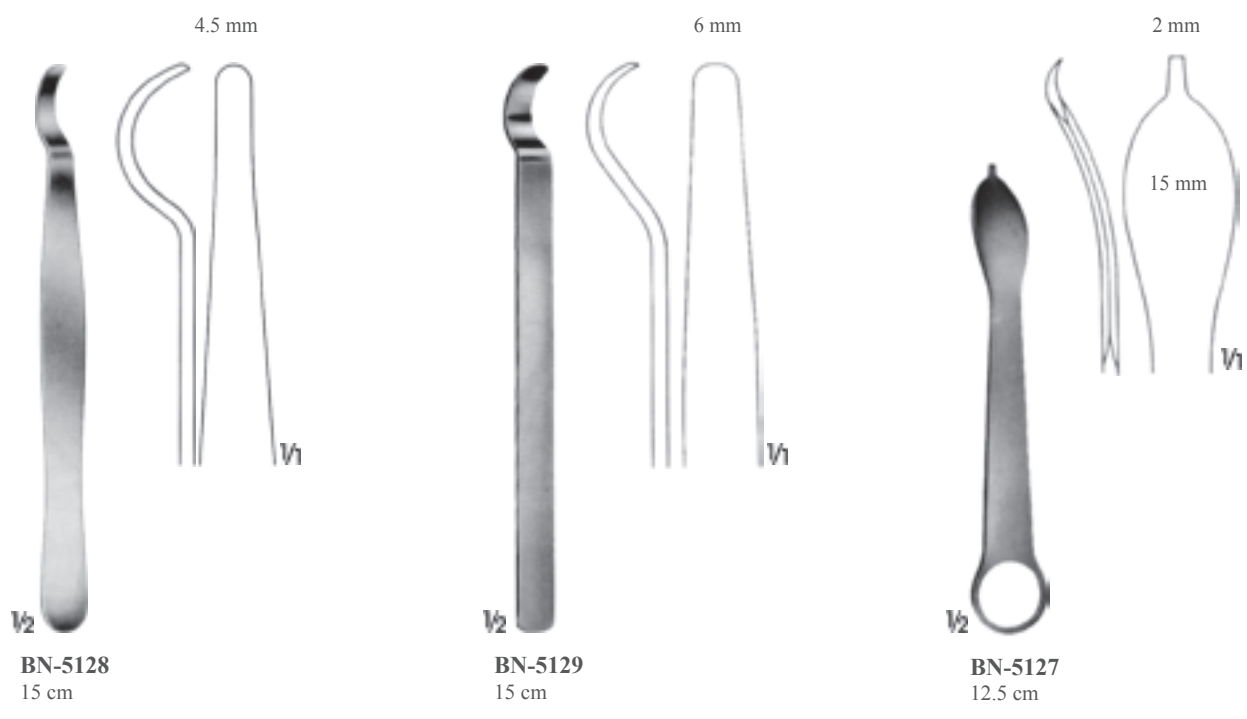
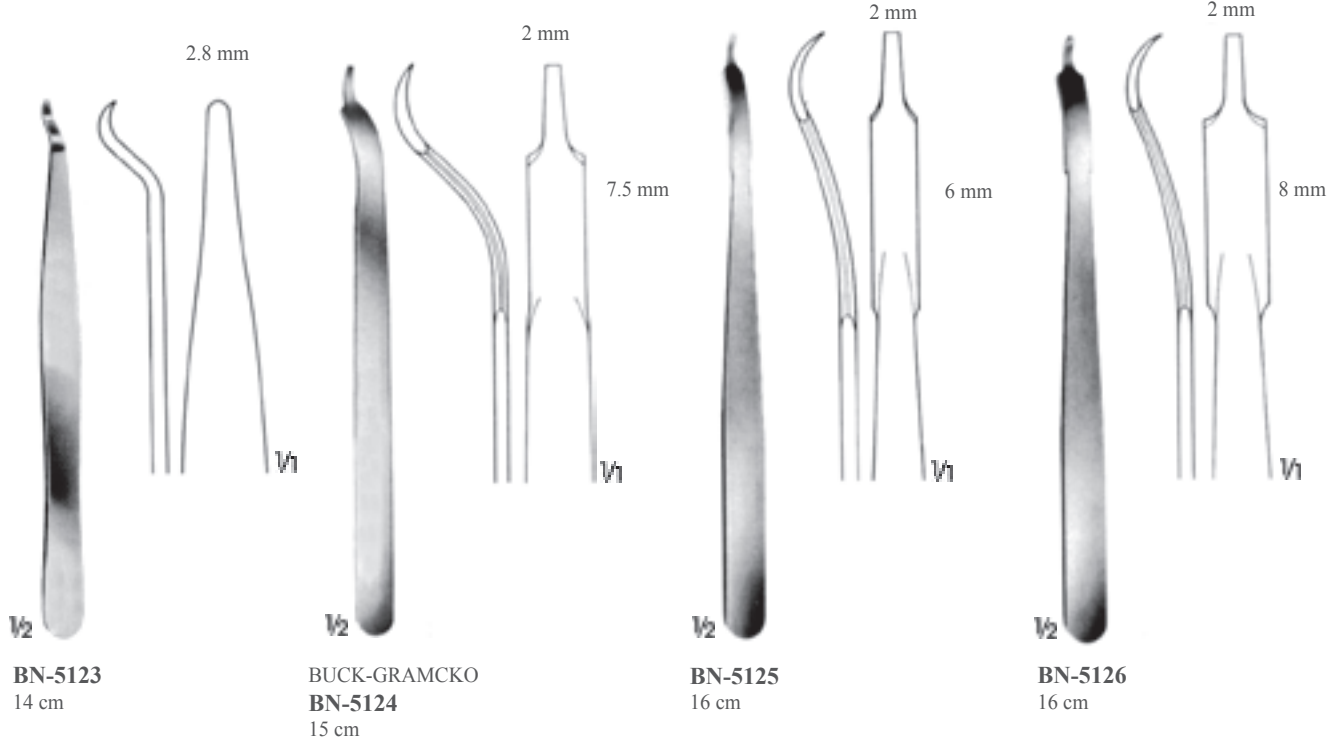

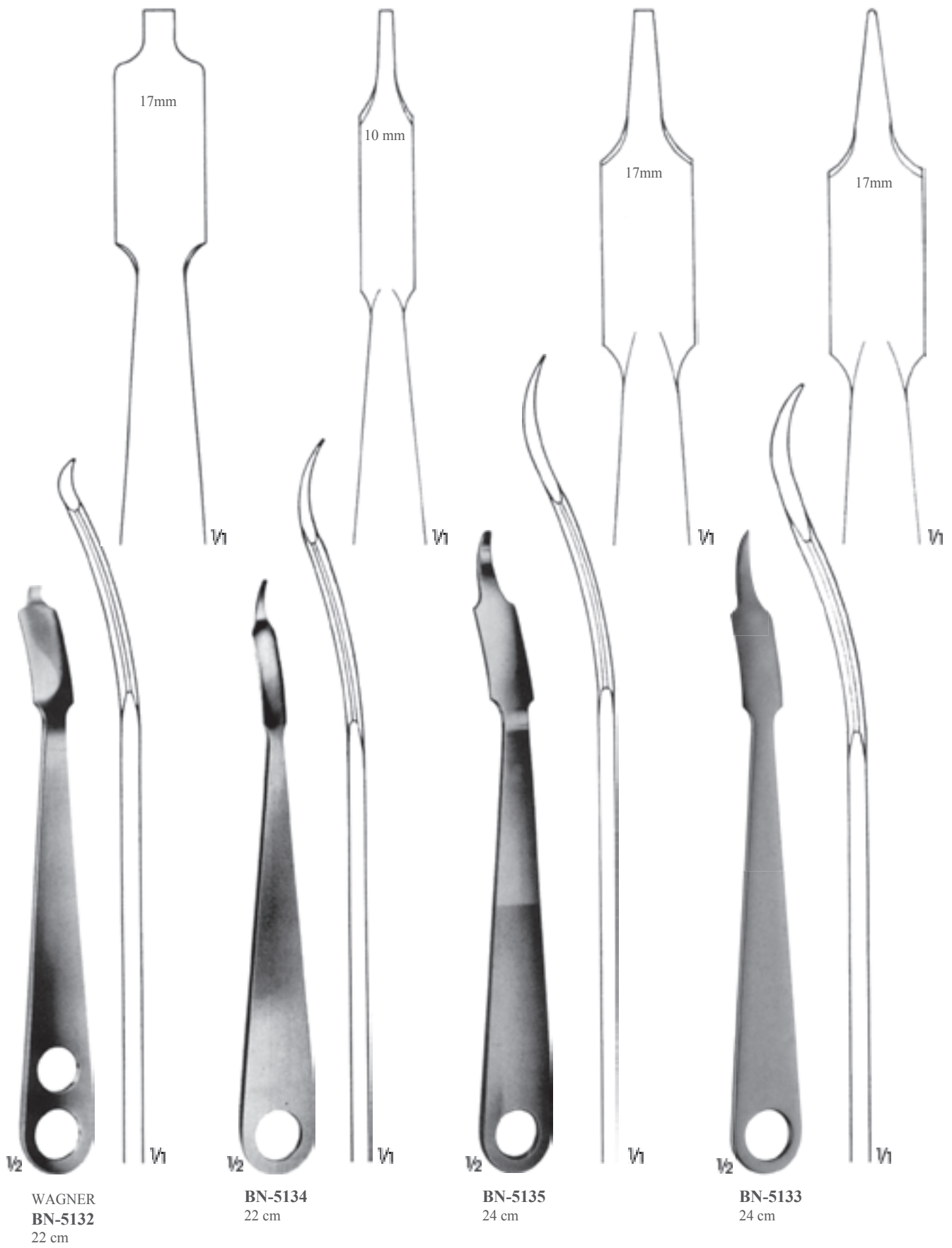



V₂
VATSON-JONES
BN-5130
28 cm

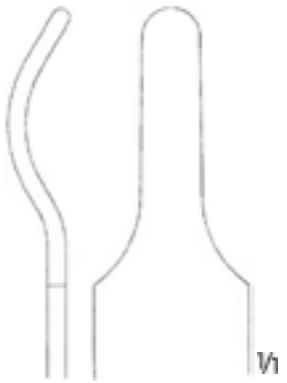

V₁



V₂
BN-5131
22 cm



8 mm

V₁

V₁



V₂
BN-5153
25 cm



15 mm

V₁

V₁

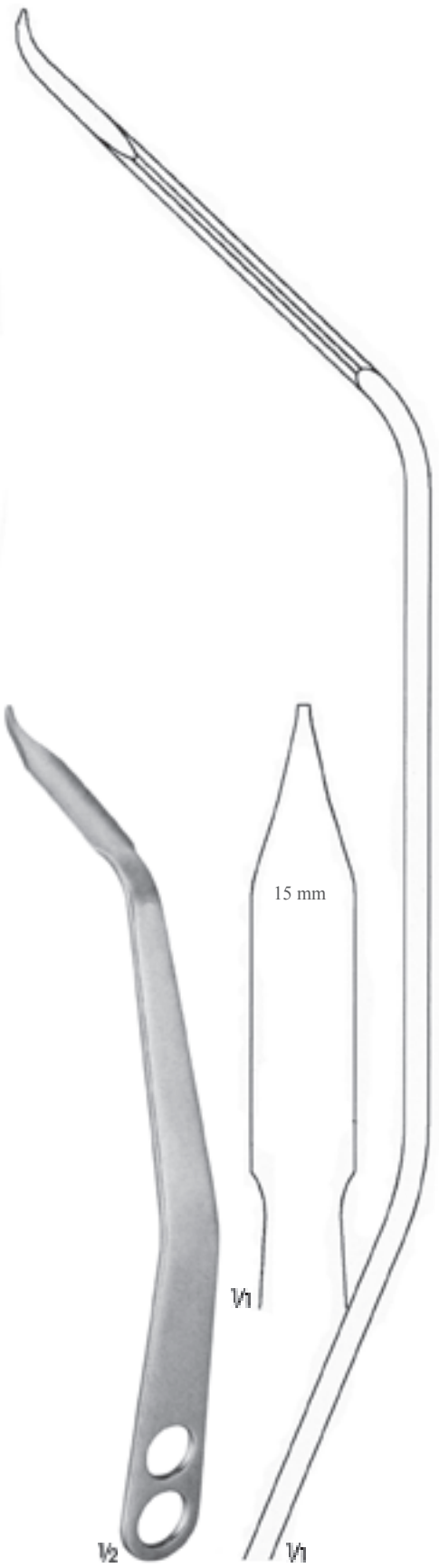

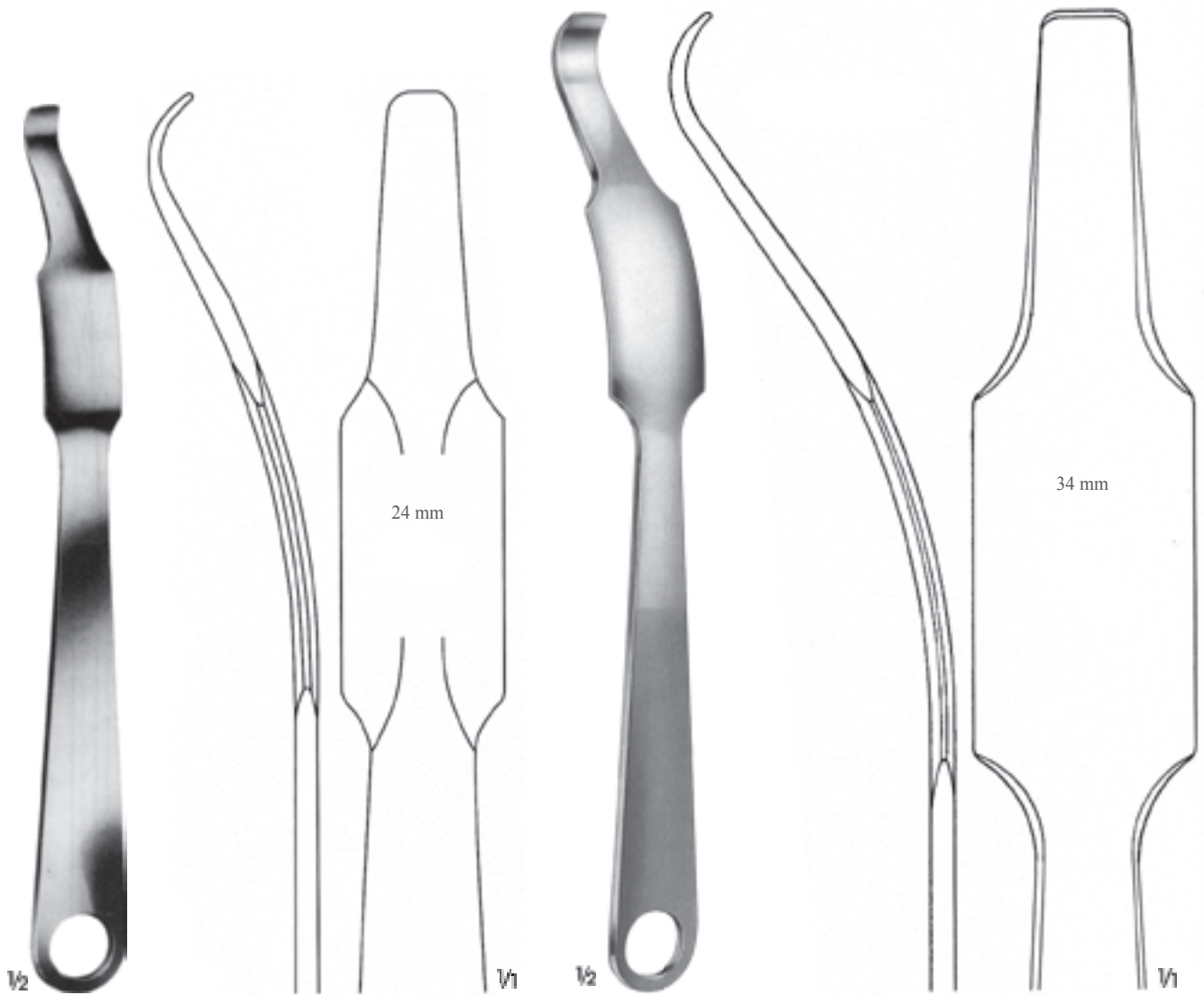

$\frac{1}{2}$
HOHMANN
BN-5136
26 cm

$\frac{1}{2}$
HOHMANN
BN-5137
28.5 cm

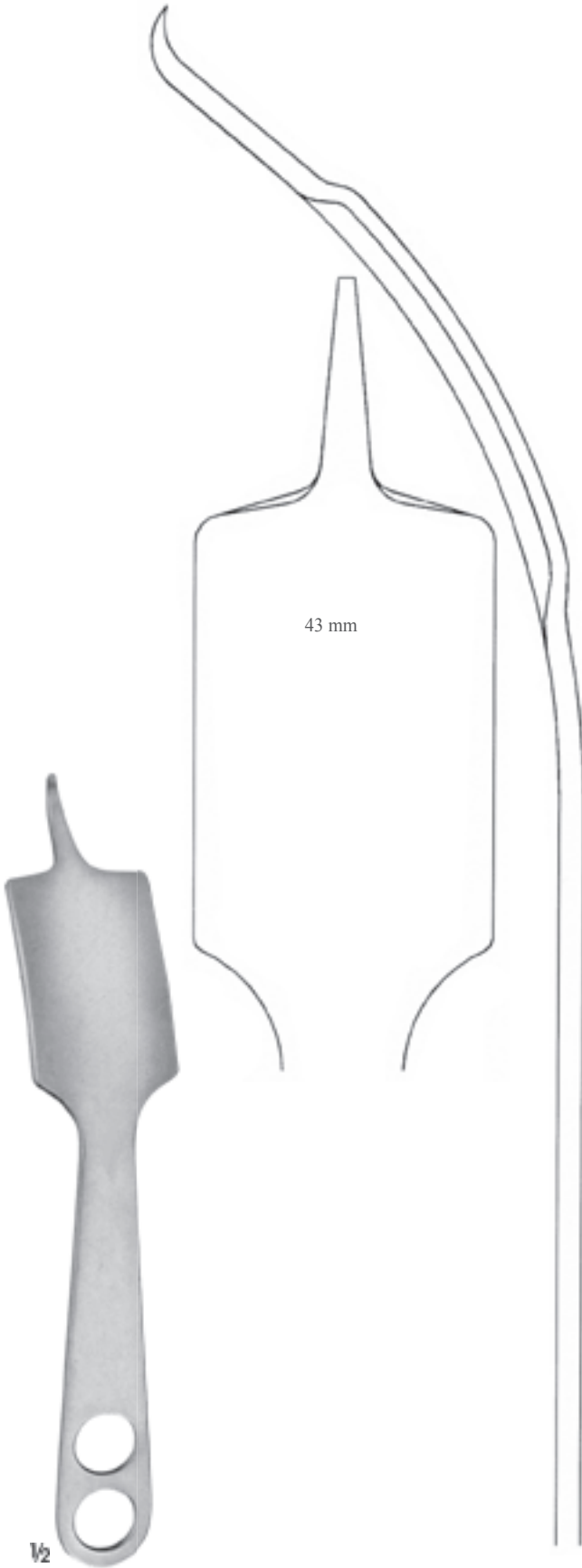

BN-5138
23 cm

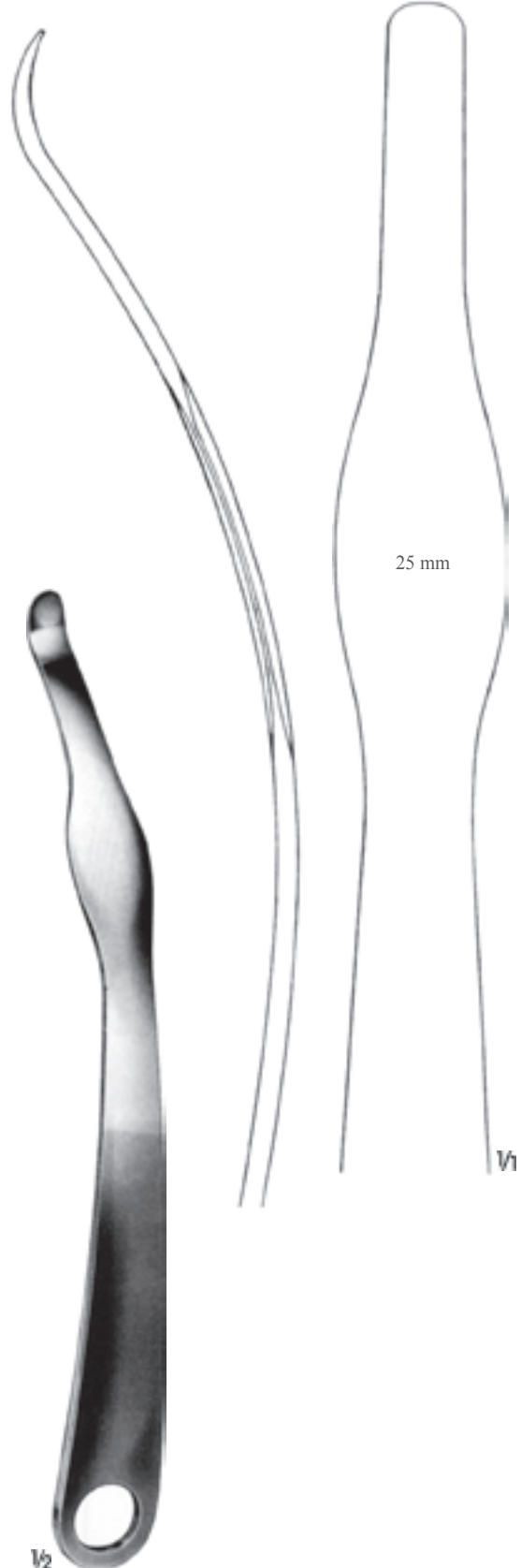

BN-5141
26 cm

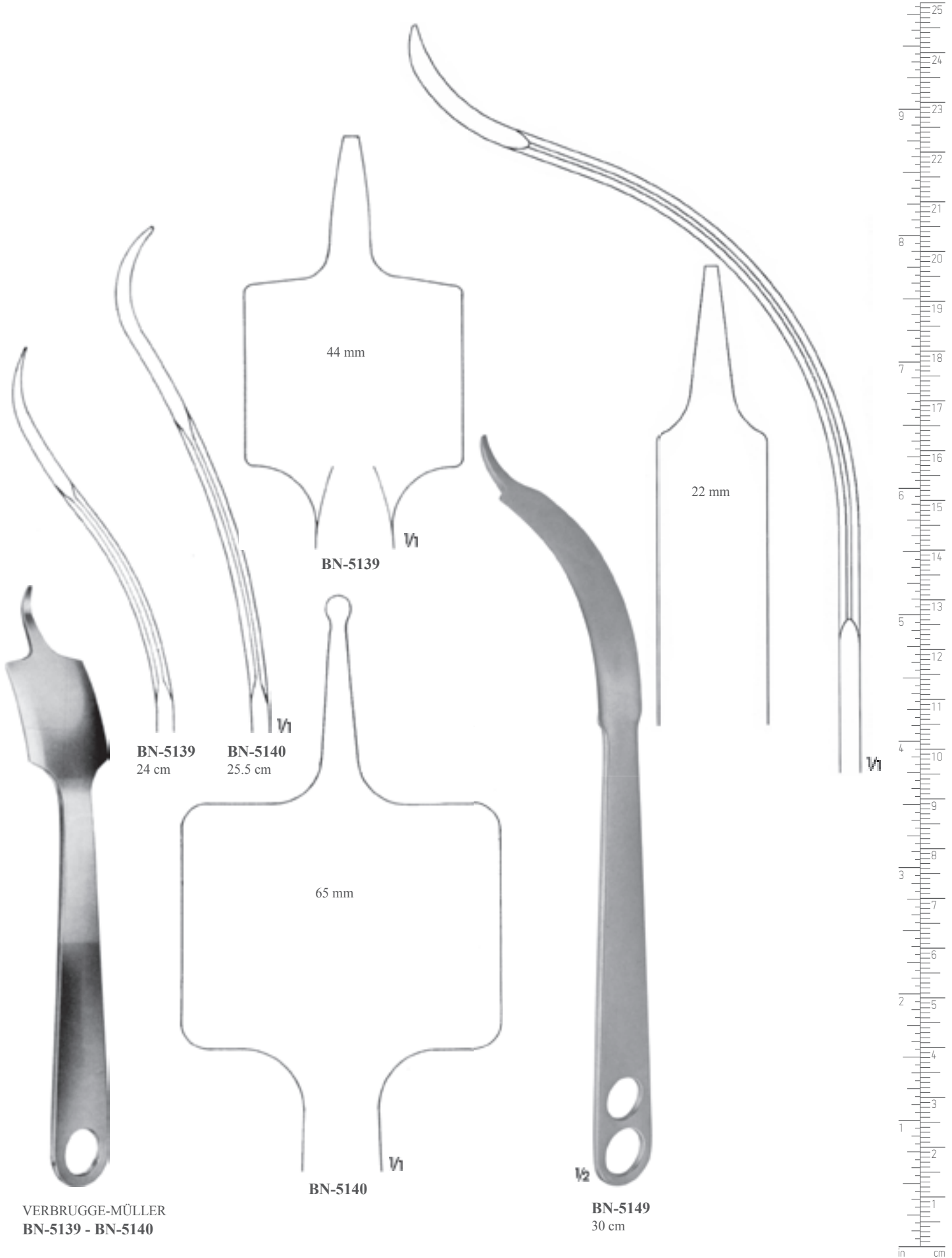

VERBRUGGE-MÜLLER
BN-5139 - BN-5140

BN-5149
30 cm

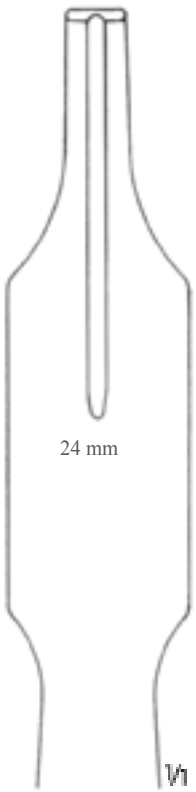

24 mm

W1



W2

LANGE-HOHMANN
BN-5146
25 cm



W1



W2

LANGE-HOHMANN
BN-5147 26.5 cm
BN-5148 28 cm

BN-5147
30 mm
BN-5148
33 mm

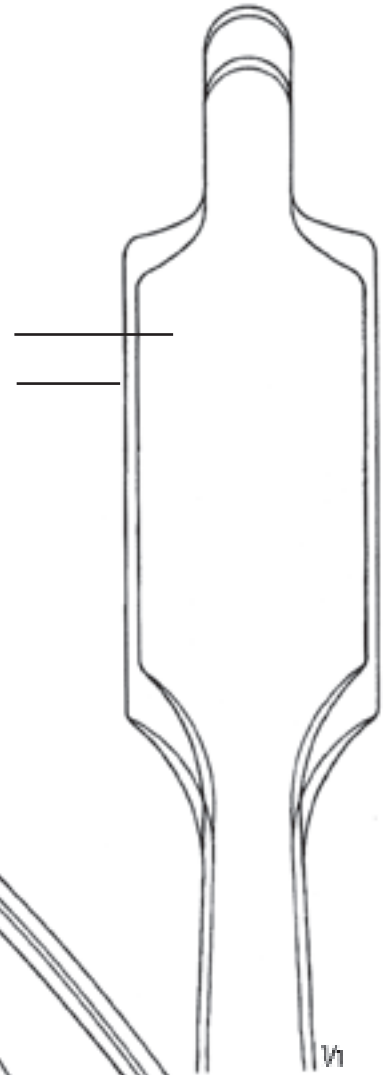

BN-5147

BN-5148

W1

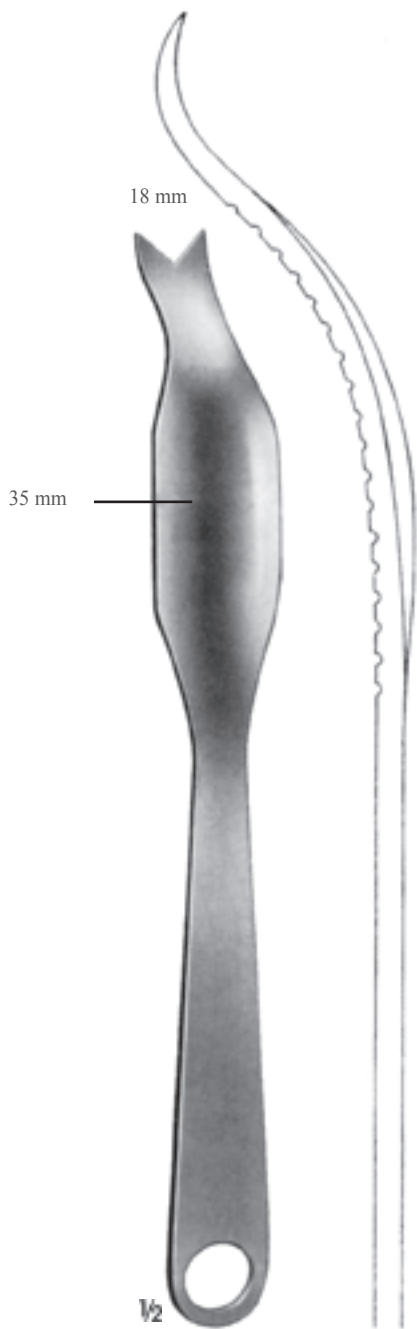

SCHUMACHER
BN-5150
29 cm



Arka görünüm
Reverse side



SCHUMACHER-WAGNER
BN-5151
35.5 cm





40 mm

BN-5154
32 cm



40 mm

BN-5156
32 cm



26 mm

BN-5159
Femur ekartörü
Femoral retractor
38 cm



BENNETT
BN-5160 25 mm-44 mm
BN-5161 25 mm-65 mm
23.5 cm

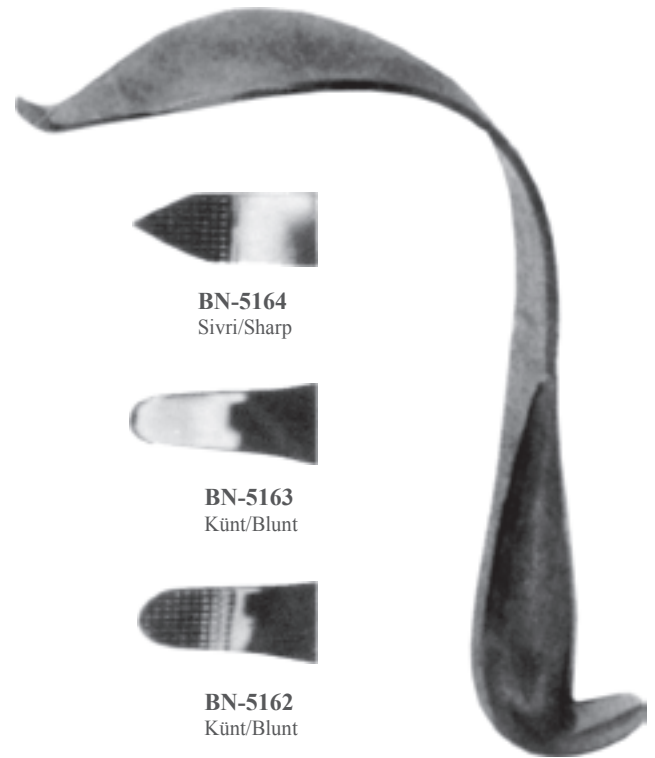

COBRA
BN-5162 - BN-5164
28 cm





24 mm

V1



V2

HOHMANN-ALDINGER
BN-5152
27 cm

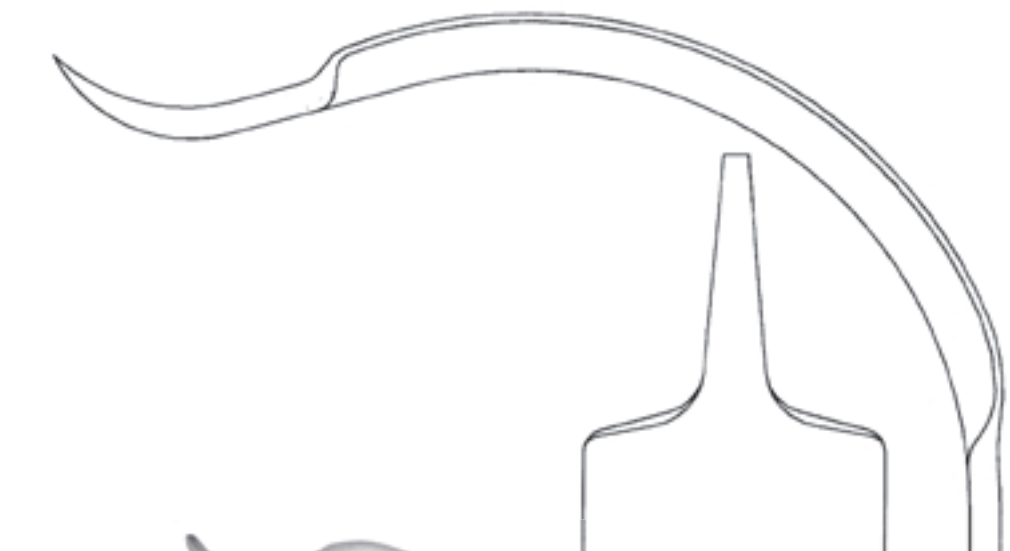

40 mm

V1



V2

BN-5155
29 cm



V1

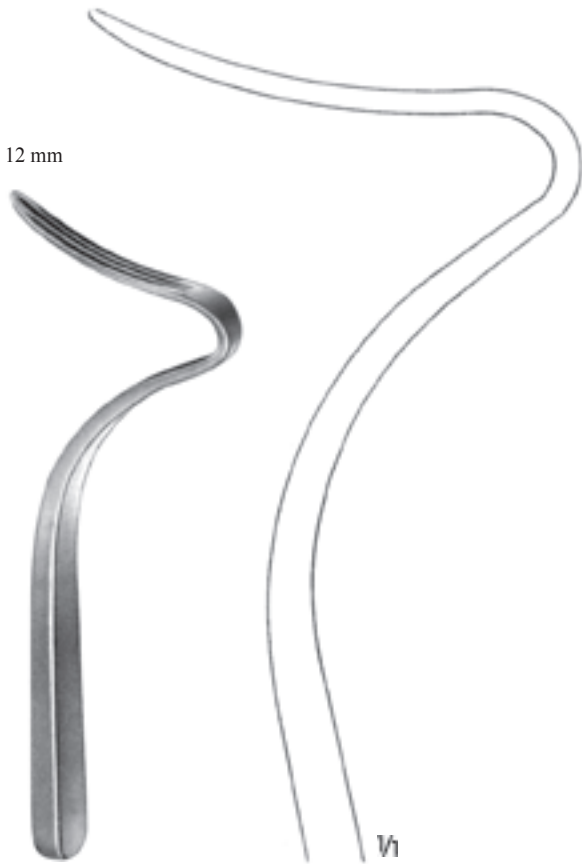

TAGER
BN-5165
Mafsal elevatör
Bone lever for angle joint operations
17.5 cm



BLOUNT
BN-5158
27 cm

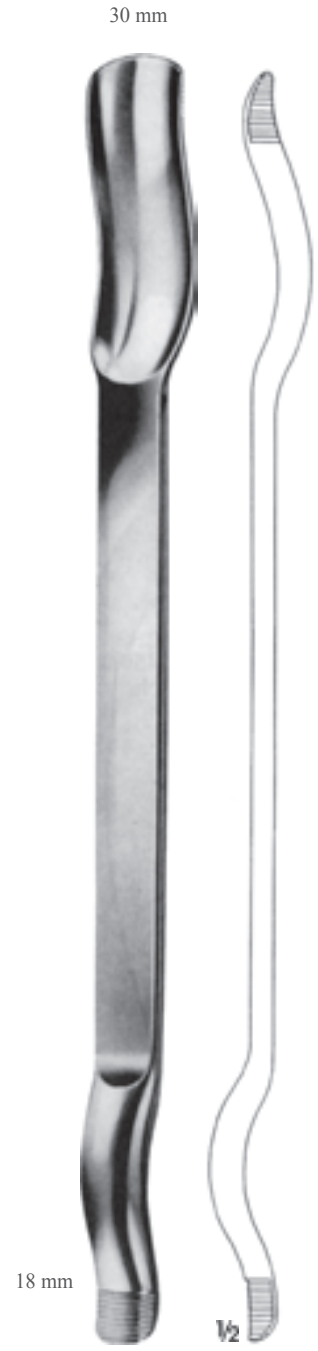

MURPHY-LANE
BN-5166
Luksasyon elevatörü
Luxation lever
33 cm



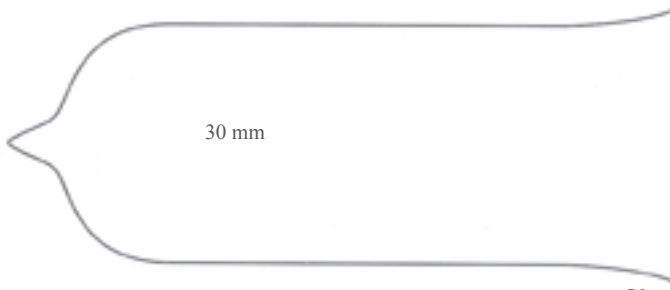

30 mm

70/100 mm

1/1

TAYLOR
BM-2410 30 x 70 mm
18.5 cm
BM-2411 30 x 100 mm
20 cm



1/2

HIBBS
BK-2980 - BK-2982
23.5 cm



BK-2982
25 x 75 mm



BK-2981
20 x 50 mm



BK-2980
13 x 25 mm

90°

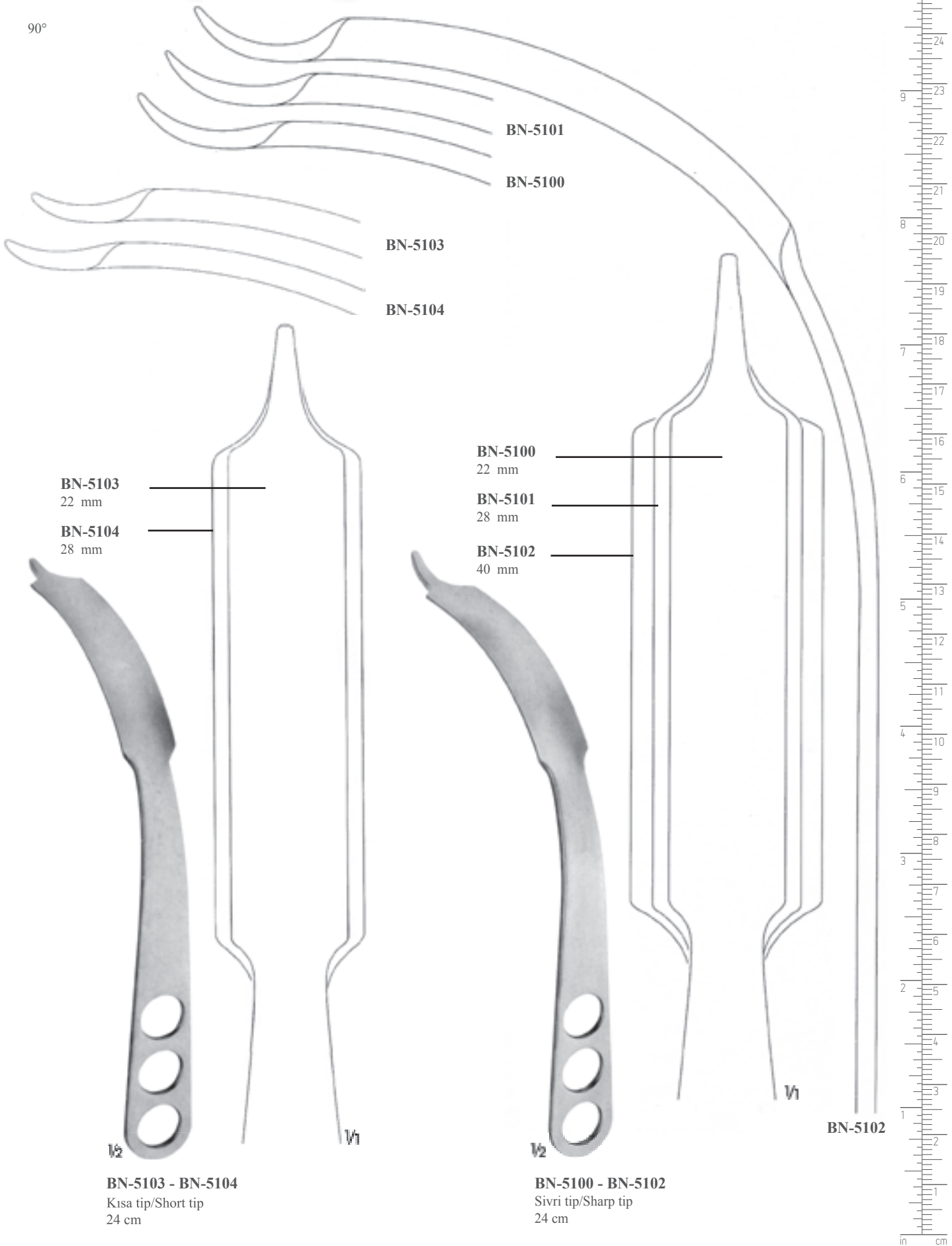



90°

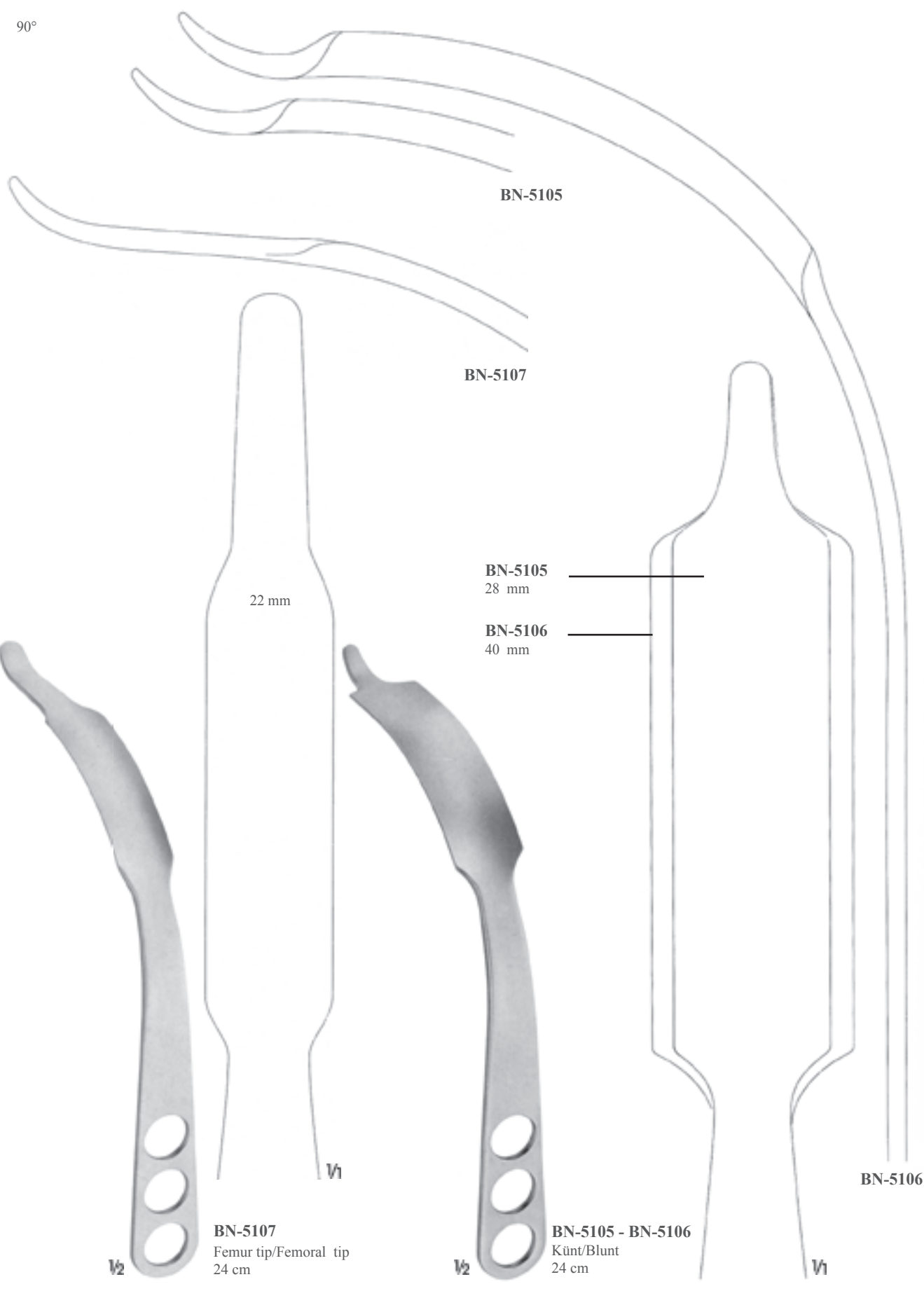

BN-5105

BN-5107

22 mm

BN-5105
28 mm

BN-5106
40 mm

BN-5106

W2

BN-5107
Femur tip/Femoral tip
24 cm

W2

BN-5105 - BN-5106
Künt/Blunt
24 cm

W1

45°

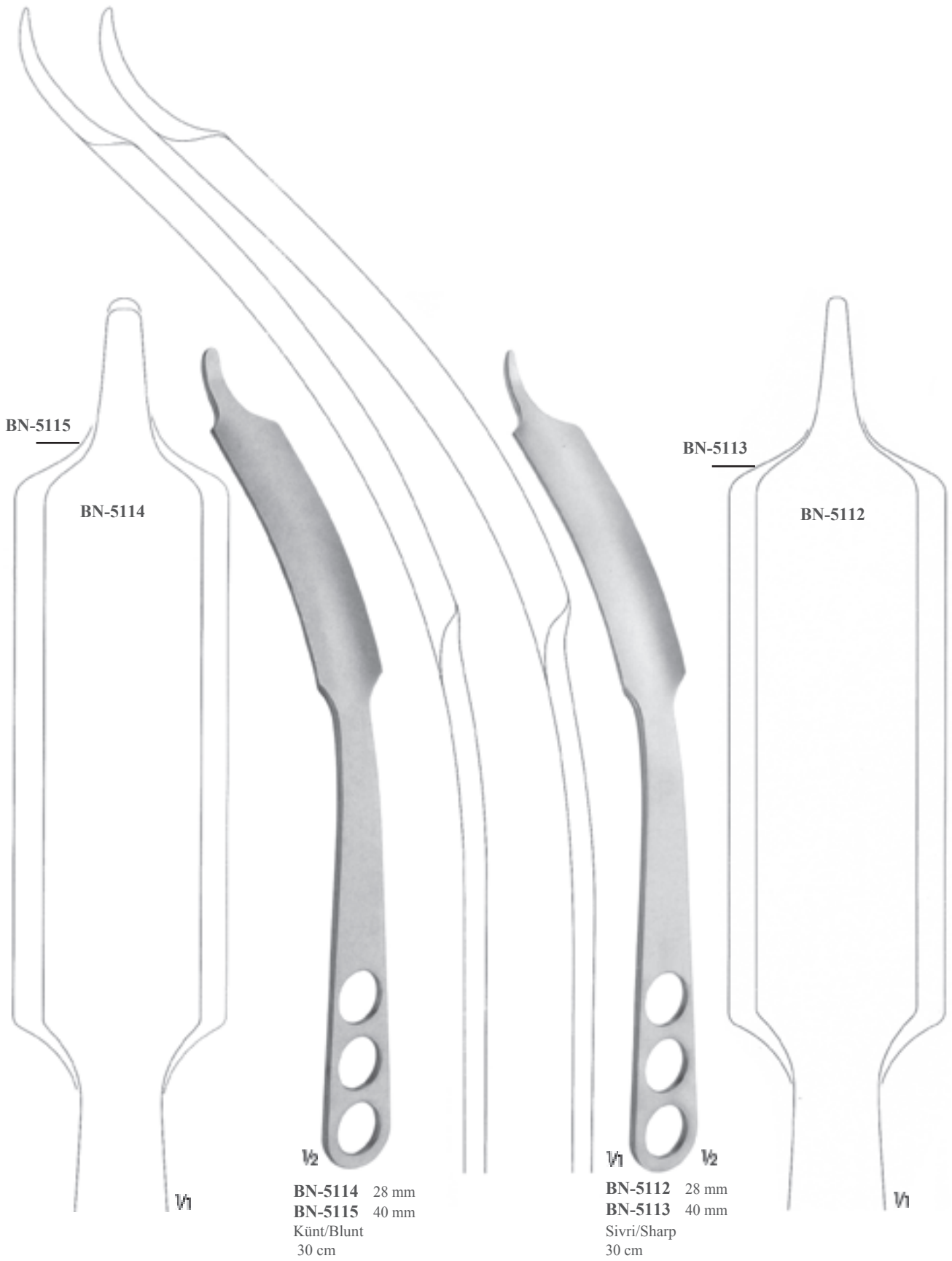

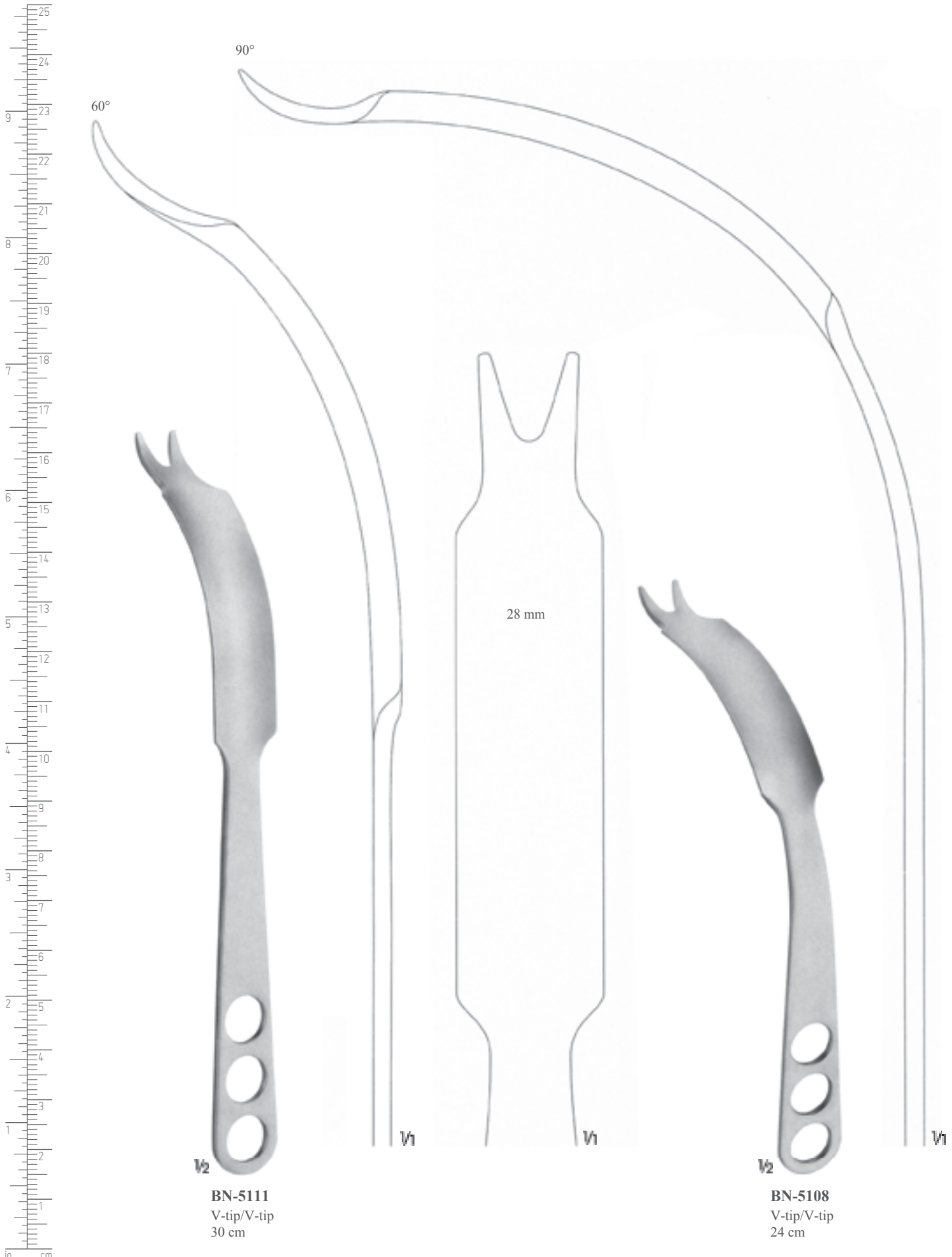

BN-5111
V-tip/V-tip
30 cm

BN-5108
V-tip/V-tip
24 cm

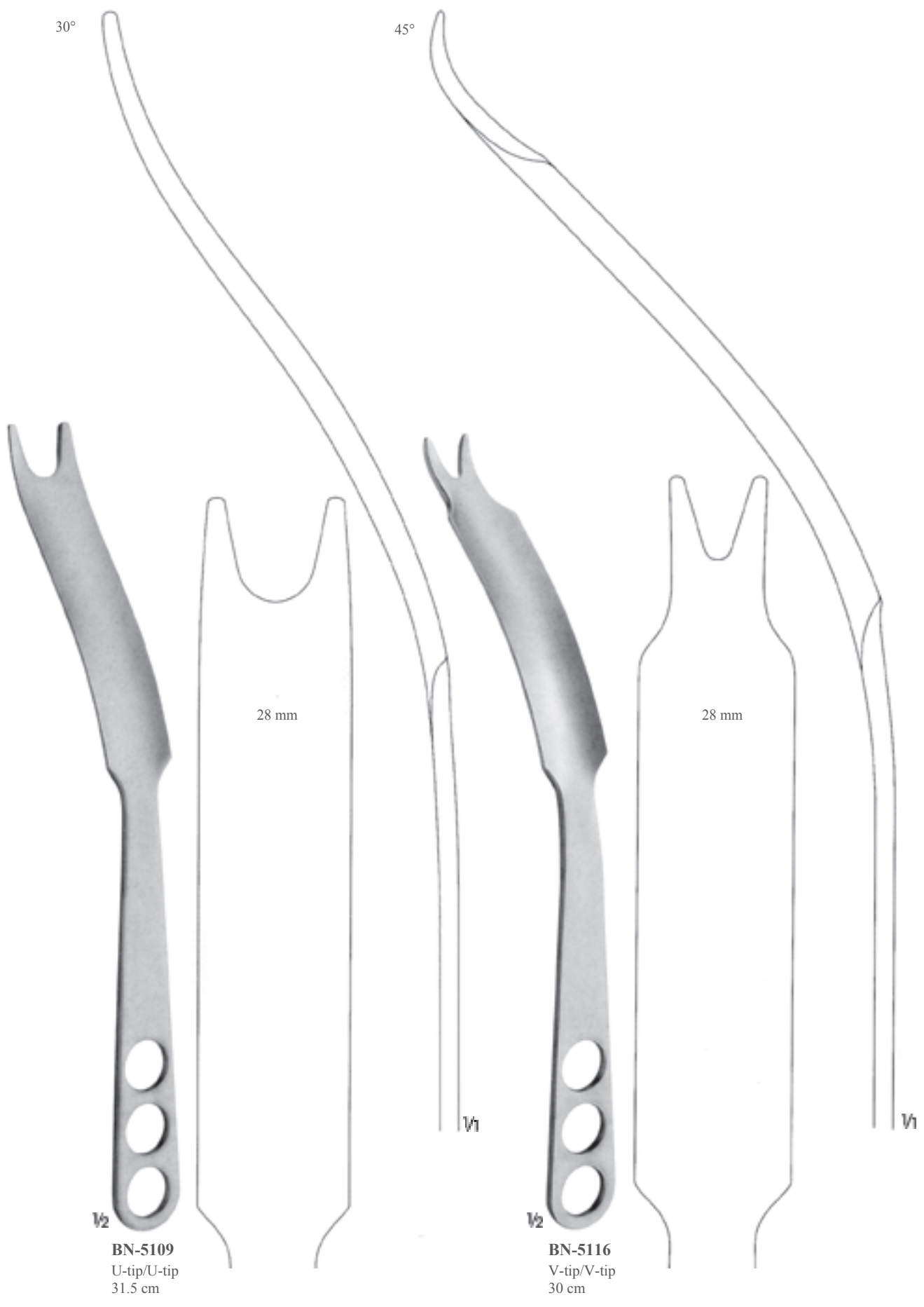

30°

45°

28 mm

28 mm

V₂

BN-5109
U-tip/U-tip
31.5 cm

V₁

V₂

BN-5116
V-tip/V-tip
30 cm



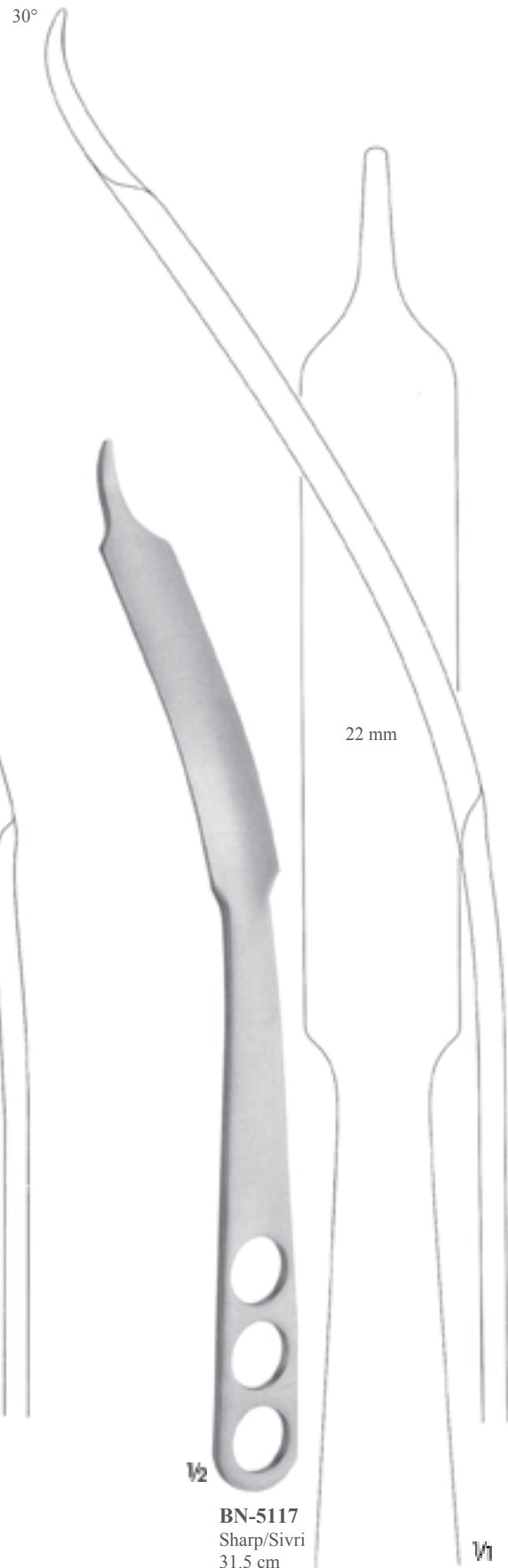
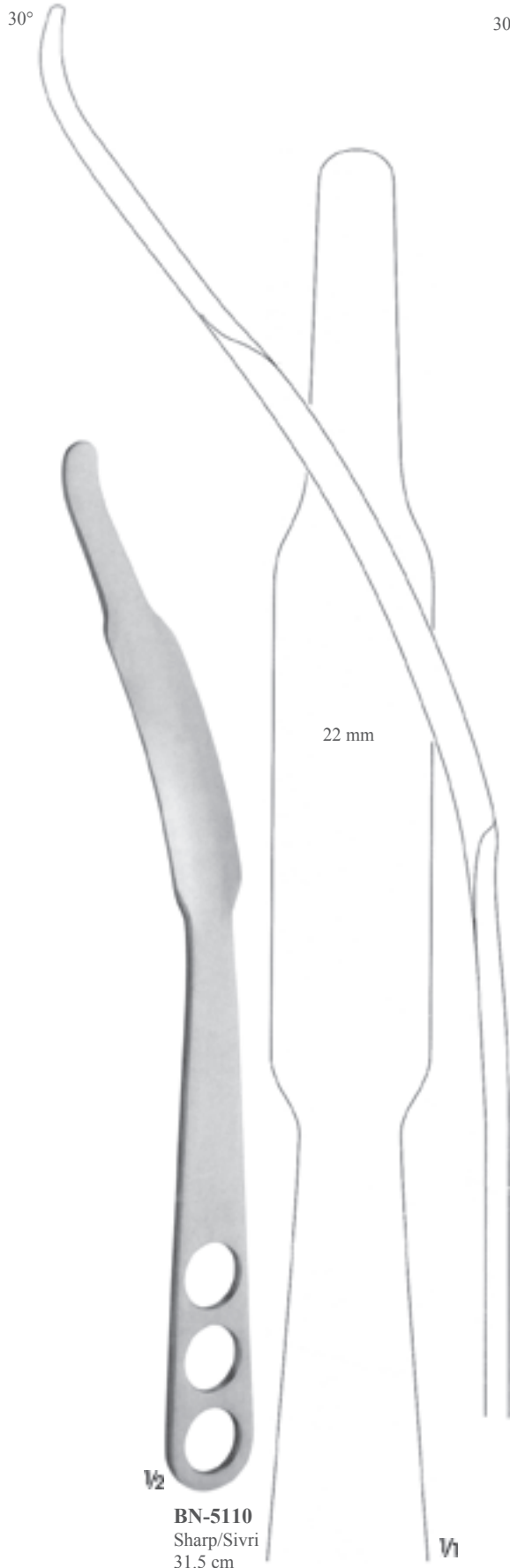

30°

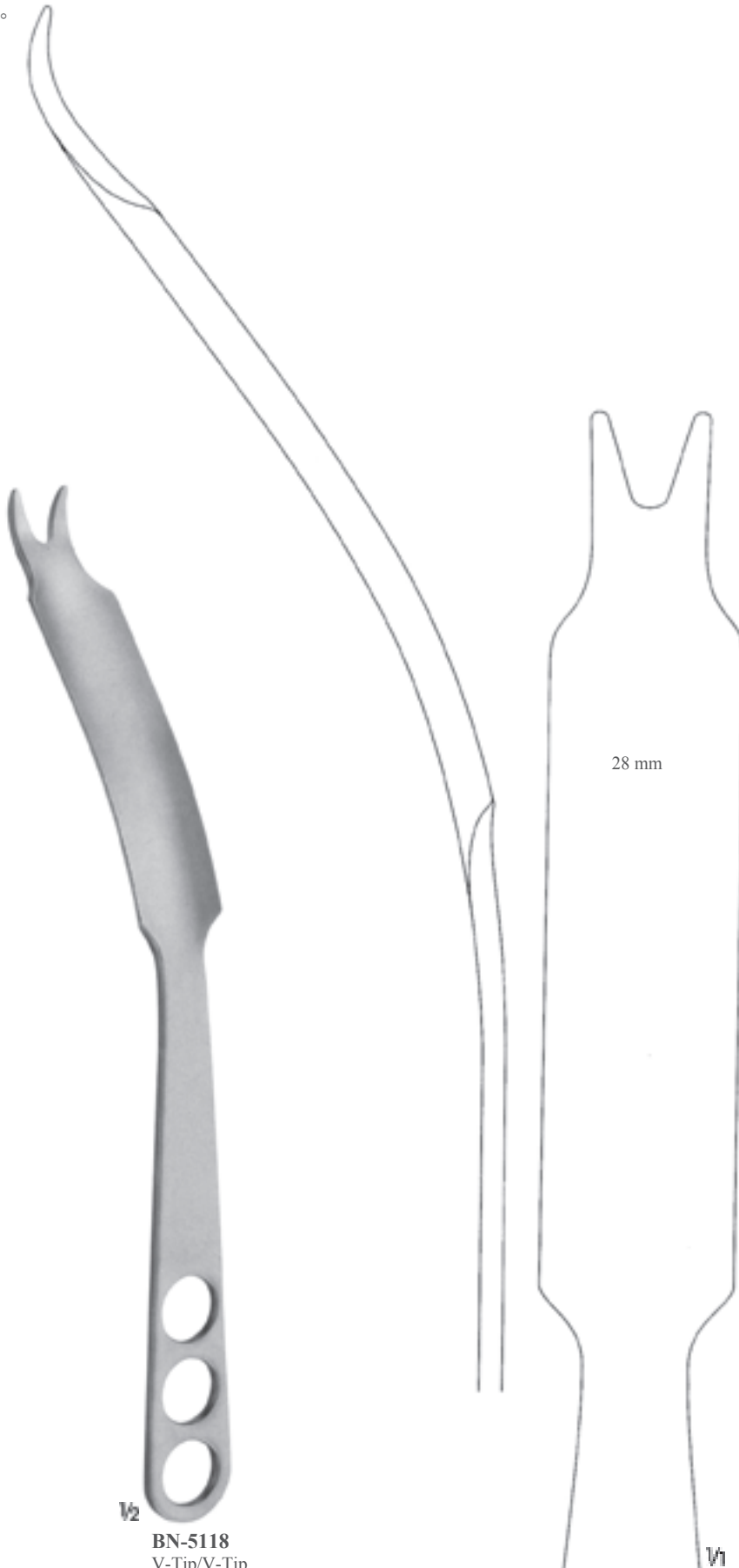

BN-5118
V-Tip/V-Tip
31.5 cm

28 mm

BN-5119
Kavrama silikonu
Hand grip

BN-5120
Kavrama silikonu
Hand grip

BN-5121
Kavrama silikonu
Hand grip

BN-5122
Kavrama silikonu
Hand grip



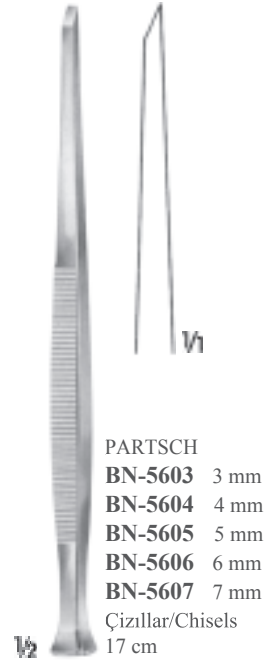
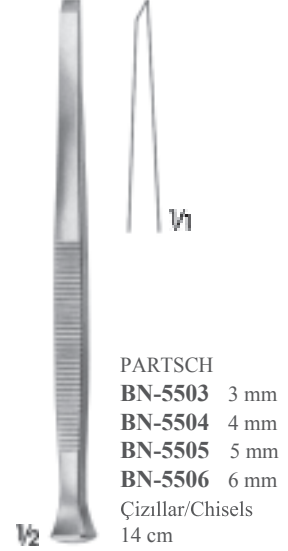
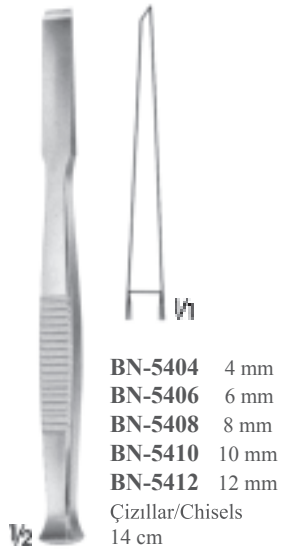
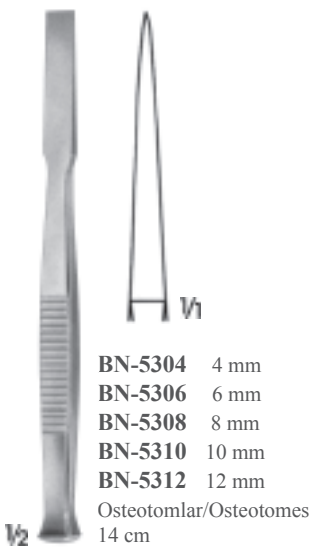
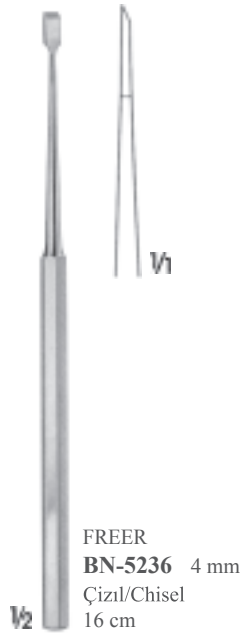
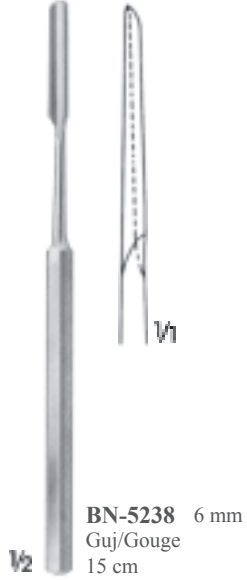
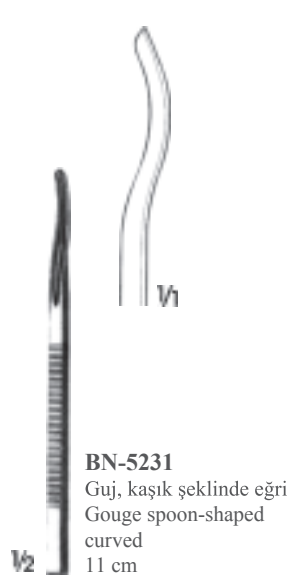
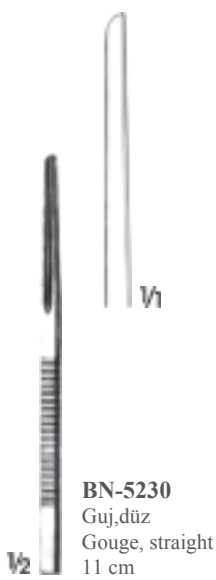

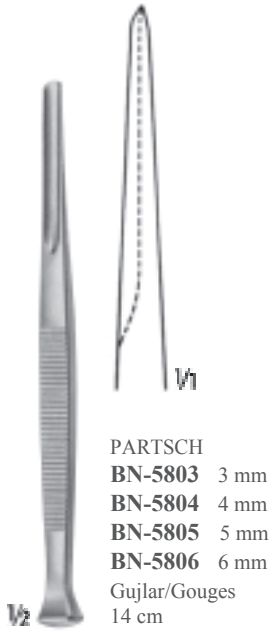

PARTSCH
BN-5803 3 mm
BN-5804 4 mm
BN-5805 5 mm
BN-5806 6 mm
 Gujlar/Gouges
 14 cm

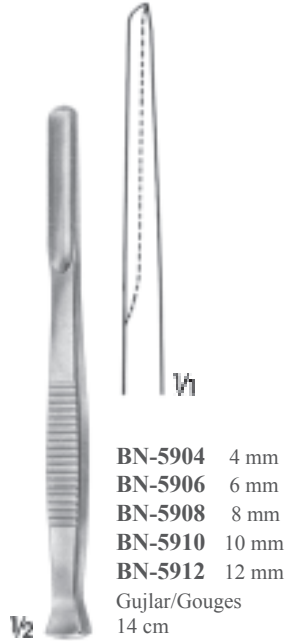

PARTSCH
BN-5904 4 mm
BN-5906 6 mm
BN-5908 8 mm
BN-5910 10 mm
BN-5912 12 mm
 Gujlar/Gouges
 14 cm



PARTSCH
BN-6003 3 mm
BN-6004 4 mm
BN-6005 5 mm
BN-6006 6 mm
BN-6007 7 mm
 Gujlar/Gouges
 17 cm



ALEXANDER
BN-6105 5 mm
BN-6107 7 mm
BN-6109 9 mm
BN-6111 11 mm
 Gujlar/Gouges
 17 cm

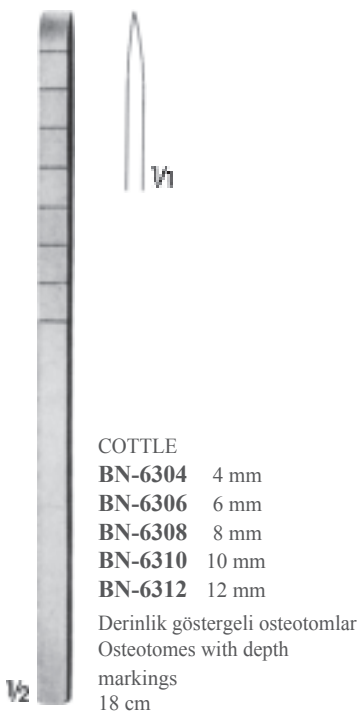

COTTLE
BN-6304 4 mm
BN-6306 6 mm
BN-6308 8 mm
BN-6310 10 mm
BN-6312 12 mm
 Derinlik göstergeli osteotomlar
 Osteotomes with depth
 markings
 18 cm

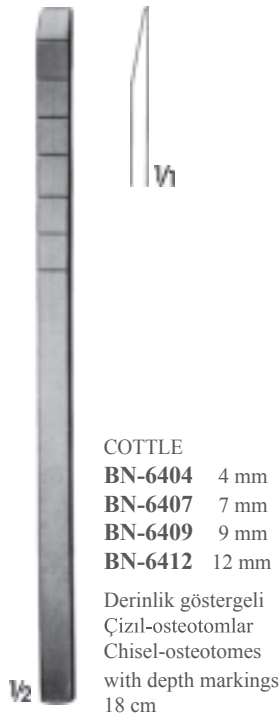

COTTLE
BN-6404 4 mm
BN-6407 7 mm
BN-6409 9 mm
BN-6412 12 mm
 Derinlik göstergeli
 Çizıl-osteotomlar
 Chisel-osteotomes
 with depth markings
 18 cm



COTTLE
BN-6415 6 mm
 Çizıl-osteotom
 Chisel-osteotomes
 18 cm



COTTLE
BN-6420 8 mm
 Derinlik göstergeli çizıl
 Chisel with depth
 markings
 18 cm



MANNERFELT
BN-6504 4 mm
BN-6506 6 mm
BN-6508 8 mm
Ostetomlar/Osteotomes
15.5 cm



MANNERFELT
BN-6550 3 mm
Guj/Gouges
15.5 cm



LUCAS
BN-6553 3 mm
BN-6555 5 mm
Gujlar/Gouges
16 cm



LUCAS
BN-6564 4 mm
BN-6566 6 mm
Çizıllar/Chisels
16 cm



KRAMER
BN-5240 2.6 mm
Elçekli çizıl
Shanks chisel
21.5 cm



EAST GRINSTEAD(WARD)
BN-8350 3 mm
BN-8355 5 mm
Çizıllar/Chisels
18 cm



EASTMAN
BN-8363 3 mm
BN-8365 5 mm
Çizıllar/Chisels
19 cm



EAST GRINSTEAD
BN-8373 3 mm
BN-8375 5 mm
Osteotomlar/Osteotomes
18 cm

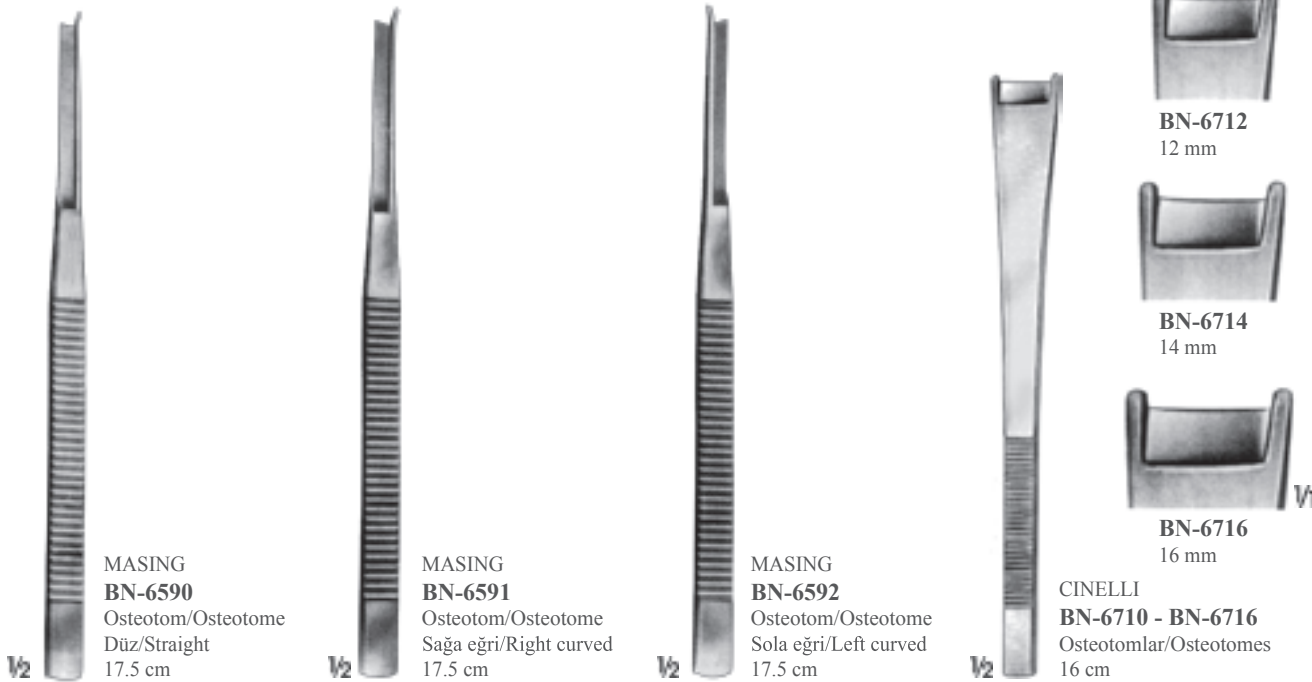
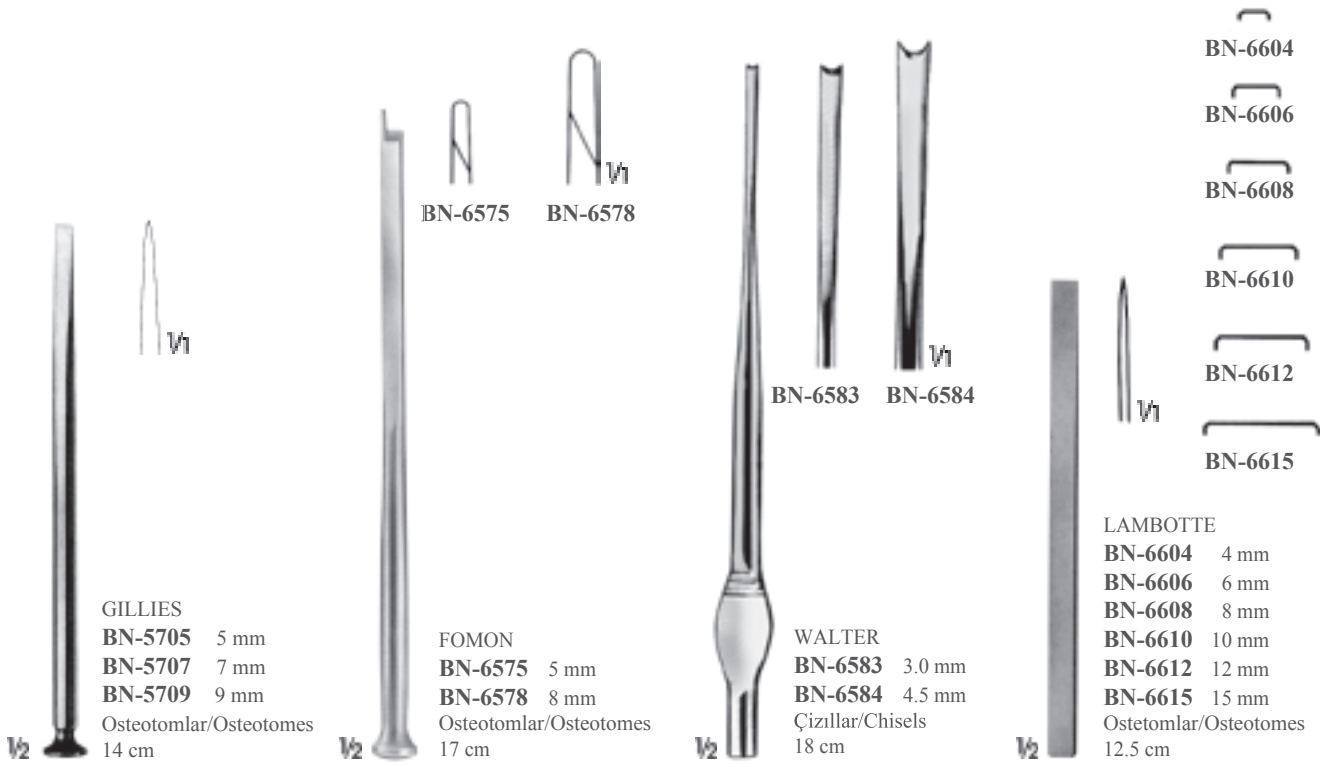



STILLE
BN-6810 10 mm
BN-6812 12 mm
BN-6815 15 mm
BN-6820 20 mm
BN-6825 25 mm
 Osteotomlar/Osteotomes
 20.5 cm

V₂



STILLE
BN-6908 8 mm
BN-6910 10 mm
BN-6912 12 mm
BN-6915 15 mm
BN-6920 20 mm
BN-6925 25 mm
 Osteotomlar/Osteotomes
 20.5 cm

V₂



STILLE
BN-7010 10 mm
BN-7012 12 mm
BN-7015 15 mm
BN-7020 20 mm
BN-7025 25 mm
 Çizallar/Chisels
 20.5 cm

V₂



STILLE
BN-7110 10 mm
BN-7112 12 mm
BN-7115 15 mm
BN-7120 20 mm
BN-7125 25 mm
 Osteotomlar/Osteotomes
 Eğri/Curved
 20.5 cm

V₂



STILLE
BN-7210 10 mm
BN-7212 12 mm
BN-7215 15 mm
BN-7220 20 mm
BN-7225 25 mm
 Gujlar/Gouges
 20.5 cm

V₂



WALTER
BN-7250 10 mm
BN-7255 15 mm
 Gref alıcı gujlar
 Gouges grafts recipient
 20.5 cm

V₂

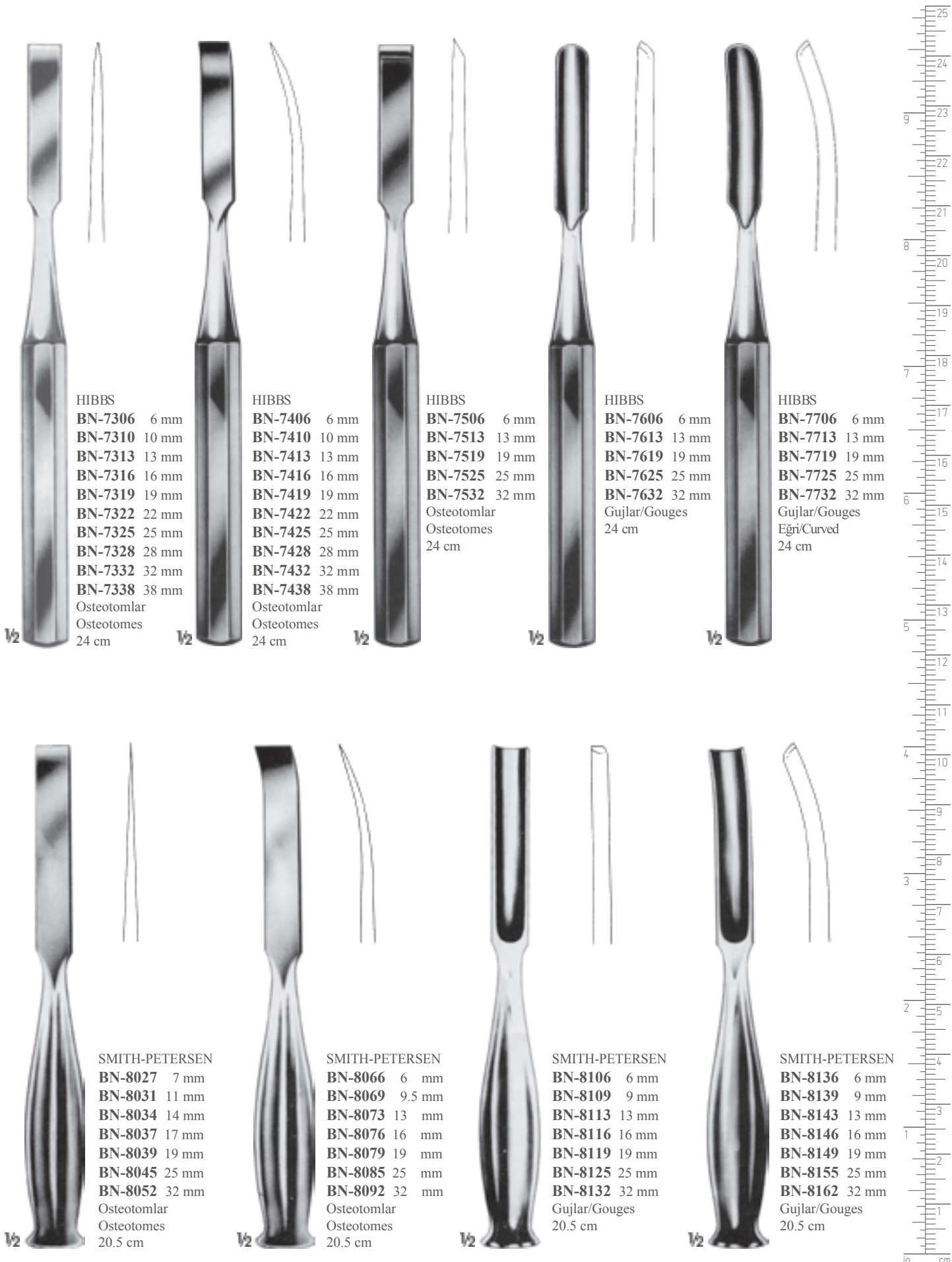

HIBBS

- BN-7306** 6 mm
- BN-7310** 10 mm
- BN-7313** 13 mm
- BN-7316** 16 mm
- BN-7319** 19 mm
- BN-7322** 22 mm
- BN-7325** 25 mm
- BN-7328** 28 mm
- BN-7332** 32 mm
- BN-7338** 38 mm
- Osteotomlar
- Osteotomes
- 24 cm

HIBBS

- BN-7406** 6 mm
- BN-7410** 10 mm
- BN-7413** 13 mm
- BN-7416** 16 mm
- BN-7419** 19 mm
- BN-7422** 22 mm
- BN-7425** 25 mm
- BN-7428** 28 mm
- BN-7432** 32 mm
- BN-7438** 38 mm
- Osteotomlar
- Osteotomes
- 24 cm

HIBBS

- BN-7506** 6 mm
- BN-7513** 13 mm
- BN-7519** 19 mm
- BN-7525** 25 mm
- BN-7532** 32 mm
- Osteotomlar
- Osteotomes
- 24 cm

HIBBS

- BN-7606** 6 mm
- BN-7613** 13 mm
- BN-7619** 19 mm
- BN-7625** 25 mm
- BN-7632** 32 mm
- Gujlar/Gouges
- 24 cm

HIBBS

- BN-7706** 6 mm
- BN-7713** 13 mm
- BN-7719** 19 mm
- BN-7725** 25 mm
- BN-7732** 32 mm
- Gujlar/Gouges
- Eğri/Curved
- 24 cm

SMITH-PETERSEN

- BN-8027** 7 mm
- BN-8031** 11 mm
- BN-8034** 14 mm
- BN-8037** 17 mm
- BN-8039** 19 mm
- BN-8045** 25 mm
- BN-8052** 32 mm
- Osteotomlar
- Osteotomes
- 20.5 cm

SMITH-PETERSEN

- BN-8066** 6 mm
- BN-8069** 9.5 mm
- BN-8073** 13 mm
- BN-8076** 16 mm
- BN-8079** 19 mm
- BN-8085** 25 mm
- BN-8092** 32 mm
- Osteotomlar
- Osteotomes
- 20.5 cm

SMITH-PETERSEN

- BN-8106** 6 mm
- BN-8109** 9 mm
- BN-8113** 13 mm
- BN-8116** 16 mm
- BN-8119** 19 mm
- BN-8125** 25 mm
- BN-8132** 32 mm
- Gujlar/Gouges
- 20.5 cm

SMITH-PETERSEN

- BN-8136** 6 mm
- BN-8139** 9 mm
- BN-8143** 13 mm
- BN-8146** 16 mm
- BN-8149** 19 mm
- BN-8155** 25 mm
- BN-8162** 32 mm
- Gujlar/Gouges
- 20.5 cm

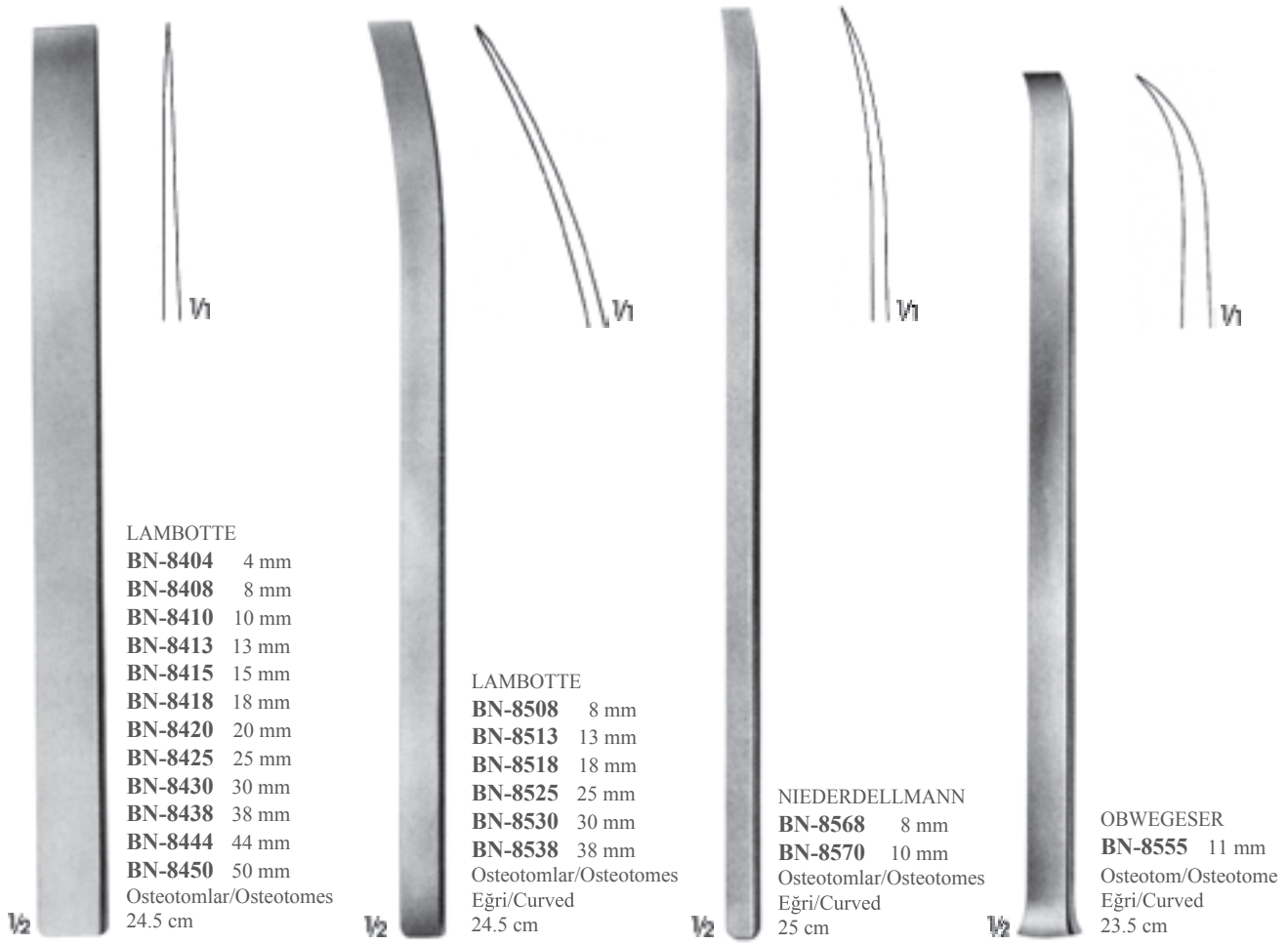

LAMBOTTE

- BN-8404** 4 mm
 - BN-8408** 8 mm
 - BN-8410** 10 mm
 - BN-8413** 13 mm
 - BN-8415** 15 mm
 - BN-8418** 18 mm
 - BN-8420** 20 mm
 - BN-8425** 25 mm
 - BN-8430** 30 mm
 - BN-8438** 38 mm
 - BN-8444** 44 mm
 - BN-8450** 50 mm
- Osteotomlar/Osteotomes
24.5 cm

LAMBOTTE

- BN-8508** 8 mm
 - BN-8513** 13 mm
 - BN-8518** 18 mm
 - BN-8525** 25 mm
 - BN-8530** 30 mm
 - BN-8538** 38 mm
- Osteotomlar/Osteotomes
Eğri/Curved
24.5 cm

NIEDERDELLMANN

- BN-8568** 8 mm
 - BN-8570** 10 mm
- Osteotomlar/Osteotomes
Eğri/Curved
25 cm

OBWEGESER

- BN-8555** 11 mm
- Osteotom/Osteotome
Eğri/Curved
23.5 cm

143° buhar sterilizatörlerinde steril edilebilir.
Can be sterilized in a steam sterilizer up to 143°



BY - 1540
Anahtar/Key

25 mm



BN-8650



BN-8660



BN-8670



BN-8580
Değiştirilebilir bıçaklı,
çizil
(BY-1540 ile)
Changeable blades,
chisel
(BY-1540 with key)



BN-8605 5 mm
BN-8610 10 mm
BN-8616 16 mm
BN-8625 25 mm
Boy/Length 45 mm



BN-8626 25 mm
Boy/Length 78 mm



BN-8650 50 mm
BN-8660 60 mm
BN-8670 70 mm

143° buhar sterilizatörlerinde steril edilebilir.
Can be sterilized in a steam sterilizer up to 143°



BN-8801 10 mm
BN-8811 15 mm
BN-8821 20 mm
Çizıl/Chisels
20 cm



BN-8831 10 mm
BN-8841 15 mm
BN-8851 20 mm
Çizıl, eğri/Chisels, curved
20 cm



LEXER-MINI
BN-8861 4 mm
BN-8871 6 mm
BN-8881 8 mm
BN-8891 10 mm
BN-8896 12 mm
Osteotomlar/Osteotomes
18 cm



LEXER-MINI
BN-8901 4 mm
BN-8911 6 mm
BN-8921 8 mm
BN-8931 10 mm
BN-8941 12 mm
Gujlar/Gouges
18 cm



LEXER
BN-9005 5 mm
BN-9007 7 mm
BN-9010 10 mm
BN-9015 15 mm
BN-9020 20 mm
BN-9025 25 mm
BN-9030 30 mm
Osteotomlar/Osteotomes
22 cm



LEXER
BN-9105 5 mm
BN-9107 7 mm
BN-9110 10 mm
BN-9115 15 mm
BN-9120 20 mm
BN-9125 25 mm
BN-9130 30 mm
Gujlar/Gouges
22 cm





143° buhar sterilizatörlerinde steril edilebilir.
Can be sterilized in a steam sterilizer up to 143°



V2

BN-9201 9 mm
Kırık vida çıkartıcı guj
Broken screw extractor
gouges
22 cm



V1



V2

ZIELKE
BN-9202 5.5 mm
BN-9203 9.0 mm
Skolyoz operasyonu için gujlar
Gouges for scoliosis operations
23 cm



V1



V2

BN-9245 5 mm
BN-9250 10 mm
Sponjiyoz gujlar, eğri
Spongiosa gouges, curved
25 cm



V1



V2

LEXER
BN-9469
Sponjiyoz guj
Spongiosa gouges
28 cm

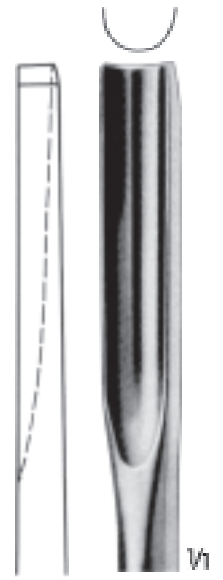

V1



143 ° buhar sterilizatörlerinde steril edilebilir.
Can be sterilized in a steam sterilizer up to 143 °



BN-9440 20 mm
Çizıl/Chisels
24.5 cm



BN-9441 16 mm
Çizıl, eğri
Chisel, curved
26.5 cm



LEXER
BN-9450 10 mm
BN-9451 15 mm
Osteotomlar, açılı
Osteotomes angled
27.5 cm





143° buhar sterilizatörlerinde steril edilebilir.
Can be sterilized in a steam sterilizer up to 143°



143 ° buhar sterilizatörlerinde steril edilebilir.
Can be sterilized in a steam sterilizer up to 143 °

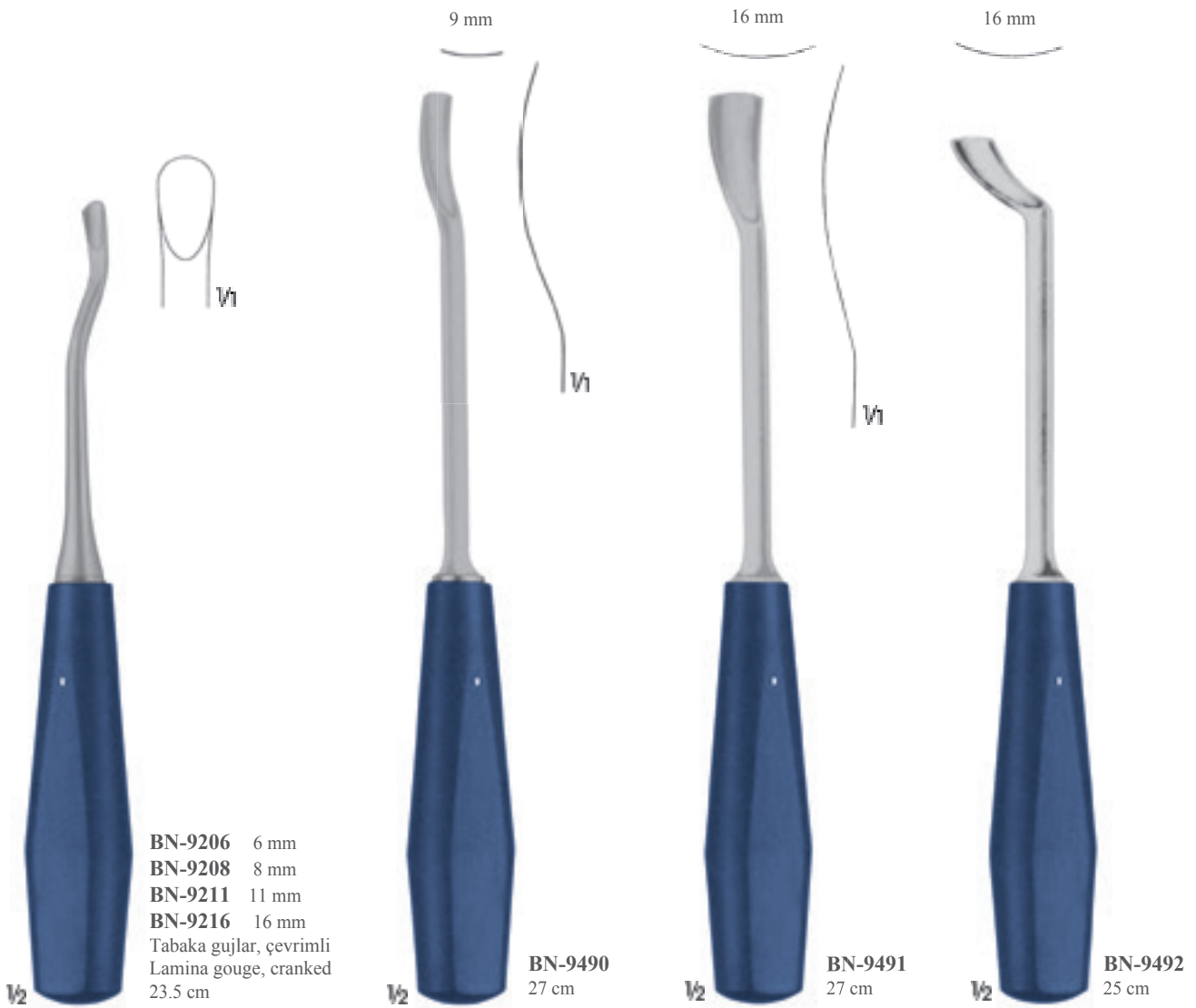



8 mm



1/2

COBB
BN-9500
28 cm

8 mm



1/2

COBB
BN-9501
28 cm

8 mm



1/2

COBB
BN-9502
28 cm

8 mm



1/2

COBB
BN-9503
28 cm

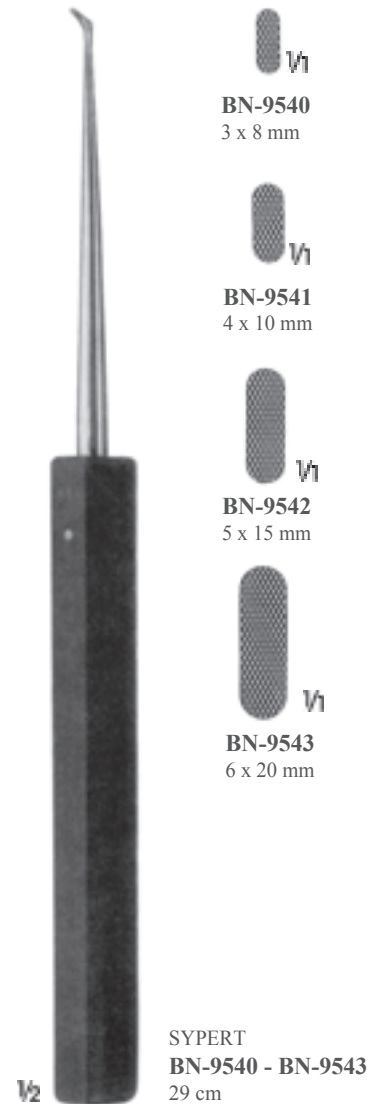
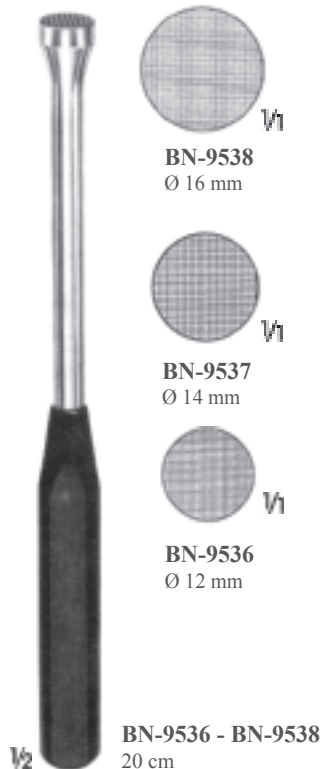
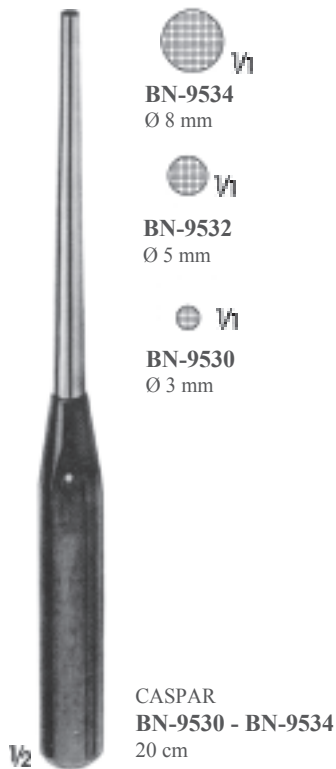
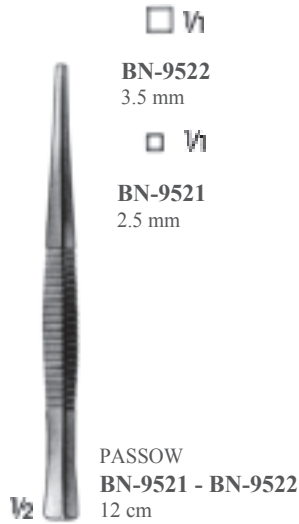



Çekiçin başlıklarına göre ağırlıkları değişebilir
Weights refer to heads of the mallets



Ø 22 mm

BN-9770

80 gr
16.5 cm

1/2



Ø 25 mm

BN-9955 130 gr.

Bir yüzeyi pürüzlü,
Bir yüzeyi pürüzsüz
With one smooth and one
rough surface
18.5 cm

1/2



Ø 23 mm

FICKLING

BN-9950 190 gr.
19 cm

1/2



CLOWARD

BN-9800 230 gr.
19 cm

BN-9801 370 gr.
23 cm

1/2



Ø 22 mm

BN-9775

155 gr
19 cm

1/2



Ø 27 mm

HAJEK

BN-9780
135 gr.
22 cm

1/2



Çekiğin başlıklarına göre ağırlıkları değişebilir
Weights refer to heads of the mallets



Ø 20 mm

MEAD
BN-9600 180 gr
Plastik diskli/Plastic disc
19 cm

BN-9601
Yedek disk bir çift
Pair of spare disc

1/2



Ø 25 mm

BN-9602 135 gr
Plastik diskli/Plastic disc
18.5 cm

BN-9603
Yedek disk bir çift
Pair of spare disc

1/2



Ø 30 mm

BN-9605
Yedek disk bir çift
Pair of Spare disc

BN-9604 200 gr
Plastik diskli/Plastic disc
24.5 cm

1/2



Ø 35 mm

Diskler olmadan çekiç kafa 125 gr
Mallet head without discs 125 gr

WAGNER
BN-9635 Komple/Complete
Bir metal disk/Metal disc BN-9650
Bir plastik disk/Plastic disc BN-9651
Bir anahtar/Wrench BN-9655
23.5 cm

1/2



BN-9650 215 gr.
1 Metal disk, düz
1 Metal disc, flat
1 Metal disk, konveks
1 Metal disc, convex



BN-9651 30 gr.
1 Plastik disk, düz
1 Plastic disc, flat
1 Plastik disk, konveks
1 Plastic disc, convex



BN-9655
Anahtar/Wrench





Çekicinin başlıklarına göre ağırlıkları değişebilir
Weights refer to heads of the mallets



Ø 30 mm

COTTLE
BN-9810 235 gr
Bir tarafı düz, bir tarafı bombeli
a side flat, a side convex
18.5cm

1/2



HEATH
BN-9820 660 gr
Ø 40 mm 18.5 cm
BN-9830 725 gr
Ø 45 mm 20 cm
Ağır çekiç
Triphammer



Ø 30 mm

BERGMANN
BN-9850 245 gr
23.5 cm

1/2



Ø 40 mm

OMBREDANNE
BN-9900 520 gr
24 cm

1/2





Ø 45 mm

BERGMANN
BN-9855 300 gr
24.5 cm

1/2

Çekicinin başlıklarına göre ağırlıkları değişebilir
Weights refer to heads of the mallets



Ø 30 mm

Ø 42 mm

BN-9920 285 gr
24 cm

1/2



143 ° buhar sterilizatörlerinde steril edilebilir.
Can be sterilized in a steam sterilizer up to 143 °

BN-9735 Ø 35 mm
BN-9742 Ø 42 mm
BN-9750 Ø 50 mm
25 cm

1/2



□ 27 mm

Ø 13.5 mm

BN-9910 425 gr
Implantlara uygun
ortopedik çekiç
Head made of material
used for implants
23.5 cm

1/2



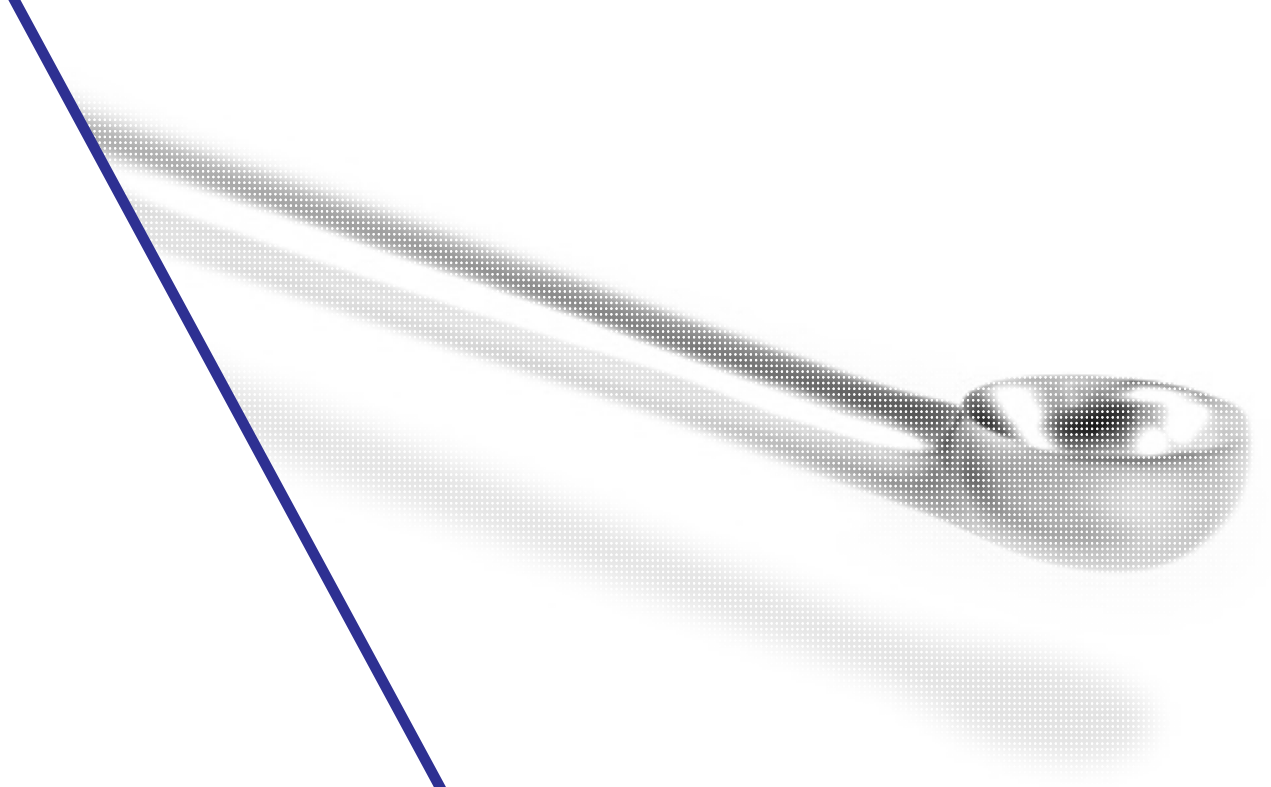

BP

Kemik Kretleri
Bone Curettes

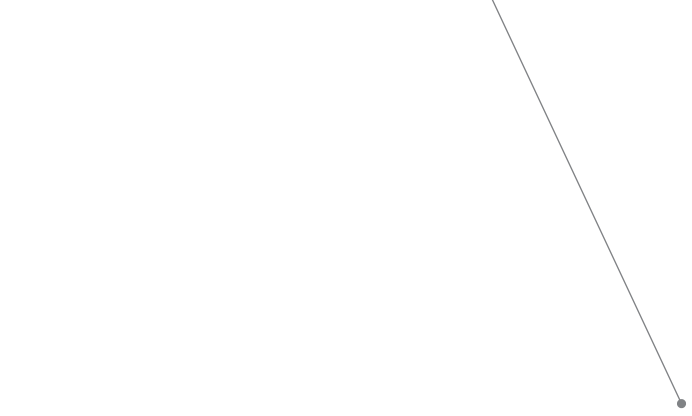

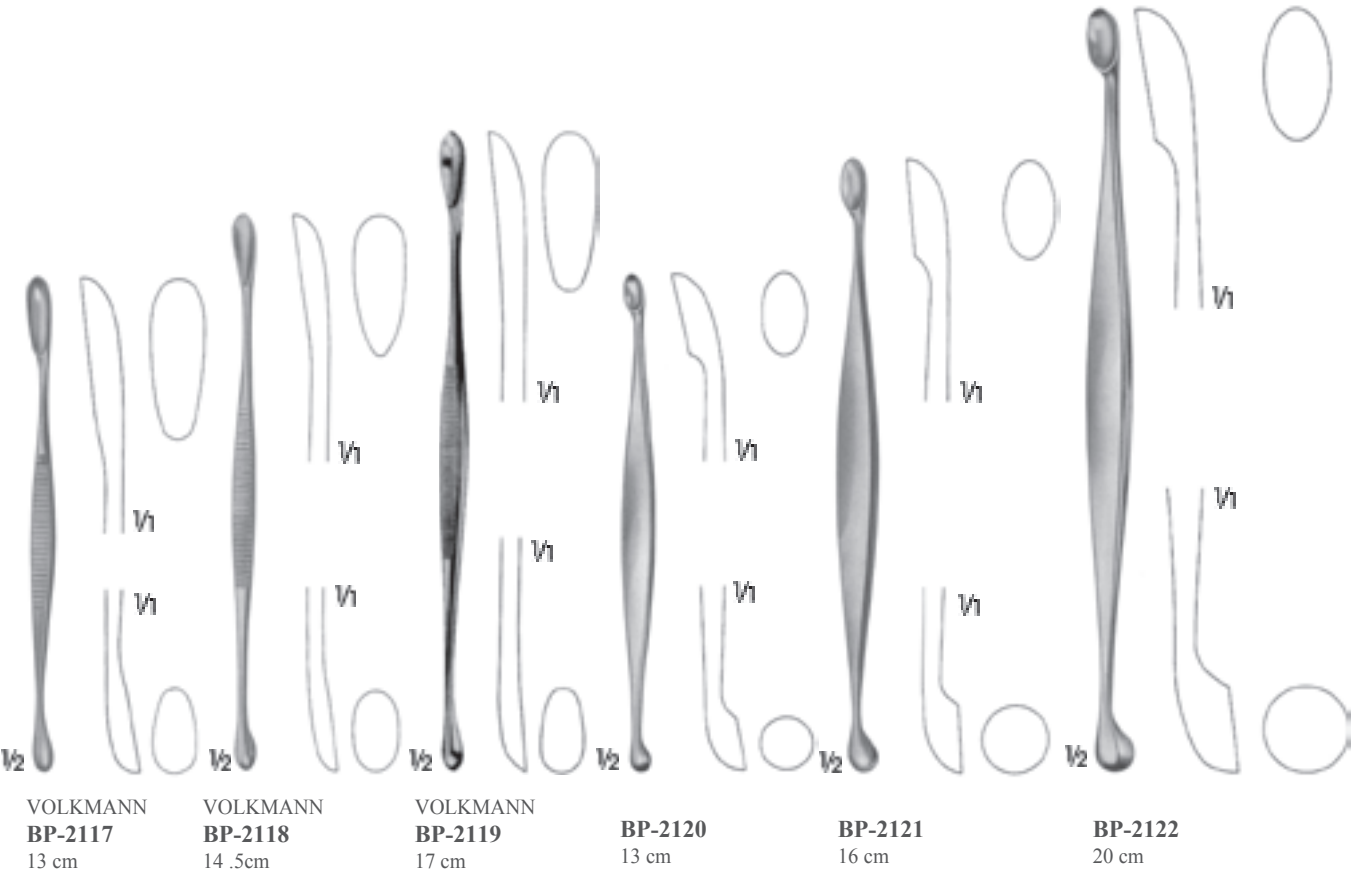
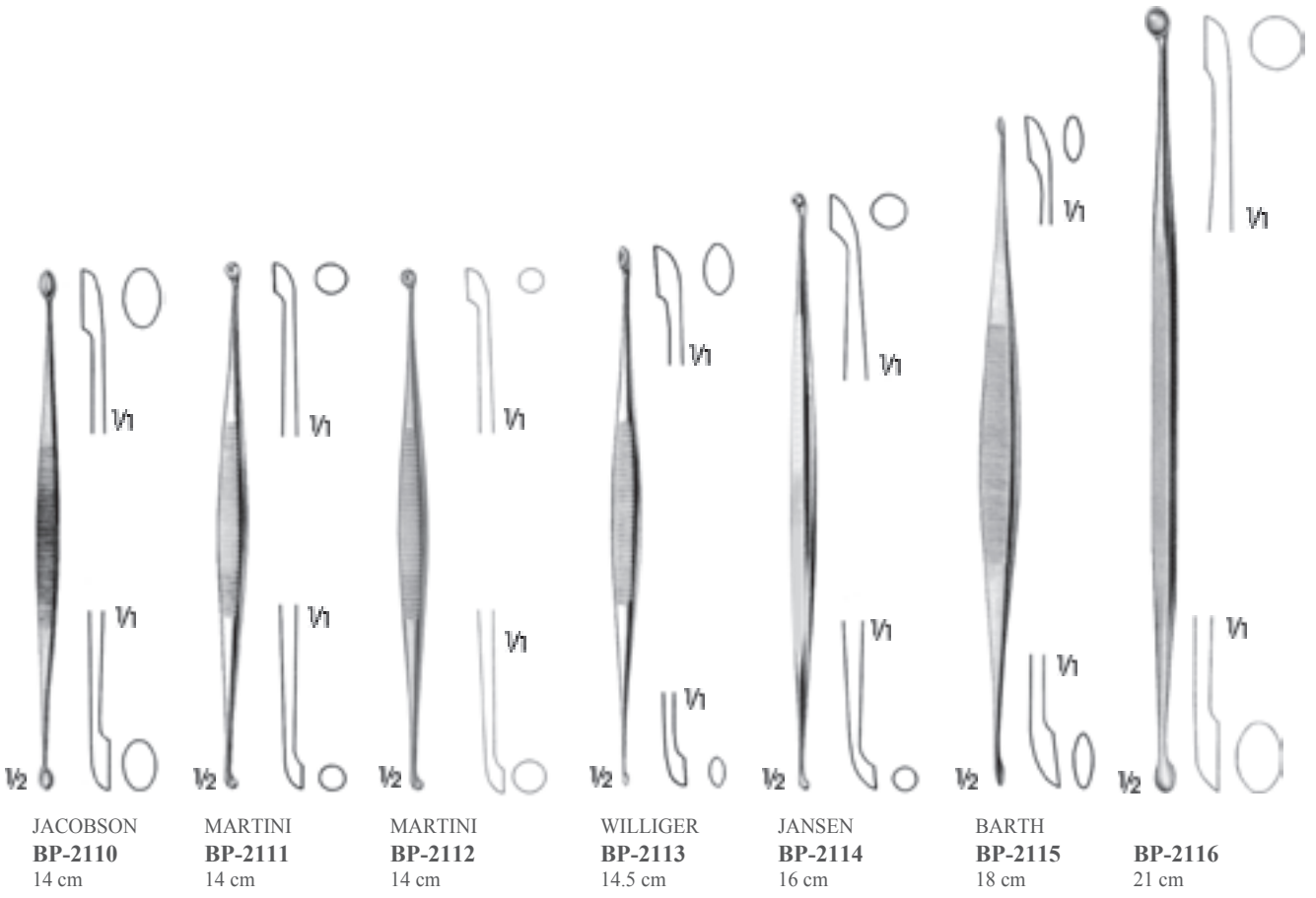

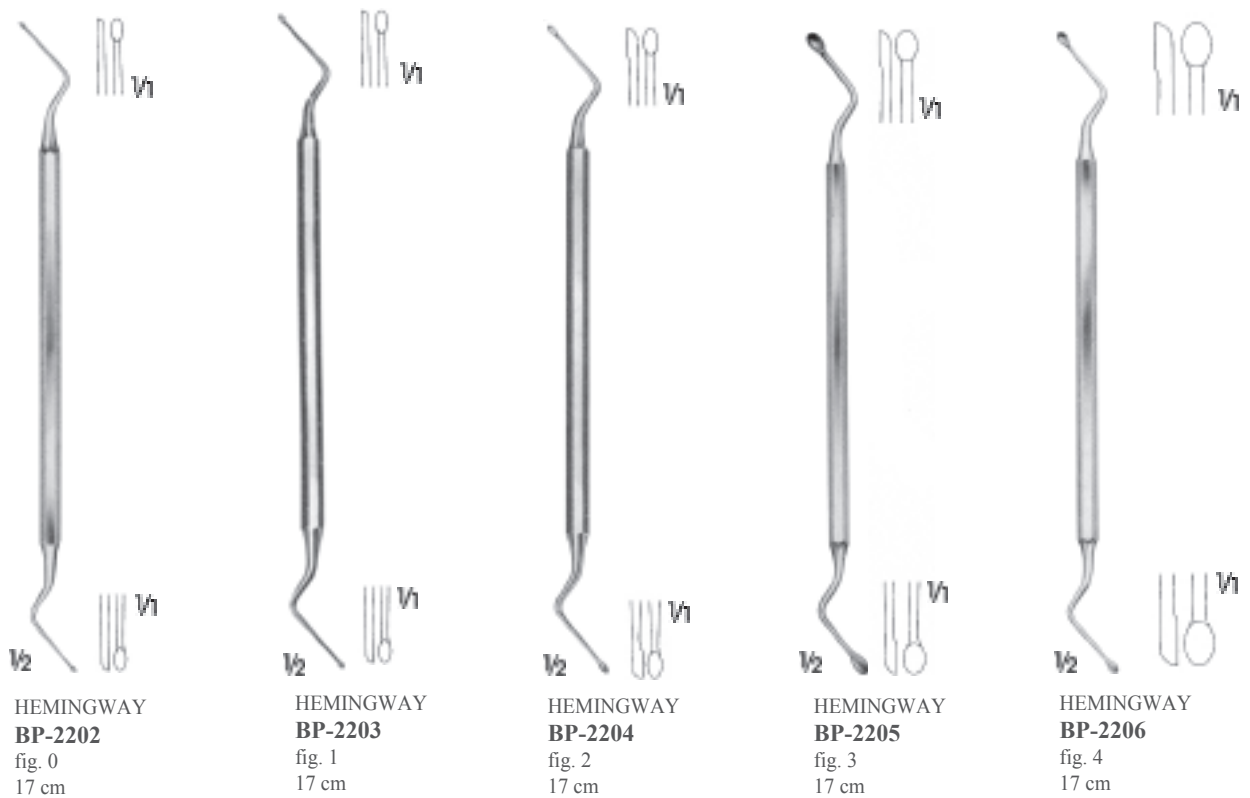
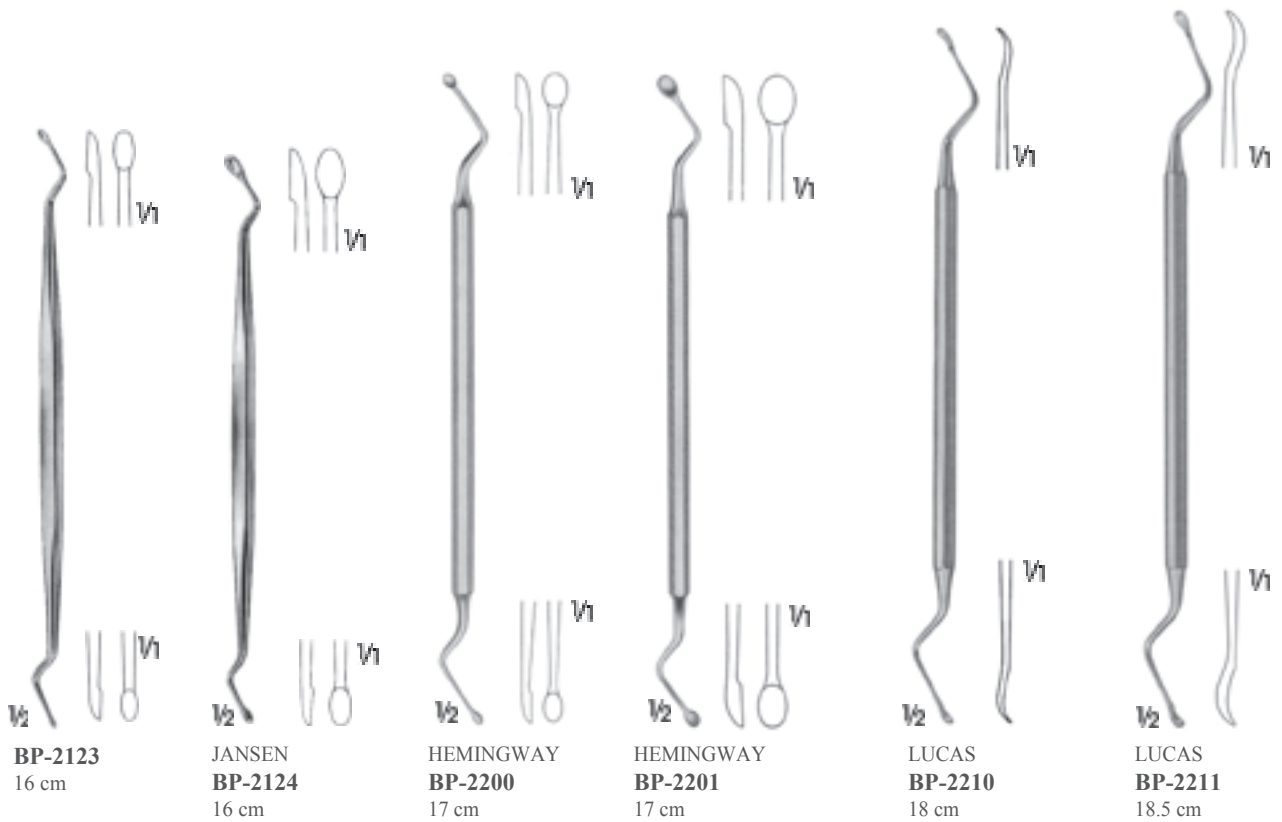



SCHEDÉ
BP-2280 - BP-2286
17 cm

fig. 000	fig. 00	fig. 0	fig. 1
BP-2280 3 mm	BP-2281 3.5 mm	BP-2282 4 mm	BP-2283 5.5 mm
fig. 2	fig. 3	fig. 4	
BP-2284 7 mm	BP-2285 8 mm	BP-2286 10.5 mm	

SCHEDÉ
BP-2287 - BP-2293
17 cm

fig. 000	fig. 00	fig. 0	fig. 1
BP-2287 2.5 mm	BP-2288 3.4 mm	BP-2289 4.2 mm	BP-2290 5.2 mm
fig. 2	fig. 3	fig. 4	
BP-2291 6.3 mm	BP-2292 7.4 mm	BP-2293 8 mm	

BRUNS
BP-2300 - BP-2306
16.5 cm

fig. 000	fig. 00	fig. 0	fig. 1
BP-2300 3 mm	BP-2301 4 mm	BP-2302 5 mm	BP-2303 6 mm
fig. 2	fig. 3	fig. 4	
BP-2304 8 mm	BP-2305 10 mm	BP-2306 12 mm	

BRUNS
BP-2307 - BP-2313
16.5 cm

fig. 000	fig. 00	fig. 0	fig. 1
BP-2307 3 mm	BP-2308 4 mm	BP-2309 5 mm	BP-2310 6 mm
fig. 2	fig. 3	fig. 4	
BP-2311 8 mm	BP-2312 10 mm	BP-2313 12 mm	

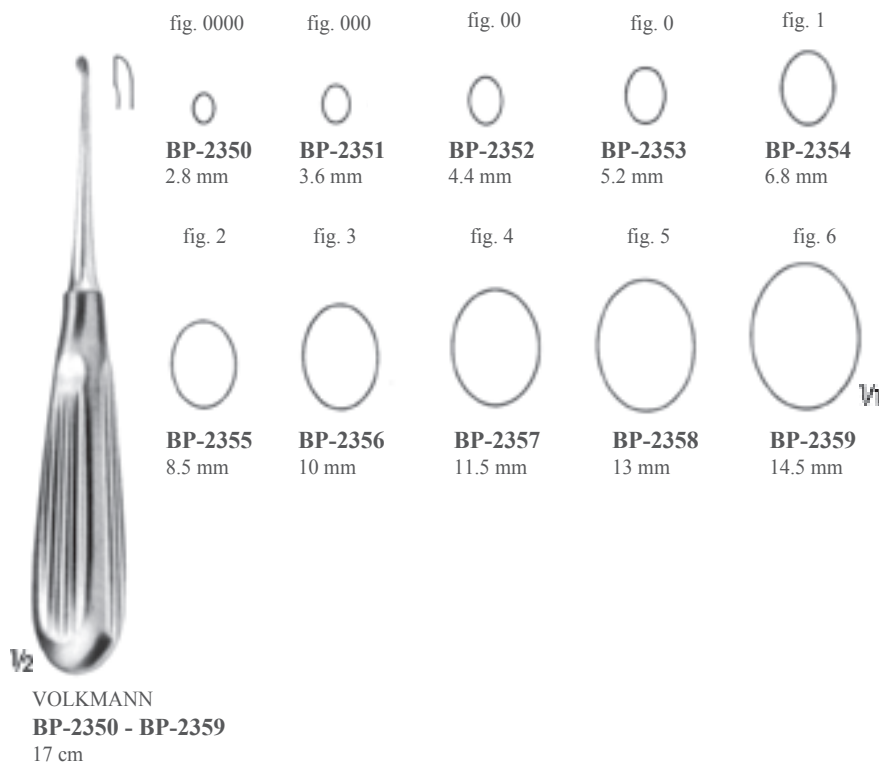

VOLKMANN
BP-2350 - BP-2359
17 cm

fig. 0000 BP-2350 2.8 mm	fig. 000 BP-2351 3.6 mm	fig. 00 BP-2352 4.4 mm	fig. 0 BP-2353 5.2 mm	fig. 1 BP-2354 6.8 mm
fig. 2 BP-2355 8.5 mm	fig. 3 BP-2356 10 mm	fig. 4 BP-2357 11.5 mm	fig. 5 BP-2358 13 mm	fig. 6 BP-2359 14.5 mm



WILLIGER
BP-2360 - BP-2361
17 cm

fig. 00 BP-2360 3.4 mm	fig. 1 BP-2361 5.2 mm
------------------------------	-----------------------------

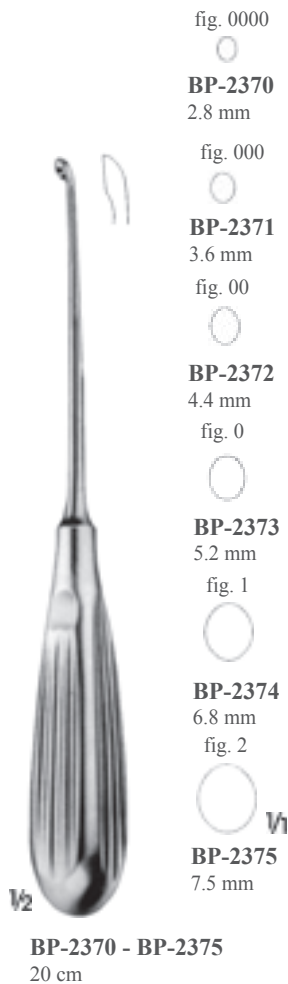

BP-2370 - BP-2375
20 cm

fig. 0000 BP-2370 2.8 mm	fig. 000 BP-2371 3.6 mm	fig. 00 BP-2372 4.4 mm	fig. 0 BP-2373 5.2 mm	fig. 1 BP-2374 6.8 mm	fig. 2 BP-2375 7.5 mm
--------------------------------	-------------------------------	------------------------------	-----------------------------	-----------------------------	-----------------------------

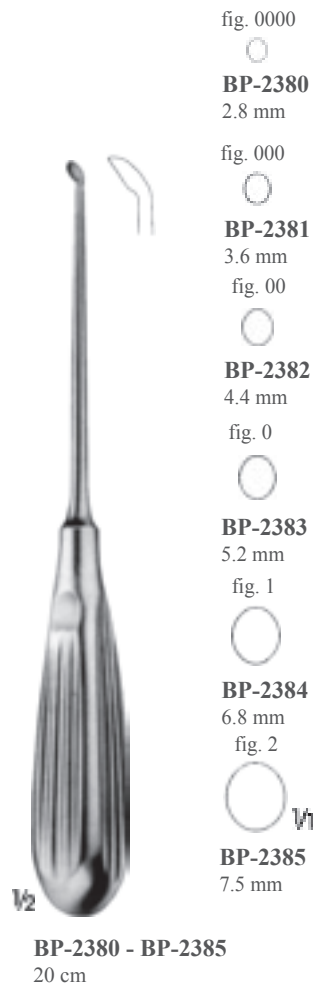

BP-2380 - BP-2385
20 cm

fig. 0000 BP-2380 2.8 mm	fig. 000 BP-2381 3.6 mm	fig. 00 BP-2382 4.4 mm	fig. 0 BP-2383 5.2 mm	fig. 1 BP-2384 6.8 mm	fig. 2 BP-2385 7.5 mm
--------------------------------	-------------------------------	------------------------------	-----------------------------	-----------------------------	-----------------------------

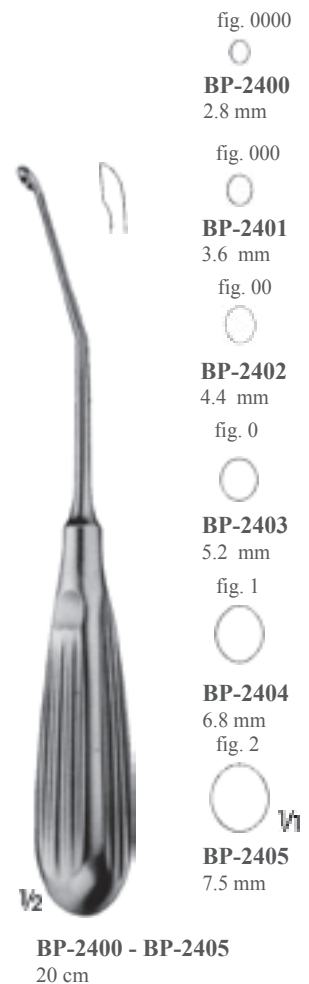

BP-2400 - BP-2405
20 cm

fig. 0000 BP-2400 2.8 mm	fig. 000 BP-2401 3.6 mm	fig. 00 BP-2402 4.4 mm	fig. 0 BP-2403 5.2 mm	fig. 1 BP-2404 6.8 mm	fig. 2 BP-2405 7.5 mm
--------------------------------	-------------------------------	------------------------------	-----------------------------	-----------------------------	-----------------------------





fig. 0000
BP-2410
2.8 mm

fig. 000
BP-2411
3.6 mm

fig. 00
BP-2412
4.4 mm

fig. 0
BP-2413
5.2 mm

DAUBENSPECK
BP-2410 - BP-2413
20 cm

fig. 0000
BP-2420
1.8 mm

fig. 000
BP-2421
2.0 mm

fig. 00
BP-2422
2.4 mm

fig. 0
BP-2423
2.6 mm

fig. 1
BP-2424
2.8 mm

LEMBERT
BP-2420 - BP-2424
20 cm

fig. 00
BP-2430
4.4 mm

fig. 0
BP-2431
5.2 mm

fig. 1
BP-2432
6.8 mm

HALLE
BP-2430 - BP-2432
21.5 cm

fig. 000
BP-2450
3.6 mm

fig. 00
BP-2451
4.4 mm

fig. 0
BP-2452
5.2 mm

fig. 1
BP-2453
6.8 mm

BP-2450 - BP-2453
25 cm

fig. 000
BP-2460
3.6 mm

fig. 00
BP-2461
4.4 mm

fig. 0
BP-2462
5.2 mm

fig. 1
BP-2463
6.8 mm

BP-2460 - BP-2463
25 cm

BP-2470
3 mm

BP-2471
4 mm

BP-2472
5 mm

BUSHE
BP-2470 - BP-2472
25 cm

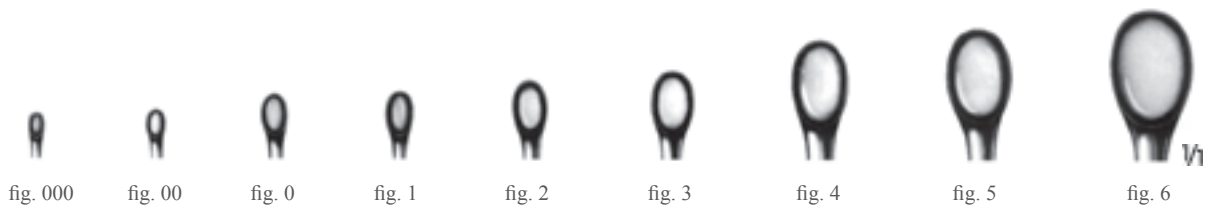

BP-2500 1.8 mm	BP-2501 2.2 mm	BP-2502 3.5 mm	BP-2503 4.0 mm	BP-2504 4.5 mm	BP-2505 5.5 mm	BP-2506 7.2 mm	BP-2507 8.5 mm	BP-2508 10.5 mm
BP-2510 1.8 mm	BP-2511 2.2 mm	BP-2512 3.5 mm	BP-2513 4.0 mm	BP-2514 4.5 mm	BP-2515 5.5 mm	BP-2516 7.2 mm	BP-2517 8.5 mm	BP-2518 10.5 mm
BP-2520 1.8 mm	BP-2521 2.2 mm	BP-2522 3.5 mm	BP-2523 4.0 mm	BP-2524 4.5 mm	BP-2525 5.5 mm	BP-2526 7.2 mm	BP-2527 8.5 mm	BP-2528 10.5 mm



EPSTEIN
BP-2500 - BP-2508
20 cm



HIBBS-SPRATT
BP-2510 - BP-2518
20 cm



HIBBS-SPRATT
BP-2520 - BP-2528
20 cm





BP-2530 1.8 mm	BP-2531 2.2 mm	BP-2532 3.5 mm	BP-2533 4.0 mm	BP-2534 4.5 mm	BP-2535 5.5 mm	BP-2536 7.2 mm	BP-2537 8.5 mm	BP-2538 10.5 mm
BP-2540 1.8 mm	BP-2541 2.2 mm	BP-2542 3.5 mm	BP-2543 4.0 mm	BP-2544 4.5 mm	BP-2545 5.5 mm	BP-2546 7.2 mm	BP-2547 8.5 mm	BP-2548 10.5 mm
BP-2550 1.8 mm	BP-2551 2.2 mm	BP-2552 3.5 mm	BP-2553 4.0 mm	BP-2554 4.5 mm	BP-2555 5.5 mm	BP-2556 7.2 mm	BP-2557 8.5 mm	BP-2558 10.5 mm
BP-2560 1.8 mm	BP-2561 2.2 mm	BP-2562 3.5 mm	BP-2563 4.0 mm	BP-2564 4.5 mm	BP-2565 5.5 mm	BP-2566 7.2 mm	BP-2567 8.5 mm	BP-2568 10.5 mm



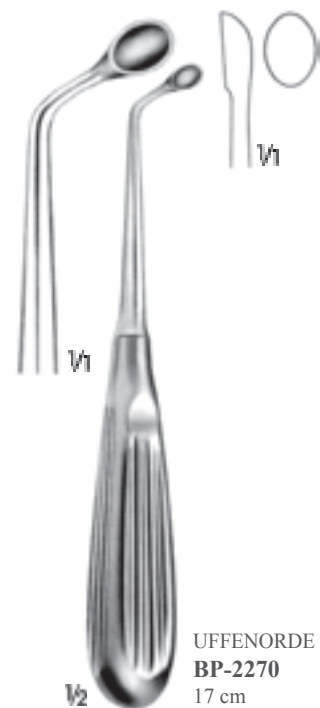
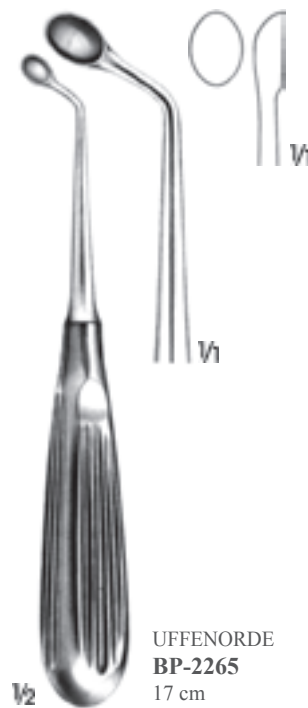



BP-4500 - BP-4804
21.5 cm

Öne/Forward Düz/Straight		0000	000	00	0	1
		0	0	0	0	0
Öne/Forward Açılı/Angle		0000	000	00	0	1
		0	0	0	0	0
Geriye/Backward Düz/Straight		0000	000	00	0	1
		0	0	0	0	0
Geriye/Backward Açılı/Angle		0000	000	00	0	1
		0	0	0	0	0



BP-4900 - BP-5204
24 cm

Öne/Forward Düz/Straight		0000	000	00	0	1
		0	0	0	0	0
Öne/Forward Açılı/Angle		0000	000	00	0	1
		0	0	0	0	0
Geriye/Backward Düz/Straight		0000	000	00	0	1
		0	0	0	0	0
Geriye/Backward Açılı/Angle		0000	000	00	0	1
		0	0	0	0	0



BP-5300 - BP-5702
24 cm

	0	1	2
Geriyeye/Backward Düz/Straight			
	BP-5300	BP-5301	BP-5302

	0	1	2
Geriyeye/Backward Açılı/Angle			
	BP-5500	BP-5501	BP-5502

	0	1	2
Geriyeye/Backward Aşağı/Down			
	BP-5700	BP-5701	BP-5702



BP-5400 - BP-5802
24 cm

	0	1	2
Öne/Forward Düz/Straight			
	BP-5400	BP-5401	BP-5402

	0	1	2
Öne/Forward Açılı/Angle			
	BP-5600	BP-5601	BP-5602

	0	1	2
Öne/Forward Aşağı/Down			
	BP-5800	BP-5801	BP-5802



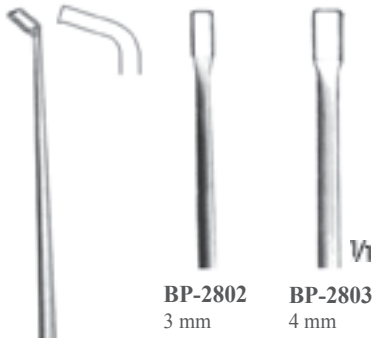

BP-2802
3 mm

BP-2803
4 mm

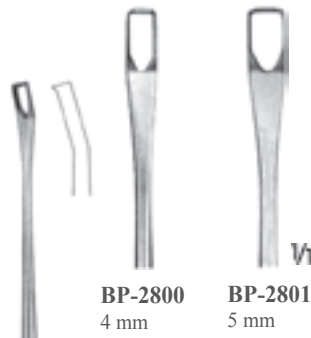

BP-2800
4 mm

BP-2801
5 mm



BP-3206
4 mm

BP-3207
5 mm

BP-3208
6 mm



V2
CASPAR
BP-2802 - BP-2803
Dişli/Toothed
27 cm



V2
CASPAR
BP-2800 - BP-2801
Dişli/Toothed
25 cm



V2
CASPAR
BP-3206 - BP-3208
22 cm

143 ° buhar sterilizatörlerinde steril edilebilir.
Can be sterilized in a steam sterilizer up to 143 °

143° buhar sterilizatörlerinde steril edilebilir.
Can be sterilized in a steam sterilizer up to 143°



Fig.000
BP-3200
3.6 mm
Fig.00
BP-3201
4.4 mm
Fig.0
BP-3202
5.2 mm

CASPAR
BP-3200 - BP-3202
22 cm



Fig.000
BP-3203
3.6 mm
Fig.00
BP-3204
4.4 mm
Fig.0
BP-3205
5.2 mm

CASPAR
BP-3203 - BP-3205
22 cm



BP-3400
2.8 mm
BP-3401
3.6 mm
BP-3402
5.2 mm
BP-3403
10 mm

SYPERT
BP-3400 - BP-3403
38 cm



BP-3404
2.8 mm
BP-3405
3.6 mm
BP-3406
5.2 mm
BP-3407
10 mm

SYPERT
BR-3404 - BR-3407
38 cm





fig. 6

BP-6405
14.5 mm

fig. 5

BP-6404
13 mm

fig. 4

BP-6403
11.5 mm

fig.3

BP-6402
10 mm



fig. 2

BP-6401
8.5 mm

fig. 1

BP-6400
6.8 mm



SIMON
BP-6400 - BP-6405
24 cm

fig. 6

BP-6505
14.5 mm

fig. 5

BP-6504
13 mm

fig. 4

BP-6503
11.5 mm

fig.3

BP-6502
10 mm

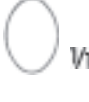

fig. 2

BP-6501
8.5 mm

fig. 1

BP-6500
6.8 mm

SCHRÖDER
BP-6500 - BP-6505
31 cm

BP-6604
14 mm

BP-6603
12 mm



BP-6602
10 mm



BP-6601
8 mm

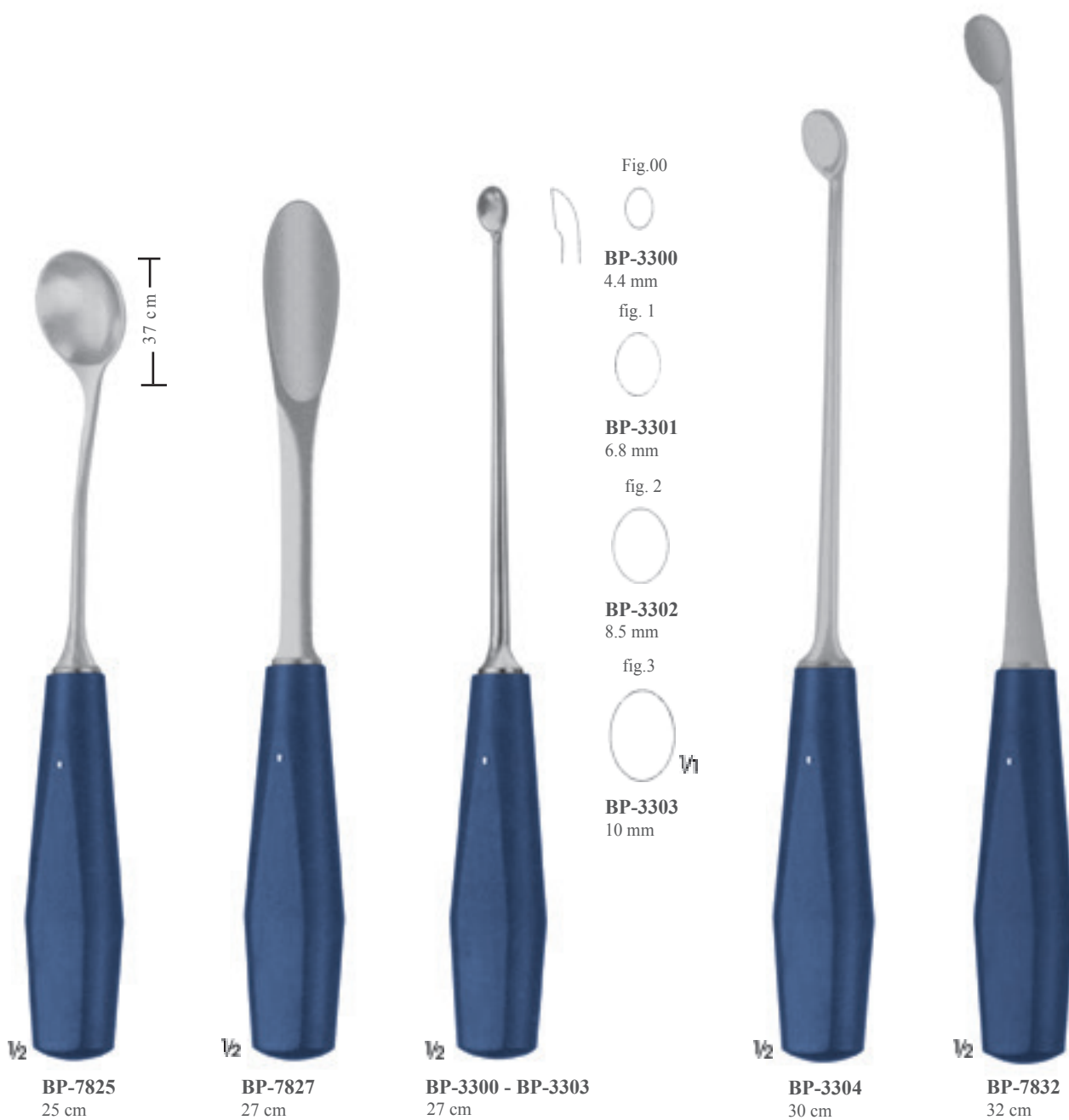

BP-6600
6 mm

GOURDET
BP-6600 - BP-6604
Künt/Blunt
28 cm

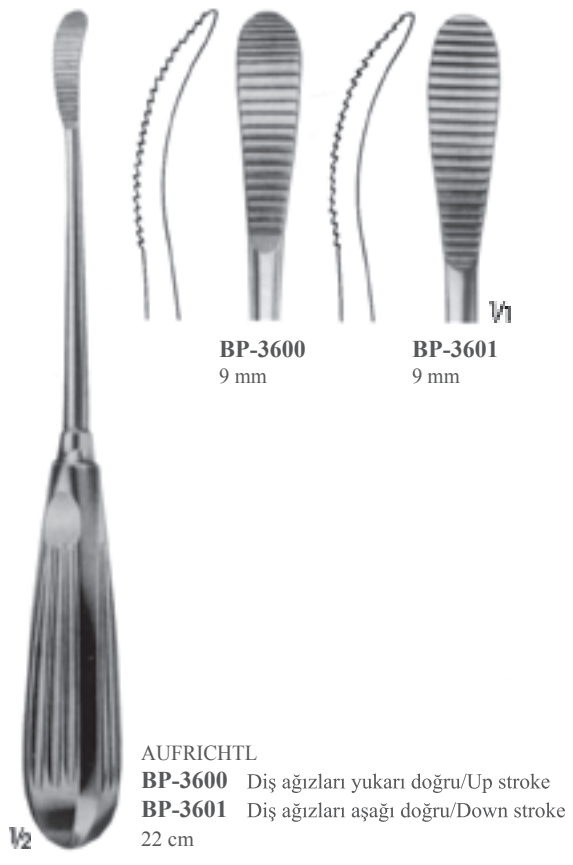
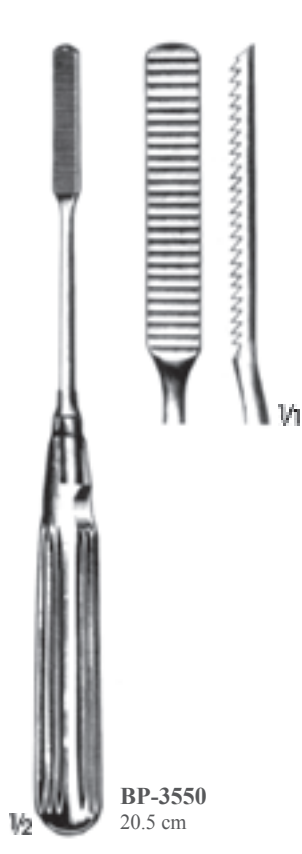
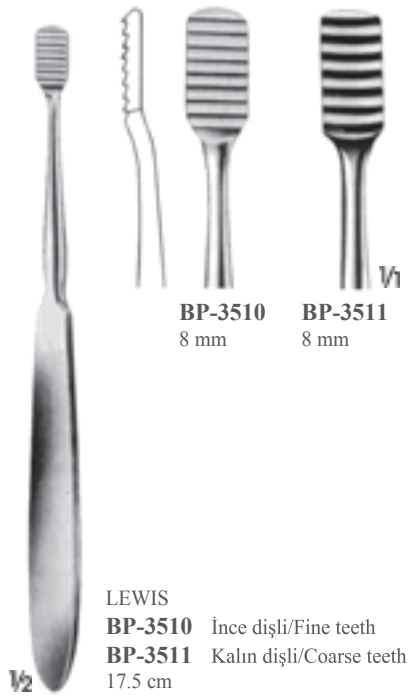
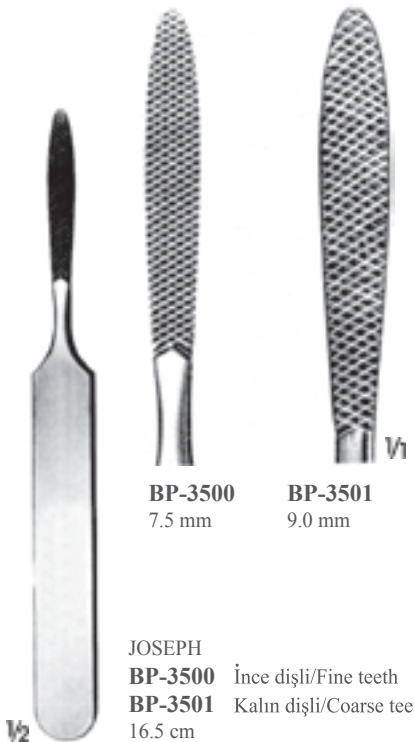
143° buhar sterilizatörlerinde steril edilebilir.
Can be sterilized in a steam sterilizer up to 143°



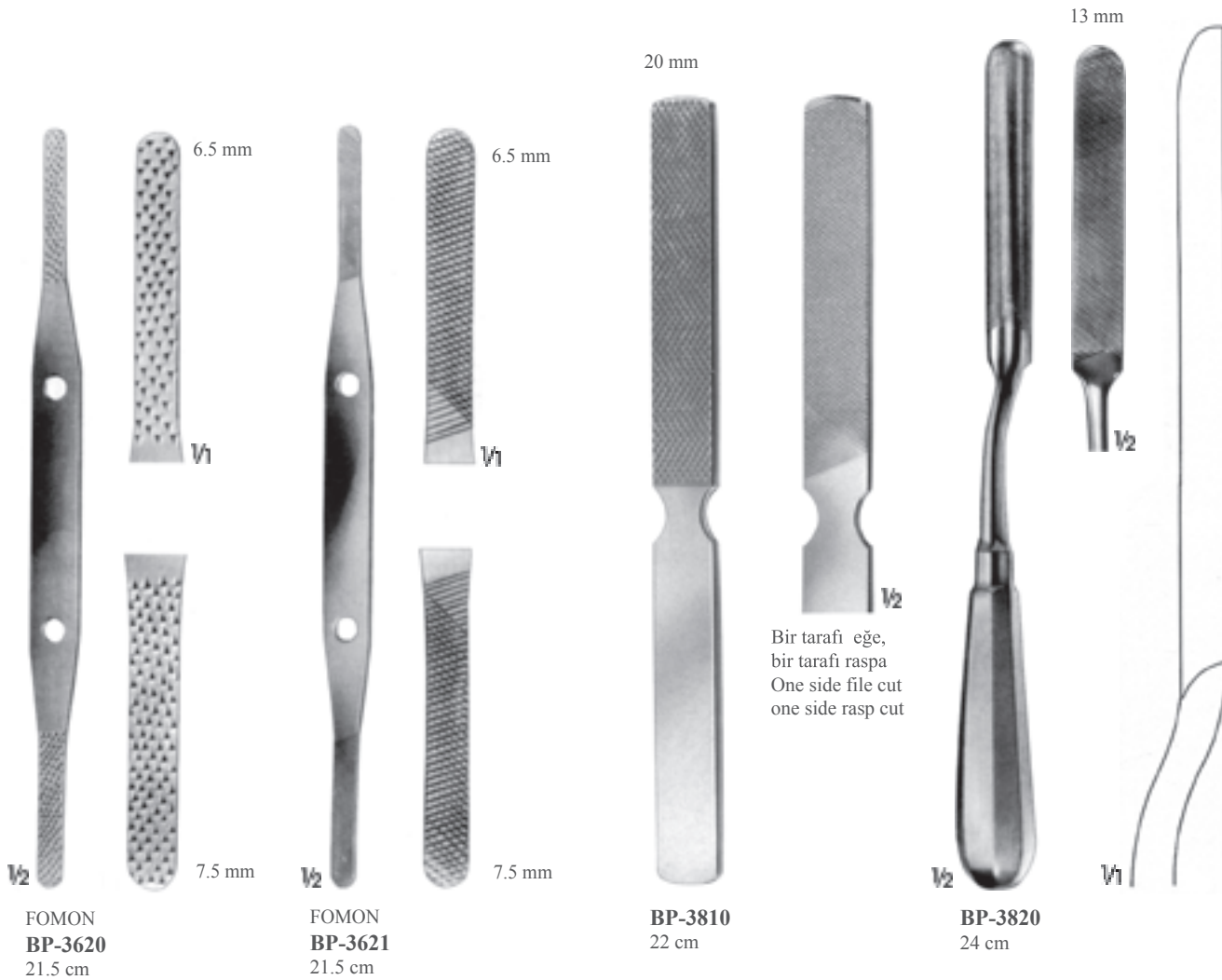
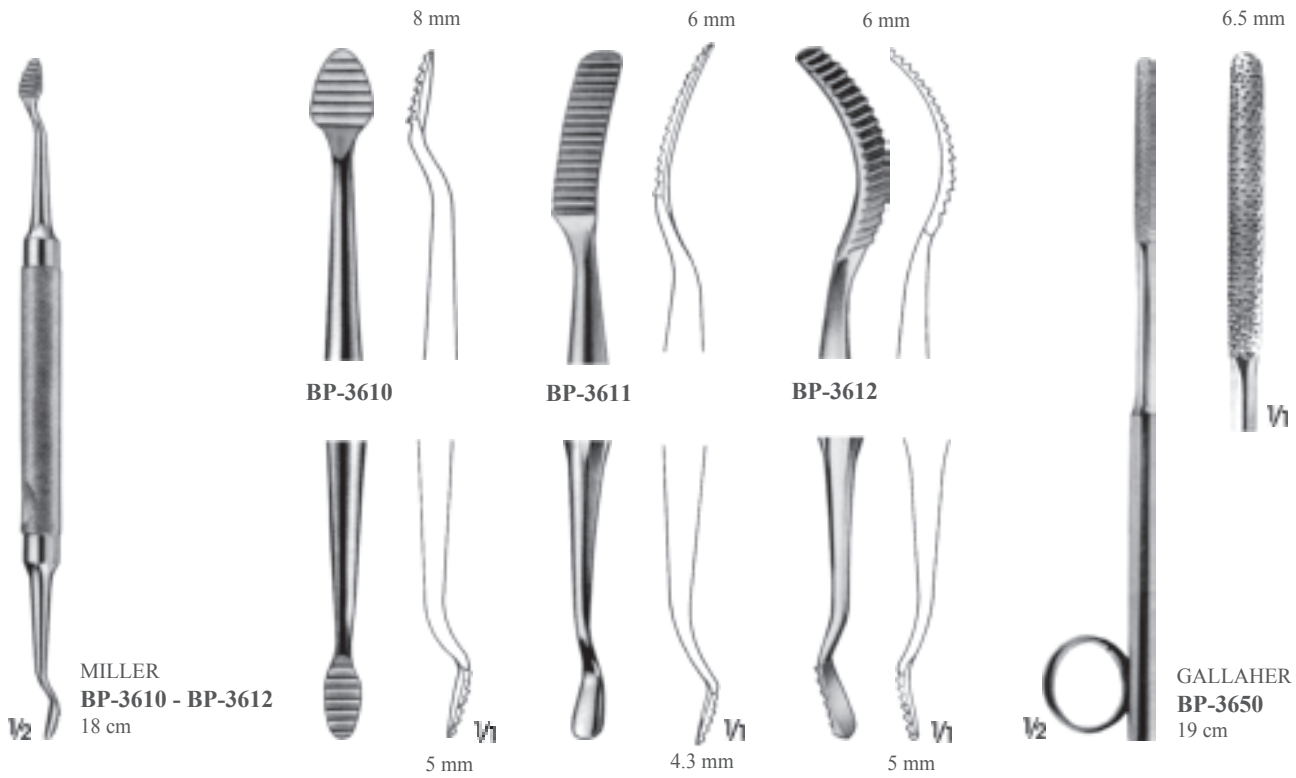





BP-3800 - BP-3804
20.5 cm

Diş
Teeth

7 mm



BP-3800
12/14

7 mm



BP-3801
16/20

7 mm



BP-3802
24/30

7 mm



BP-3803
36/44

7 mm

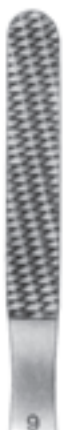

BP-3804
52/62

W1

18 mm



20 mm
PUTTI
BP-3209
27 cm

20 mm



BP-3220
29.5 cm



PUTTI
BP-3210
30 cm



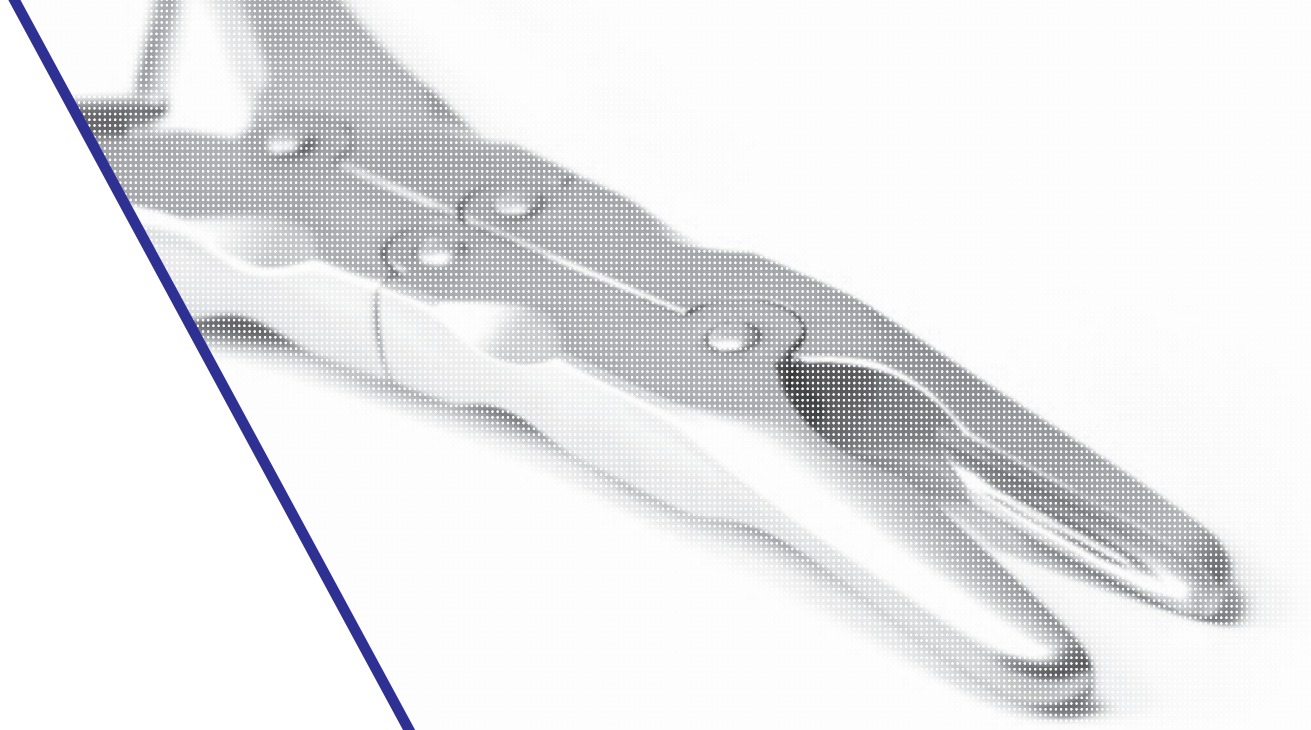

BR

Kemik Pensleri, Ronjurları, Makasları ve Pançları
Bone Holding Forceps, Rongeurs, Scissors and Punches

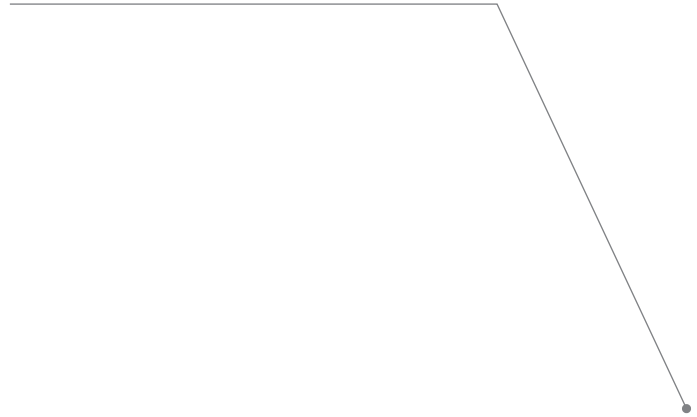



BR-1300
Setli, pozisyon pens
Reposition forceps with
stepped tips
9.5 cm



BR-1310
Küçük parçaları
konumlandırma pens
Reposition forceps for small
fragments
13.5 cm

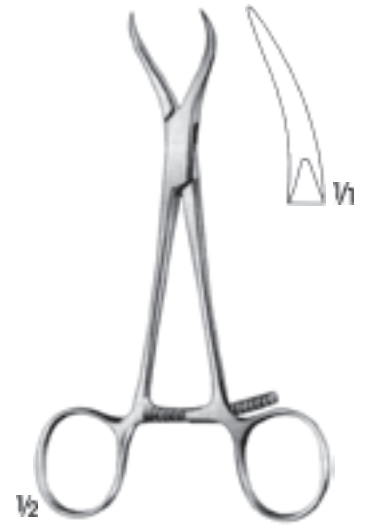

BR-1320
Çene kemiğine ait
konumlandırma pens
Reposition forceps, especially
for maxillary reposition
13.5 cm



**HAASE
BR-1400**
Pozisyon pens, çeneye ait
kırıklar için
Reposition forceps for
mandibular fractures
16.5 cm



**REILL
BR-1410**
Pozisyon pens
Reposition forceps
17 cm



BR-1420
Pozisyon pens
Reposition forceps
20.5 cm





FÖRSTNER
BR-1801
14 cm



BR-1803
13.5 cm



HAASE
BR-1804
14 cm



MEYER
BR-1500
Kişner telleri için matkap kılavuzu,
yeniden konumlandırır
Reposition forceps for fingers,
with drill guide for KIRSCHNER
kullanılan tel Ø 1.0 mm
For wires with Ø 1.0 mm
17 cm



MEYER
BR-1501
Kişner telleri için matkap kılavuzu,
yeniden konumlandırır
Reposition forceps for fingers,
with drill guide for KIRSCHNER
kullanılan tel Ø 2.0 mm
For wires with Ø 2.0 mm
20.5 cm

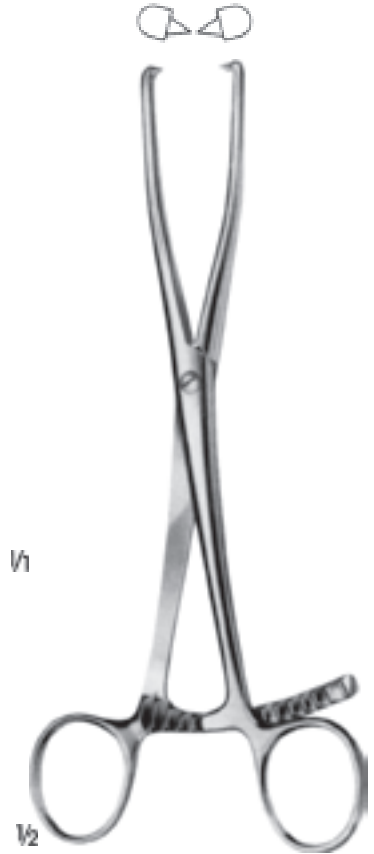

BR-1600
Malleolus pens
Malleolus forceps
21 cm





LEWIN
BR-2250
Kemik klemp
Bone clamp
18.5 cm



BR-1700
Diz kapağı pensi
Patella forceps
18.5 cm



BR-2020
Sekestrum pensi
Sequestrum forceps
20 cm

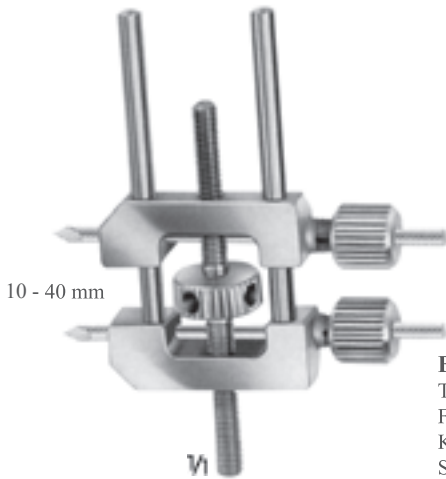

10 - 40 mm

BV-2653
Tel Ø 3.0 mm
For wires Ø 3.0 mm
Küçük kemikleri yaklaştırma aparatı
Small bones of the zoom apparatus



Ø 2 mm

Vidalanabilir kemik parçasını
KIRSCHNER teli kullanarak sabitleme
Position, Re-giver bony part of the wire
can be screwed KIRSCHNER
stabilization using

WÖRRLEIN
BV-2663
Pozisyon verici
Repositioner
16.5 cm



DINGMANN
BR-1900
18.5 cm



DINGMANN
BR-1901
18.5 cm



SEMB
BR-2200
19 cm



SEMB
BR-2201
19 cm





1/2

BR-2255
Kilitlenebilir, sabitlenebilir pens
Forceps with ratchet fixation
14 cm



1/2

BR-2300
Vida ile sabitlenebilir pens
Forceps with thread fixation
17 cm



1/2

BR-2301
Vida ile sabitlenebilir pens
Forceps with thread fixation
23.5 cm



1/2

BR-2450
Kemik tutma pens
Bone holding forceps
20 cm



1/2

LANGENBECK
BR-2455
Kemik tutma pens
Bone holding forceps
20.5 cm



1/2

FERGUSON
BR-2460
Kemik tutma pens
Bone holding forceps
20.5 cm

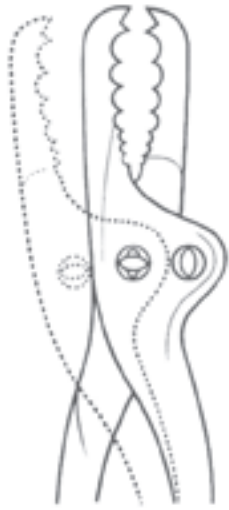

Ayarlanabilir ağız
Jaw adjustable



FARABEU
BR-2465
23cm



FARABEU
BR-2470
25.5 cm



FARABEU-LAMBOTTE
BR-2475
25.5 cm







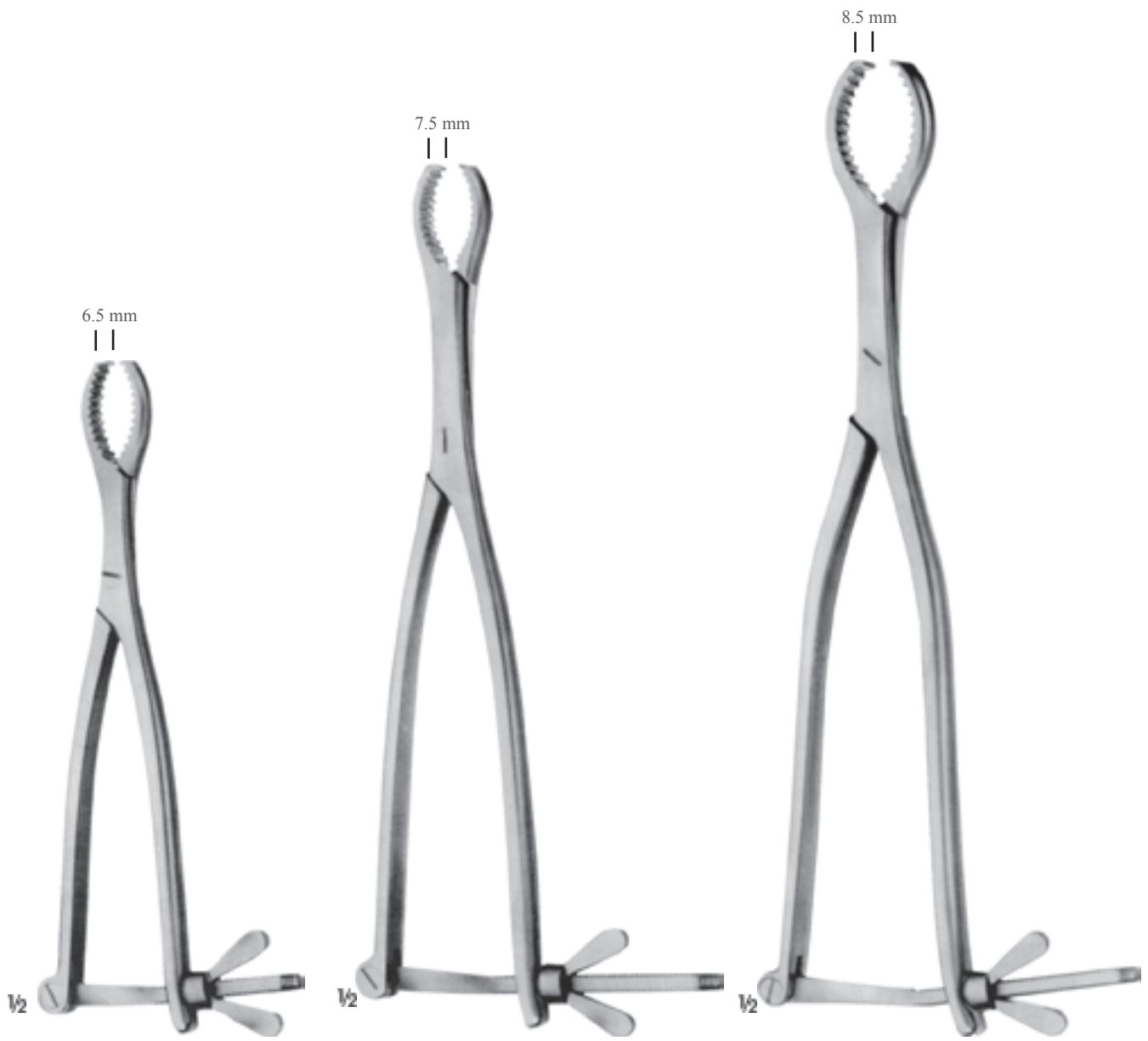

HEY GROVES
BR-2700
21 cm

HEY GROVES
BR-2701
27 cm

HEY GROVES
BR-2702
30.5 cm

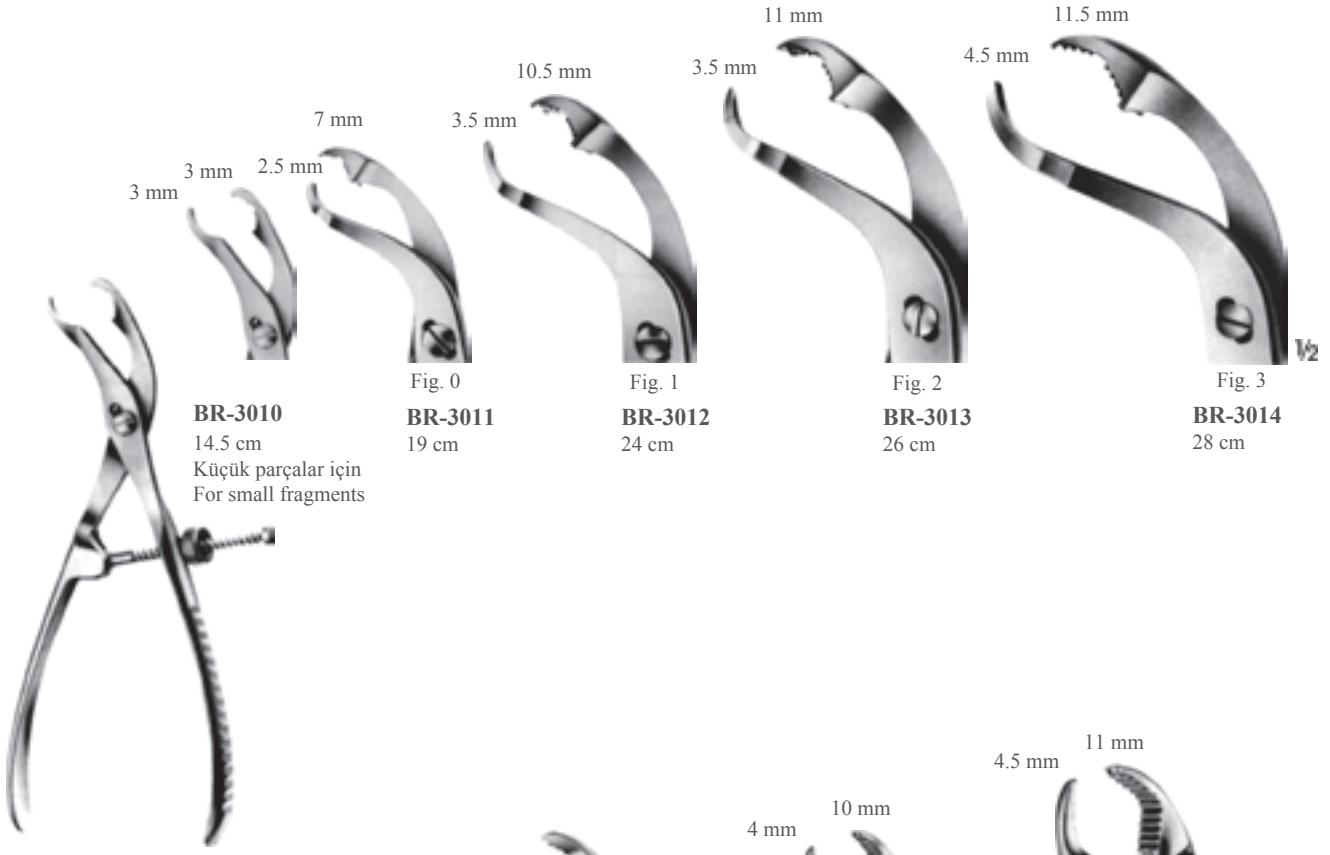

BR-3010
14.5 cm
Küçük parçalar için
For small fragments

BR-3011
19 cm

BR-3012
24 cm

BR-3013
26 cm

BR-3014
28 cm

BR-3010 - BR-3014
Kendi kendini merkezleyici,
vidalı sabit pensler
Self-centering forceps with
thread fixation



VERBRUGGE
BR-3100
17.5 cm

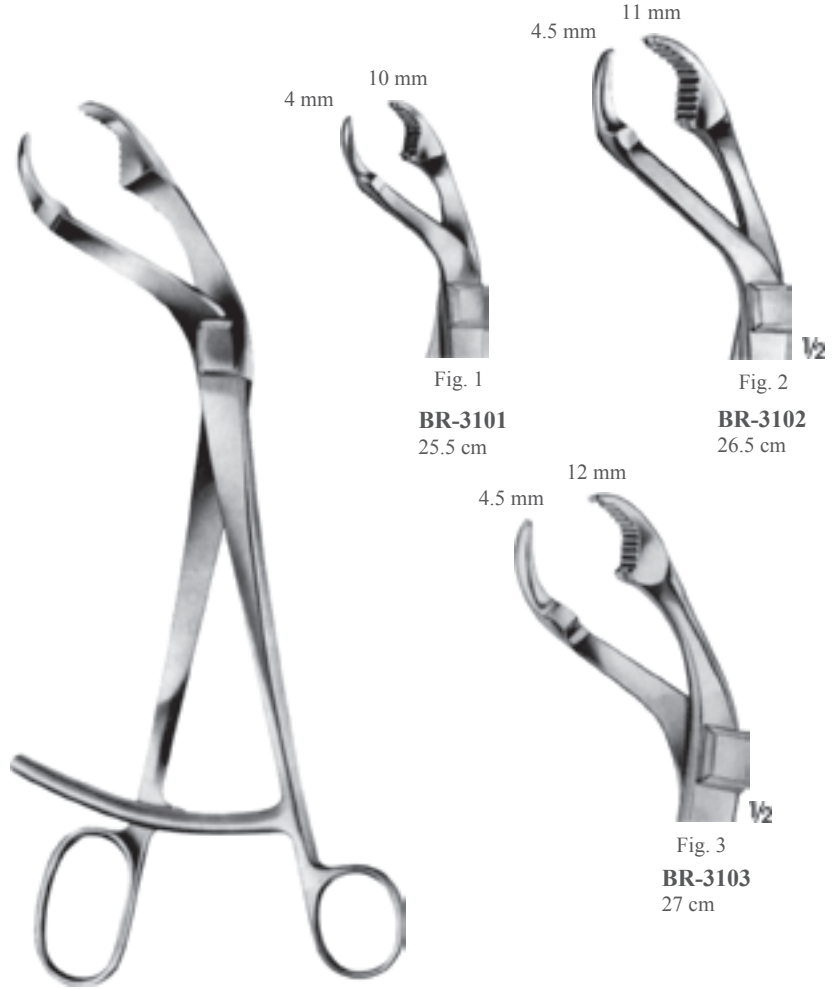

BR-3101
25.5 cm

BR-3102
26.5 cm

BR-3103
27 cm

VERBRUGGE
BR-3101 - BR-3103
Eklemli ağız/With lip joint





Haraketli çene
Movable jaw



BR-3200
22 cm



BR-3201
26 cm



BR-3202
33 cm

LAMBOTTE
BR-3200 - BR-3202

Ayarlanabilir çene
Adjustable jaw

Haraketli çene
Movable jaw



BR-3300
21.5 cm

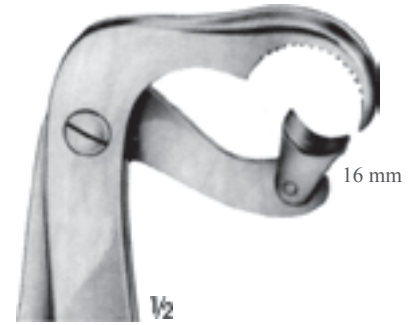

BR-3301
27.5 cm

BR-3300 - BR-3301



LOWMAN
BR-3400 17 cm
BR-3401 20.5 cm



LOWMAN-GERSTER
BR-3410
21 cm



LOWMAN-HOGLUND
BR-3420
17.5 cm

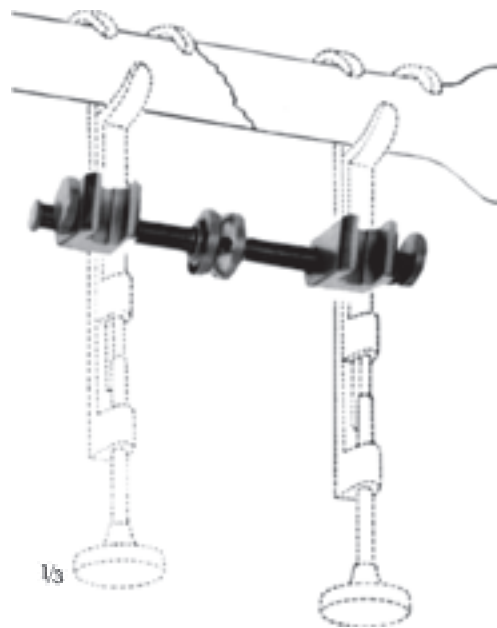

GERSTER
BR-3450
BR-3400 - BR-3420 için çekirme çubuğu
Traction bar for BR-3400 - BR-3420







LUER-FRIEDMANN
BR-3825
Kemik Ronjur/Bone Rongeur
14.5 cm



BR-3830
14 cm



LUER
BR-3835
15 cm



LUER
BR-3836
15.5 cm



BLUMENTHAL
BR-3840
15.5 cm

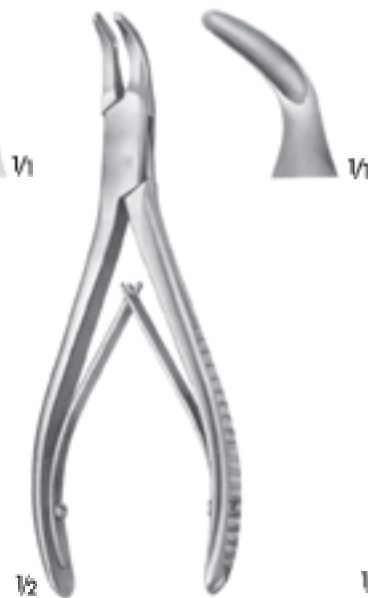

BLUMENTHAL
BR-3841
15 cm

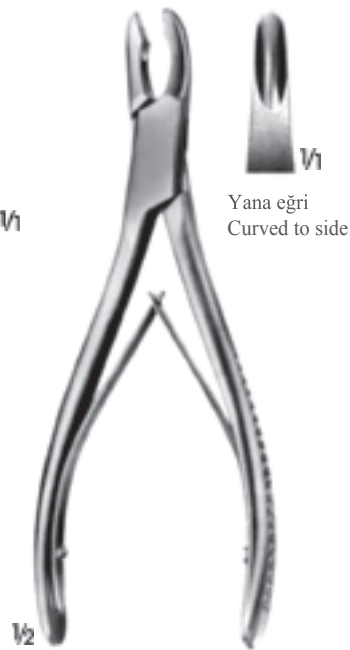

HAKANSSON
BR-3855
17 cm

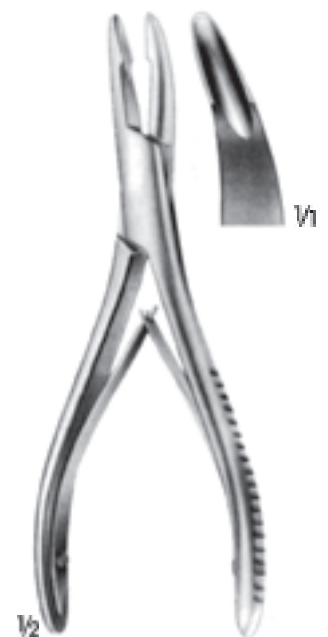

MEAD
BR-3860
16.5 cm





JANSEN
BR-3870
17.5 cm



JANSEN
BR-3871
17.5 cm

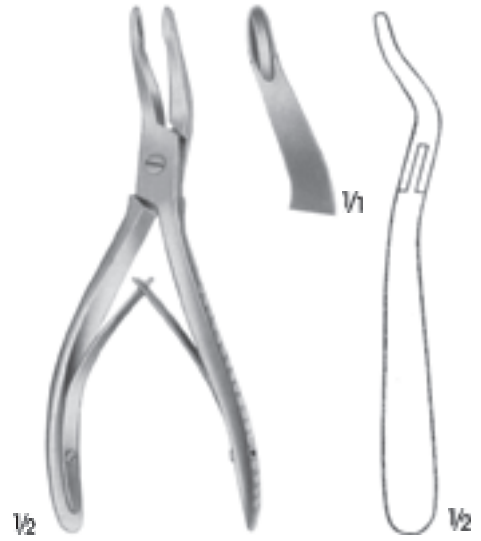

ALEXANDER
BR-3880
14 cm

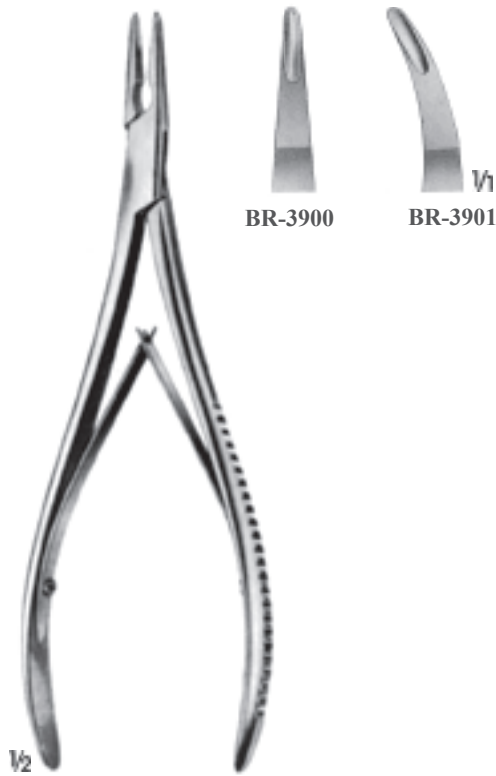

LEMPERT
BR-3900 - BR-3901
20 cm



JANSEN
BR-3885
19 cm



BANE-HARTMANN
BR-3875
17.5 cm



LUER
BR-3940
18 cm



LUER
BR-3941
18 cm



BEYER
BR-3890
18 cm



LUER
BR-3920 - BR-3921
17.5 cm



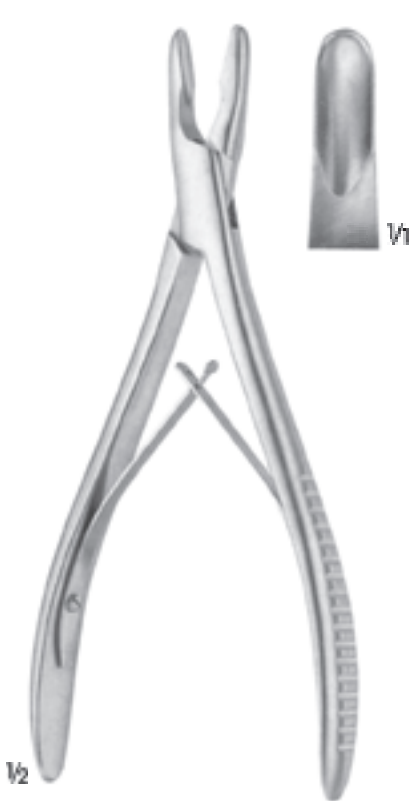

ADSON
BR-4055
20 cm



NORTHFIELD
BR-4080
21 cm

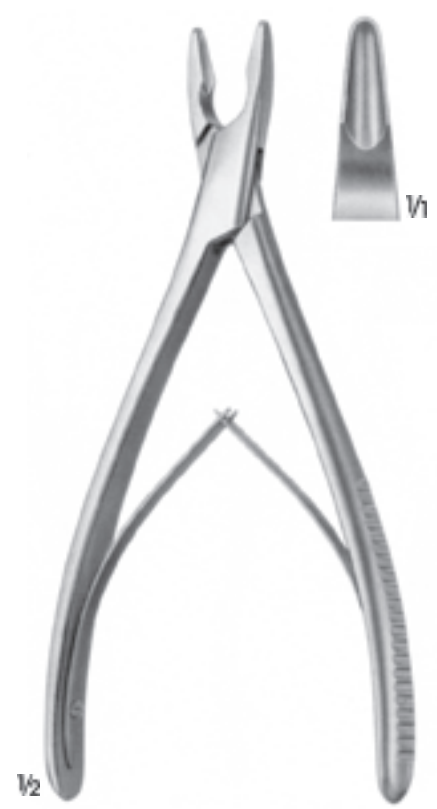

PENNYBACKER
BR-4070
20.5 cm



TROTTER
BR-3955
20.5 cm



GULEKE
BR-3950
20.5 cm



OLIVECRONA
BR-3945
20.5 cm



BÖHLER
BR-3960 - BR-3961
15.5 cm



MAYFIELD
BR-3975
17.5 cm



BEYER
BR-3965
ZUFAL-JANSEN
BR-3970
18 cm



RUSKIN
BR-3985
19 cm



MARQUARDT
BR-3980
20 cm



RÖTTGEN-RUSKIN
BR-3990
24 cm



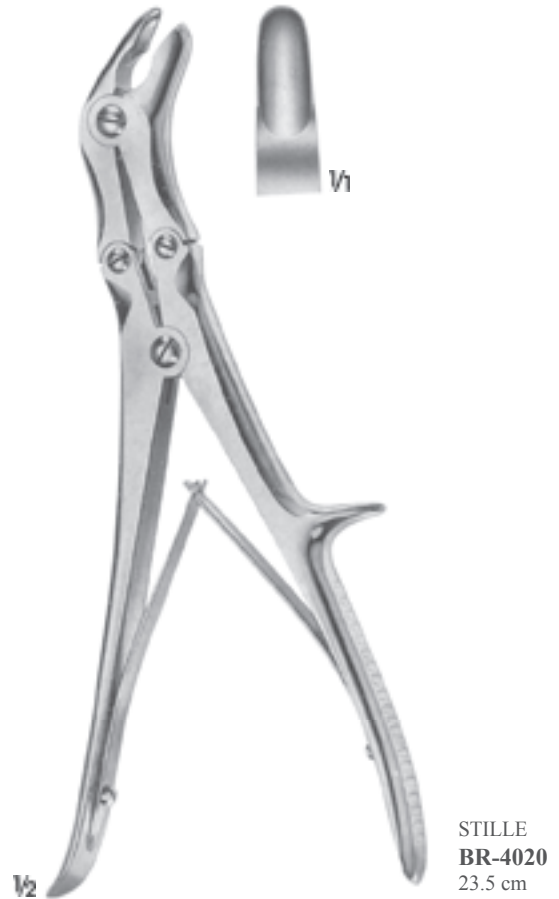
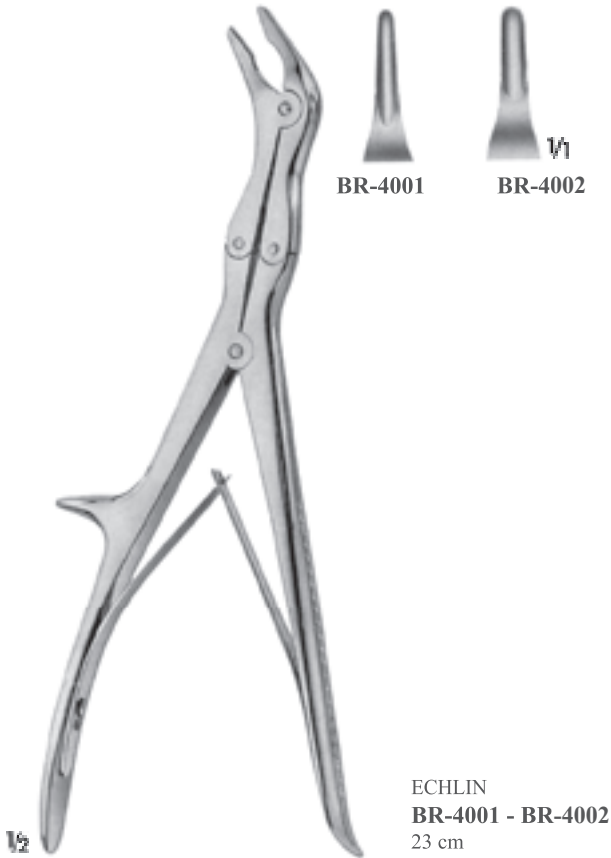



LEKSELL-STILLE
BR-4030
24 cm



STILLE-RUSKIN
BR-4040
24 cm



LUER-STILLE
BR-4045
22.5 cm



LUER-STILLE
BR-4050
22.5 cm





SEM B
BR-4060
24 cm



LUER-STILLE
BR-4065
27 cm



SAUERBRUCH-CORYLLOS
BR-4090 - BR-4091
31 cm



SYPERT
BR-4100
36 cm





BR-4313
13 cm



**STAMM
BR-4320**
15 cm



BR-4317
17 cm

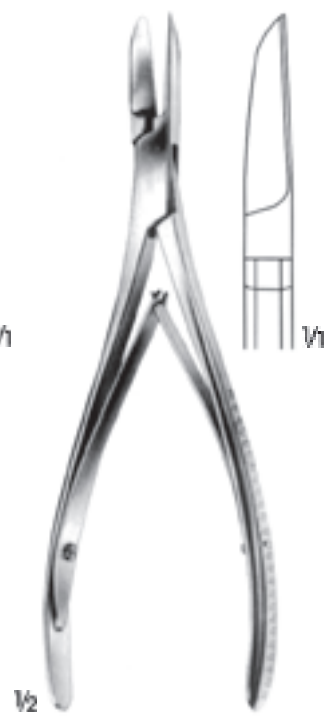

**KAZANJIAN
BR-4330**
18.5 cm



BR-4402
20 cm

BR-4403
22 cm



BR-4410
17 cm

BR-4411
20 cm

BR-4412
22 cm



**LISTON
BR-4400 - BR-4403**



**LISTON
BR-4410 - BR-4412**



BÖHLER
BR-4500
14.5 cm



BÖHLER
BR-4501
14.5 cm

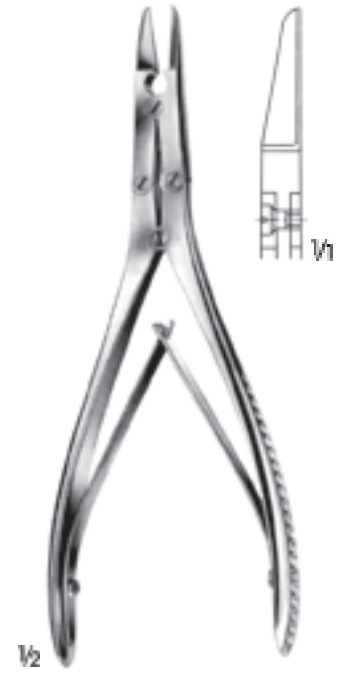

BR-4510
17 cm



MC INDOE
BR-4515
17.5 cm



RUSKIN-LISTON
BR-4520
19 cm



RUSKIN-LISTON
BR-4521
19 cm





LISTON
BR-4530
Düz eğimli/Curved on flat
24 cm

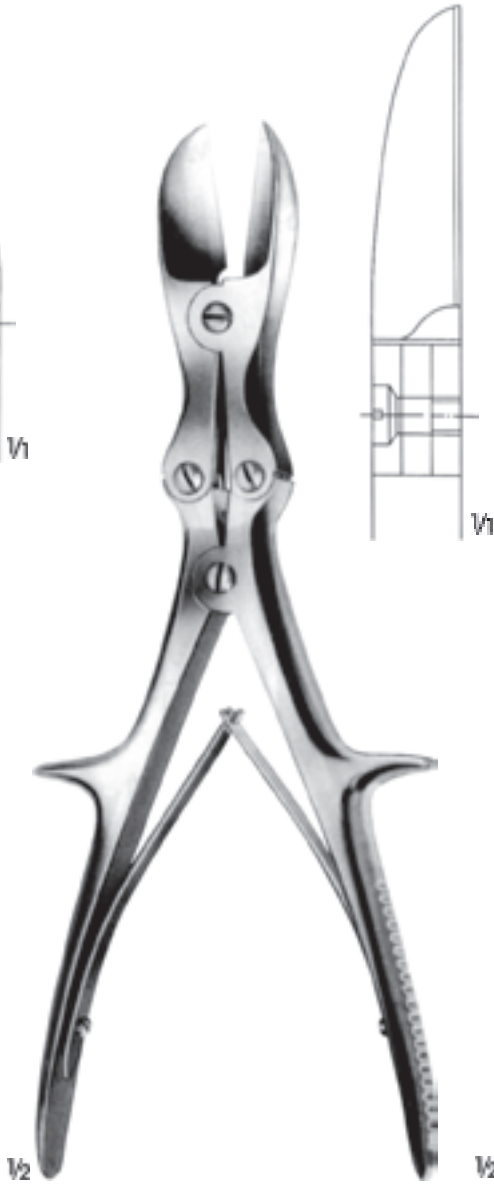

LISTON
BR-4531
Düz/Straight
28 cm

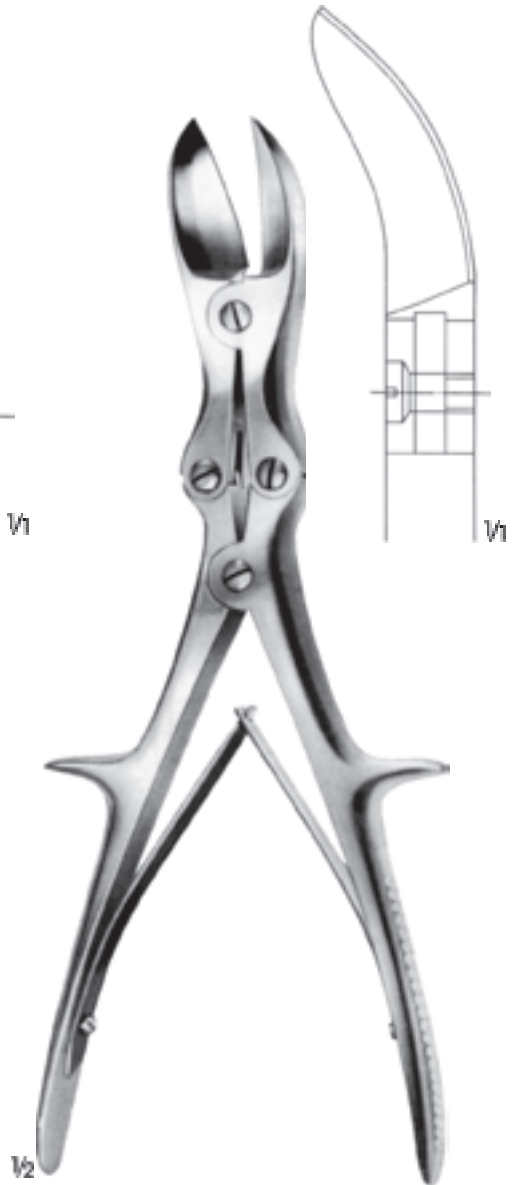

LISTON
BR-4532
Düz eğimli/Curved on flat
28 cm

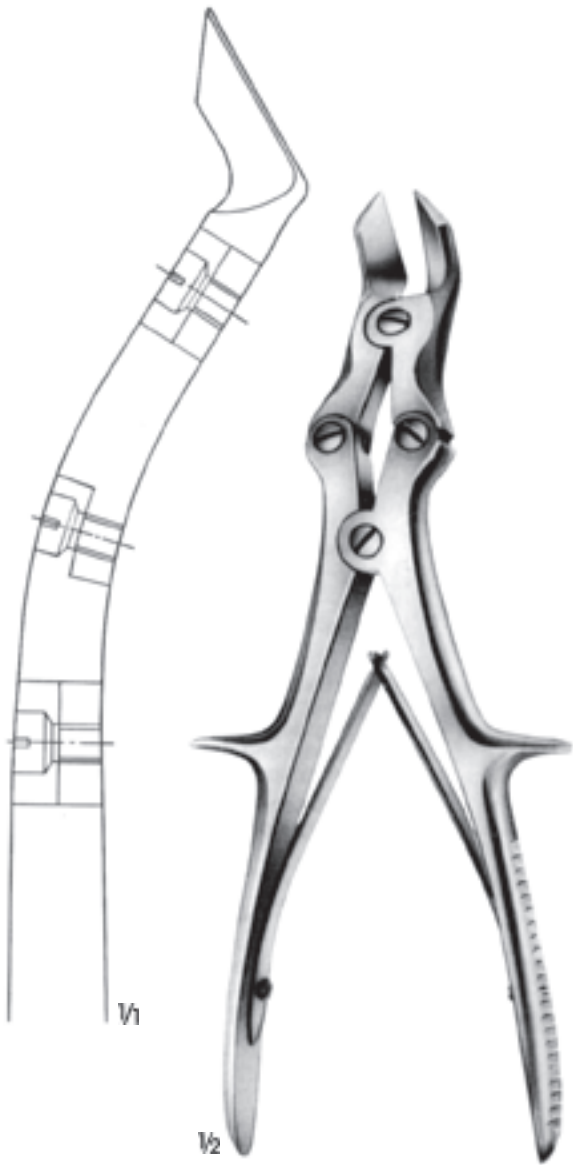

LISTON-KEY-HORSLEY
BR-4545
25.5 cm



LISTON-STILLE
BR-4540
26.5 cm

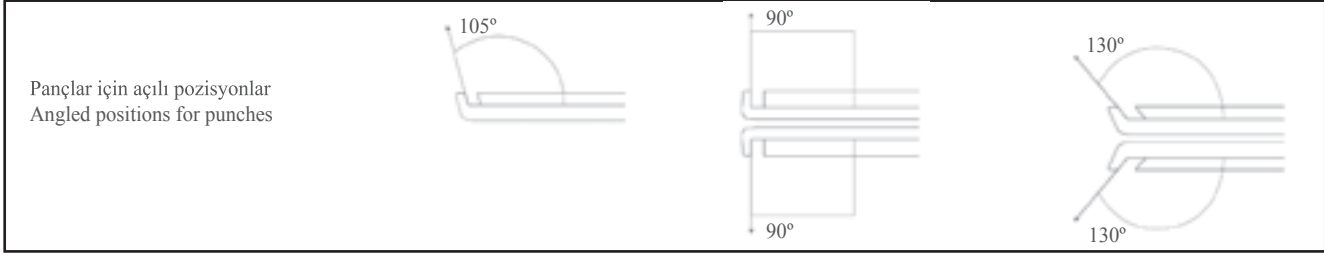

BR-4703 3 mm



BR-4704 4 mm



BR-4705 5 mm

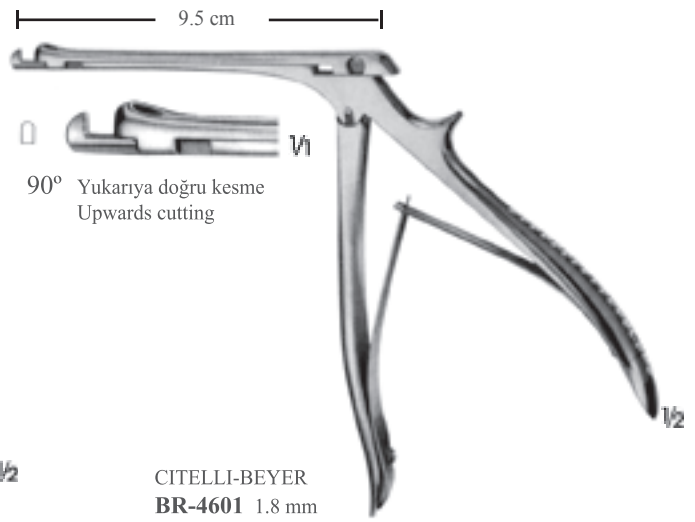
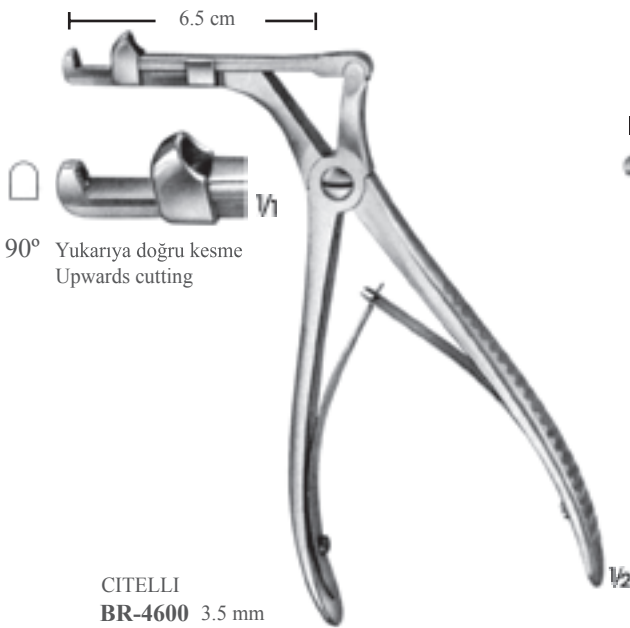

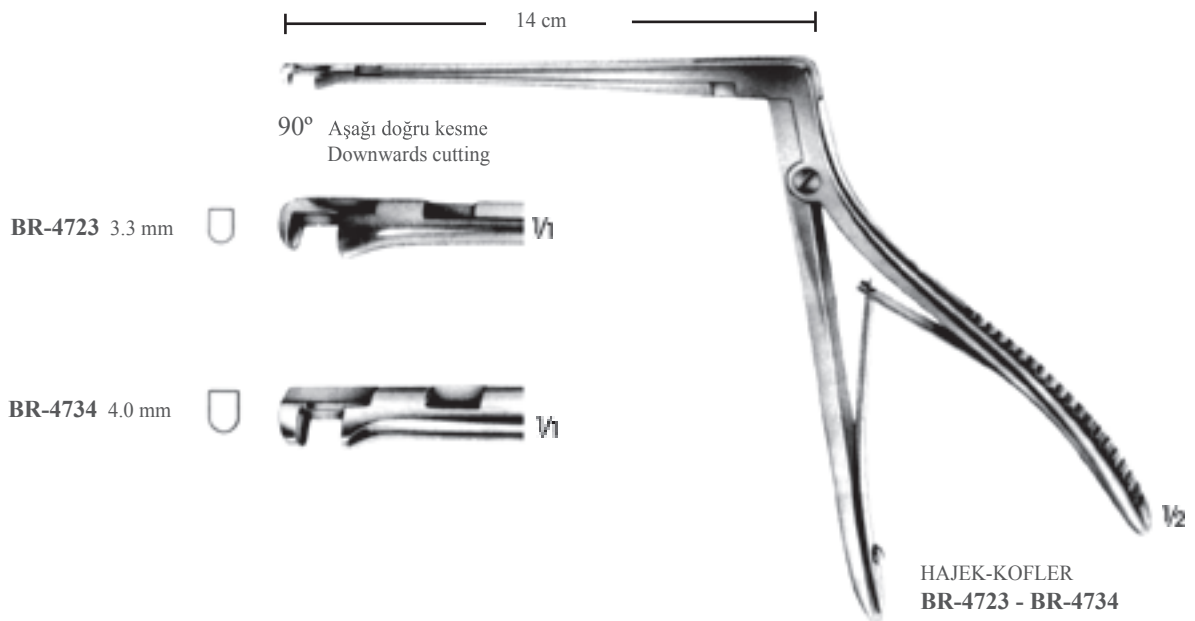
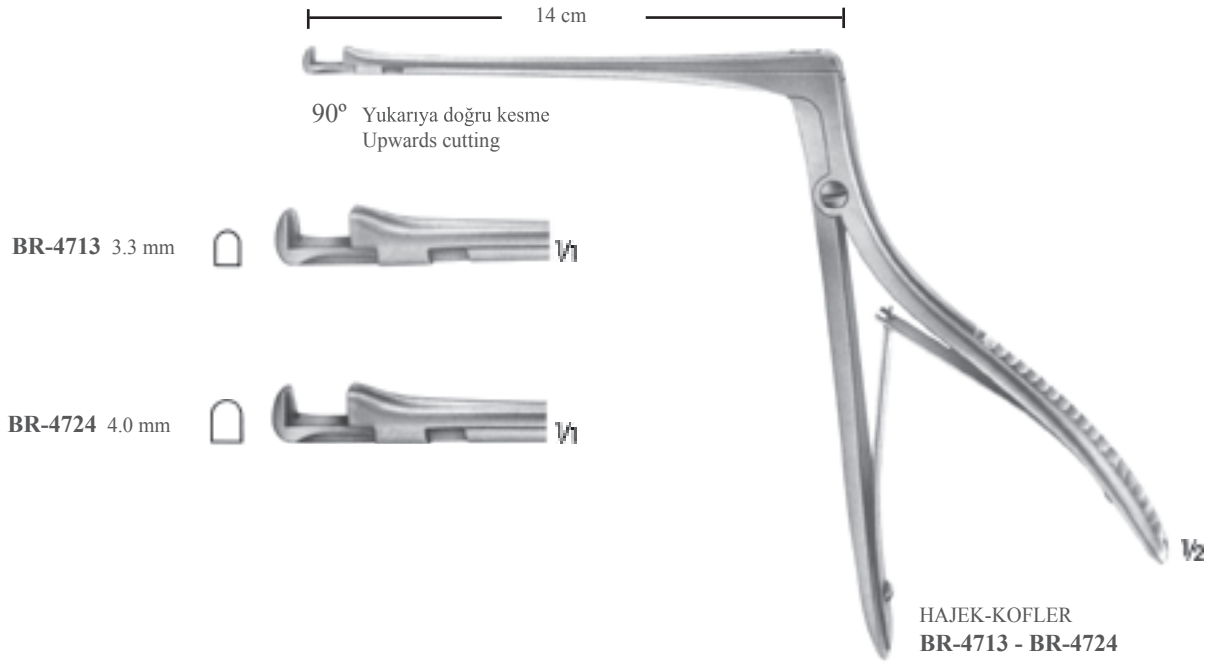



BR-4714 4.0 mm

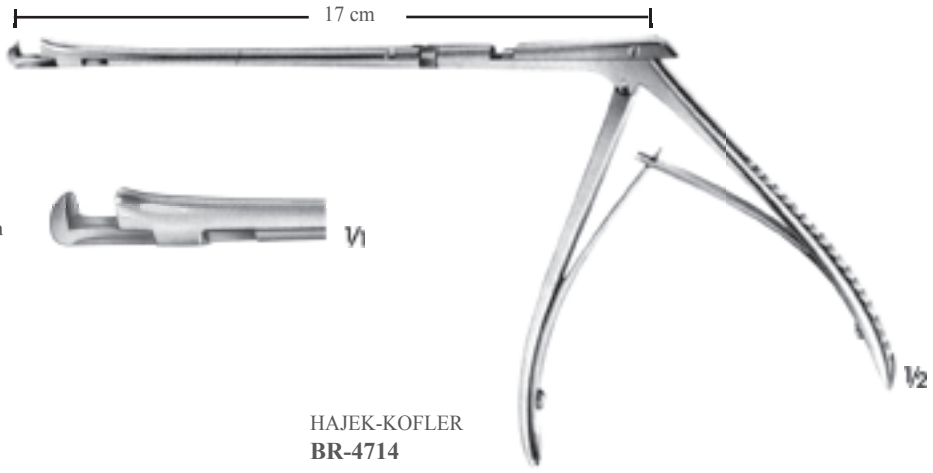

HAJEK-KOFLER
BR-4714

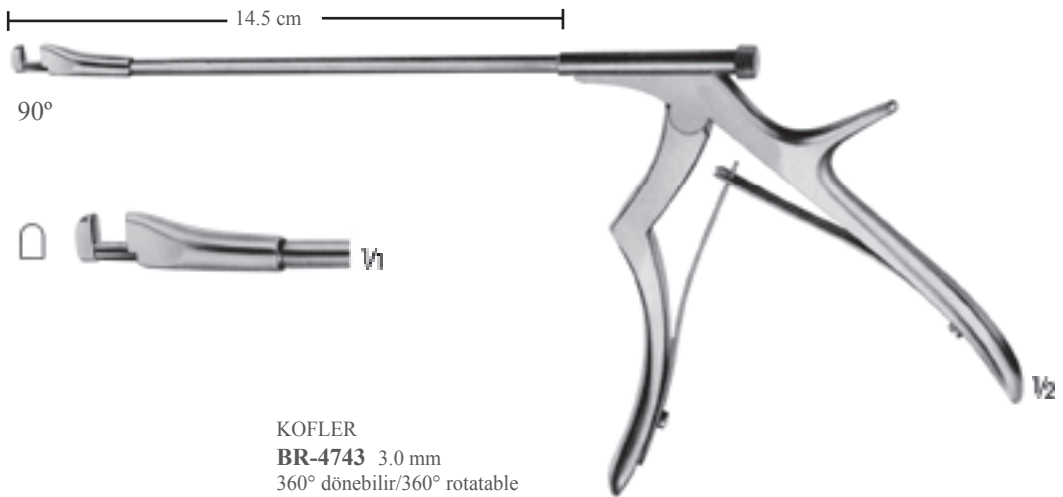

KOFLER
BR-4743 3.0 mm
360° dönebilir/360° rotatable



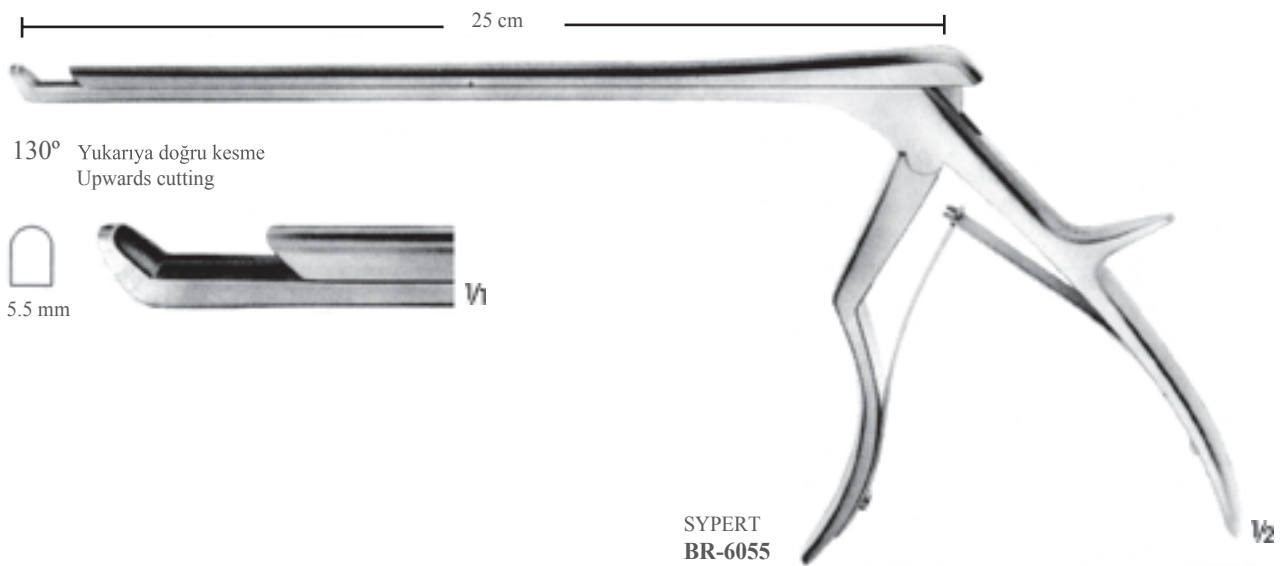
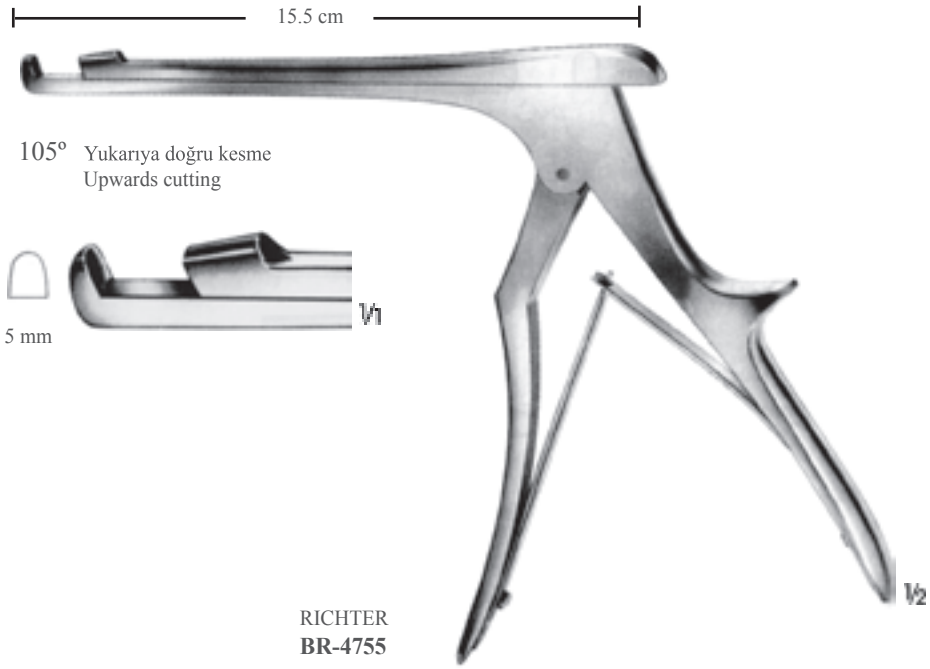



130° Yukarıya doğru kesme/Upwards cutting



Standart ağız tabanlı
Standard footplate



Ince ağız tabanlı
With thin footplate



Standart ağız tabanlı
Standard footplate



Ince ağız tabanlı
With thin footplate

Ayrılabilir/Detachable

Boy Length	En Width	Ejektör Ejector	Ayrılabilir/Detachable				
18 cm	1 mm	-		BR-9401	BR-9931	BR-9501	BR-9941
18 cm	2 mm	-		BR-9402	BR-9932	BR-9502	BR-9942
18 cm	3 mm	+		BR-9403	BR-9933	BR-9503	BR-9943
18 cm	4 mm	+		BR-9404	BR-9934	BR-9504	BR-9944
18 cm	5 mm	+		BR-9405	BR-9935	BR-9505	BR-9945
18 cm	6 mm	+		BR-9406	-	BR-9506	-
20 cm	1 mm	-	-	-	BR-9951	-	BR-9961
20 cm	2 mm	-		BR-9602	BR-9952	BR-9702	BR-9962
20 cm	3 mm	+		BR-9603	BR-9953	BR-9703	BR-9963
20 cm	4 mm	+		BR-9604	BR-9954	BR-9704	BR-9964
20 cm	5 mm	+		BR-9605	BR-9955	BR-9705	BR-9965
20 cm	6 mm	+		BR-9606	-	BR-9706	-
23 cm	2 mm	-		BR-9802	BR-9972	BR-9902	BR-9982
23 cm	3 mm	+		BR-9803	BR-9973	BR-9903	BR-9983
23 cm	4 mm	+		BR-9804	BR-9974	BR-9904	BR-9984
23 cm	5 mm	+		BR-9805	BR-9975	BR-9905	BR-9985

90° Yukarıya doğru kesme/Upwards cutting



Standart ağız tabanlı
Standard footplate

HARDBLACK



Standart ağız tabanlı
Standard footplate



Standart ağız tabanlı
Standard footplate

Boy Length	En Widht	Ayrılabilir/Detachable		Standart/Standard		
		Ejektör Ejector				
18 cm	1 mm		-			
				BR-8901	BR-9001	BR-5001
18 cm	2 mm		-			
				BR-8902	BR-9002	BR-5002
18 cm	3 mm		+			
				BR-8903	BR-9003	BR-5003
18 cm	4 mm		+			
				BR-8904	BR-9004	BR-5004
18 cm	5 mm		+			
				BR-8905	BR-9005	BR-5005
18 cm	6 mm		+			
				BR-8906	BR-9006	BR-5006
23 cm	2 mm		-			
				BR-9102		
23 cm	3 mm		+			
				BR-9103		
23 cm	4 mm		+			
				BR-9104		
23 cm	5 mm		+			
				BR-9105		

90° Aşağıya doğru kesme/Downwards cutting

Boy Length	En Widht	Ayrılabilir/Detachable		Standart/Standard	
		Ejektör Ejector			
18 cm	1 mm		-		
				BR-9201	BR-5201
18 cm	2 mm		-		
				BR-9202	BR-5202
18 cm	3 mm		+		
				BR-9203	BR-5203
18 cm	4 mm		+		
				BR-9204	BR-5204
18 cm	5 mm		+		
				BR-9205	BR-5205
18 cm	6 mm		+		
				BR-9206	BR-5206
23 cm	2 mm		-		
				BR-9302	
23 cm	3 mm		+		
				BR-9303	
23 cm	4 mm		+		
				BR-9304	
23 cm	5 mm		+		
				BR-9305	





130° Aşağıya doğru kesme/Downwards cutting



Standart ağız tabanlı
Standard footplate

Ince ağız tabanlı
With thin footplate

Standart ağız tabanlı
Standard footplate

Ince ağız tabanlı
With thin footplate

Ayrılabilir/Detachable

Standart/Standard



Boy Length	En Widht	Ejektör Ejector				
18 cm	1 mm	□ -	BR-9911	BR-9991	BR-5101	BR-5501
18 cm	2 mm	□ -	BR-9912	BR-9992	BR-5102	BR-5502
18 cm	3 mm	□ +	BR-9913	BR-9993	BR-5103	BR-5503
18 cm	4 mm	□ +	BR-9914	BR-9994	BR-5104	BR-5504
18 cm	5 mm	□ +	BR-9915	BR-9995	BR-5105	BR-5505
21.5 cm	2 mm	□ -			BR-5802	
21.5 cm	3 mm	□ -			BR-5803	
21.5 cm	4 mm	□ +			BR-5804	
21.5 cm	5 mm	□ +			BR-5805	
23 cm	2 mm	□ -	BR-9922		BR-7502	
23 cm	3 mm	□ +	BR-9923		BR-7503	
23 cm	4 mm	□ +	BR-9924		BR-7504	
23 cm	5 mm	□ +	BR-9925		BR-7505	

130° Yukarıya doğru kesme/Upwards cutting























Standart ağız tabanlı
Standard footplate



Ince ağız tabanlı
With thin footplate

Standart/Standard



Boy Length	En Widht			
18 cm	1 mm		BR-4901	BR-5301
18 cm	2 mm		BR-4902	BR-5302
18 cm	3 mm		BR-4903	BR-5303
18 cm	4 mm		BR-4904	BR-5304
18 cm	5 mm		BR-4905	BR-5305
18 cm	6 mm		BR-4906	-
20 cm	1 mm		-	BR-6101
20 cm	2 mm		BR-5902	BR-6102
20 cm	3 mm		BR-5903	BR-6103
20 cm	4 mm		BR-5904	BR-6104
20 cm	5 mm		BR-5905	BR-6105
20 cm	6 mm		BR-5906	-
21.5 cm	2 mm		BR-5702	
21.5 cm	3 mm		BR-5703	
21.5 cm	4 mm		BR-5704	
21.5 cm	5 mm		BR-5705	
23 cm	2 mm		BR-7402	BR-6902
23 cm	3 mm		BR-7403	BR-6903
23 cm	4 mm		BR-7404	BR-6904
23 cm	5 mm		BR-7405	BR-6905



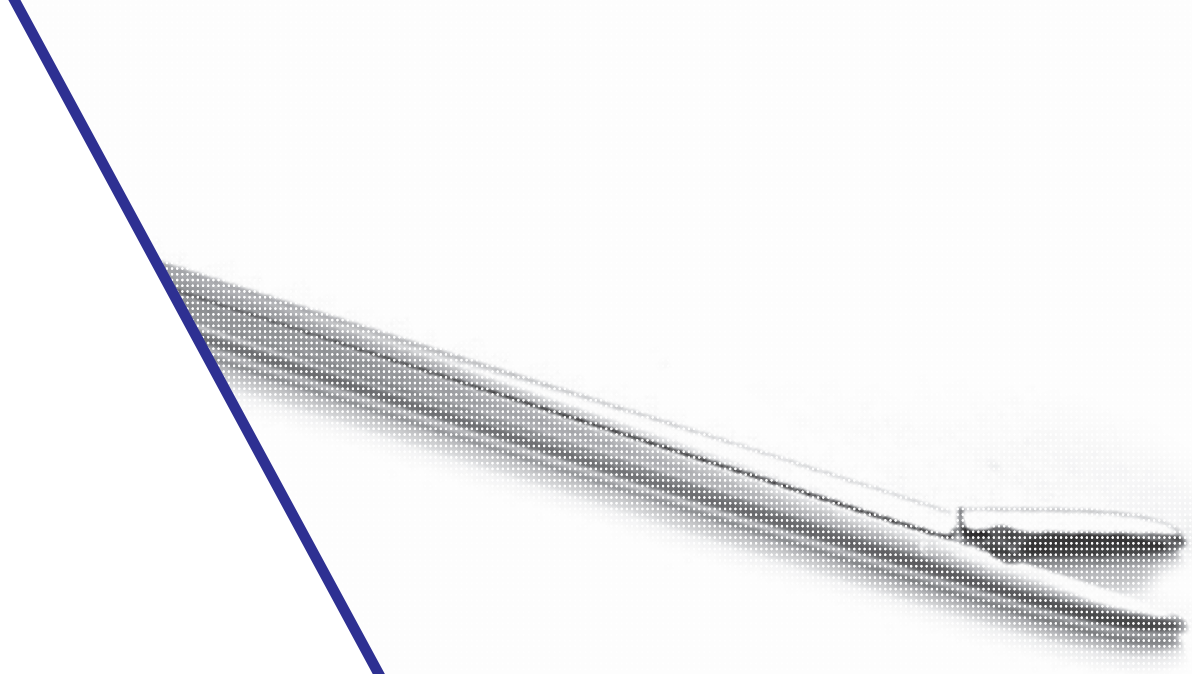

BS

Ronjurlar
Rongeurs





HEYMANN
BS-2270
18 cm

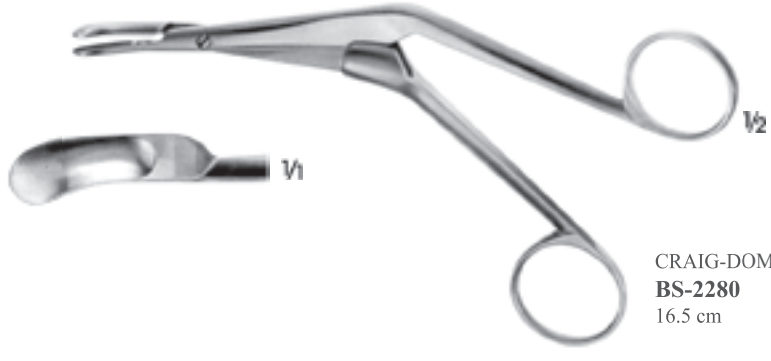

CRAIG-DOMNICK
BS-2280
16.5 cm

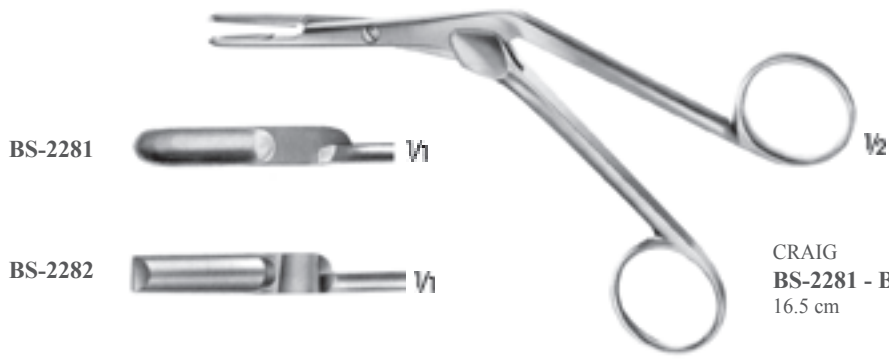

CRAIG
BS-2281 - BS-2282
16.5 cm



HEMANN-KNIGHT
BS-2285
19 cm

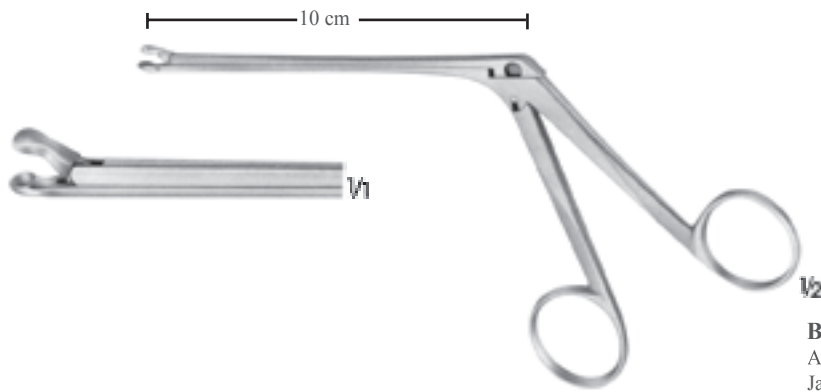

BS-2360
Ağız Ø 3 mm
Jaw Ø 3 mm



IRWIN MOORE
BS-2300
19 cm



BRÜNINGS
BS-2290 - BS-2293
19 cm



BS-2310



LUC
BS-2310 - BS-2311
20 cm





Pançlar için açılı pozisyonlar
Angled positions for punches

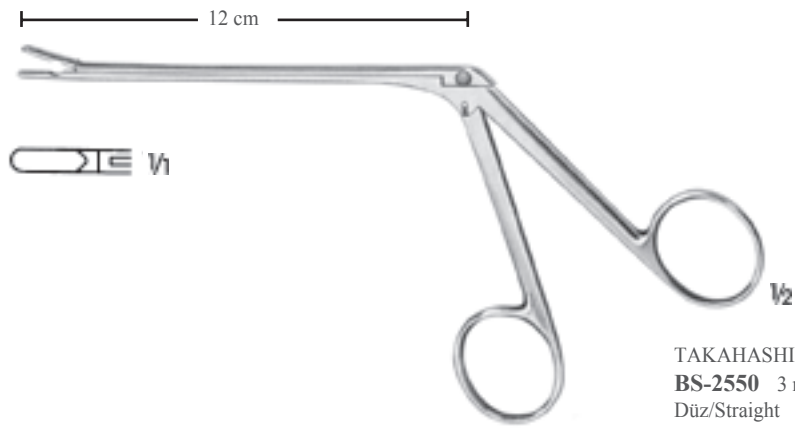
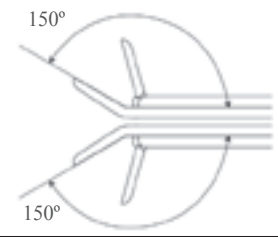
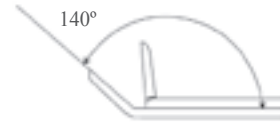
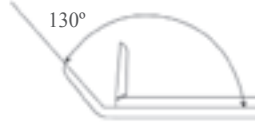

TAKAHASHI
BS-2550 3 mm
Düz/Straight

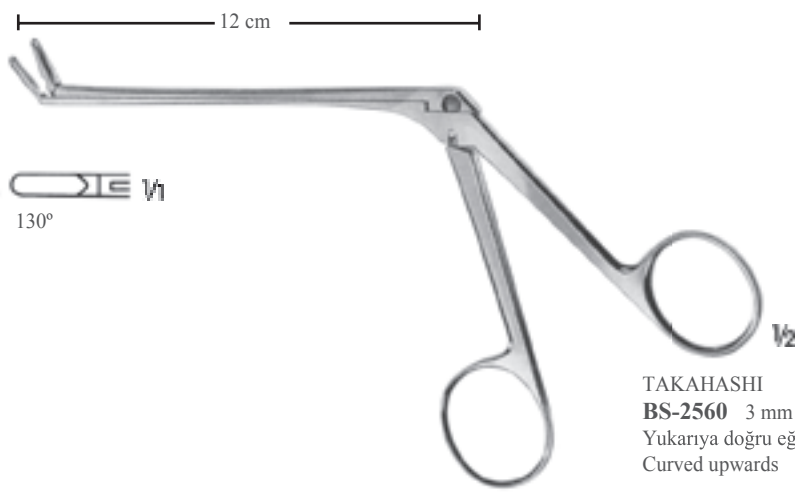

TAKAHASHI
BS-2560 3 mm
Yukarıya doğru eğri
Curved upwards

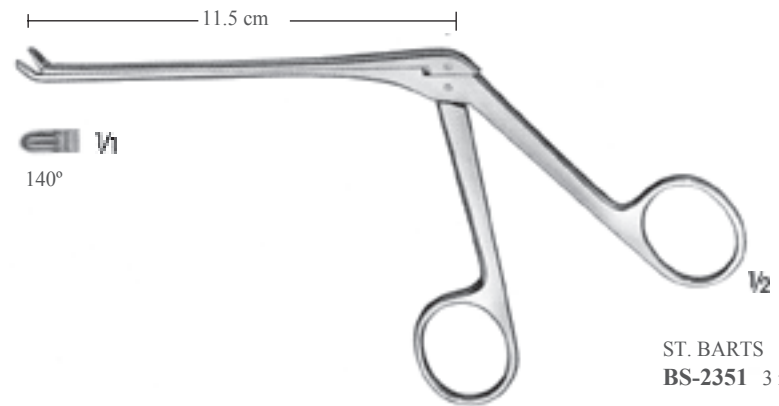

ST. BARTS
BS-2351 3 mm

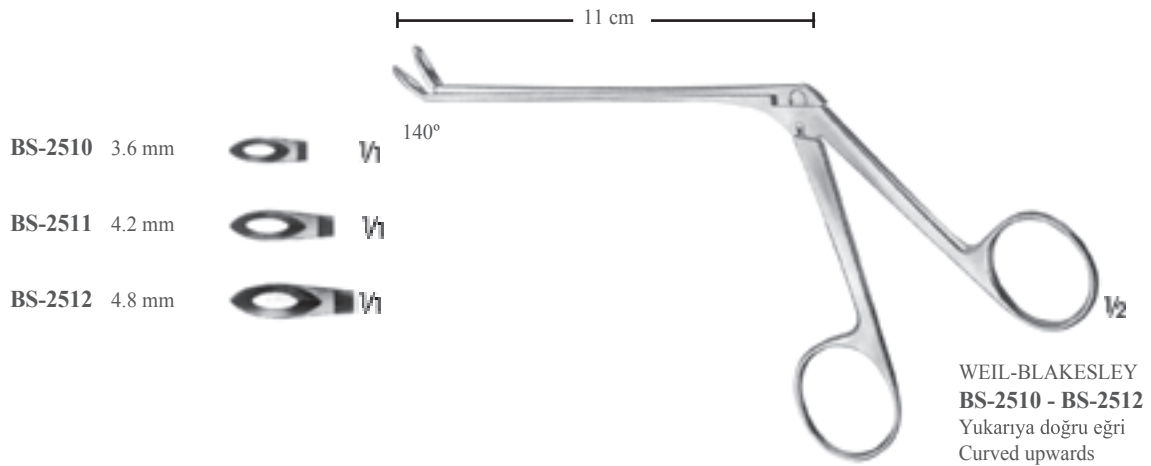
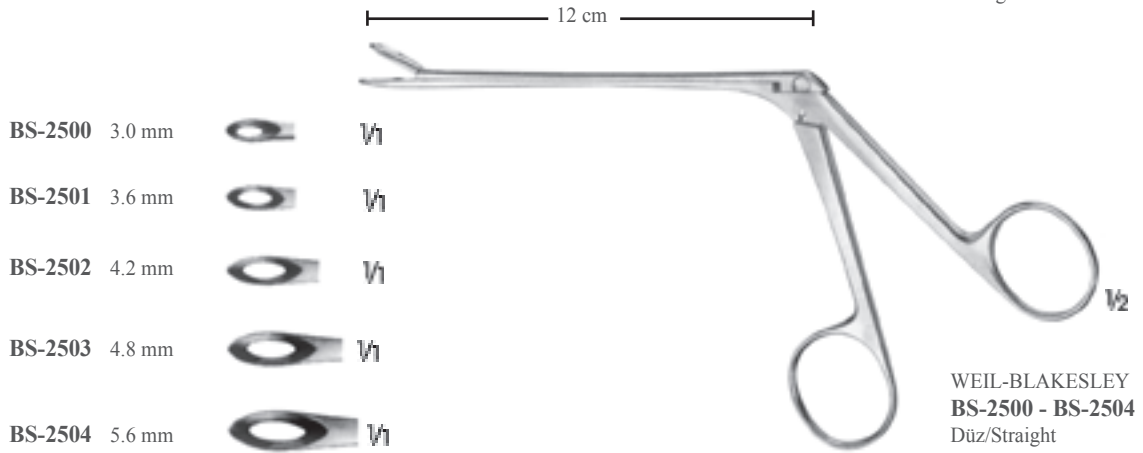
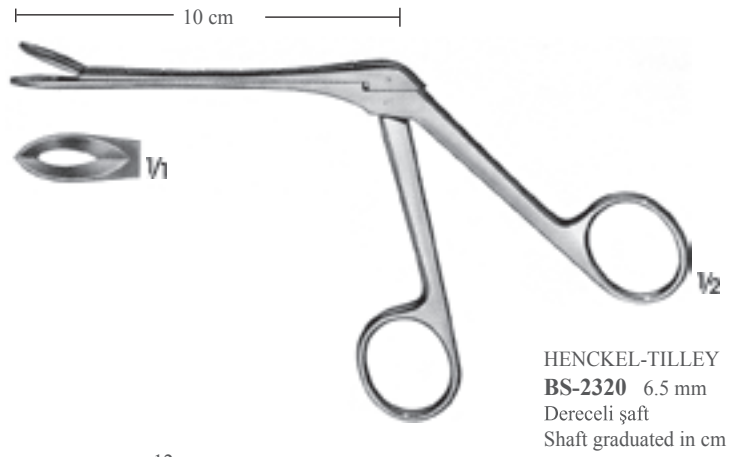



11.5 cm



ST. BARTS
BS-2350 3 mm

13 cm



BECK
BS-4762 2 mm

12.5 cm



PENNYBACKER
BS-5103 3 mm

CUSHING

BS-4804 4 mm

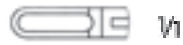

BS-4805 5 mm



BS-4806 6 mm

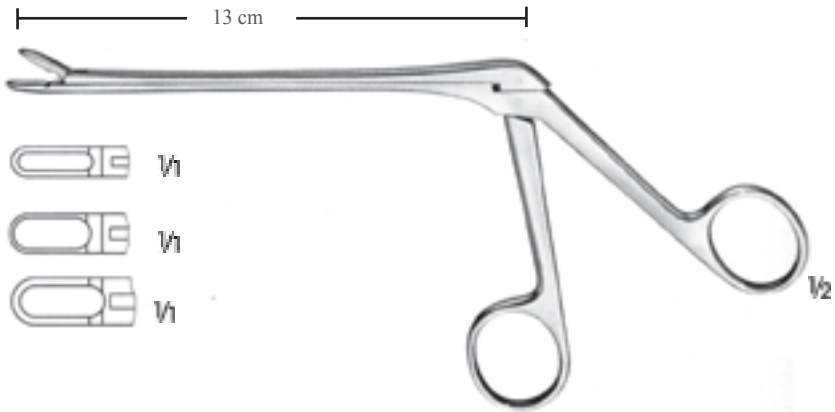

CUSHING

BS-4903 3 mm



BS-4904 4 mm



BS-4905 5 mm



150°

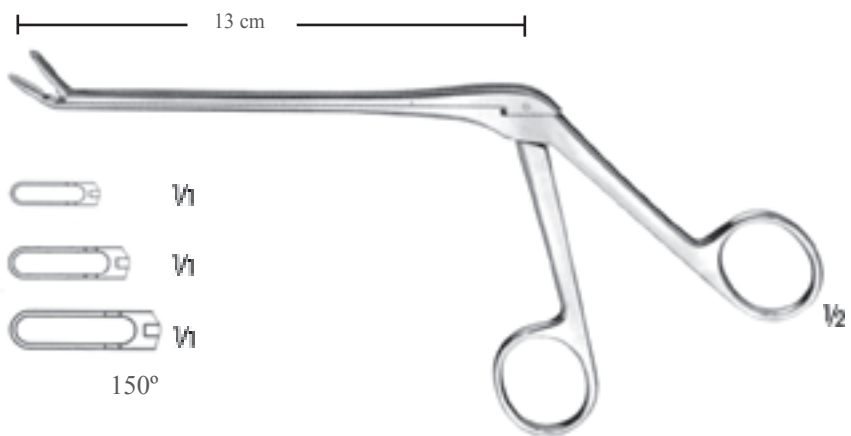

CUSHING

BS-5003 3 mm



BS-5004 4 mm



150°

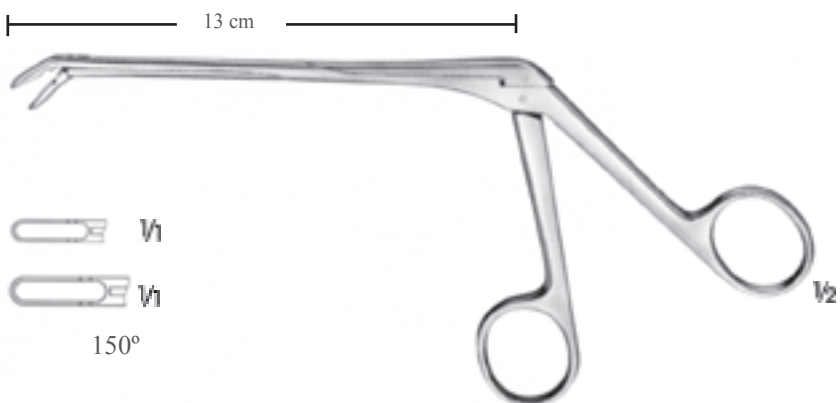



15 cm

BS-2802 2 mm $\frac{1}{16}$

BS-2803 3 mm $\frac{1}{16}$

BS-2804 4 mm $\frac{1}{16}$

BS-2805 5 mm $\frac{1}{16}$

CASPAR
BS-2802 - BS-2805

15 cm

BS-2902 2 mm $\frac{1}{16}$

BS-2903 3 mm $\frac{1}{16}$

BS-2904 4 mm $\frac{1}{16}$

150°

CASPAR
BS-2902 - BS-2904

15 cm

BS-3002 2 mm $\frac{1}{16}$

BS-3003 3 mm $\frac{1}{16}$

BS-3004 4 mm $\frac{1}{16}$

150°

CASPAR
BS-3002 - BS-3004
Alt çene hareketli
Lower part of jaw movable

LOVE-GRUENWALD
BS-2602 2 x 10 mm



LOVE-GRUENWALD
BS-2603 3 x 10 mm



SPURLING
BS-2604 4 x 10 mm



CUSHING
BS-3102 2 x 10 mm



LOVE-GRUENWALD
BS-3203 3 x 10 mm

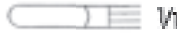

SPURLING
BS-3504 4 x 10 mm



LOVE-GRUENWALD
BS-3303 3 x 10 mm



SPURLING
BS-3604 4 x 10 mm



Üst çene hareketli
Upper part of jaw movable

LOVE-GRUENWALD
BS-3403 3 x 10 mm



LOVE-GRUENWALD
BS-3704 4 x 10 mm

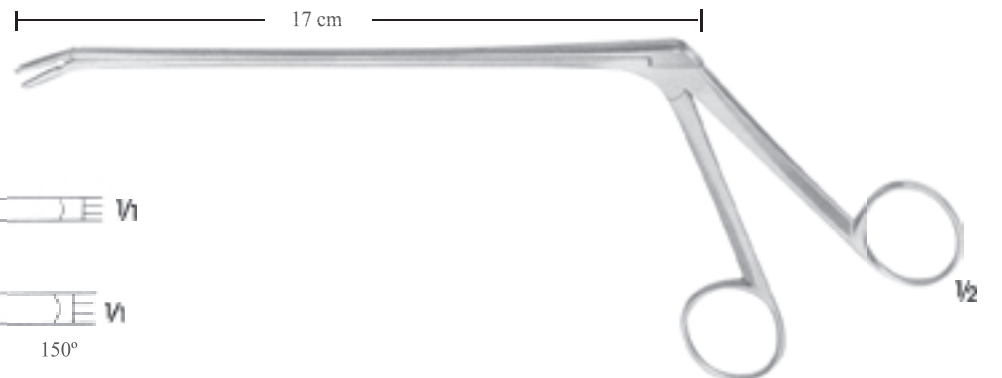



OLDBERG
BS-4727 Ø 7 mm



YASARGIL
BS-4732 Ø 2.2 mm

BS-4743 Ø 3.5 mm

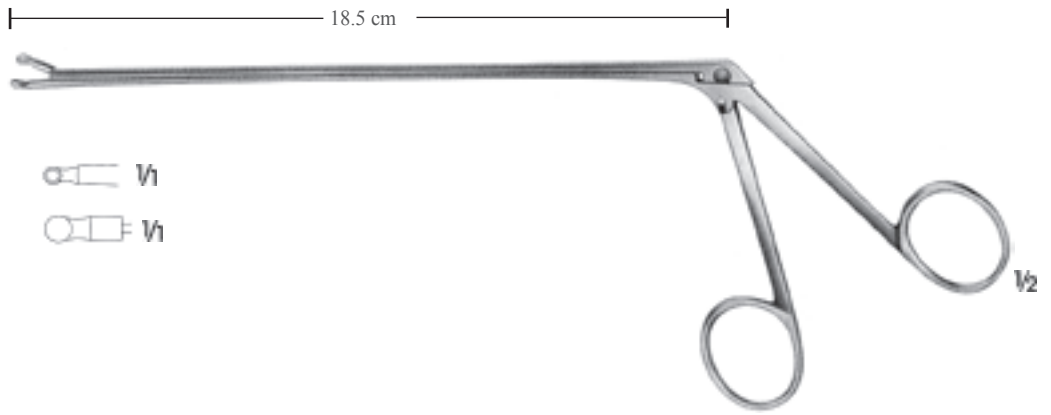

LANDOLT
BS-4749 Ø 9 mm
Grasping tümör penssi, künt
Tumor grasping forceps, blunt

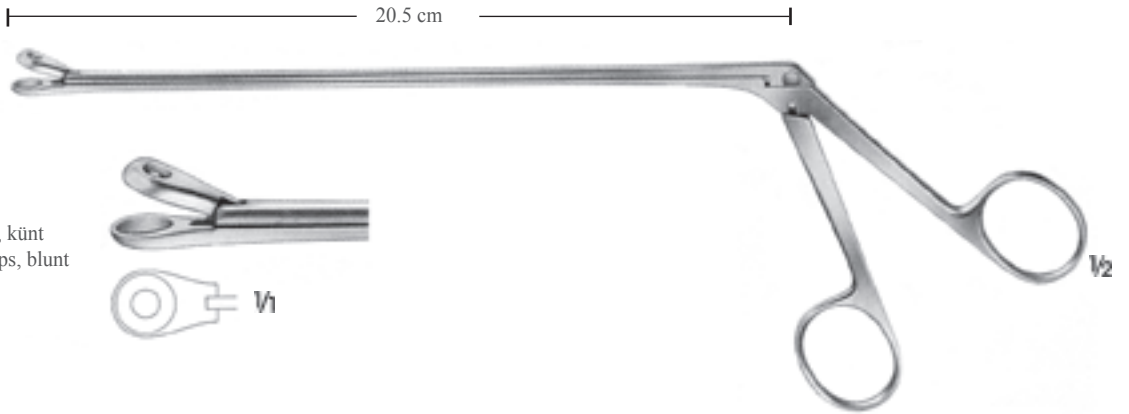

KRAMER
BS-4752 2.5 x 10 mm
Derinlik koruyuculu
With depth guard

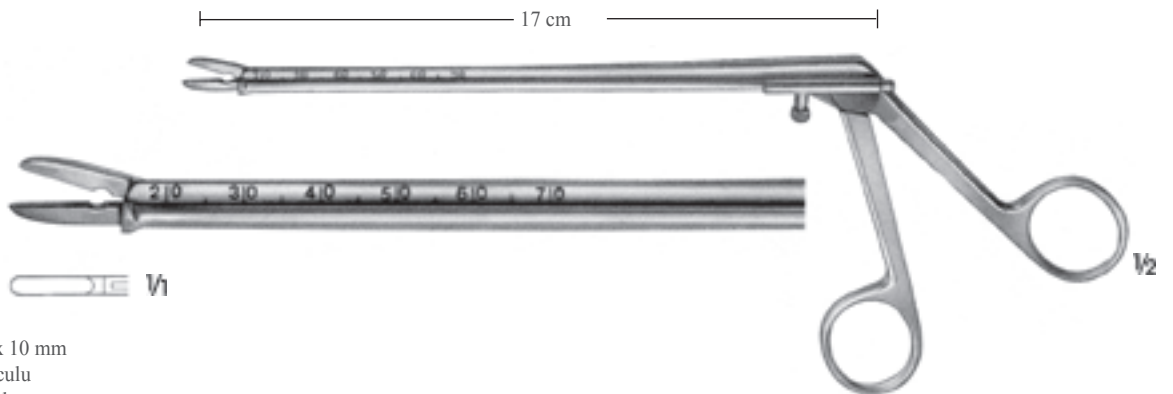

Alt çene hareketli
Upper part of jaw movable

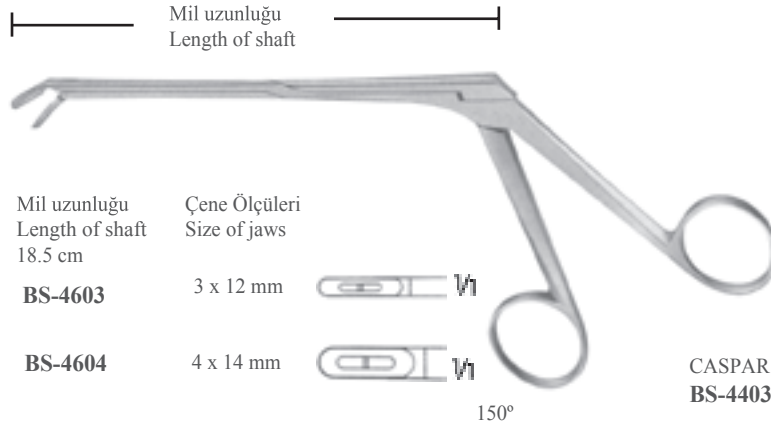

Mil uzunluğu
Length of shaft
14 cm

BS-4403

Mil uzunluğu
Length of shaft
16 cm

BS-4503

Mil uzunluğu
Length of shaft
18.5 cm

BS-4603

Çene Ölçüleri
Size of jaws
3 x 12 mm



1/1

BS-4404

BS-4504

BS-4604

4 x 14 mm



1/1

CASPAR
BS-4403 - BS-4604

150°

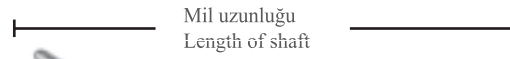

Mil uzunluğu
Length of shaft
14 cm

BS-3802

Mil uzunluğu
Length of shaft
16 cm

BS-3902

Mil uzunluğu
Length of shaft
18.5 cm

BS-4002

Çene ölçüleri
Size of jaws
2 x 12 mm



1/1

BS-3803

BS-3903

BS-4003

3 x 12 mm



1/1

BS-3804

BS-3904

BS-4004

4 x 14 mm



1/1

BS-3805

BS-3905

BS-4005

5 x 14 mm



1/1

BS-3806

BS-3906

BS-4006

6 x 16 mm



1/1

CASPAR
BS-3802 - BS-4006

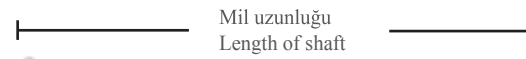

Mil uzunluğu
Length of shaft
16 cm

BS-4103

Mil uzunluğu
Length of shaft
16 cm

BS-4203

Mil uzunluğu
Length of shaft
18.5 cm

BS-4303

Çene ölçüleri
Size of jaws
3 x 12 mm



1/1

BS-4104

BS-4204

BS-4304

4 x 14 mm



1/1

BS-4105

BS-4205

BS-4305

5 x 14 mm



1/1

CASPAR
BS-4103 - BS-4305

150°



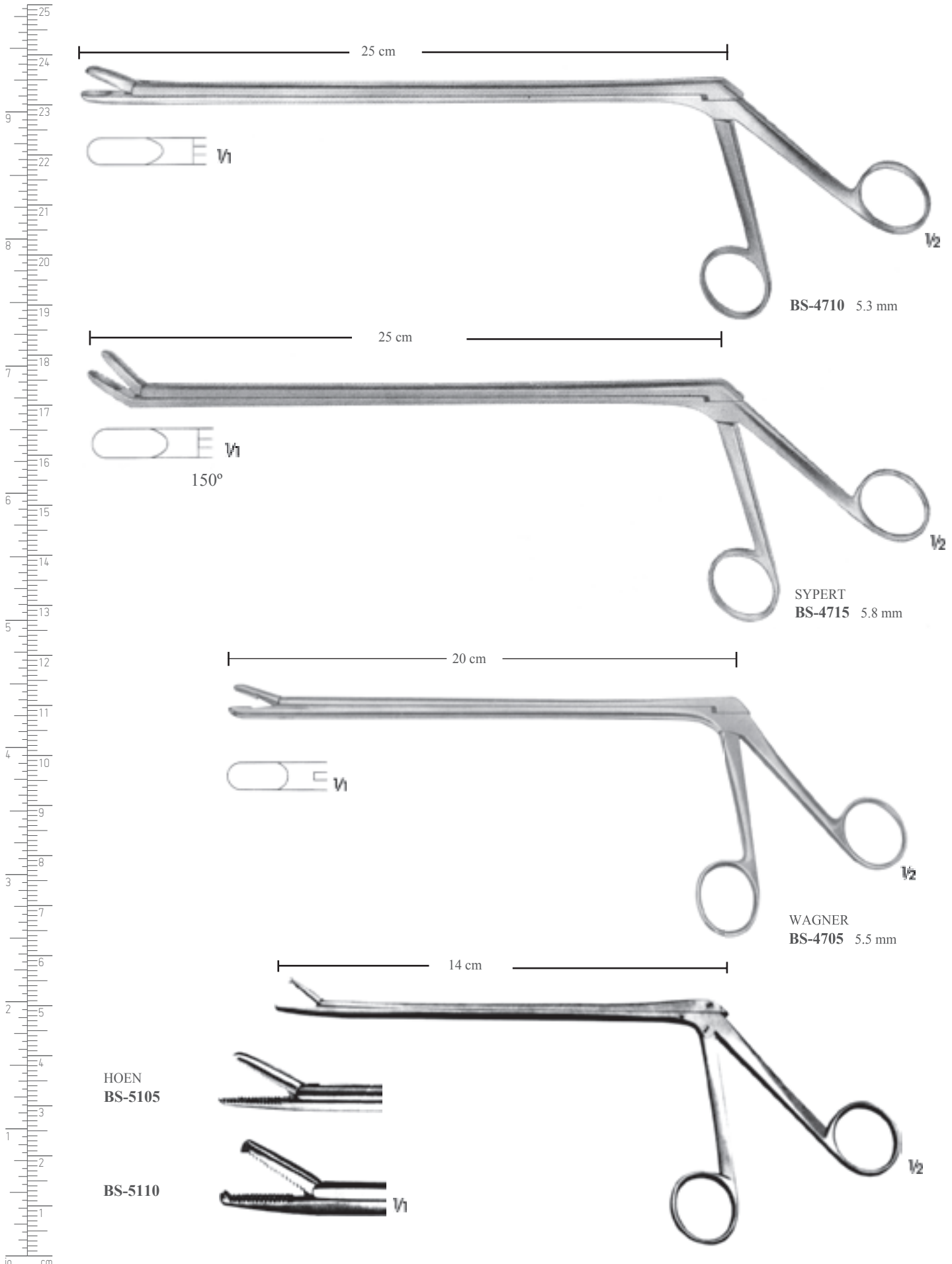



1 x 2 diş
1 x 2 teeth

KRAMER
BS-5115 15 cm
Bağ tutucu grasping pens, kilitli
With catch grasping forceps for
ligamentum flavum

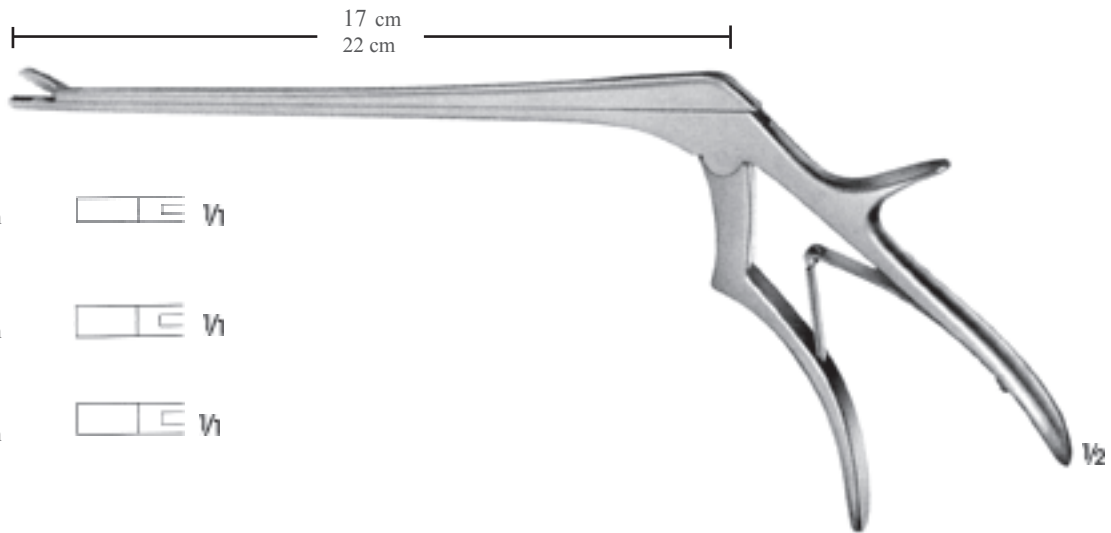

CASPAR
BS-5132 3 mm
18 cm

CASPAR
BS-5131 4 mm
18 cm

CASPAR
BS-5133 4 mm
20.5 cm

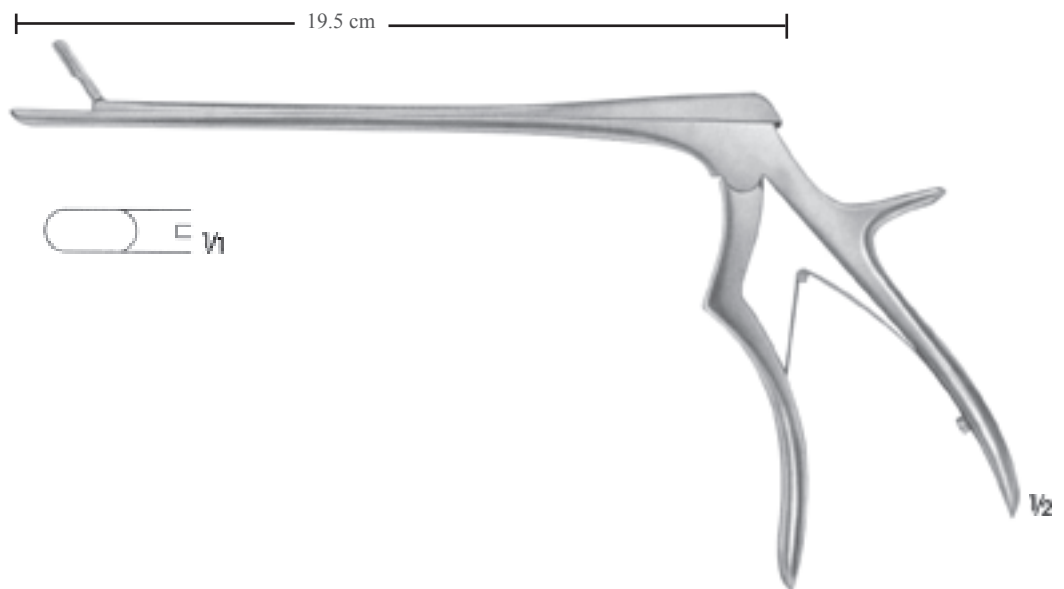

WAGNER
BS-5141 5.5 mm

NS

Beyin Cerrahi
Neurosurgery





CRUTCHFIELD
BT-1500
Çocuklar için/For children



CRUTCHFIELD
BT-1501
Orta boy/Medium size



GARDNER-WELLS
BT-1640
Maksimum açıklık (16 cm)
Maximum opening (16 cm)



BT-1503
Matkap ucu, büyük
Drill point, large
Ø 5 mm



BT-1502
Matkap ucu, küçük
Drill point, small
Ø 3.5 mm



BT-1631
Anahtar/wrench



BT-1630
Pimleri ayarlanabilir büyük boy
Traksiyon anahtarı ile BT-1631
Large size Traction tongs with
adjustable pins and spanner
BT-1631

BY-1130
Komple/Complete
(BY-1131 - BY-1220)

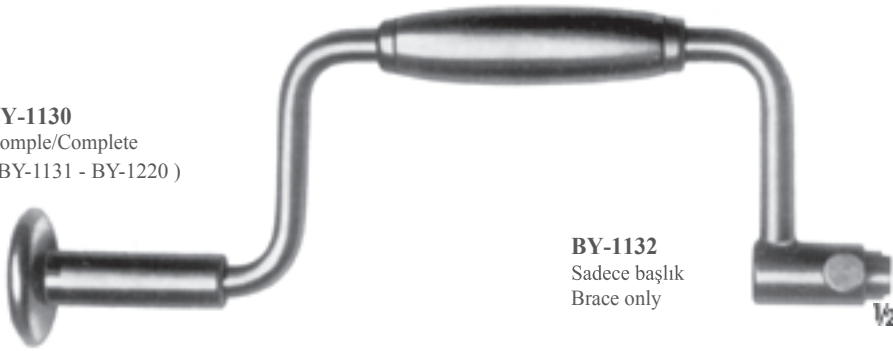

BY-1132
Sadece başlık
Brace only



BY-1131
Sadece uzatma parçası
Extension piece only

HUDSON DOWNS
BY-1332
Sadece Başlık
Brace only



HUDSON DOWNS
BY-1331
Uzatma parçası
Extension piece

HUDSON
BY-1337
El matkabı
Hand drill



HUDSON
BY-1336
Sadece uzatma parçası
Extension piece only



CUSHING
BY-1310
Ø 10 mm

CUSHING
BY-1315
Ø 15 mm

CUSHING
BY-1135
Ø 14 mm

McKENZIE
BY-1136
Ø 13 mm

HUDSON
BY-1214
Ø 14 mm

HUDSON
BY-1216
Ø 16 mm

ADSON
BY-1215
Ø 15 mm

HUDSON
BY-1222
Ø 22 mm

HUDSON
BY-1209
Ø 9 mm

BY-1220
Ø 2 mm



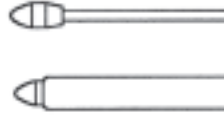

BV-3843 Ø 4 mm
43.5 cm
BV-3860 Ø 4 mm
60 cm

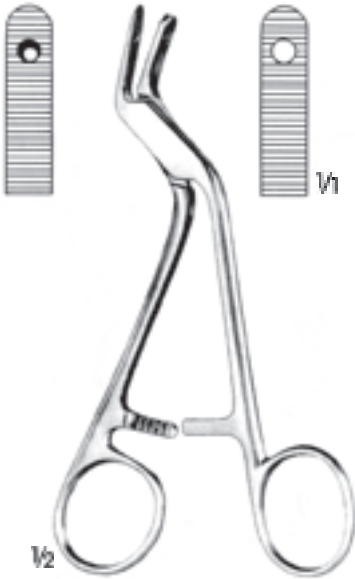

ADSON
BR-7900
15 cm



BR-7901
Koruma pensi
Protection forceps
20.5 cm



SWEET
BR-7890 20 cm
BR-7891 23 cm

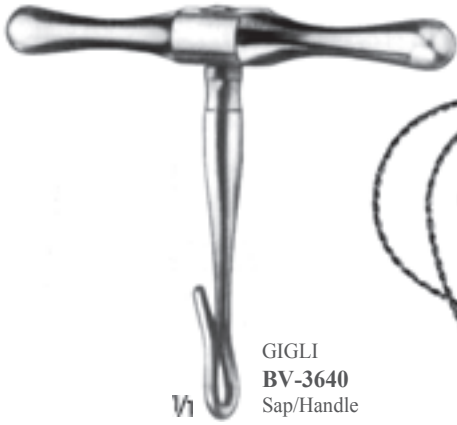

GIGLI
BV-3640
Sap/Handle

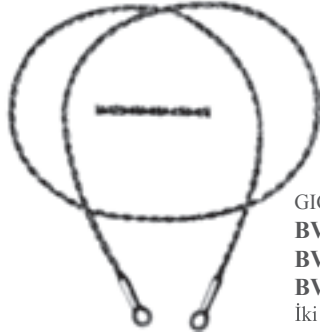

GIGLI
BV-3730 30 cm
BV-3740 40 cm
BV-3750 50 cm
İki sargılı/Two windings

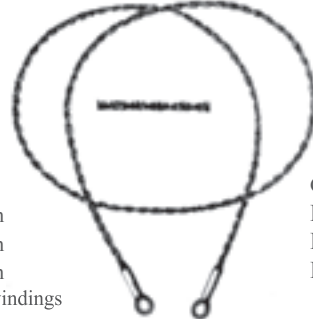

GIGLI
BV-3830 30 cm
BV-3840 40 cm
BV-3850 50 cm
Üç sargılı/Three winding



DE MARTEL
BV-3855 35 cm
Kondüktör için gigli testere teli, esnek
Gigli saw for the flexible conductor wire



DAHLGREN
BR-7896



DE VILBISS
BR-7897
1huk dahil/with 1 hook
20 cm



DAHLGREN
BR-7895
2 huk ile birlikte
With 2 extra hooks
21 cm





10 cm

HEIFETZ

- BK-7400** 8 mm
- BK-7401** 11 mm
- BK-7402** 14 mm
- BK-7403** 17 mm
- Bükülebilir/Malleable
15.5 cm

HEIFETZ

- BK-7504** 8 mm
- BK-7500** 11 mm
- BK-7501** 14 mm
- BK-7502** 17 mm
- BK-7503** 20 mm
- Bükülebilir/Malleable
20 cm

10 cm

- BK-6300** 7 + 8 mm
- BK-6301** 10 + 11 mm
- BK-6302** 13 + 14 mm
- BK-6303** 16 + 17 mm
- BK-6304** 19 + 20 mm
- BK-6305** 22 + 25 mm
- Bükülebilir/Malleable
20 cm

- BK-6400** 9 mm
- BK-6401** 12 mm
- 20 cm
- BK-6402** 12 mm
- 25 cm
- BK-6500** 13 X 19 mm
- BK-6501** 15 X 19 mm
- BK-6502** 19 X 25 mm
- 20 cm
- Bükülebilir/Malleable

- BK-6600** 12 mm
- BK-6601** 17 mm
- 20 cm
- BK-8852** 25 mm
- 25 cm
- Bükülebilir/Malleable

- BK-6800** 7 + 9 mm
- BK-6801** 11 + 13 mm
- BK-6802** 15 + 18 mm
- BK-6803** 18 + 22 mm
- Bükülebilir/Malleable
18 cm

OLIVECRONA

- BK-6900** 7 + 9 mm
- BK-6901** 11 + 13 mm
- BK-6902** 15 + 18 mm
- BK-6903** 18 + 22 mm
- Esneyebilir/Flexible
18 cm

1/2

1/2

Silikon Kaplı Beyin Kaşığı

Bükülebilir silikon kaplı elastik metal kaşık

Atraumatik açma

Tek kullanımlık

10'luk Paket

Silikone Coated Brain Spatula

Malleable metal spatula with elastic silicone coating

Atraumatic retraction

For single use

1 package of 10 pieces

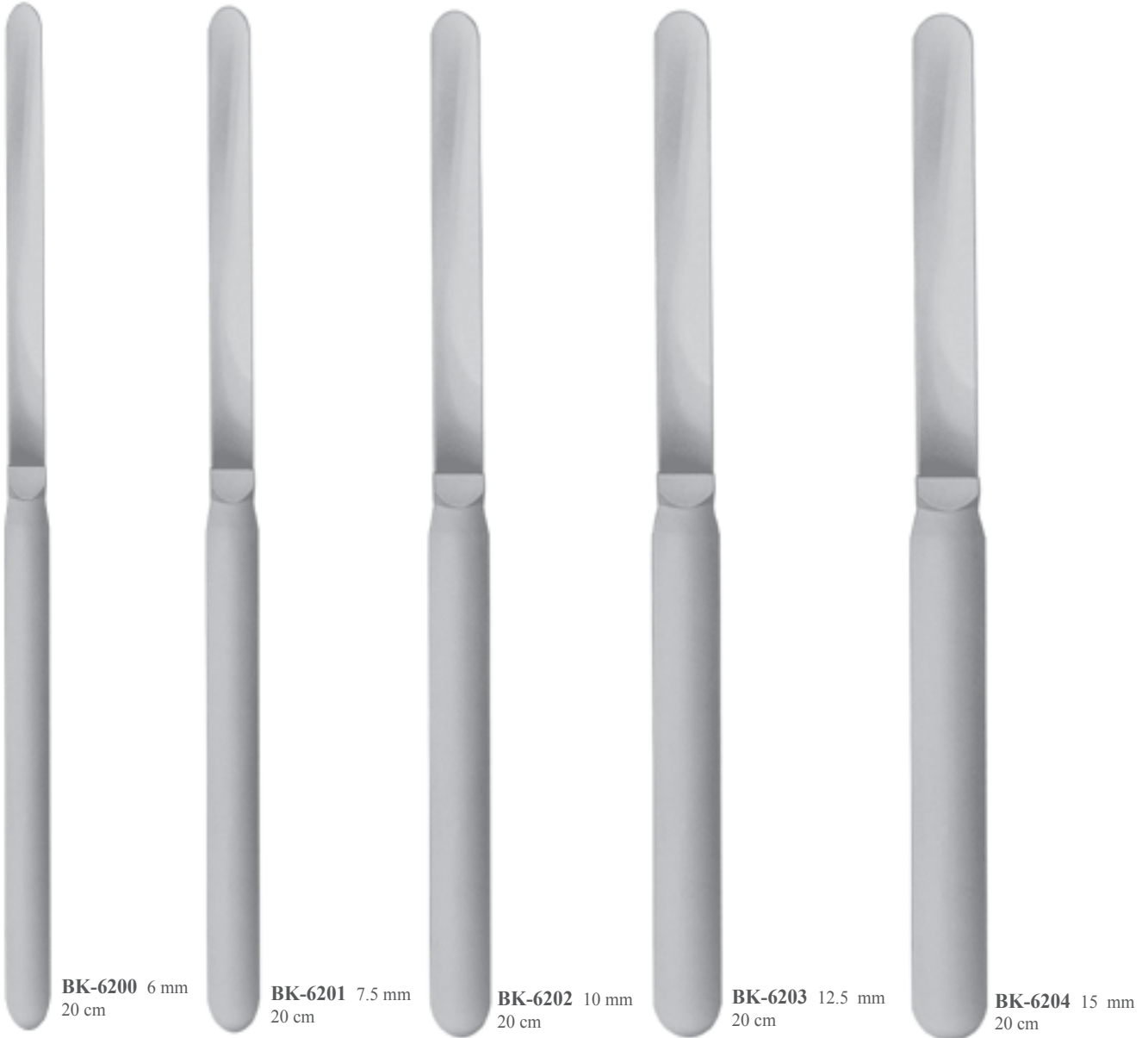



BG-1700 25°
15 cm
BG-1701 25°
20 cm
BG-1702 25°
28 cm



BG-1703 65°
20 cm
BG-1704 65°
28 cm



BG-1800 25°
15 cm
BG-1801 25°
20 cm
BG-1802 25°
28 cm



BG-1803 65°
20 cm
BG-1804 65°
28 cm



BG-1900 25°
20 cm
BG-1901 25°
28 cm



BG-1902 65°
20 cm
BG-1904 65°
28 cm



BG-1905 90°
20 cm
BG-1906 90°
28 cm



BG-2000 25°
20 cm
BG-2001 25°
28 cm



BG-2002 65°
20 cm
BG-2003 65°
28 cm



BG-2004 90°
20 cm
BG-2005 90°
28 cm



RANEY
BV-3870
16 cm



Mc KENZIE
BV-3915
15 cm

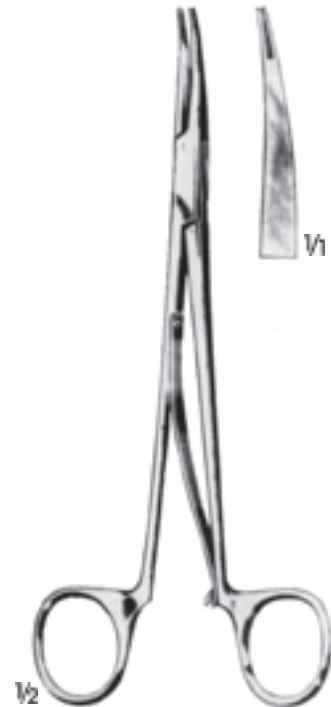

Mc KENZIE
BV-3919
19 cm

Galea tespitinde kullanılan Buldog klempı yaylı kanca, örtü bezine bağlanabilir.
Spring hook for galea fixation with Bulldog clamp, to be fastened to covering drape.

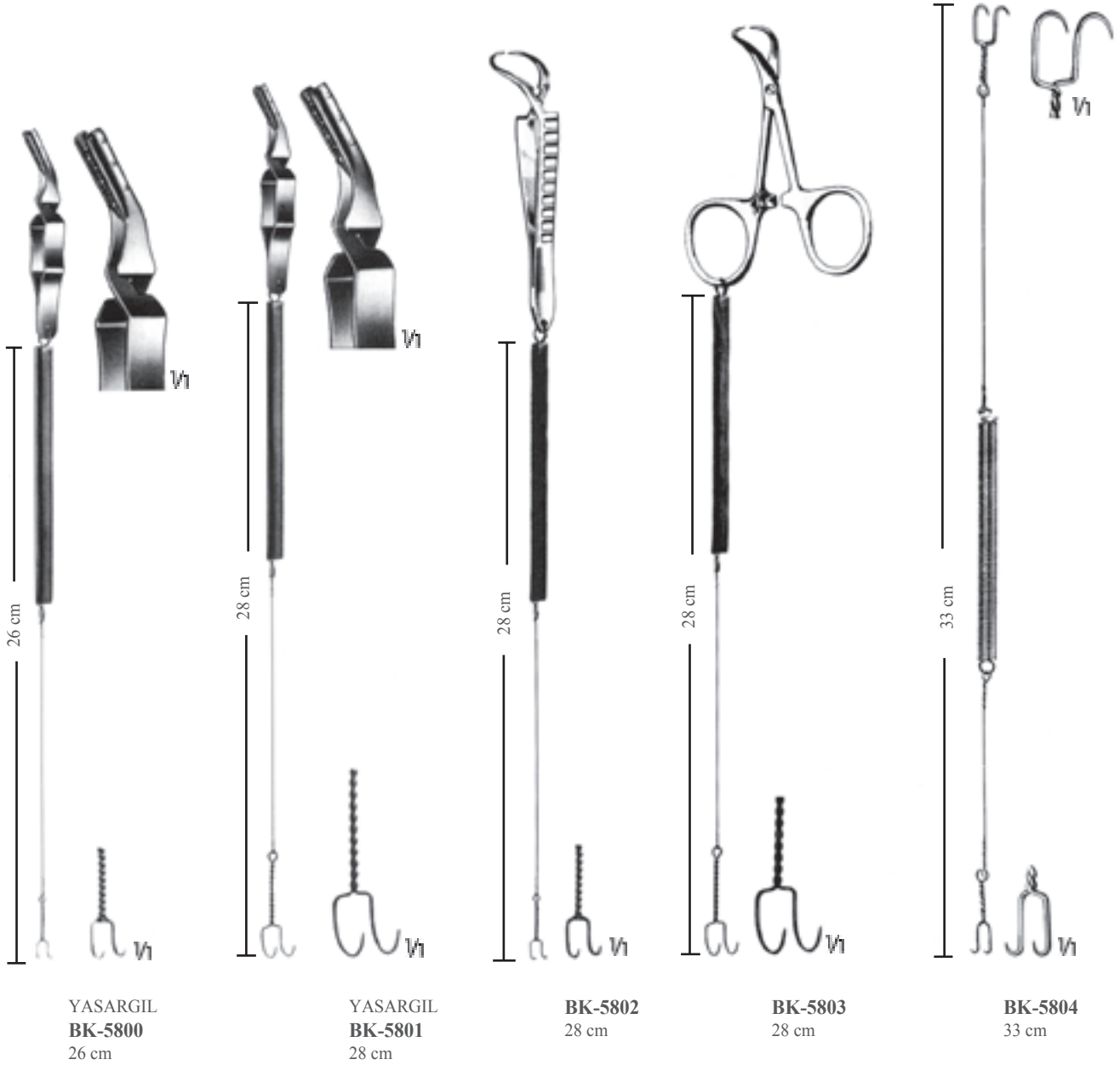



**HEIFETZ
BV-1705**
Damar açıcı
Vessel spreader
10 cm



**BIEMER
BV-1700 3 mm**
Damar açıcı
Vessel spreader
16 cm



BJ-2510
Ø 1.0 mm
12.5 cm

BJ-2515
Ø 1.5 mm
12.5 cm

BJ-2505 Ø 0.5 mm
12.5 cm



BJ-2540

BJ-2550

JACOBSON
BJ-2540 - BJ-2550
Sonda, küresel uçlu
Probe with ball tip
18.5 cm

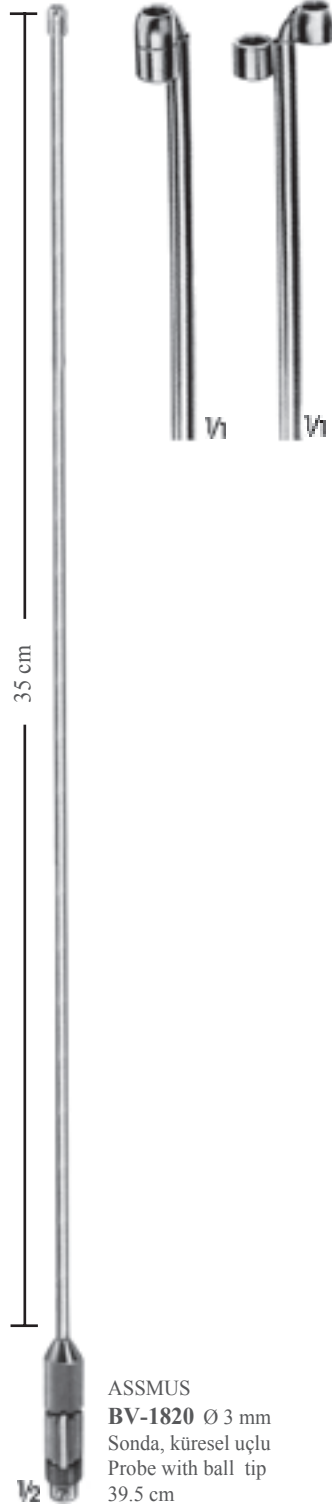

35 cm

ASSMUS
BV-1820 Ø 3 mm
Sonda, küresel uçlu
Probe with ball tip
39.5 cm



CASPAR
BV-1805
Ligatür ayarlayıcısı
Ligature adjuster
23 cm



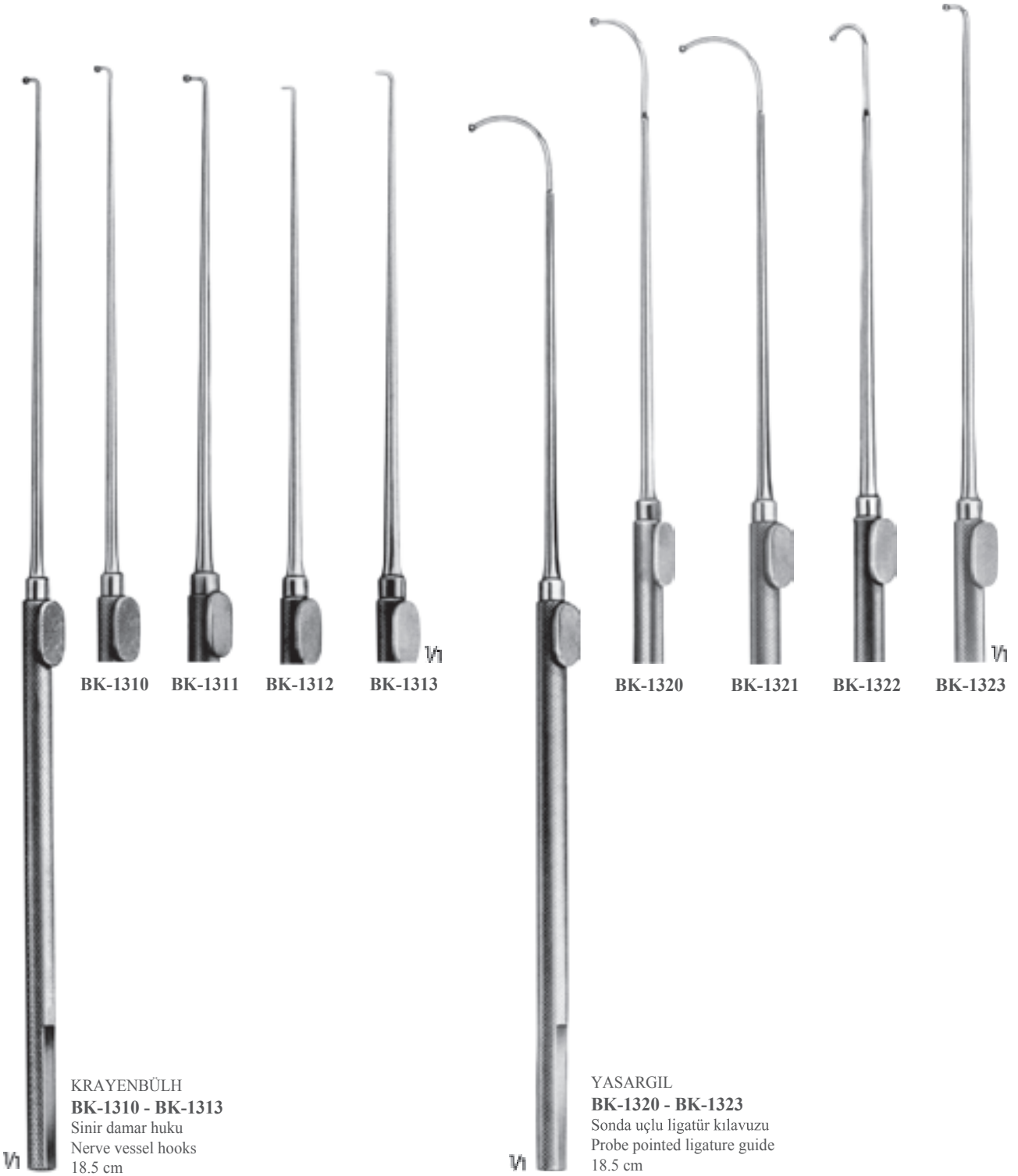

KRAYENBÜLH
BK-1310 - BK-1313
Sinir damar huku
Nerve vessel hooks
18.5 cm

YASARGIL
BK-1320 - BK-1323
Sonda uçlu ligatür kılavuzu
Probe pointed ligature guide
18.5 cm

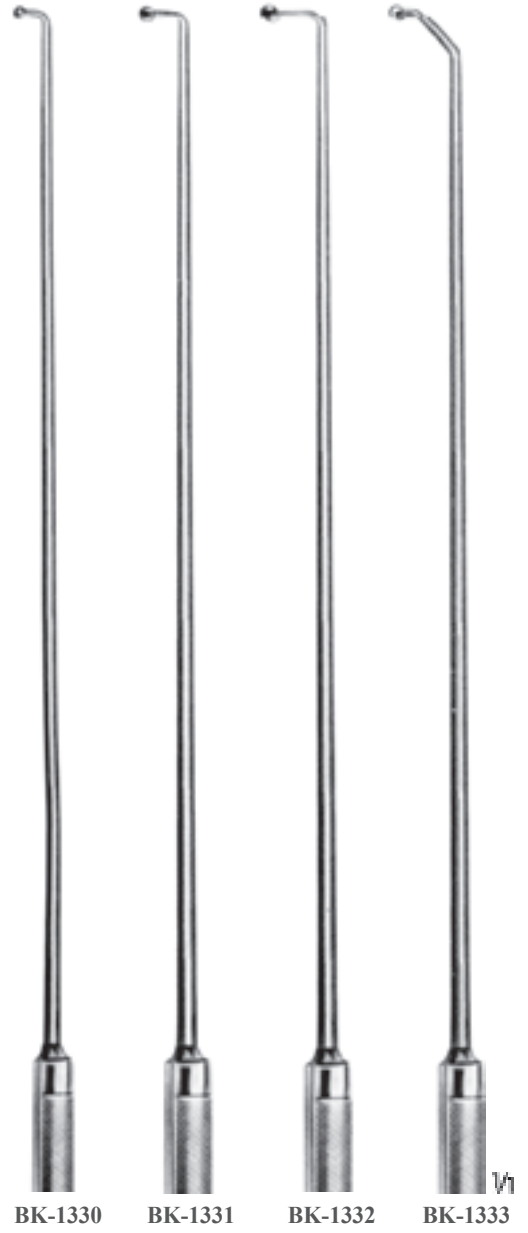



AA-2150
Ayna sapı
Mirror handle
10.5 cm



AA-2106
Laringel ayna
Laryngeal mirror
12 cm



AA-2006
Altıgen saplı Laringel
ayna
Laryngeal mirror with
Hexagonal handle
18 cm



YASARGIL
AA-2180 Ø 6 mm
Hareketli mikro ayna
Movable micro mirror
24 cm



AA-2170
Ayna/Mirror
26 cm



BN-1707 3 mm
Künt/Blunt
18.5 cm

BN-1708 3 mm
Künt/Blunt
21.5 cm

YASARGIL
BN-1709 4 mm
Çocuklar için, esnek
Flexible for children
19.5 cm

YASARGIL
BN-1710 7 mm
Yetişkinler için, esnek
Flexible for adults
19.5 cm

CASPAR
BN-1715
20 cm

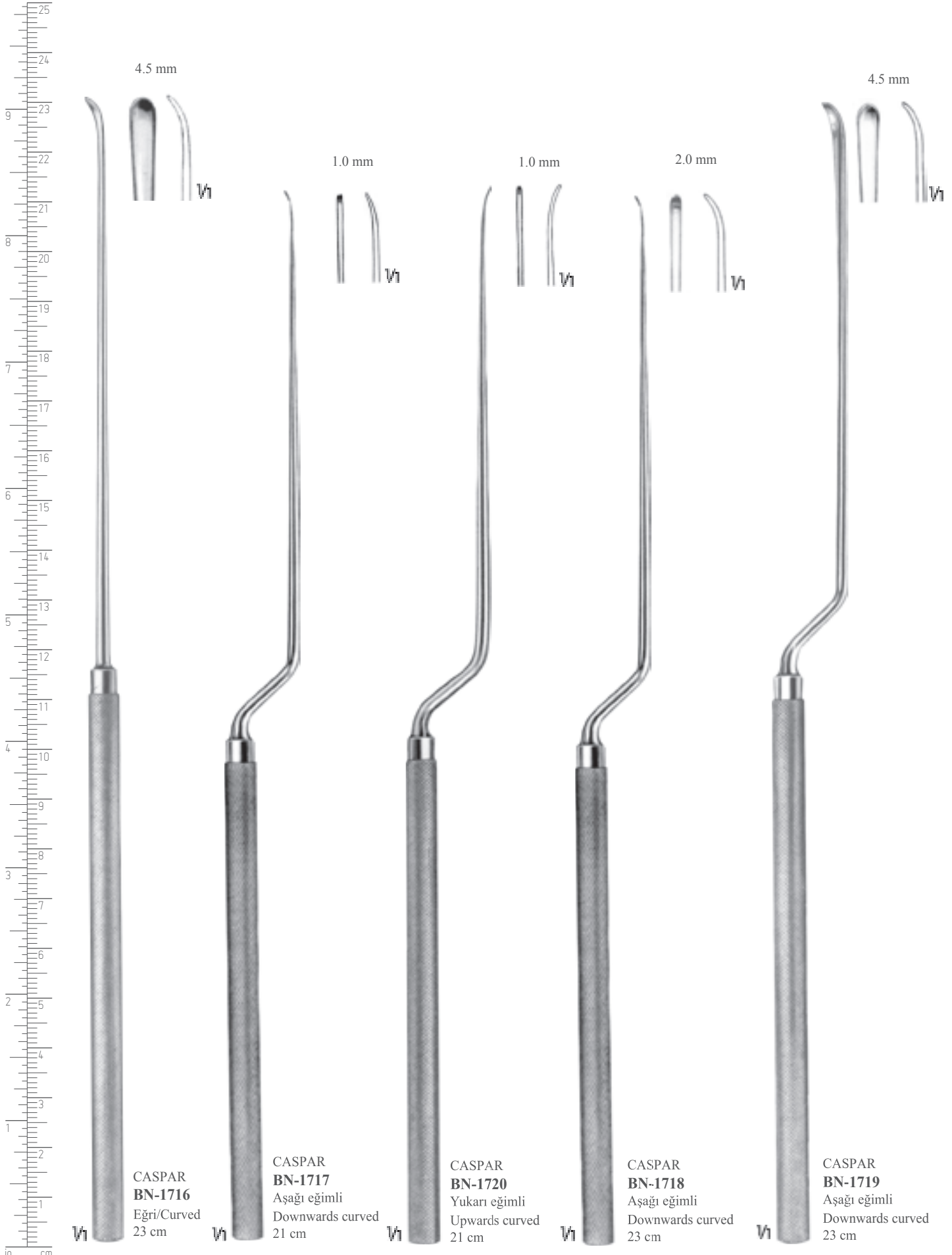

CASPAR
BN-1716
Eğri/Curved
23 cm

CASPAR
BN-1717
Aşağı eğimli
Downwards curved
21 cm

CASPAR
BN-1720
Yukarı eğimli
Upwards curved
21 cm

CASPAR
BN-1718
Aşağı eğimli
Downwards curved
23 cm

CASPAR
BN-1719
Aşağı eğimli
Downwards curved
23 cm

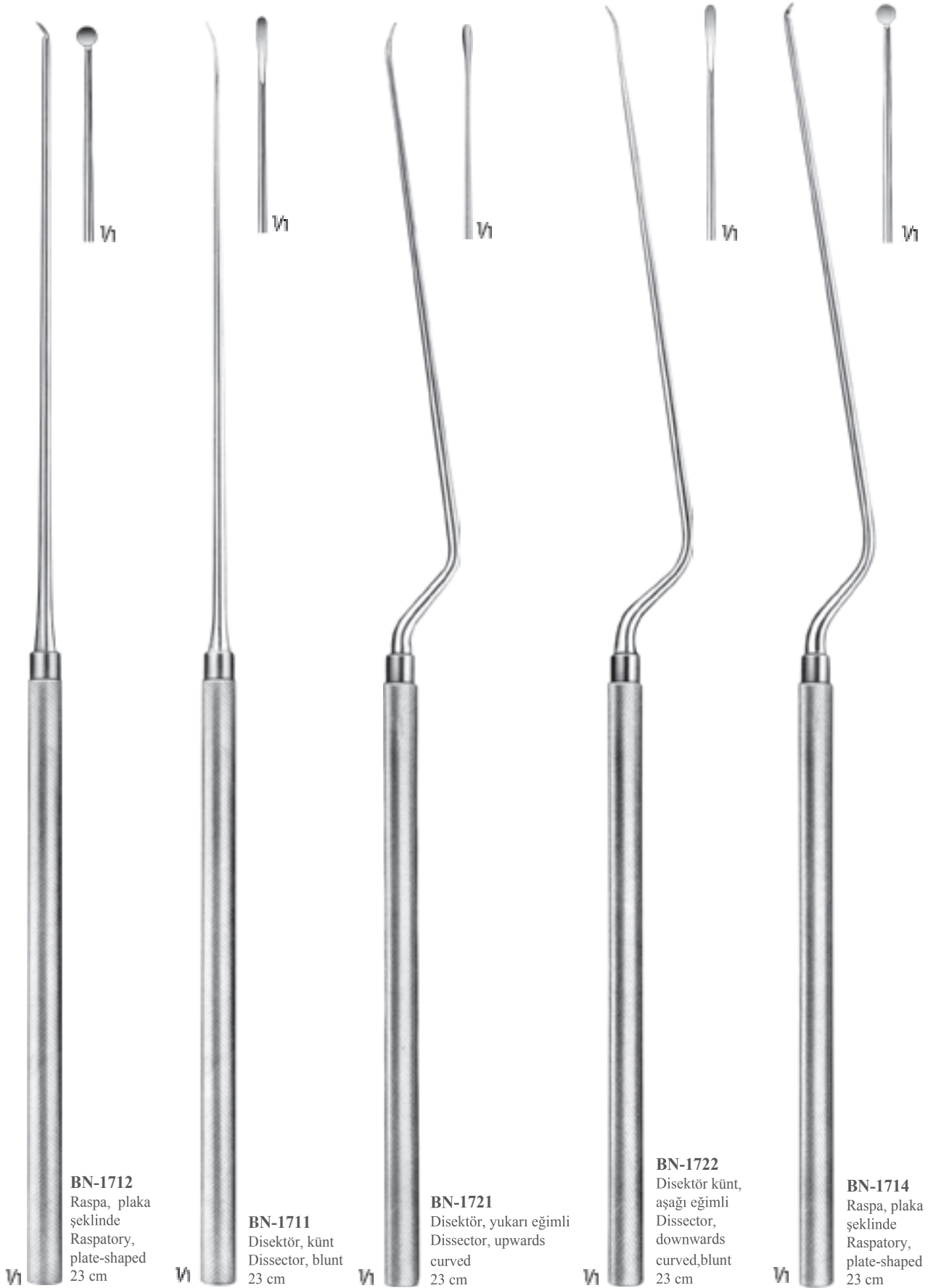



BK-1341
Mikro huk, künt
Micro hook, blunt
23 cm

BK-1340
Mikro huk/Sivri
Micro hook/Sharp
23 cm



BN-1725
Mikro disektör, düz
Micro dissector,
straight
23 cm



BN-1726
Mikro disektör, düz
Micro dissector,
straight
23 cm



BP-1600
Mikro kepçe düz,
keskin
Micro scoop,
straight, sharp
23 cm



BP-1601
Mikro kepçe açılı,
keskin
Micro scoop,
angled, sharp
23 cm



BN-1713
Mikro raspa,
yuvarlak bleyd
Micro raspatory,
round blade
23 cm





**YASARGIL
BN-1750**
Mikro raspa, açılı
Micro raspatory,
angled
18.5 cm



**YASARGIL
BN-1751**
Mikro disektör, açılı
Micro dissector,
angled
18.5 cm



**YASARGIL
BN-1752**
Mikro disektör, açılı
Micro dissector,
angled
18.5 cm



**YASARGIL
BN-1753**
Mikro raspa, hafif
kavisli
Micro raspatory,
slightly curved
18.5 cm



**YASARGIL
BN-1754**
Mikro raspa, eğri
Micro raspatory,
curved
18.5 cm



**YASARGIL
BN-1800**
Mikro raspa, aşağı eğimli
Micro raspatory, down-
wards curved
18.5 cm

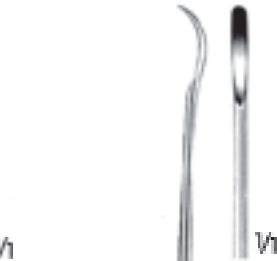

**YASARGIL
BN-1801**
Mikro raspa, aşağı eğimli
Micro raspatory, down-
wards curved
18.5 cm



**YASARGIL
BN-1802**
Mikro raspa, yukarı eğimli
Micro raspatory, up-
wards curved
18.5 cm



**YASARGIL
BP-1602**
Mikro kaşık küret
Micro scoop
18.5 cm





**JACOBSON
BB-1340**
Damar bıçağı
Vessel knife
18.5 cm



BB-1320 - BB-1335
18.5 cm



KOOS
BB-1320
Yukarı eğimli
Curved upwards



KOOS
BB-1321
Aşağı eğimli
Curved downwards



KOOS
BB-1322
Yukarı eğimli
Curved upwards



KOOS
BB-1323
Aşağı eğimli
Curved downwards



KOOS
BB-1324
Aşağı eğimli
Curved downwards



KOOS
BB-1325
Yukarı eğimli
Curved upwards



YAŞARGIL
BB-1330
Aşağı eğimli
Curved downwards



YAŞARGIL
BB-1335
Yukarı eğimli
Curved upwards



SAMII
BB-1410 - BB-1450
20 cm
BB-1510 - BB-1550
23 cm



SAMII
BB-1615 - BB-1660
Tümör dokusu için bıçaklar
Knives for tumor tissue
23 cm

BB-1615
Ø 1.5 mm

BB-1630
Ø 3.0 mm

BB-1645
Ø 4.5 mm

BB-1660
Ø 6.0 mm



SAMII
BB-1718 - BB-1725
Tümör dokusu için bistüri
bıçakları
Lancet knives for tumor tissue
23 cm

BB-1718
1.8 mm

BB-1725
2.5 mm



CASPAR
BB-1801
Mikro bıçak, künt
Micro knife, blunt
20 cm



CASPAR
BB-1802
Mikro bıçak, künt
Micro knife, blunt
20 cm



Bleyd No.3
Blade No.3



BB-1105
Bistüri sapı
Scalpel handle
21 cm





YASARGIL
BV-4030 Mini/Mini
BV-4031 Standart/Standard
17,5 cm



YASARGIL
BV-4032 Mini/Mini
BV-4033 Standart/Standard
17,5 cm

Mini Standart
Mini Standard

BV-4034 **BV-4035**



Düz/Straight

BV-4038 **BV-4039**



15° Açılı/15° Angled

BV-4042 **BV-4043**



30° Açılı/30° Angled



YASARGIL
BV-4034 - BV-4035
BV-4038 - BV-4039
BV-4042 - BV-4043
21.5 cm

BV-4036 **BV-4037**



Düz/Straight

BV-4040 **BV-4041**



15° Açılı/15° Angled

BV-4044 **BV-4045**



30° Açılı/30° Angled

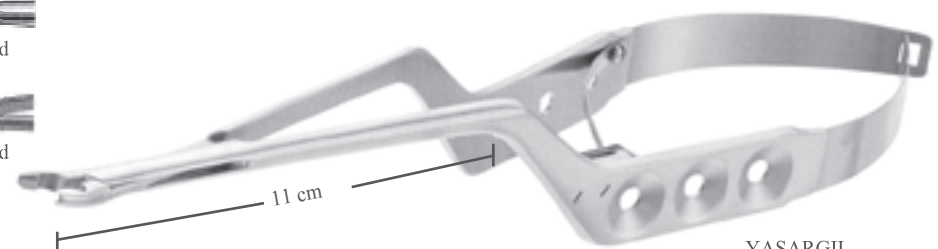

YASARGIL
BV-4036 - BV-4037
BV-4040 - BV-4041
BV-4044 - BV-4045
23.5 cm



BV-4015
Hizalama anahtarı
Alignment key



BV-4013 Mini/Mini
BV-4014 Standart/Standard
21.5 cm

Düz 15° Açılı 30 Açılı
Straight 15° Angled 30° Angled



BV-2601 Mini/Mini BV-2608 Standart Standard 22 cm	BV-2603 Mini/Mini BV-2610 Standart Standard 22 cm	BV-2605 Mini/Mini BV-2612 Standart Standard 22 cm
--	--	--

Düz 15° Açılı 30 Açılı
Straight 15° Angled 30° Angled



BV-2602 Mini/Mini BV-2609 Standart Standard 25 cm	BV-2604 Mini/Mini BV-2611 Standart Standard 25 cm	BV-2606 Mini/Mini BV-2613 Standart Standard 25 cm
--	--	--

Mini/Mini Standart/Standard

BV-2535 **BV-2550**

BV-2540 **BV-2555**

BV-2545 **BV-2560**

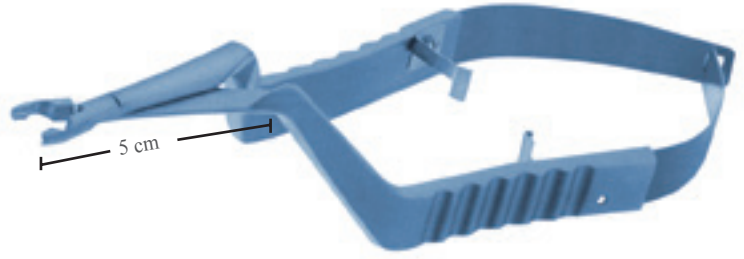

YASARGIL
BV-2600 Mini/Mini
BV-2607 Standart/Standard
18 cm

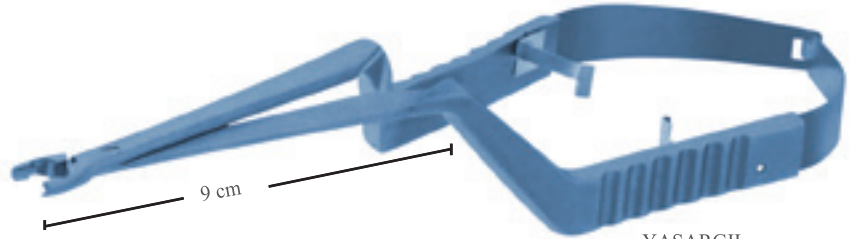

YASARGIL
BV-2601 - BV-2608
BV-2603 - BV-2610
BV-2605 - BV-2612

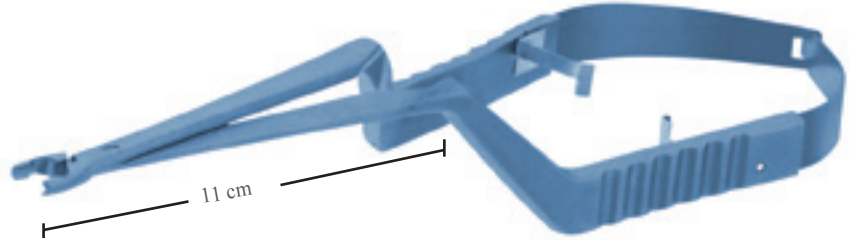

YASARGIL
BV-2602 - BV-2609
BV-2604 - BV-2611
BV-2606 - BV-2613





**YASARGIL
BT-1700**
Tek kollu komple otomatik beyin ekartörü
Self-retaining brain retractor, with 1 flexible
arm, complete, consisting of:
BT-1709 Tespit elemanı/Fixation base
BT-1703 Yalnız esnek kol/Flexible arm only
BT-1711 Kaşık tutucu/Support for spatula

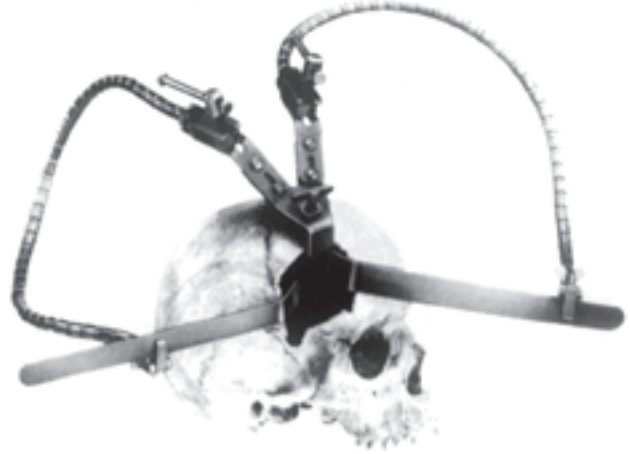

**YASARGIL
BT-1701**
İki kollu komple otomatik beyin ekartörü
Self-retaining brain retractor, with 1 flexible
arm, complete, consisting of:
BT-1710 Tespit elemanı (1 adet)/Fixation base (1 each)
BT-1703 Yalnız esnek kol (2 adet)/Flexible arm only (2 each)
BT-1711 Kaşık tutucu (2 adet)/Support for spatula (2 each)



BT-1708
Tespit elemanı
Fixation base



**YASARGIL
BT-1703**
Yalnız esnek kol
Flexible arm only



BT-1709
Tespit elemanı
Fixation base



BT-1711
Kaşık tutucu/Support only



BT-1712
Kaşık tutucu/Support only



BT-1710
Tespit elemanı
Fixation base



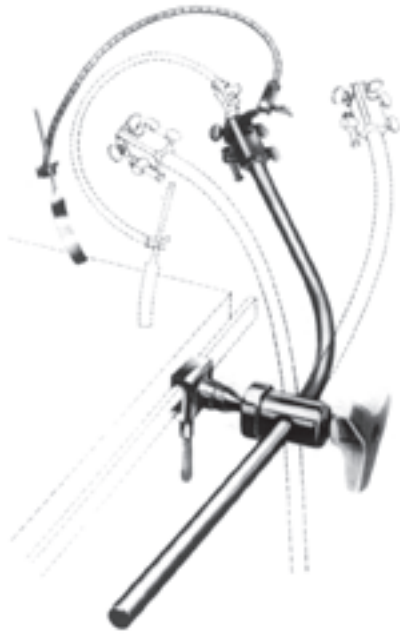

BT-1713

BT-1717 Masa bağlantı mafsalı/Ball-and socket joint
BT-1720 Tutucu mil/Holding rod
BT-1716 Bağlantı başlığı/Coupling head
BT-1703 Yalnız esnek kol/Flexible arm only
BT-1712 Kaşık tutucu/Support for spatula

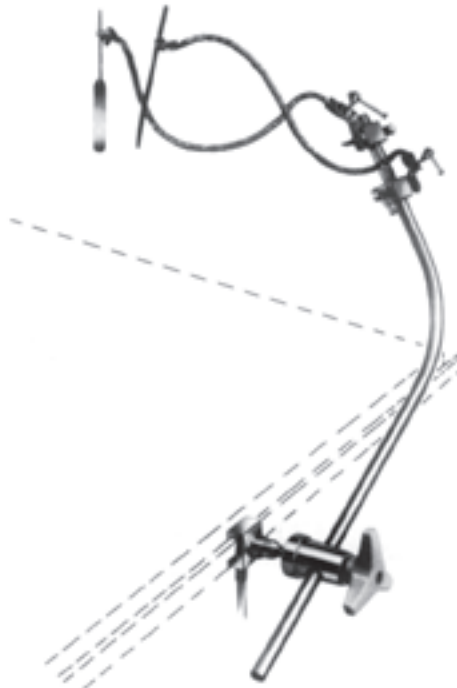

BT-1714

BT-1717 Masa bağlantı mafsalı/Ball-and socket joint
BT-1720 Tutucu mil/Holding rod
BT-1719 2 adet bağlantı başlığı/Coupling head (2 each)
BT-1703 2 adet yalnız esnek kol/Flexible arm only (2 each)
BT-1711 Kaşık tutucu/Support for spatula
BT-1712 Kaşık tutucu/Support for spatula



BT-1716
Bağlantı başlığı
Coupling head



BT-1715

Masa bağlantı mafsalı
Joint for table fixation
maximum 9 x 32 mm

BT-1717

Masa bağlantı mafsalı
Joint for table fixation
10 x 25 mm



BT-1718

Döner bağlantı başlığı
Turnable coupling head

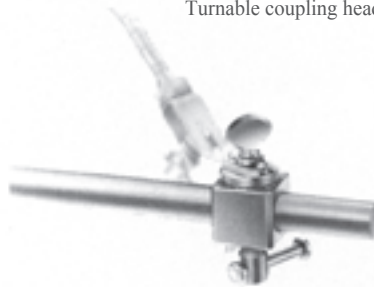

BT-1719

Döner bağlantı başlığı
Turnable coupling head

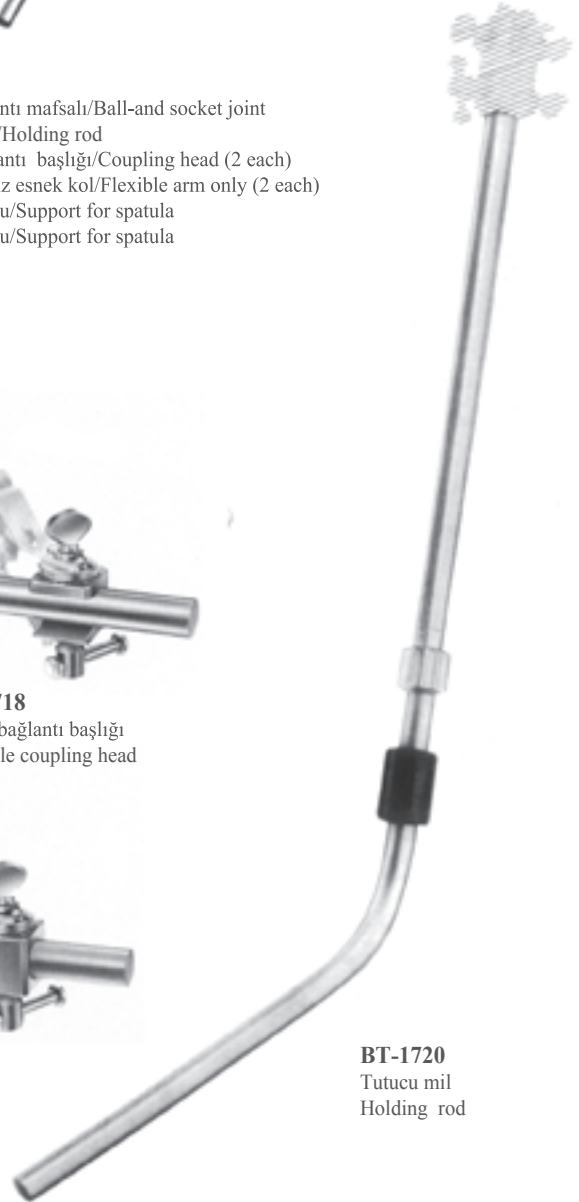

BT-1720

Tutucu mil
Holding rod





BT-1733



BT-1732

BT-1731

GILSBACH

BT-1725 (Komple/Complete)
Temel ünite/Basic unit

BT-1731 Tutucu mil/Holding rod

BT-1732 Esnek kollar için yarım daire bar/Semi-circular basic bar, for flexible arms

BT-1733 Galea hukları için çerçeve/Frame for Galea hook

GILSBACH EKARTÖR SETİ/GILSBACH RETRACTOR SYSTEM

BT-1730 (Komple/Complete)

BK-5805 4 Adet/4 Each

BT-1705 2 Adet/2 Each

BT-1711 1 Adet/1 Each

BT-1712 1 Adet/1 Each

BT-1723 1 Adet/1 Each

BT-1725 1 Adet/1 Each

BT-1726 1 Adet/1 Each

BT-1736 1 Adet/1 Each

BT-1721 1 Adet/1 Each

BT-1722 1 Adet/1 Each

CN-6022 1 Adet/1 Each

CN-2461 1 Adet/1 Each

CN-2462 1 Adet/1 Each



BT-1726 Masa bağlantı elemanı/Table Fixation attachment



BT-1736 Komple/Complete

BT-1727 Masa bağlantı elemanı/Table Fixation attachment(1 adet)

BT-1728 Masa bağlantı elemanı/Table Fixation attachment (1 pcs)

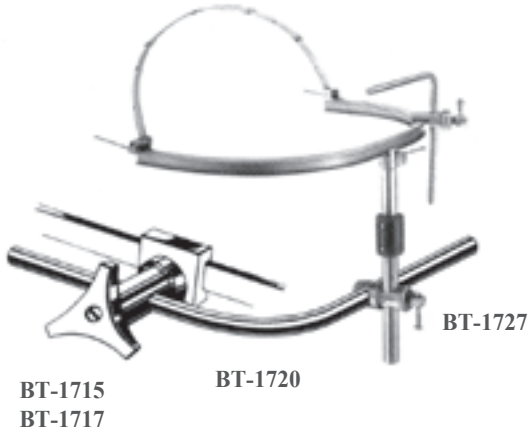

BT-1715
BT-1717

BT-1720

BT-1727

BT-1727 Masa bağlantı elemanı/Table Fixation attachment

BT-1720 Tutucu mil/Holding rod

BT-1715 Masa bağlantı mafsalı/Joint for table fixation
9 x 32 mm

BT-1717 Masa bağlantı mafsalı/Joint for table fixation
10 x 25 mm



BT-1722
Pens tutucu
Holder for forceps



GILSBACH
BT-1721
El dayama barı
Handrest bar





BT-1704 15 cm
BT-1705 20 cm
BT-1706 25 cm
Esnek kol/Flexible arm

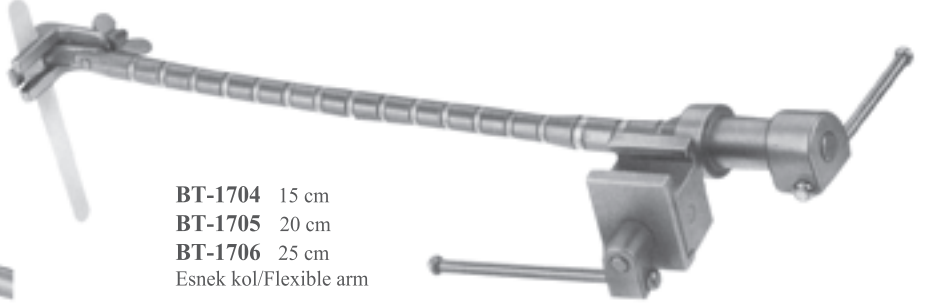

BT-1702
Esnek kol/Flexible arm



BT-1711
Kaşık tutucu
Support only



BT-1712
Kaşık tutucu
Support only

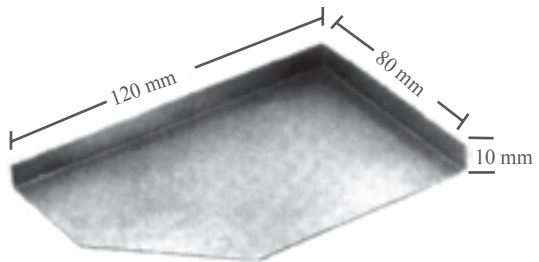

BT-1723
BT-1703 ve BT-1711 ile
sabitlenebilir tabla.
Tray can be to the BT-1703
and BT-1711

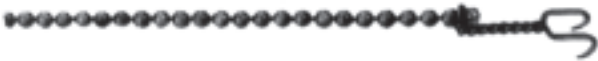

BK-5805
Zincirli huk (BT-1733 ile kullanılır)
Chain hook (Used to BT-1733)



BK-5810
Yaylı huk (BT-1733 ile kullanılır)
Spring hook (Used to BT-1733)

*Caspar Servikal Distraktör Sistemi için web sitemizi ziyaret ediniz.
Please visit our website for Caspar Servical Distractor System*

www.aseltech.com.tr

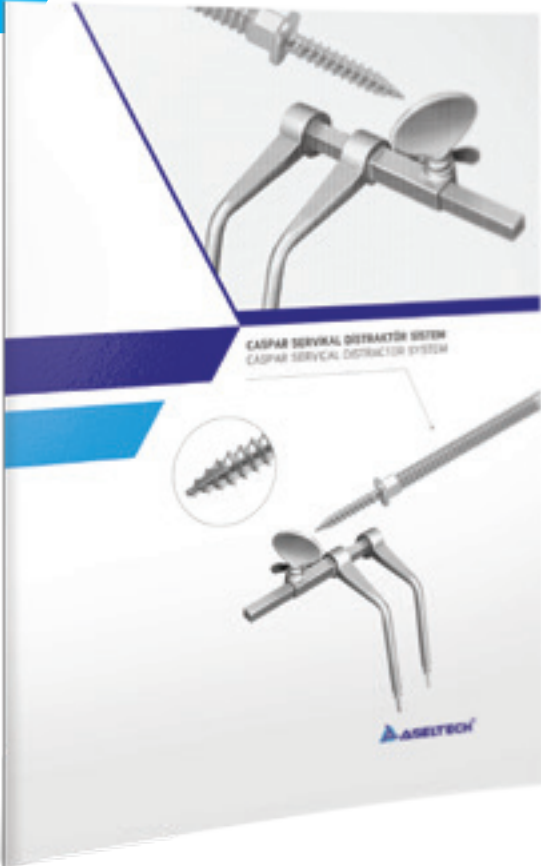



MAYFIELD
BT-1741
Kafa klempi/Skull clamp



GARDNER
BT-1750 10 mm
Yetişkinler için
Adult size
25 mm



MAYFIELD
BT-1745
Yetişkinler için
Adult size



MAYFIELD
BT-1746
Çocuklar için
Child size



GARDNER
BT-1751 6 mm
Çocuklar için
Child size
38 mm



MT.SINAI
BT-1752 10 mm
Çocuklar için
Child size
38 mm

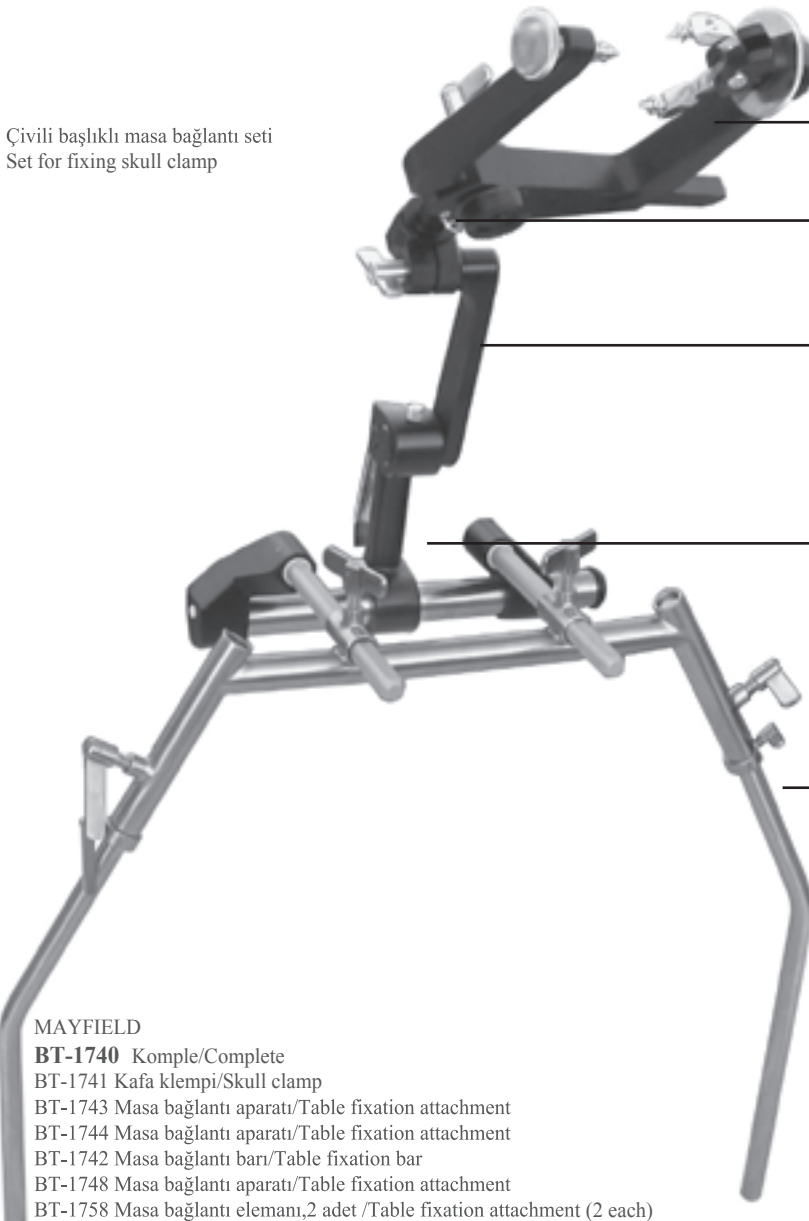

Çivili başlıklı masa bağlantı seti
Set for fixing skull clamp

MAYFIELD
BT-1741
Kafa klempi/Skull clamp

MAYFIELD
BT-1748
Masa bağlantı aparatı
Table fixation attachment

MAYFIELD
BT-1744
Masa bağlantı aparatı
Table fixation attachment

MAYFIELD
BT-1743
Masa bağlantı aparatı
Table fixation attachment

MAYFIELD
BT-1742
Masa bağlantı aparatı
Table fixation attachment

MAYFIELD
BT-1740 Komple/Complete
BT-1741 Kafa klempi/Skull clamp
BT-1743 Masa bağlantı aparatı/Table fixation attachment
BT-1744 Masa bağlantı aparatı/Table fixation attachment
BT-1742 Masa bağlantı barı/Table fixation bar
BT-1748 Masa bağlantı aparatı/Table fixation attachment
BT-1758 Masa bağlantı elemanı,2 adet /Table fixation attachment (2 each)



MAYFIELD
BT-1758
Masa bağlantı aparatı
Table fixation attachment

BT-1760 Komple/Complete

BT-1770 1 adet/1 each
BT-1775 1 adet/1 each
BT-1788 1 adet/1 each
Pediatrik kafa dayanağı uzatma çubuğu ile
Headrest pediatric with extension bar

BT-1765 Komple/Complete

BT-1780 1 adet/1 each
BT-1785 1 adet/1 each
BT-1790 1 adet/1 each
Yetişkinler için kafa dayanağı uzatma çubuğu ile
Adults with headrest extension bar

BT-1795

Jel kulak halkası 90 mm
Gel ear ring base 90 mm

BT-1797

Jel kulak halkası 90 mm
Gel ear ring base 90 mm

BT-1798

Jel baş halkası 140 mm
Gel head ring base 140 mm

BT-1788

Uzatma çubuğu
Extension bar

BT-1770

Kafa dayanağı, sağ
Headrest title, right

BT-1775

Kafa dayanağı, sol
Headrest title, left

BT-1790

Uzatma çubuğu
Extension bar

BT-1780

Kafa dayanağı, sağ
Headrest title, right

BT-1785

At balı başlık, sol
Horseshoe title, left

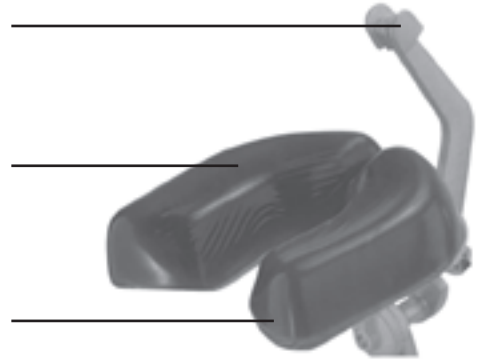

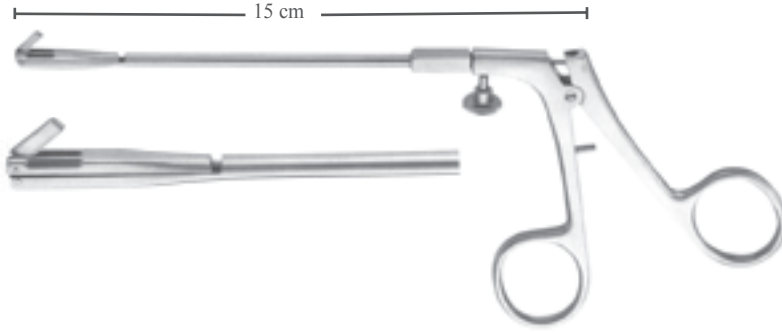

BR-7700
Antrum panç
Antrum punch



BY-2161
Anahtar/Key
15 cm



PAPAVERO-CASPAR
BM-1610 80 x 11 mm
BM-1611 90 x 13 mm
BM-1613 100 x 15 mm

HARDBLACK



BM-1612 90 x 13 mm
Transssfenoidal spekulum
Transssphenoidal specula

BY-2161 ile beraber
With key BY-2161
İnce profil, hafif transsfenoidal spekulum
Slim profile and lightweight specula for
transssphenoidal



PAPAVERO-HARTMANN
BM-1515
BM-1610, BM-1611, BM-1613 ile birlikte
Use with BM-1610, BM-1611, BM-1613



V1
34 x 9 mm



COTTLE
BM-1550 - BM-1551
Burun spekulumu/Nasal speculum
BM-1610, BM-1611, BM-1613 ile birlikte
Use with BM-1610, BM-1611, BM-1613
13.5 cm

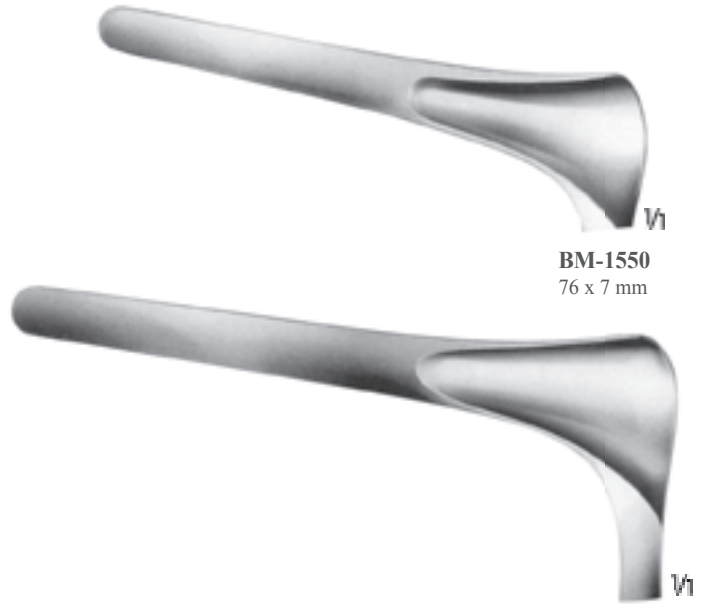

V1
BM-1550
76 x 7 mm

V1
BM-1551
90 x 7 mm



CUSHING-LANDOLT
BM-1600 70 x 15 mm
BM-1601 90 x 15 mm
BM-1602 110 x 15 mm
Transsfenoidal, hipofizektomi spekulum
Specula for transsphenoidal hypophysectomy



JANSEN-MIDDLETON
BR-7910
20 cm



COTTLE
BN-6404 4 mm
BN-6407 7 mm
BN-6409 9 mm
BN-6412 12 mm
Derinlik işaretli çizil
Chisel with depth markings
18 cm



PAPAVERO
BN-5244 4 mm
Bayonet çizil
Bayonet chisel, 4 mm
22 cm



LANDOLT
BM-1605
Spekulum için ayırıcı
Spreader for specula
BM-1600 - BM-1602
21 cm



COTTLE
BN-9810 240 gr
Çekiç, bir tarafı düz
bir tarafı dış bükey
Mallet, 1 side flat, 1
side convex
18.5 cm





HARDY
BN-2000 - BN-2007
24.5 cm

BN-2000 Sağ, künt Right, blunt	BN-2002 Sol, künt Left, blunt	BN-2001 Sağ, künt Right, blunt	BN-2003 Sol, künt Left, blunt	BN-2004 Sağ, sivri Right, sharp	BN-2006 Sol, sivri Left, blunt	BN-2005 Sağ, sivri Right, sharp	BN-2007 Sol, sivri Left, blunt



W1

LANDOLT
BN-2010 Sağ, künt/Right, blunt
BN-2014 Sol, künt/Left, blunt
Bükülebilir/Malleable
26 cm



W1

LANDOLT
BN-2011 Sağ, künt
Right, blunt
26 cm
BN-2015 Sol, künt
Left, blunt
Bükülebilir/Malleable
26 cm



W1

LANDOLT
BP-1603
Küret, bükülebilir
Curette, malleable
26 cm



W1

LANDOLT
BP-1604
Kaşık, bükülebilir
Spoon, malleable
26 cm



W1

LANDOLT
BK-1343
Künt huk/Blunt hook
Bükülebilir/Malleable
26 cm



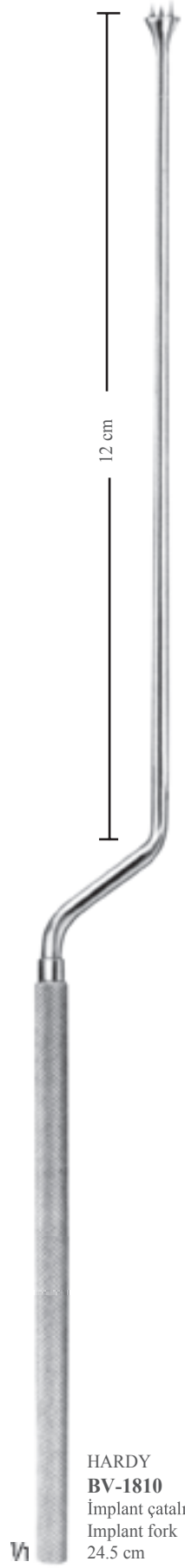



LANDOLT-REULEN
BN-2100 Ø 2.2 mm
Raspa, esnemez
Raspatories, rigid
26 cm

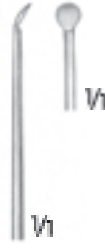

LANDOLT-REULEN
BN-2101 Ø 3.2 mm
Raspa, esnemez
Raspatories, rigid
26 cm



LANDOLT-REULEN
BP-1607 Ø 2.5 mm
Küret, esnemez
Curette, rigid
26 cm



LANDOLT-REULEN
BK-1342 Ø 1.7 mm
Künt huk/Blunt hook
26 cm



FAHLBUSCH
BP-1605 Ø 2.0 mm
Kaşık, bükülebilir
Spoon, malleable
26 cm



FAHLBUSCH
BP-1606 Ø 2.5 mm
Küret, bükülebilir
Curette, malleable
26 cm





RAY
BP-1610 Ø 4 mm
Küret 45° dikey
Curette vertical 45°
18 cm



RAY
BP-1615 Ø 4 mm
Küret 45° Yatay
Curette Horizontal 45°
18 cm

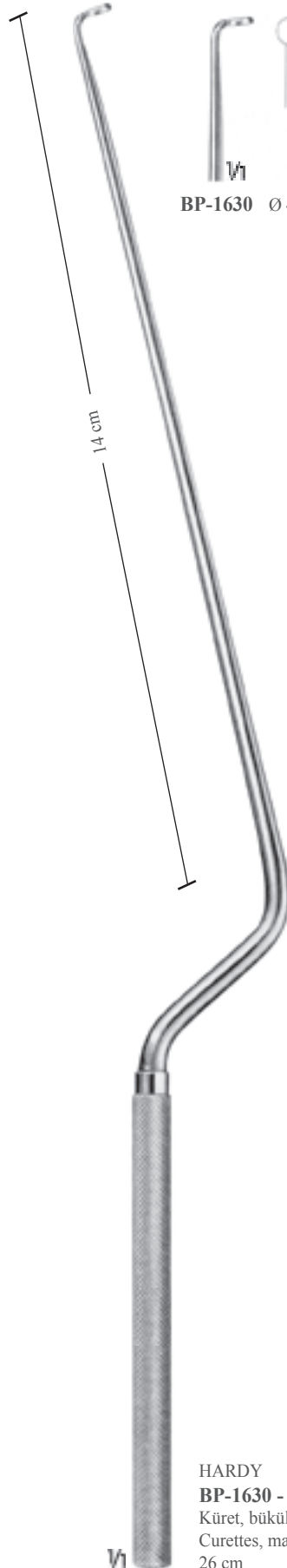

HARDY
BP-1630 - BP-1635
Küret, bükülebilir
Curettes, malleable
26 cm

BP-1630 Ø 4 mm

BP-1635 Ø 6 mm

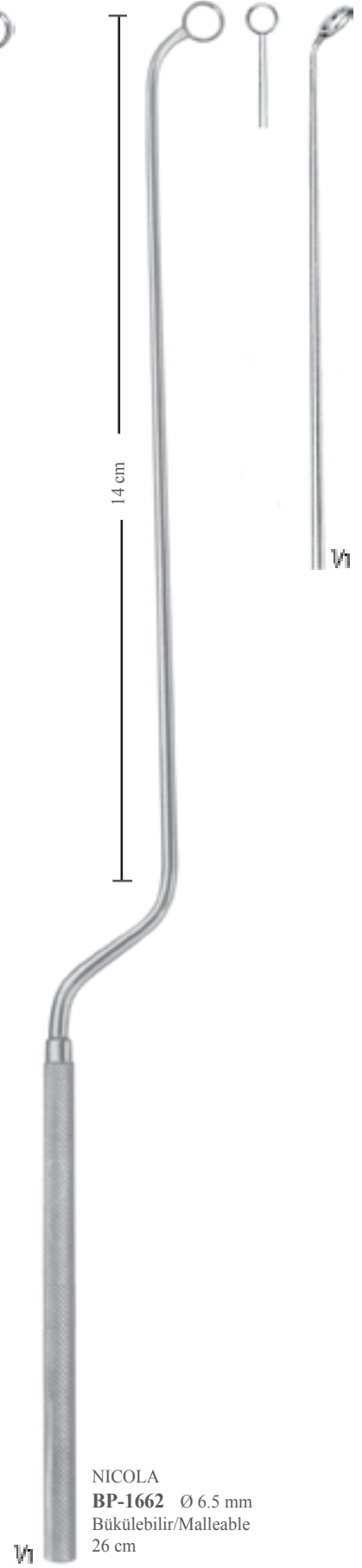
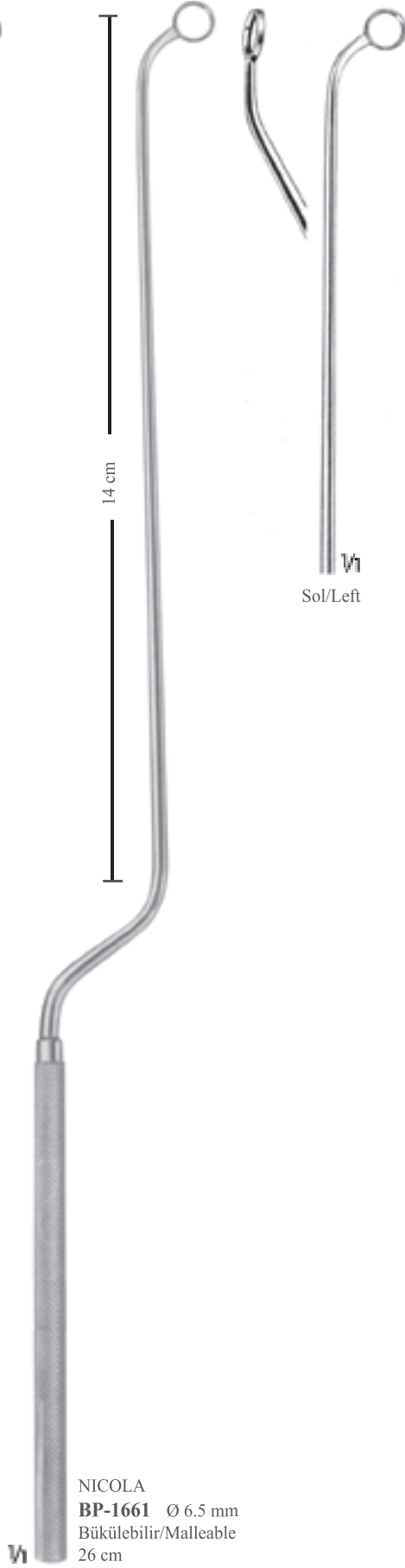
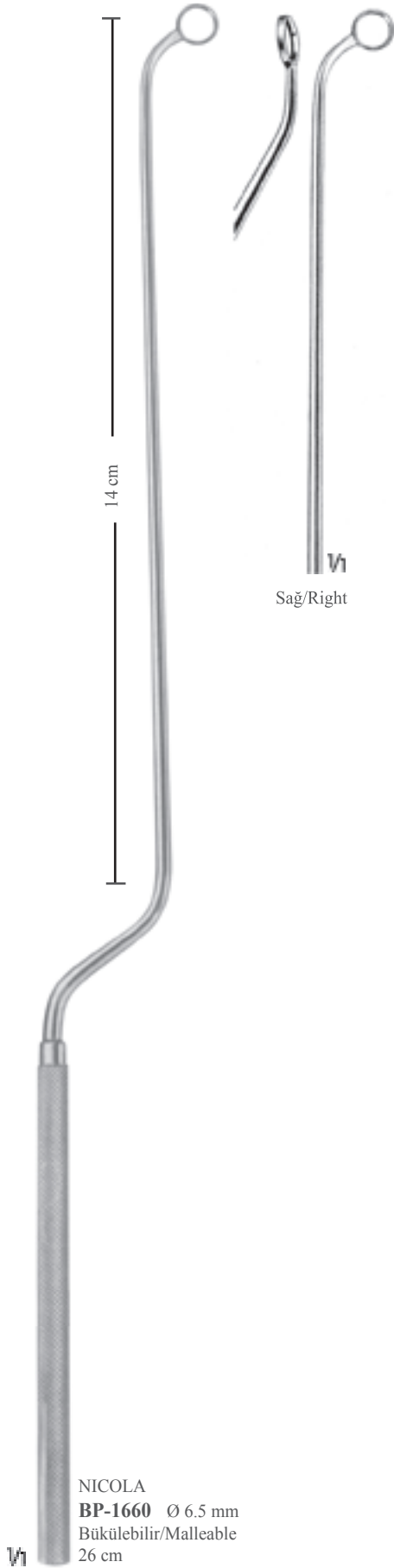



CLOWARD
BM-2471
Sadece ekartör
Retractor only
25 cm

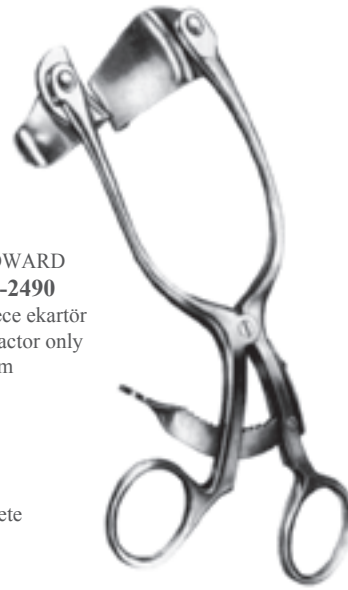

CLOWARD
BM-2490
Sadece ekartör
Retractor only
15 cm

CLOWARD
BM-2470 Komple/Complete
BM-2471
BM-2472 - BM-2498

CLOWARD
BM-2491 Komple/Complete
BM-2490
BM-2494 - BM-2498



40 mm
16 mm
BM-2472



45 mm
16 mm
BM-2473



50 mm
16 mm
BM-2474

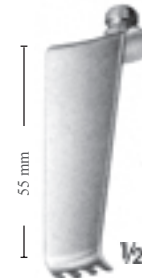

55 mm
16 mm
BM-2475



60 mm
16 mm
BM-2476



40 mm
16 mm
BM-2494



45 mm
16 mm
BM-2495

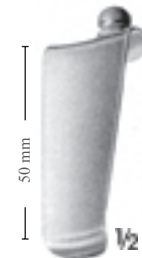

50 mm
16 mm
BM-2496



55 mm
16 mm
BM-2497



60 mm
16 mm
BM-2498



CLOWARD
BM-2530
15.5 cm



CLOWARD
BM-2535
13.5 cm



INGE
BM-2540
17 cm

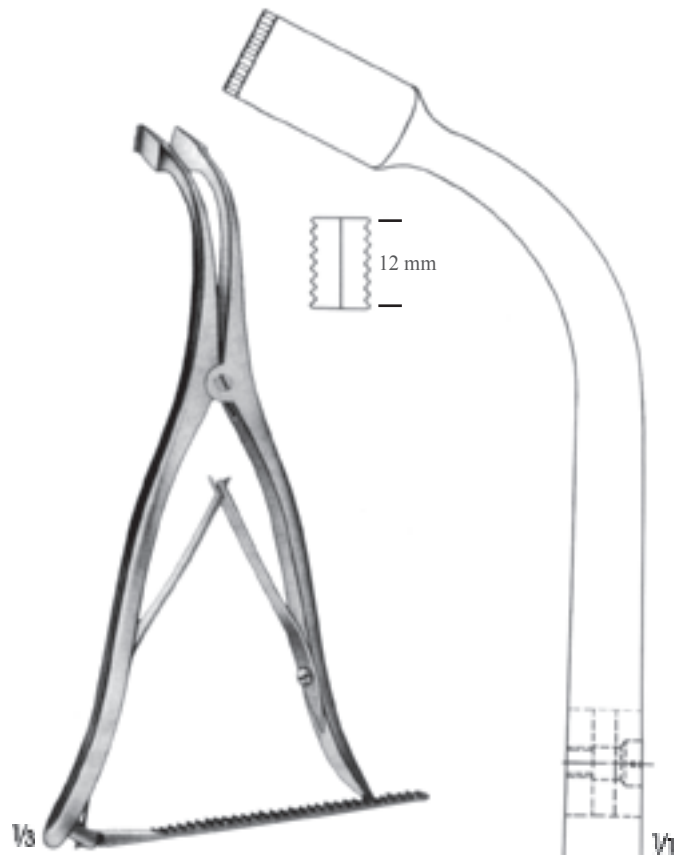

INGE
BM-2550
27.5 cm





CLOWARD
BK-5918 18 mm
BK-5920 20 mm
BK-5923 23 mm
18 cm



CLOWARD
BK-6005
Koter huku/Coutery hook
20 cm



CLOWARD
BK-6002
10 x 8 mm
19 cm



CLOWARD
BK-6001
20 x 12 mm
20 cm



CLOWARD
BN-9800 230 gr.
19 cm



CLOWARD
BN-5175 5 mm
BN-5176 8 mm
BN-5177 10 mm
BN-5178 12 mm
20 cm



CLOWARD
BN-5180
18 cm



CLOWARD
BN-5179
20 cm



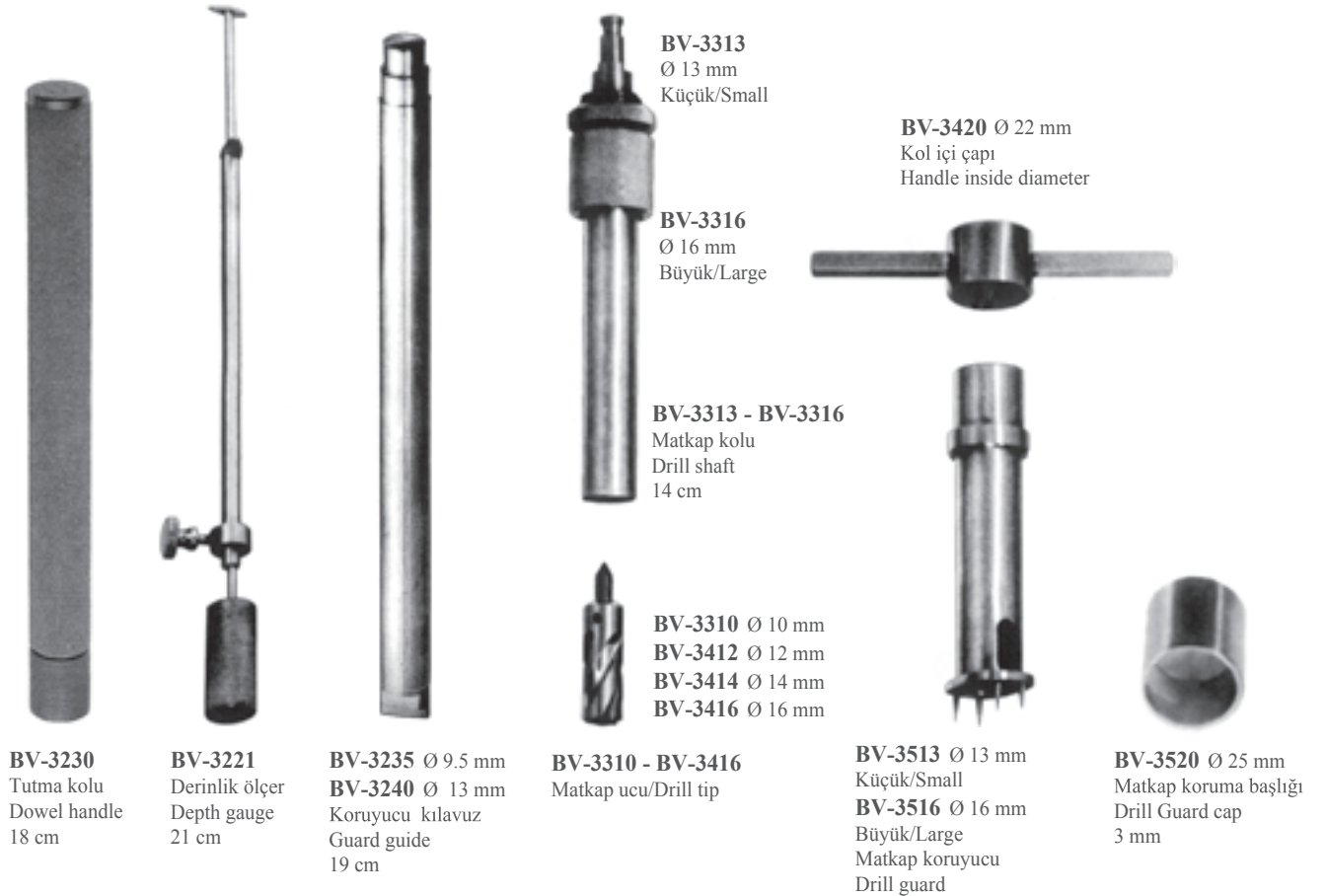
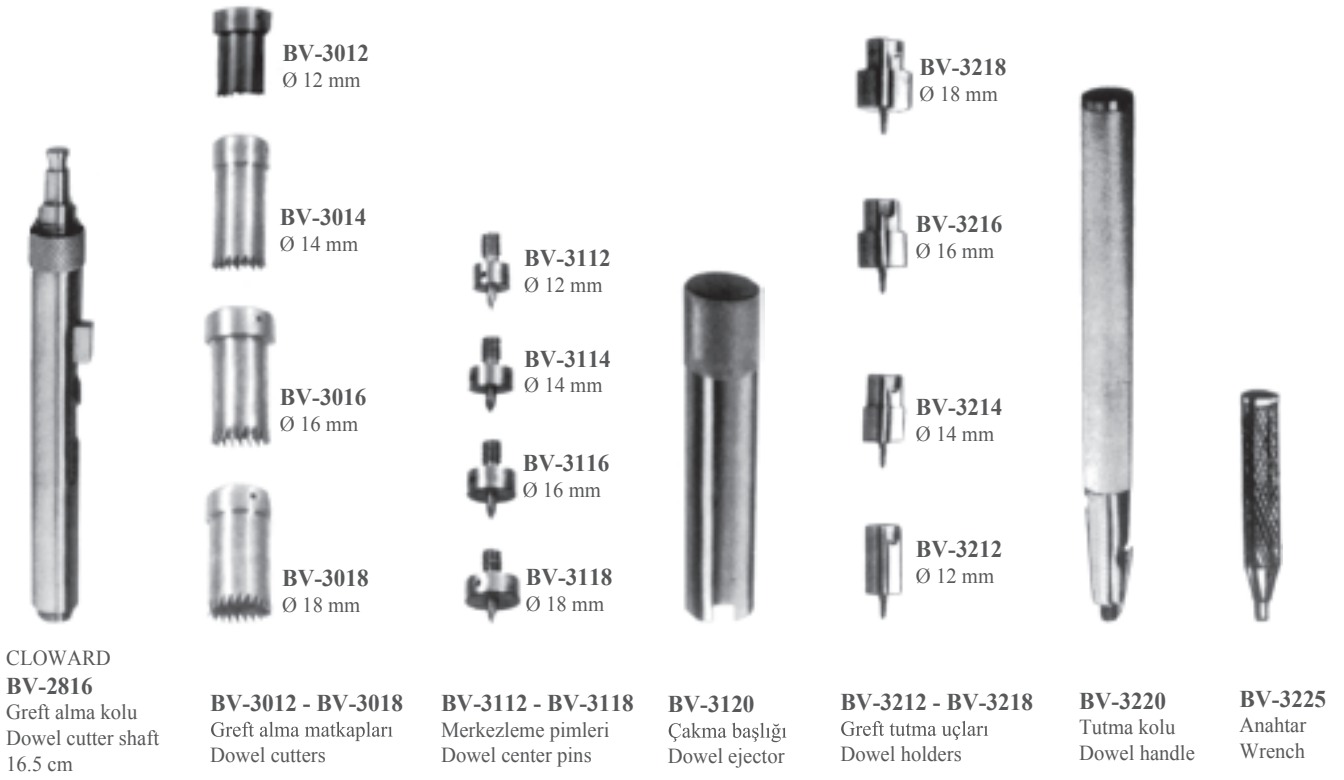



BM-2220 20 x 35 mm
BM-2221 20 x 40 mm
BM-2222 20 x 45 mm
BM-2223 20 x 55 mm
BM-2224 20 x 65 mm
Titanyum bleydler
Blades titanium



BM-2225 40 x 35 mm
BM-2226 40 x 40 mm
BM-2227 40 x 45 mm
BM-2228 40 x 55 mm
BM-2229 40 x 65 mm
BM-2230 40 x 75 mm
Titanyum bleydler
Blades titanium

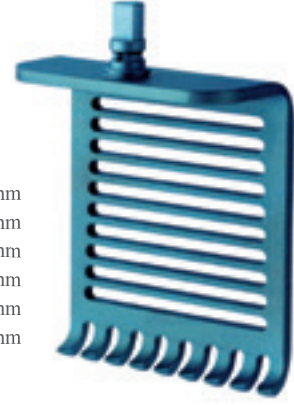

BM-2231 60 x 35 mm
BM-2232 60 x 40 mm
BM-2233 60 x 45 mm
BM-2234 60 x 55 mm
BM-2235 60 x 65 mm
BM-2236 60 x 75 mm
BM-2237 60 x 85 mm
Titanyum bleydler
Blades titanium



BM-2147
Hemi-Laminektomi huk, küçük 38 mm
Hemi-Laminectomy hook, small 38 mm



BM-2149
Hemi-Laminektomi huk, büyük 58 mm
Hemi-Laminectomy hook, large 58 mm



BV-4820
Ekartör bleydleri yerleştirme kolu
Handle for positioning of the retractor blades



BM-9855
Sadece ekartör, BY-2162 ile birlikte
Retractor only, with key BY-2162



BY-2162
Tornavida/Screwdriver
15 cm



BM-2238 30 x 24 mm
BM-2239 35 x 24 mm
BM-2240 40 x 24 mm
BM-2241 45 x 24 mm
BM-2242 50 x 24 mm
BM-2243 55 x 24 mm
BM-2244 60 x 24 mm
BM-2245 65 x 24 mm
BM-2246 70 x 24 mm
Titanyum orta bleydler
Medial blades titanium



BM-2260 30 x 24 mm
BM-2261 35 x 24 mm
BM-2262 40 x 24 mm
BM-2263 45 x 24 mm
BM-2264 50 x 24 mm
BM-2265 55 x 24 mm
BM-2266 60 x 24 mm
BM-2267 65 x 24 mm
BM-2268 70 x 24 mm
Titanyum yan bleydler
Lateral blades titanium



BM-2286 35 x 24 mm
BM-2287 40 x 24 mm
BM-2288 45 x 24 mm
BM-2289 50 x 24 mm
BM-2290 55 x 24 mm
BM-2291 60 x 24 mm
BM-2292 65 x 24 mm
BM-2293 70 x 24 mm
BM-2294 75 x 24 mm
Titanyum künt bleydler
Blunt blades titanium



BM-2332 30 x 24 mm
BM-2333 35 x 24 mm
BM-2334 40 x 24 mm
BM-2335 45 x 24 mm
BM-2336 50 x 24 mm
BM-2337 55 x 24 mm
BM-2338 60 x 24 mm
BM-2339 65 x 24 mm
BM-2340 70 x 24 mm
Titanyum orta bleydler
Medial blades titanium



BM-2300 30 x 24 mm
BM-2301 35 x 24 mm
BM-2302 40 x 24 mm
BM-2303 45 x 24 mm
BM-2304 50 x 24 mm
BM-2305 55 x 24 mm
BM-2306 60 x 24 mm
BM-2307 65 x 24 mm
BM-2308 70 x 24 mm
Titanyum yan bleydler
Lateral blades titanium



BM-2351 35 x 24 mm
BM-2352 40 x 24 mm
BM-2353 45 x 24 mm
BM-2354 50 x 24 mm
BM-2355 55 x 24 mm
BM-2356 60 x 24 mm
BM-2357 65 x 24 mm
BM-2358 70 x 24 mm
BM-2359 75 x 24 mm
Titanyum künt bleydler
Blunt blades titanium



BM-2368 25 x 19 mm
BM-2369 30 x 19 mm
BM-2370 35 x 19 mm
BM-2371 40 x 19 mm
BM-2372 45 x 19 mm
BM-2373 50 x 19 mm
BM-2374 55 x 19 mm
BM-2375 60 x 19 mm
Titanyum dişli bleydler
Teeth blades titanium



BM-2383 25 x 19 mm
BM-2384 30 x 19 mm
BM-2385 35 x 19 mm
BM-2386 40 x 19 mm
BM-2387 45 x 19 mm
BM-2388 50 x 19 mm
BM-2389 55 x 19 mm
BM-2390 60 x 19 mm
Titanyum künt bleydler
Blunt blades titanium



BV-4820
Bleyd tutucu elçek
Handle for blades with side load attachment



BM-2182
Çift hareketli Servikal ekartör
Doble hinged Cervical retractor



BM-2202
Çift hareketli karşı ekartör
Doble hinged retractor used for longitudinal retraction



BM-2192
Karşı ekartör
Counter retractor



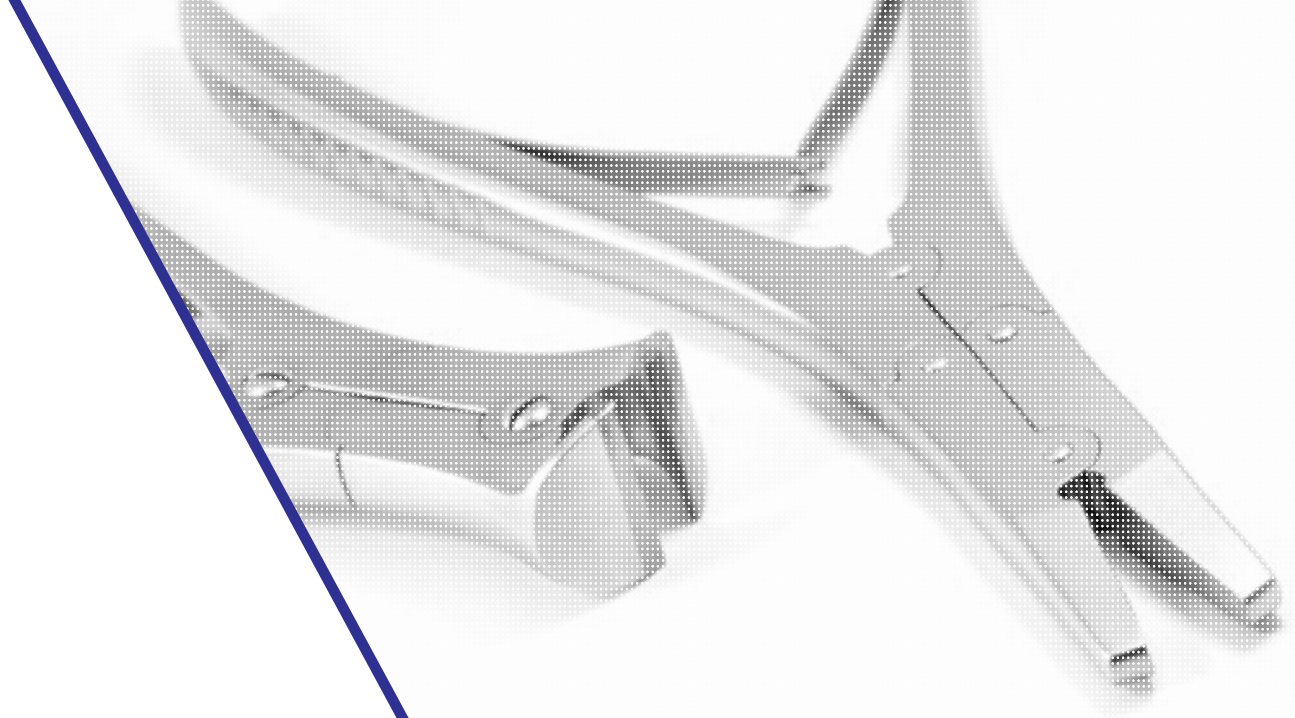

OS

Ortopedik Cerrahi
Orthopedic Surgery





Tek ağız tırtıllı,
One jaw serrated

BC-5209
Küçük alçı ve pansuman için
For small plaster dressings
16 cm



Tek ağız tırtıllı,
One jaw serrated

SEUTIN
BC-5212
Ayrıca bandaj makası
Also to be used as bandage
scissors
23 cm



BC-5345
20 cm

BC-5350
23 cm

ESMARCH
BC-5345 - BC-5350
Tek ağız tırtıllı
One jaw serrated



BERGMANN
BC-5355
Tek ağız tırtıllı
One jaw serrated
23 cm





STILLE
BC-7501
23 cm



Açık Çene
Open Jaw

STILLE
BC-7502
26 cm



Açık çene
Open jaws

STILLE
BC-7503
36 cm



Arkadan takviyeli bleydli
Blade with reinforced back

STILLE
BC-7504
37 cm



WOLFF
BR-8010 18 cm
BR-8015 24 cm
Alçı kesiciler
Plaster breakers



Sökülebilir çeneli
With removable jaws

BR-8005
Alçı ayırıcı
Plaster shear
29 cm



BR-8000
Alçı ayırıcı
Plaster shear
23 cm



HENNIG
BR-8002
Alçı ayırıcı
Plaster shear
27 cm



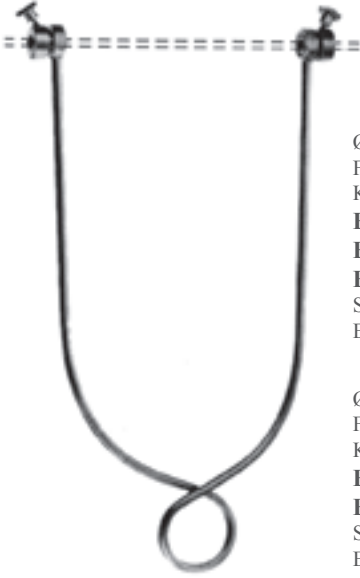

Ø 4 mm STEINMANN çivileri için
For Ø 4 mm STEINMANN pins
Kol ölçüleri/Arms dimensions
BT-1940 16 x 9 cm
BT-1942 21 x 11 cm
BT-1944 21 x 15 cm
STEINMANN çivileri hariç
Except for STEINMANN pins

Ø 5 mm STEINMANN çivileri için
For Ø 5 mm STEINMANN Pins
Kol ölçüleri/Arms dimensions
BT-1946 16 x 9 cm
BT-1948 21 x 11 cm
STEINMANN çivileri hariç
Except for STEINMANN pins



BT-1933
Sabitleme diskleri için tornavida
Screw driver for fixation discs



BV-4725 1 kg
BV-4730 2 kg
BV-4735 5 kg
Ağırlık/Weight

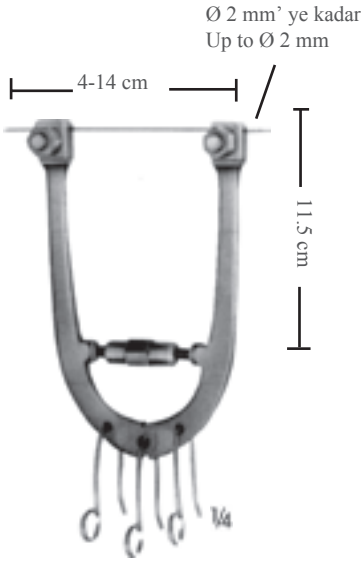

BT-1800
Ayarlı küçük boy, üç kancalı traksiyon aleti
Wire traction bow, adjustable, with 3 hooks,
small size
BT-1935 Uygun anahtar
BT-1935 Suitable wrench

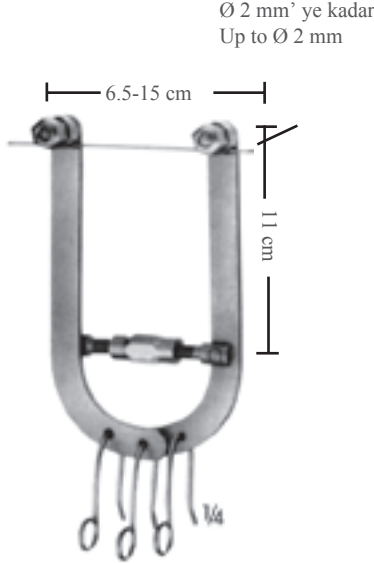

BT-1802
Ayarlı küçük boy, üç kancalı traksiyon aleti
Wire traction bow, adjustable, with 3 hooks,
small size
BT-1935 Uygun anahtar
BT-1935 Suitable wrench

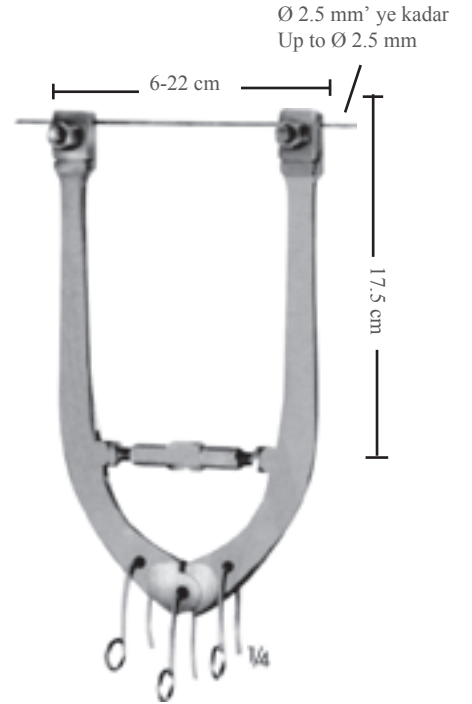

BT-1801
Ayarlı büyük boy, üç kancalı traksiyon aleti
Wire traction bow, adjustable, with 3 hooks,
large size
BT-1935 Uygun anahtar
BT-1935 Suitable wrench

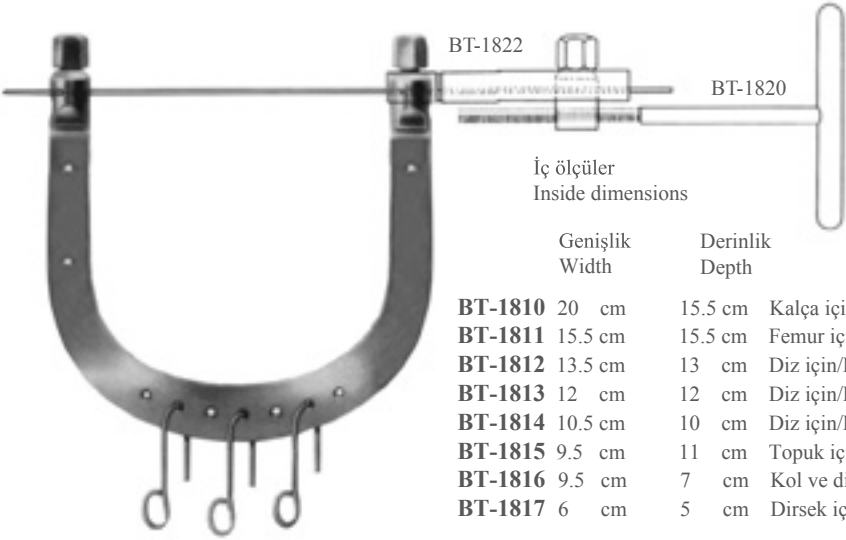

KIRSCHNER

BT-1810 - BT-1816

3 kancalı, Ø 2.5 mm'ye kadar KIRSCHNER
teli ile kullanılan çekirtme

Wire traction bows, to be used with KIRSCHNER
wires up to Ø 2.5 mm, with 3 hooks

İç ölçüler
Inside dimensions

	Genişlik Width	Derinlik Depth	
BT-1810	20 cm	15.5 cm	Kalça için/For the hip
BT-1811	15.5 cm	15.5 cm	Femur için/For the femur
BT-1812	13.5 cm	13 cm	Diz için/For the knee
BT-1813	12 cm	12 cm	Diz için/For the knee
BT-1814	10.5 cm	10 cm	Diz için/For the knee
BT-1815	9.5 cm	11 cm	Topuk için/For the calcaneus
BT-1816	9.5 cm	7 cm	Kol ve dirsek için/For the arm and elbow
BT-1817	6 cm	5 cm	Dirsek için, çocuklar için/For the elbow child size



BT-1820

Kavrama çeneli tel gerdirme aleti
Wire tightener with clamping jaws



BT-1822

BT-1820 Tespit klempini için/For fixation clamp



BT-1935

Traksiyon yayı anahtarı
Wrench, double-ended, for wire
traction bows BT-1810 - BT-1802



BT-1930

Büyük boy traksiyon kancası
Large size traction hook



BT-1938

Küçük boy traksiyon kancası
Small size traction hook



BT-1937

Sabitleme diski kanallı
Fixation disc, slotted



BT-1931

Alüminyum, x ışınlarını
geçirgen
Fixation disc, slotted idem,
alüminyum transparent to
X-rays



BT-1932

Sabitleme diski, kanallı
Fixation disc, slotted

10 - 40 mm

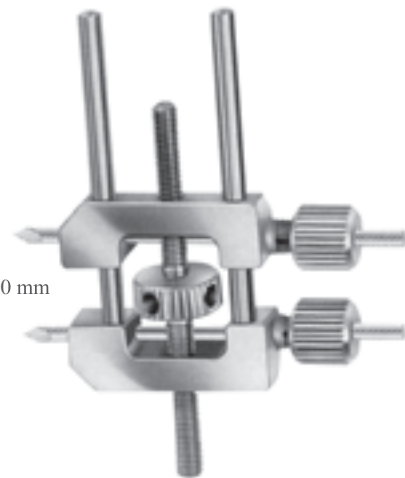

BV-2653

Küçük distraktör
Small distractor
Tel Ø 3.0 mm
For wires Ø 3.0 mm





BF-7300
27.5 cm



BF-7301
28.5 cm



BF-7302
30.5 cm

DEMEL
BF-7300 - BF-7302
Tel kılavuzları/Wire guides



BF-7400 - BF-7401



BF-7400
24 cm



BF-7401
27 cm

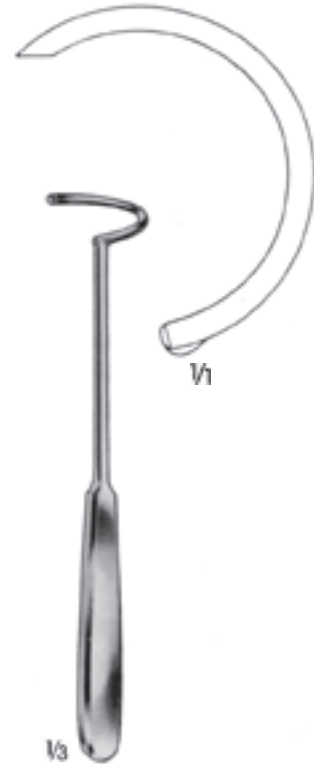

BF-7402
22.5 cm



Implantlar için kullanılan malzemeden yapılmış hareketli uç. Bükülürken hareketli başlık sabit kalır bu sayede tel kalmaz.

Movable tip made of material used for implants. While twisting the movable head remains stable, therefore the wire will not slip off.

1/2

LOUTE
BF-7113

Tel gerici, geliştirilmiş model, hareketli uç ile 1.0 mm çapına kadar olan teller için
Wire tightener, improved pattern, with movable tip, for wires up to 1.0 mm diam
22 cm

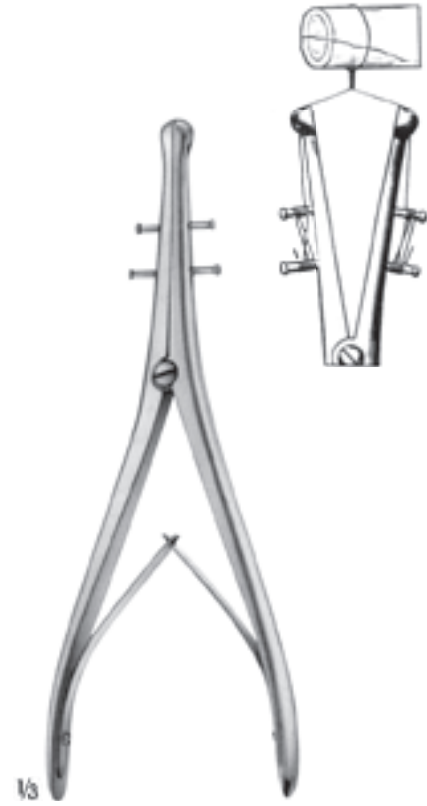

1/3

DEMEL
BF-7114

Gerdirek tel sıkma, büküm pensi
Wire tightening-and twisting forceps
27 cm



BF-7202 Ø 0.2 mm
BF-7203 Ø 0.3 mm
BF-7204 Ø 0.4 mm

BF-7205 Ø 0.5 mm
BF-7206 Ø 0.6 mm
BF-7207 Ø 0.7 mm

BF-7208 Ø 0.8 mm
BF-7209 Ø 0.9 mm
BF-7210 Ø 1.0 mm

BF-7212 Ø 1.2 mm
BF-7215 Ø 1.5 mm

BF-7202 - BF-7215

Yumuşak doku uyumlu tel 10 m
Wire, soft, tissue compatible, in coils of 10 m

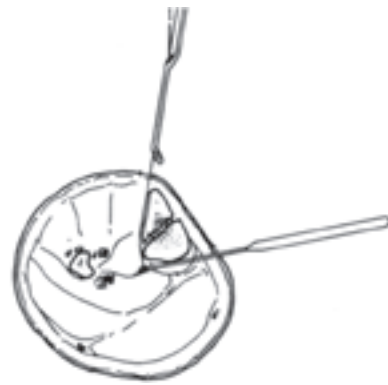

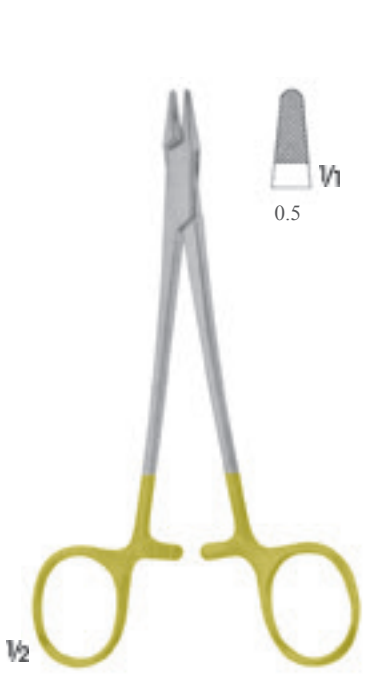

BF-5250
Tel bükücü/Wire twister
Bağlama pensi/Ligature forceps
15 cm



BF-5260
Tel bükücü/Wire twister
Bağlama pensi/Ligature forceps
15 cm

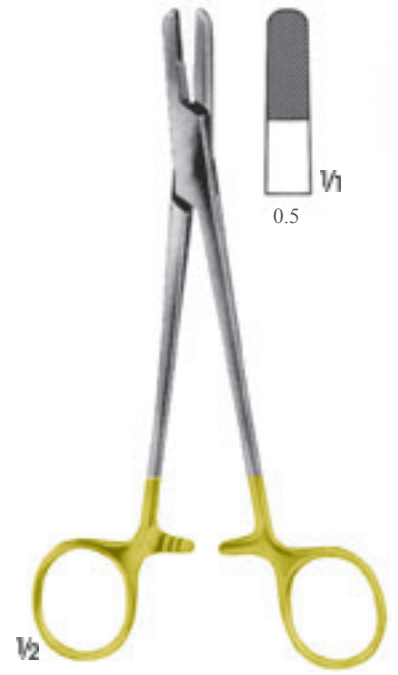

BF-5265
Sternum dikişi için
For sternum suture
17.5 cm



BERRY
BF-5255
Tel bükücü/Wire twister
Bağlama pensi/Ligature forceps
18.5 cm



BAUMGARTNER
BF-5280
Tel bükücü/Wire twister
Bağlama pensi/Ligature forceps
20 cm

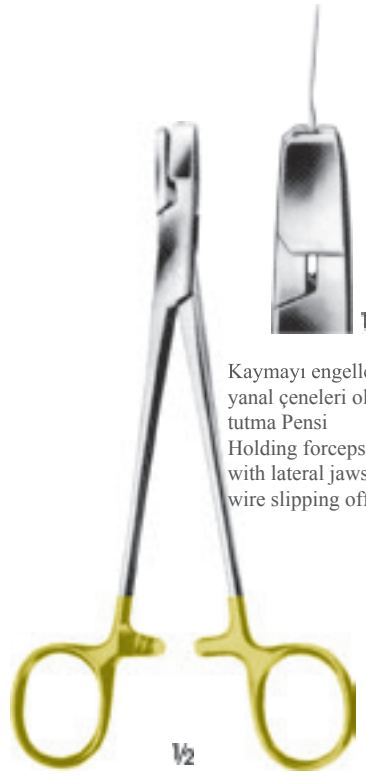

BR-8020
17 cm

Kaymayı engellemek için yanıl çeneleri olan serklaj teli tutma Pensi
Holding forceps for cerclage wire, with lateral jaws to avoid wire slipping off



**MARBURG MODELL
BR-8025**
Tel tutma pens,
Düz burunlu, tırtıllı ağız
Wire holding forceps,
Flat nosed, with serrated jaws
14 cm



**GOSLEE
BR-8110**
Tel bükücü, düz burunlu
Wire twister, flat nosed
14 cm



BR-8100 - BR-8101
Tel bükücü, düz burunlu
Wire twister, flat nosed
17 cm



BR-8230
19.5 cm



BR-8102
Tel tutma pens, düz burunlu
Wire holding forceps, flat nosed
19 cm



BR-8103 - BR-8104
Tel çıkarma pens
Extraction pliers for boring
wires



BR-8103
13 cm



BR-8104
18 cm





BR-8200
Yuvarlak pens
Round pliers
18 cm



BR-8203
Tel çıkartıcı pens
Extraction pliers for
wires
14.5 cm



BR-8201
Tel çıkartıcı pens
Extraction pliers
for wires
18 cm



BR-8202
Tel çıkartıcı pens
Extraction pliers for
wires
18 cm



V₂

BR-8210
Ø 1.8 mm kadar teller için
bükme pens
Bending pliers for wires up to
1.8 mm diam.



V₂

BR-8220
Paralel düz tutucu
Flat-nosed pliers, parallel
18.5 cm



V₁



V₂

BR-8225
Mengene kavramalı, ayarlı pense
Vise grip pliers set
20 cm



V₁



Özel sertleştirilmiş kesici ağız
Specially hardened cutting edges



Özel sertleştirilmiş kesici ağız
Specially hardened cutting edges



Yumuşak tel için Ø 0.5 mm
For soft wire Ø 0.5 mm
Sert tel için Ø 0.3 mm
For hard wire Ø 0.3 mm

W2

ANGLE
BR-8240
13 cm



Yumuşak tel için Ø 0.6 mm
For soft wire Ø 0.6 mm
Sert tel için Ø 0.4 mm
For hard wire Ø 0.4 mm

W2

BR-8250
13 cm

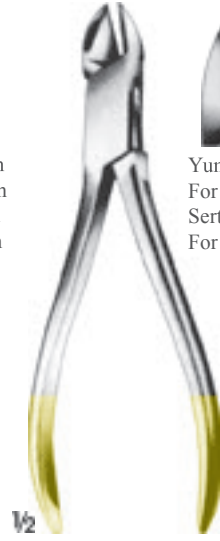

Yumuşak tel için Ø 1.5 mm
For soft wire Ø 1.5 mm
Sert tel için Ø 1.0 mm
For hard wire Ø 1.0 mm

W2

BR-8255
Tel kesme pensi
Wire cutting pliers
14 cm



Sert metal kesici ağız
Hard metal cutting edges

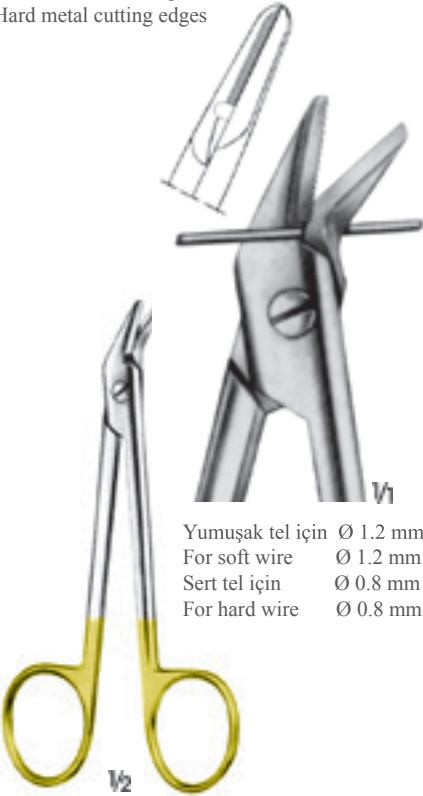

Yumuşak tel için Ø 1.2 mm
For soft wire Ø 1.2 mm
Sert tel için Ø 0.8 mm
For hard wire Ø 0.8 mm

W2

BC-7015
Tek ağız tırtıllı
One jaw serrated
12 cm

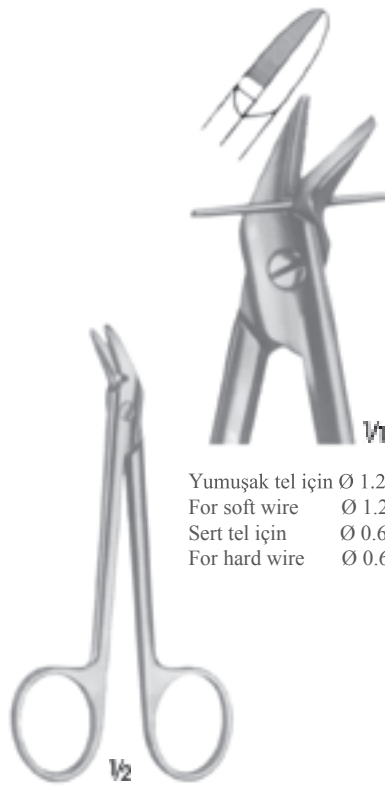

Yumuşak tel için Ø 1.2 mm
For soft wire Ø 1.2 mm
Sert tel için Ø 0.6 mm
For hard wire Ø 0.6 mm

W2

BC-5390
Tek ağız tırtıllı
One jaw serrated
12 cm

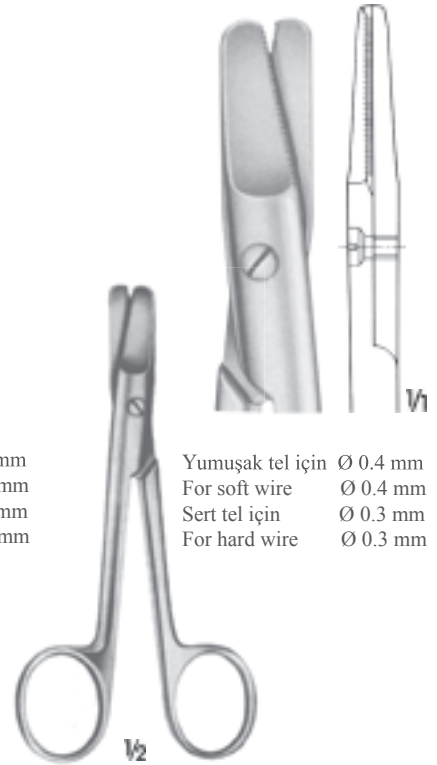

Yumuşak tel için Ø 0.4 mm
For soft wire Ø 0.4 mm
Sert tel için Ø 0.3 mm
For hard wire Ø 0.3 mm

W2

HARVEY
BC-5385
Çift ağız tırtıllı
Both jaws serrated
12.5 cm



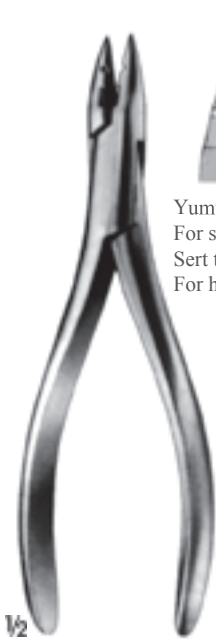

BR-8265
16 cm



Yumuşak tel için Ø 1.5 mm
For soft wire Ø 1.5 mm
Sert tel için Ø 1.2 mm
For hard wire Ø 1.2 mm

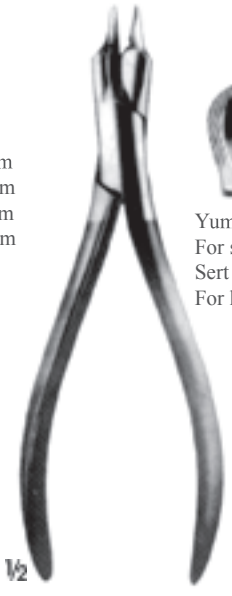

BR-8260
15 cm



Yumuşak tel için Ø 1.5 mm
For soft wire Ø 1.5 mm
Sert tel için Ø 1.0 mm
For hard wire Ø 1.0 mm



Özel sertleştirilmiş kesici ağız
Specially hardened cutting edges

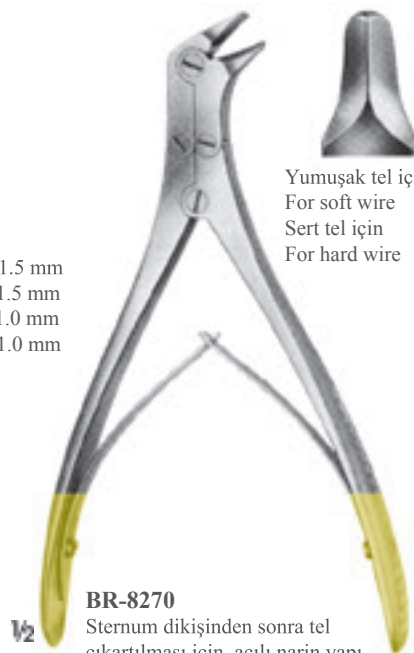

BR-8270
Sternum dikişinden sonra tel çıkartılması için açılı narin yapı
Angled slender pattern for wire removal after sternum suture
17 cm



Yumuşak tel için Ø 0.9 mm
For soft wire Ø 0.9 mm
Sert tel için -
For hard wire -



Özel sertleştirilmiş kesici ağız
Specially hardened cutting edges



HARVEY BR-8401
Tel kesme pens
Wire cutting pliers
23 cm



Yumuşak tel için Ø 3.0 mm
For soft wire Ø 3.0 mm
Sert tel için Ø 2.2 mm
For hard wire Ø 2.2 mm



BR-8310
Yanal kesme
Lateral cutting
23.5 cm



Yumuşak tel için Ø 3.0 mm
For soft wire Ø 3.0 mm
Sert tel için Ø 2.2 mm
For hard wire Ø 2.2 mm



Özel sertleştirilmiş kesici ağız
Specially hardened cutting edges

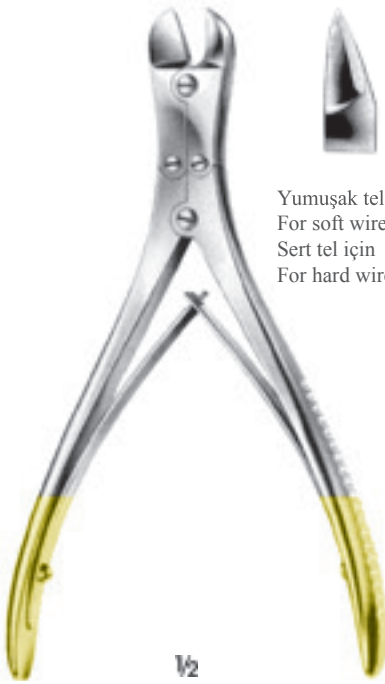

Yumuşak tel için Ø 2.0 mm
For soft wire Ø 2.0 mm
Sert tel için Ø 1.5 mm
For hard wire Ø 1.5 mm

REILL
BR-8275
Kemiğe yakın olan
telleri kesme
For cutting off wires close
to the bone
17.5 cm



Yumuşak tel için Ø 2.0 mm
For soft wire Ø 2.0 mm
Sert tel için Ø 1.5 mm
For hard wire Ø 1.5 mm

BR-8300
Tel kesiciler, ön ve yan kesme
hareketli
Wire cutters, front-and lateral
cutting action
18 cm



Özel sertleştirilmiş kesici ağız
Specially hardened cutting edges



Yumuşak tel için Ø 3.0 mm
For soft wire Ø 3.0 mm
Sert tel için Ø 2.2 mm
For hard wire Ø 2.2 mm

HARVEY
BR-8400
Tel kesme pensi
Wire cutting pliers
23.5 cm



Sert metal kesici ağız
Hard metal cutting edges



Yumuşak tel için Ø 2.5 mm
For soft wire Ø 2.5 mm
Sert tel için Ø 2.0 mm
For hard wire Ø 2.0 mm

BR-8320
Tel kesme pensi
Wire cutting pliers
24 cm





Yumuşak tel için Ø 2.0 mm
For soft wire Ø 2.0 mm
Sert tel için Ø 1.5 mm
For hard wire Ø 1.5 mm

BR-8330
14.5 cm



Yumuşak tel için Ø 1.5 mm
For soft wire Ø 1.5 mm
Sert tel için Ø 1.0 mm
For hard wire Ø 1.0 mm

BR-8410
14.5 cm



Yumuşak tel için Ø 3.5 mm
For soft wire Ø 3.5 mm
Sert tel için Ø 2.5 mm
For hard wire Ø 2.5 mm

BR-8411
16.5 cm

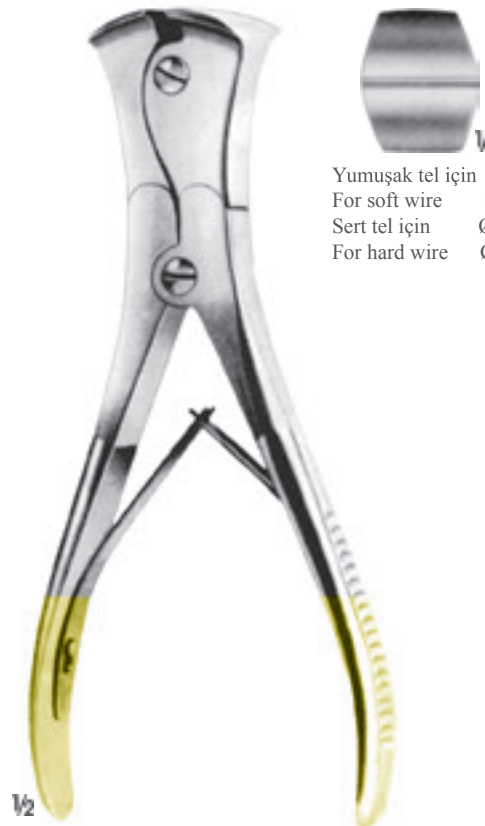

Yumuşak tel için Ø 3.0 mm
For soft wire Ø 3.0 mm
Sert tel için Ø 2.0 mm
For hard wire Ø 2.0 mm

BR-8340
22 cm



BR-8413

Ø 6 mm'ye kadar tel, vida, çivi vs. kesmek için
For cutting off wires, screws, pins, etc. up to Ø 6 mm
47 cm



BR-8412

Ø 3 mm'ye kadar tel, vida, çivi vs. kesmek için
For cutting off wires, screws, pins, etc. up to Ø 3 mm
32 cm





143° buhar sterilizatörlerinde steril edilebilir.
Can be sterilized in a steam sterilizer up to 143°



**OBWEGESER
BF-6809**
19.5 cm



**OBWEGESER
BF-6808**
23 cm

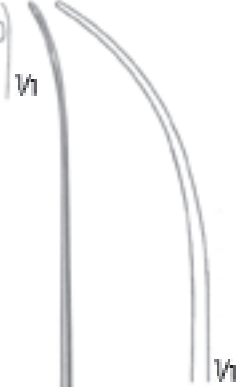

BF-6811
Bükülebilir/Malleable
23 cm



**BRUNNER
BF-7001**
30 cm



**WAGNER
BF-7405**
Tel uzatma/Wire extension
30 cm



W2

BY-1518
Oyucu (Biz)
Reamer (Awl)
18 cm



W2

BY-1521
Oyucu (Biz)
Reamer (Awl)
21.5 cm



W2

CHAMPIONNIERE
BY-1545
Kemik matkabı
Bone drill
17 cm

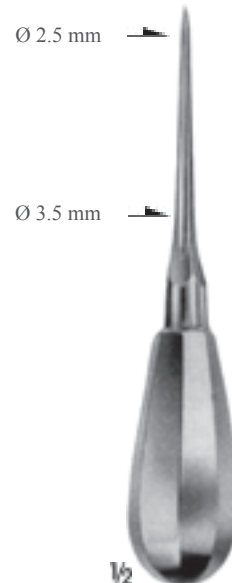

W2

BY-1515
Oyucu (Biz)
Reamer (Awl)
15 cm





BY-1442
Delme başlığı
Drilling chuck
Ø 0.8-2 mm
15 cm



BY-1546
Delme başlığı Ø 4.5 mm
Drilling chuck Ø 4.5 mm
BY-1535 anahtarı ile
With key BY-1535
14 cm



BY-1547
Delme başlığı Ø 6.35 mm
Drilling chuck Ø 6.35 mm
BY-1530 anahtarı ile
With key BY-1530
16 cm



BY-1530
Anahtar/Key



BY-1525
Anahtar/Key



BY-1520
BY-1525 Anahtarı ile
With key BY-1525

İç çap/Inside Ø 6.7 mm
Dış çap/Outside Ø 8.7 mm



BY-1505
İç çap/Inside Ø 3.9 mm
Dış çap/Outside Ø 5 mm



BY-1508
İç çap/Inside Ø 6.4 mm
Dış çap/Outside Ø 8 mm

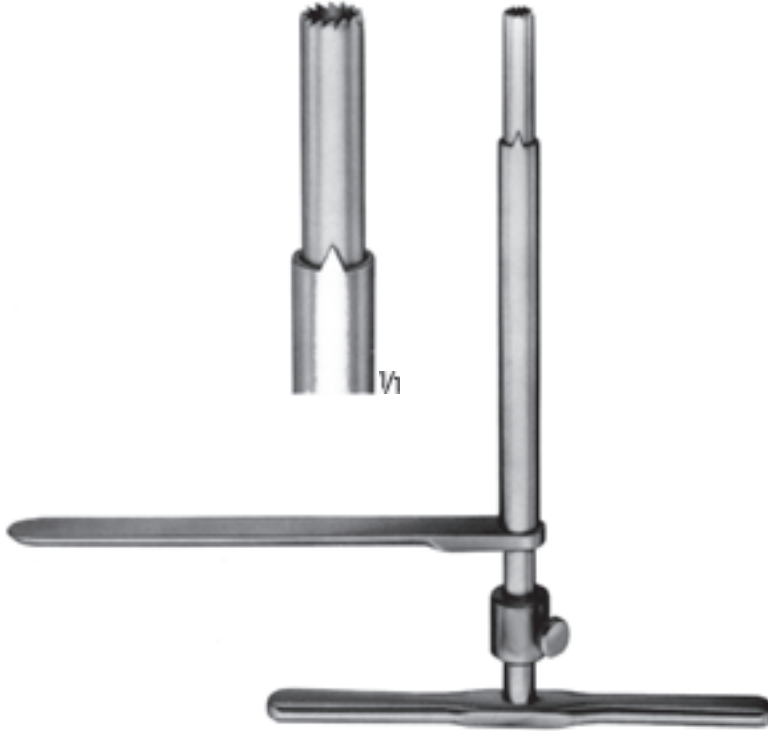

R.N.O.H.
BY-2800
Kemik biyopsi trapanı
Bone biopsy trephine
19.5 cm



BY-1505 - BY-1508
Kemik biyopsi trapanı
Bone biopsy trephine
16 cm





Ayarlı sap
Adjustable handle

BY-1690
El matkabı/Hand drill only
28 cm



BY-1530
Anahtar/Key

El matkabı paslanmaz, 3 çene ağızlı, 6.35 mm çaplı başlıklar için uygundur. Orjinal 'Jacops Chuck' aynaları ile ve BY-1530 anahtarı ile, anahtarlı veya anahtarsız kullanılabilir.

Hand drill, stainless, original 'Jacops Chuck' and key BY-1530
Can be used with or without the key.



BUNNEL
BY-1695

Küçük el matkabı, KIRSCHNER tel için delikli küçük el matkabı, 3 çene ağızlı, 4 mm çaplı başlıklar için uygundur.

Small hand drill, canulated for KIRSCHNER wires, with 3-jaw chuck, to fit any size of shanks up to 4.0 mm diameter.

BY-1535 anahtarı ile
With key BY-1535
16 cm



BY-1535
Anahtar/Key



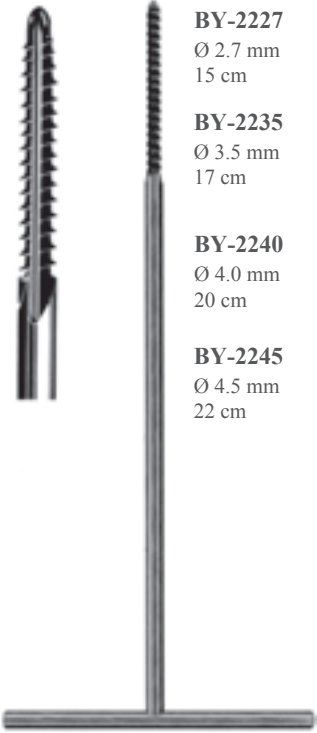

BY-2227

Ø 2.7 mm
15 cm

BY-2235

Ø 3.5 mm
17 cm

BY-2240

Ø 4.0 mm
20 cm

BY-2245

Ø 4.5 mm
22 cm

BY-2227 - BY-2245
Kemik tapları/Bone taps



Ölçme sınırı
Measuring
6 - 40 mm

Vidalar için
For screws
Ø 2.7 mm
Ø 3.5 mm
Ø 4.0 mm

BY-2315
15.5 cm



Ölçme sınırı
Measuring
10 - 60 mm

Vidalar için
For screws
Ø 4.5 mm
Ø 6.5 mm

BY-2322
22 cm



BV-4330
Plak tutucu pens
Plate holding forceps
20 cm



BY-1880
20 cm

BY-1885
25 cm



BY-1870
20 cm

BY-1875
25 cm



BY-1855
20 cm

BY-1865
25 cm



BY-1850
20 cm

BY-1860
25 cm



BY-1735
20 cm

BY-1835
25 cm



BY-1725
20 cm

BY-1825
25 cm

3.5 mm

2.5 mm



Elmas Kesici Ağız
With Carbide Cutting Edges

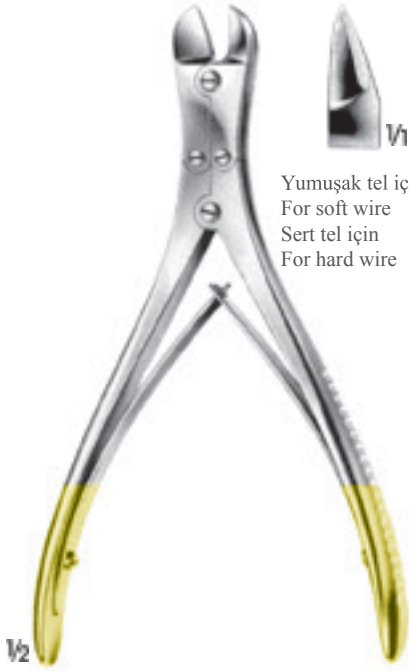

Yumuşak tel için Ø 2.0 mm
For soft wire Ø 2.0 mm
Sert tel için Ø 1.5 mm
For hard wire Ø 1.5 mm

REILL
BR-8275

Kemiğe yakın olan telleri kesme
For cutting off wires close to the bone
17.5 cm



Düz ağız
Smooth jaw



1/2

GOSLEE
BR-8110

Tel bükücü, düz burunlu
Wire twister, flat nosed
14 cm



Tırtıllı ağız
Serrated jaw



BR-8802
15 cm



BY-3415
1.5 mm



BY-3425
20 cm



BY-3431
BY-3432 - BY-3433
ile kullanılır.
To be use with
BY-3432 and BY-3433



BY-3430
Kılavuz/Guide
23 cm



BY-3432
Ø 2.5 mm



BY-3433
Pin/Pin

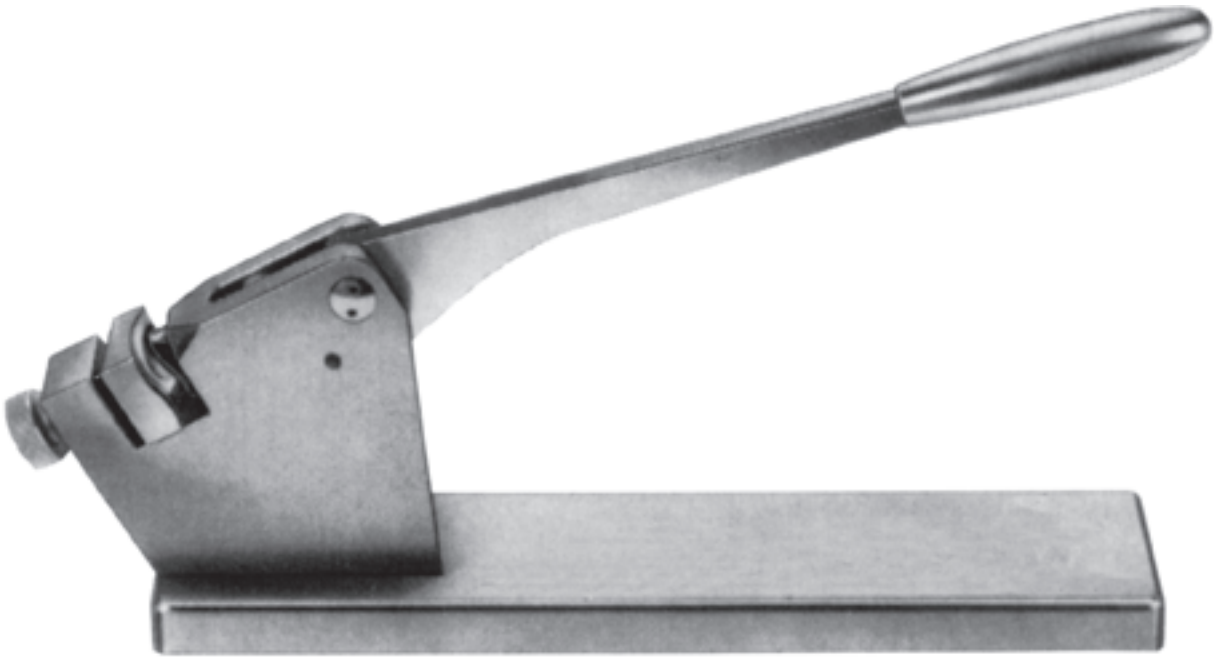

BV-4440

Bükme ve kıvrırma aparatı

Plate bending and contouring device



2.7 mm
3.5 mm

BV-4427

Bükme kolu
Bending iron
14 cm



3.5 mm
2.7 mm

BV-4435

Bükme kolu
Bending iron
14 cm



2.2 mm

BV-4422

Bükme kolu
Bending iron
16 cm

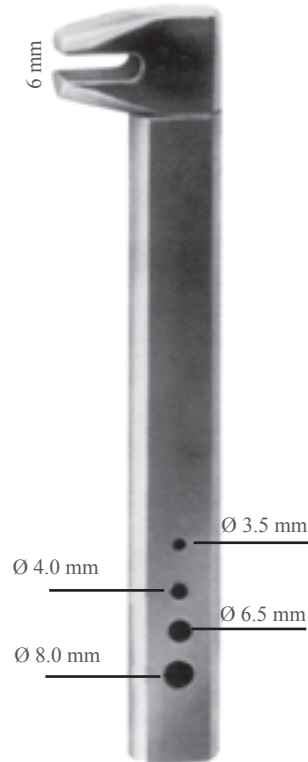

6 mm
Ø 4.0 mm
Ø 3.5 mm
Ø 6.5 mm
Ø 8.0 mm

JEWETT

BV-4436

Bükme kolu
Bending iron
20 cm



6 mm
Ø 13 mm x 15 cm boy/Long

JEWETT

BV-4437

Bükme kolu
Bending iron
20 cm



BR-8700
20 cm



BN-9201 9 mm
Kırık vida çıkartıcı guj
Broken screw extractor guj
22 cm

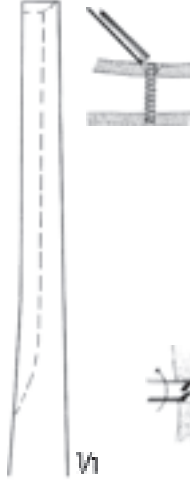

BY-2935 Ø 3.5 mm
BY-2945 Ø 4.5 mm
BY-2965 Ø 6.5 mm

BY-2835 Ø 3.5 mm
BY-2845 Ø 4.5 mm
BY-2865 Ø 6.5 mm

BY-2735 Ø 3.5 mm
BY-2745 Ø 4.5 mm
BY-2765 Ø 6.5 mm

BY-2535 Ø 3.5 mm
BY-2545 Ø 4.5 mm
BY-2565 Ø 6.5 mm



BY-2940
10 cm



BY-2944
10 cm



BY-2925 Ø 2.5 mm
BY-2926 Ø 3.5 mm
14 cm



BY-2927 Ø 3.5 mm
18 cm



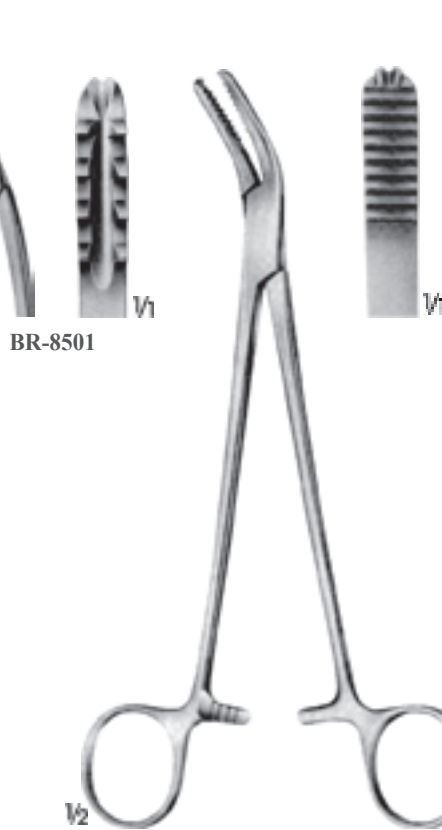
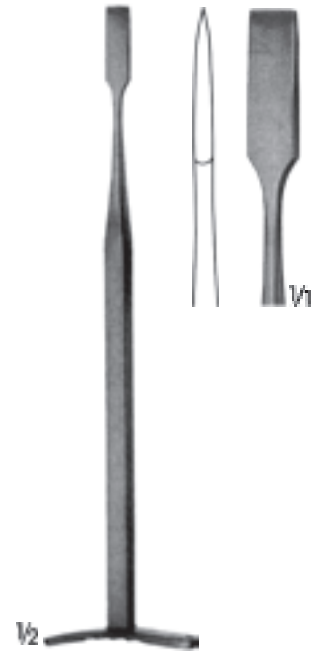
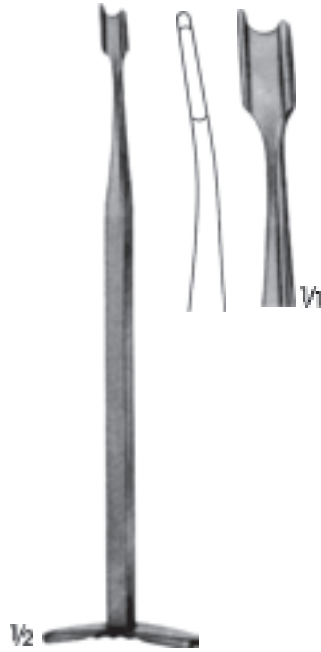
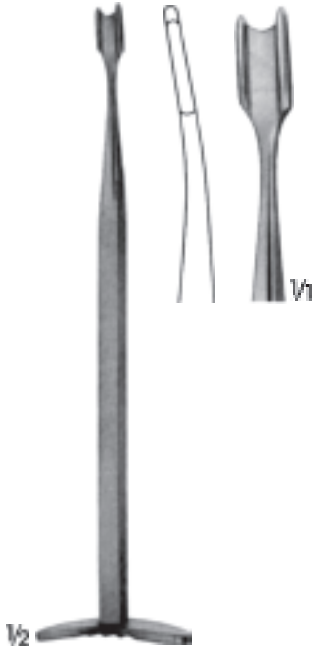

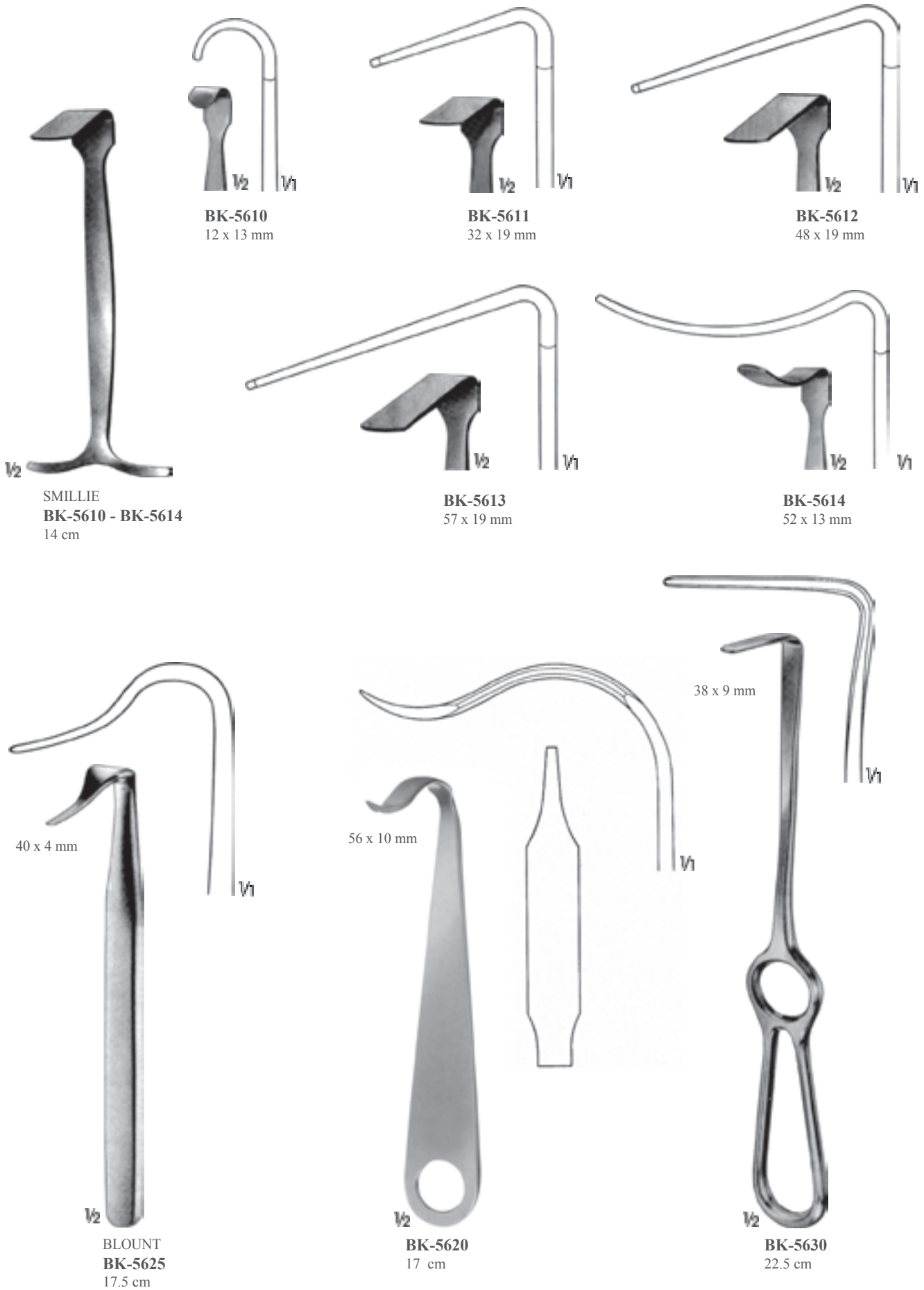



KUNTSCHER
BY-3106 Ø 6 mm
BY-3107 Ø 7 mm
BY-3108 Ø 8 mm
BY-3109 Ø 9 mm
BY-3110 Ø 10 mm
BY-3111 Ø 11 mm
BY-3112 Ø 12 mm
BY-3113 Ø 13 mm
BY-3114 Ø 14 mm
BY-3115 Ø 15 mm
BY-3116 Ø 16 mm
Sabit oyucu
Fixed reamer
50 cm



KUNTSCHER
BY-3206 Ø 6 mm
BY-3207 Ø 7 mm
BY-3208 Ø 8 mm
BY-3209 Ø 9 mm
BY-3210 Ø 10 mm
BY-3211 Ø 11 mm
BY-3212 Ø 12 mm
BY-3213 Ø 13 mm
BY-3214 Ø 14 mm
BY-3215 Ø 15 mm
BY-3216 Ø 16 mm
Bükülebilir oyucu
Malleable reamer
48 cm



BV-4575
KUNTSCHER "T" kolu,
bükülebilir oyucular için
"T" Wrench, for malleable
reamers

BV-4566
Çıkartıcı/Extractor
25 cm



BV-4567
Çıkartıcı/Extractor
27 cm



BV-4560
İtici/Pusher
25 cm



BV-4568
MORE protez çıkartıcı
MORE protheses extractor
50 cm

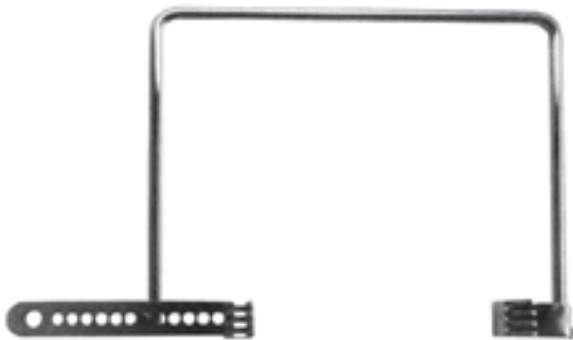

BM-9850
Kalça ekartörü
Hip retractor



BV-4740
Zincirli ağırlık
Weight with chain
1 kg





BV-4569
Çement itici
Cement pusher
30 cm



BV-4570
Çement itici
Cement pusher
30 cm



BN-9505 - BN-9515
Osteotom ve guj
Chisel and gouge
35 cm



BN-9505
5 mm



BN-9510
5 mm



BN-9513
5 mm



BN-9506
7 mm



BN-9511
7 mm



BN-9514
7 mm



BN-9507
10 mm



BN-9512
10 mm



BN-9515
7 mm



Osteotom/Çizil
Osteotome/Chisel



Guj/Gouge



Guj/Gouge



BS-5880
40 cm



BY-3406
Ø 6 mm
40 cm



BY-3408
Ø 8 mm
40 cm



BY-3410
Ø 10 mm
40 cm



BV-4571
Çekiç / Mallet
22 cm



BV-4572 Ø 7 mm
BV-4573 Ø 9 mm
BV-4574 Ø 11 mm
Çement çıkartıcı
Cement extractor
60 cm



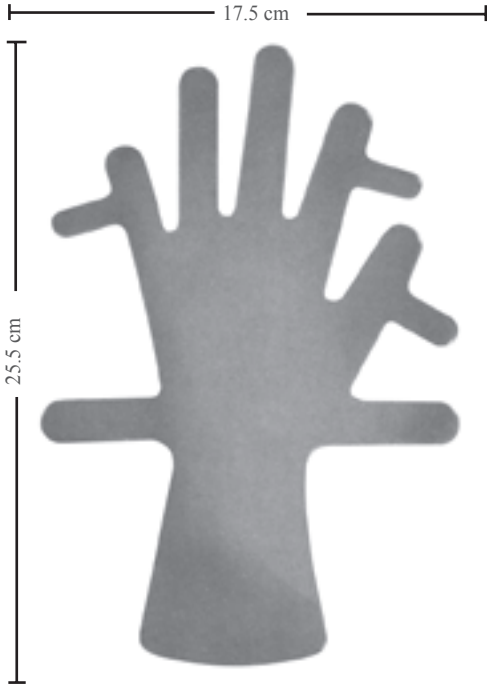

BV-4580

Çocuklar için el sabitleyici, yumuşak
Children hand control, soft

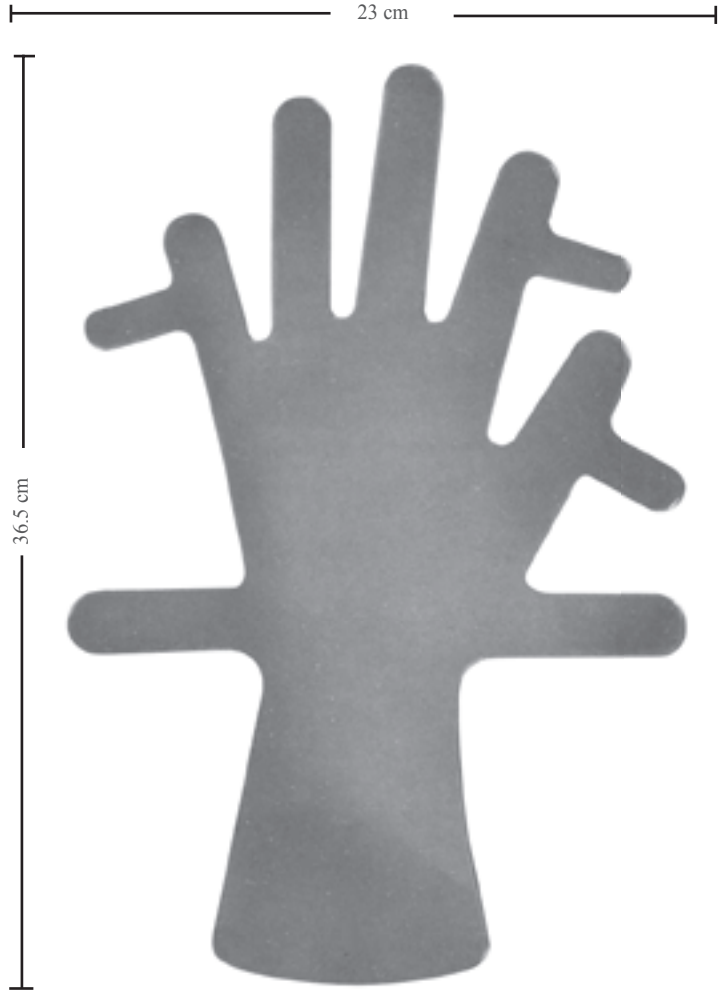

BV-4581

Yetişkinler için el sabitleyici, yumuşak
Used stabilizer for adults, soft



BR-8803

Tırnak çıkarma pensi
Nail splitting forceps
13 cm



BR-8804

Tırnak çıkarma pensi
Nail extracting forceps
13.5 cm



BR-8600

Parmak yüzük testere
Finger ring saw
15 cm



1/2

**JOSEPH
BY-3510**
El testere
Hand saw
17 cm



1/2

**LINDEMANN
BY-3515**
El testere
Hand saw
20 cm



1/2

**SYSTRUNK
BC-5370**
Parmak tırnak kesme makası
Scissors for splitting finger nails
13 cm



1/2

**JACKSON
BE-3208**
Tendon tutucu pens
Tendon seizing forceps
4 x 5 diş/4 x 5 teeth
15 cm



1/2

**HERZ
BE-3209**
Tendon tutucu pens
Tendon seizing forceps
15.5 cm



1/2

BE-3301
Tendon geçmeli pens
Tendon interlacing forceps
15 cm

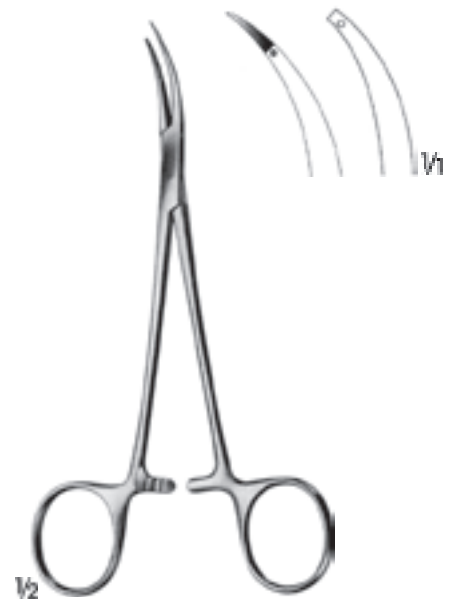

1/2

BE-3302
Tendon geçmeli pens
Tendon interlacing forceps
15 cm





BV-1923 Ø 3 mm
Tendon stripper
Tendon stripper
Şaft uzunluğu
Shaft length 19 cm
Toplam boy
Total length 30 cm



BV-1925 Ø 5 mm
Tendon stripper
Tendon stripper
Şaft uzunluğu
Shaft length 39 cm
Toplam boy
Total length 49.5 cm



REILL
BV-1900 Ø 4 mm
BV-1901 Ø 6 mm
Tendon stripper
Tendon stripper
Şaft uzunluğu
Shaft length 35 cm
Toplam boy
Total length 39.5 cm



ASSMUS
BV-1820 Ø 3 mm
Sinir stripper, Kunt
Nerve stripper, blunt
Şaft uzunluğu
Shaft length 35 cm
Toplam boy
Total length 39.5 cm

BJ-1630 Ø 2.0 mm
BJ-1635 Ø 2.0 mm
BJ-1640 Ø 2.0 mm



BUNNELL
BJ-1623
23 cm



BV-4602
BV-4603
BV-4604
BV-4606

BUNNELL
BV-4602 Ø 2 mm
BV-4603 Ø 3 mm
BV-4604 Ø 4 mm
BV-4606 Ø 6 mm
13.5 cm



BV-4615 Ø 3 mm
BV-4616 Ø 5 mm
30 cm

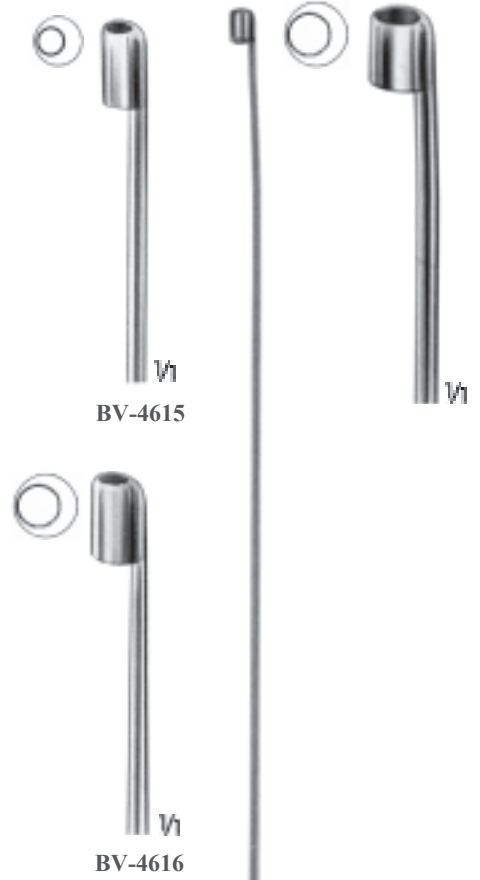

BV-4617 Ø 5 mm
50 cm



BJ-1630 14.5 cm
BJ-1635 16 cm
BJ-1640 20 cm
Gözlü proplar
Probes with eye

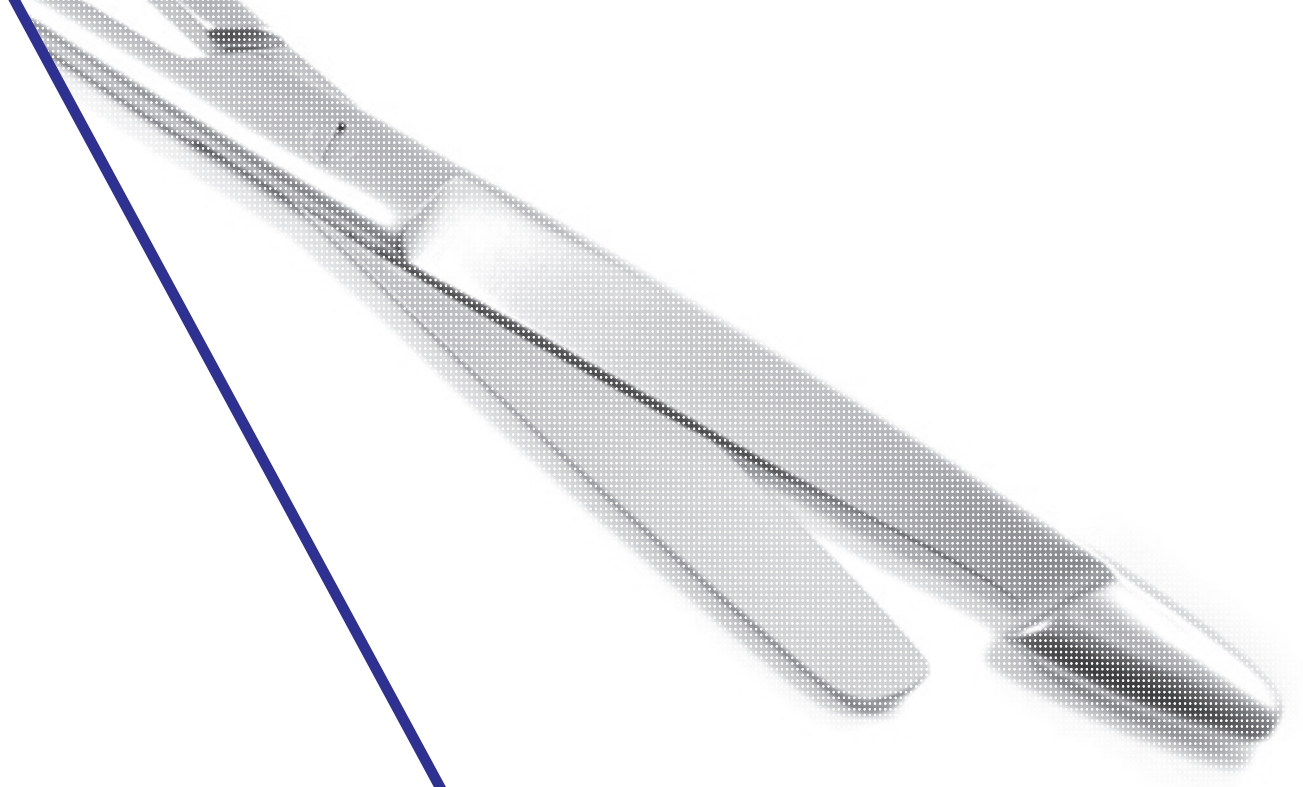

AN

Anatomi, Amputasyon ve Otopsi Aletleri
Instruments for Anatomy, Amputation and Post Mortem





Çift taraflı kesici
Double cutting

Çift taraflı kesici
Double cutting



BB-2155

BB-2160

W1

W2

W2

LANGENBECK
BB-2155 - BB-2160
Rezeksiyon bıçakları
Resection knives
Ağız uzunlukları
Length of blade
5.5 cm

BB-2165
Periyost bıçak
Periosteum knife
Ağız uzunluğu
Length of blade
6.5 cm



W2

BB-2111
Interosseöz bıçak
Interosseous knife
Ağız uzunluğu
Length of blade
11 cm



W2

BB-2120
Falanks bıçak
Phalangeal knife
Ağız uzunluğu
Length of blade
10.5 cm



W2

LANGENBECK
BB-2112
Kanat bıçak
Flap knife
Ağız uzunluğu
Length of blade
12 cm



LISTON
BB-2130 13 cm
BB-2135 16 cm
BB-2140 19 cm
BB-2145 22 cm
Amputasyon bıçak
Amputation knife

Çift taraflı kesici
Double cutting



1/2

**CATLIN
BB-2125**
Ampütasyon bıçak
Amputation knife
Ağız uzunluğu
Length of blade
16 cm



1/2

BB-1925
Ağız uzunluğu
Length of blade
13 cm



1/2

BB-2170
Ağaç sap/Wooden handle
Ağız uzunluğu/Length of blade
17 cm



1/2

BB-2150
Ağız uzunluğu
Legth of blade
19.5 cm

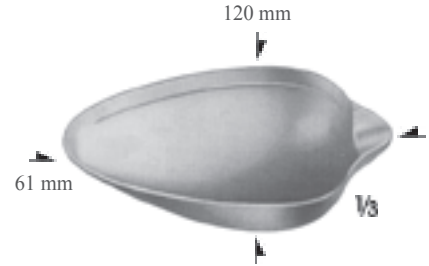

BV-4801
Kan kaşığı/Blood scoop
Hacmi 50 cc/Volume 50 cc



Ø 90 mm

BV-4800
Kan kaşığı
Blood scoops
Hacmi/Volume 50 cc





GIGLI
BV-3730 30 cm
BV-3740 40 cm
BV-3750 50 cm
İki sargılı/Two windings



GIGLI
BV-3830 30 cm
BV-3840 40 cm
BV-3850 50 cm
Üç sargılı/Three winding



GIGLI
BV-3640
Sap/Handle



DE MARTEL
BV-3855 35 cm
Kondüktör için gigli testere teli, esnek
Gigli saw for the flexible conductor wire

LEBSCHÉ
BV-2525
Tel testeresi için klavuz
Conductor for wire saws
Bükülebilir/Malleable
25 cm



LANGENBECK
BV-4123
Metakarpal testeresi
Metacarpal saw
Ağız uzunluğu
Length of blade
11.5 cm
23.5 cm



BV-4120
Bleyd uzunluğu
Length of blade
20 cm



SATTERLEE
BV-4129
29 cm

BV-4118 18 cm
BV-4124 24 cm
Ağız uzunluğu
Length of blade



CHARRIERE
BV-4127 27 cm
BV-4134 34 cm

BV-4220 Komple/Complete
BV-4215, BV-4212, BV-4218

CHARRIERE

BV-4215

Sadece sap/Only handle
35 cm

BV-4212 12 mm

BV-4218 18 mm

Bleyd uzunluđu

Length of blade

21.5 cm

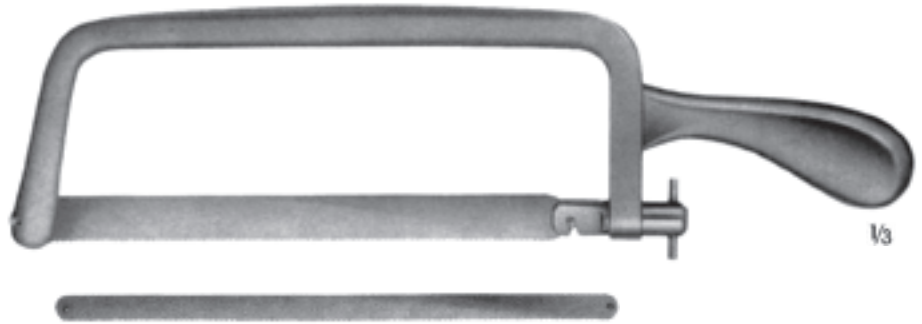

BV-4320 Komple/Complete
BV-4239, BV-4306, BV-4308
(1 adet/1 each)
BV-4312 (2 adet/2 each)

RUST

BV-4239

Sadece sap/Only handle
39 cm

BV-4306 6 mm

BV-4308 8 mm

BV-4312 12 mm

BV-4318 18 mm

Bleyd uzunluđu

Length blade

23.5 cm

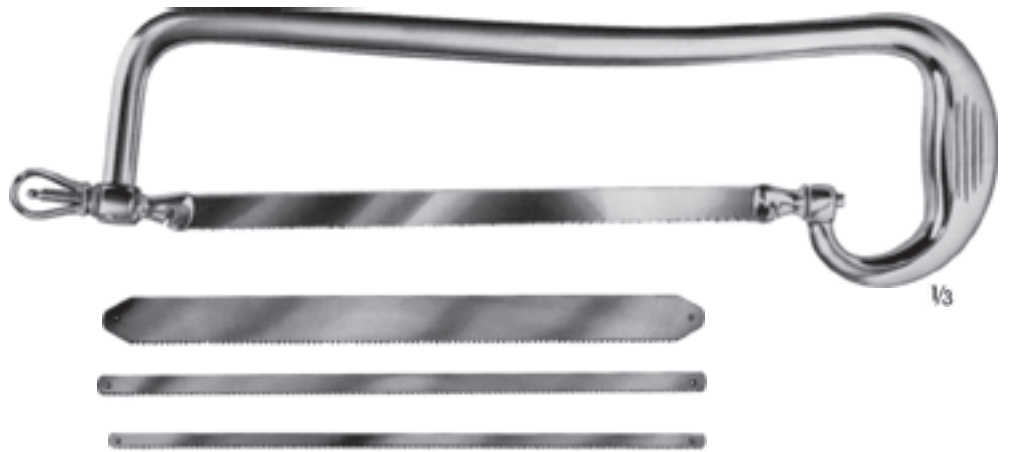

BIER

BV-4210 Komple/Complete
BV-4142, BV-4204, BV-4206
BV-4208

BV-4142

Sadece sap/only handle
42 cm

BV-4204 4 mm

BV-4206 6 mm

BV-4208 8 mm

Bleyd uzunluđu

Length blade

27 cm



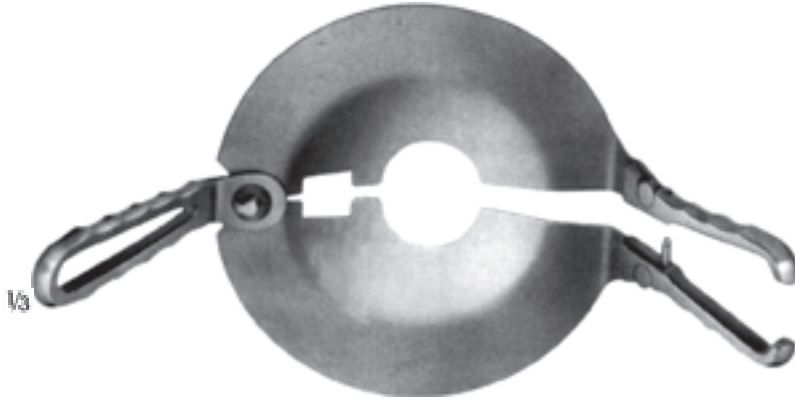

PERCY
BV-4810
Sökülebilir saplı
Removable handles

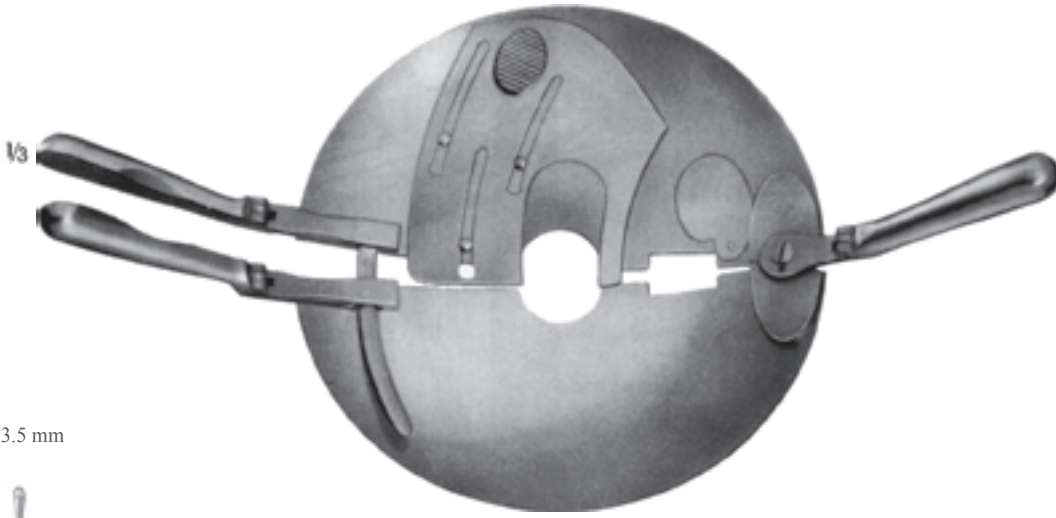

PERCY
BV-4815
Ters çevrilebilir saplı
Reversible handles

Ø 3.5 mm



BJ-1730 30 cm
Çift başlı sonda
bükülebilir, delikli
Double ended probes,
malleable, with hole



BD-2316
16 cm



BD-2318
18 cm



BD-2320
20 cm

BD-2316 - BD-2320
Standart model/Standard pattern
Diseksiyon penseti/Dissecting forceps



BD-5016
16 cm



BD-5018
18 cm



BD-5020
20 cm

STANDARD
BD-5016 - BD-5020
Standart model
Standard pattern



BC-5500
21 cm



BC-5501
21 cm



BC-5391 19.5 cm
BC-5392 22.5 cm



BR-7851 23 cm



SEMB BR-2200
19 cm



FERGUSON BR-2460
20.5 cm



STILLE
BN-6908 8 mm
BN-6910 10 mm
BN-6912 12 mm
BN-6915 15 mm
BN-6920 20 mm
BN-6925 25 mm



BERGMANN BN-9850 245 gr.
23.5 cm



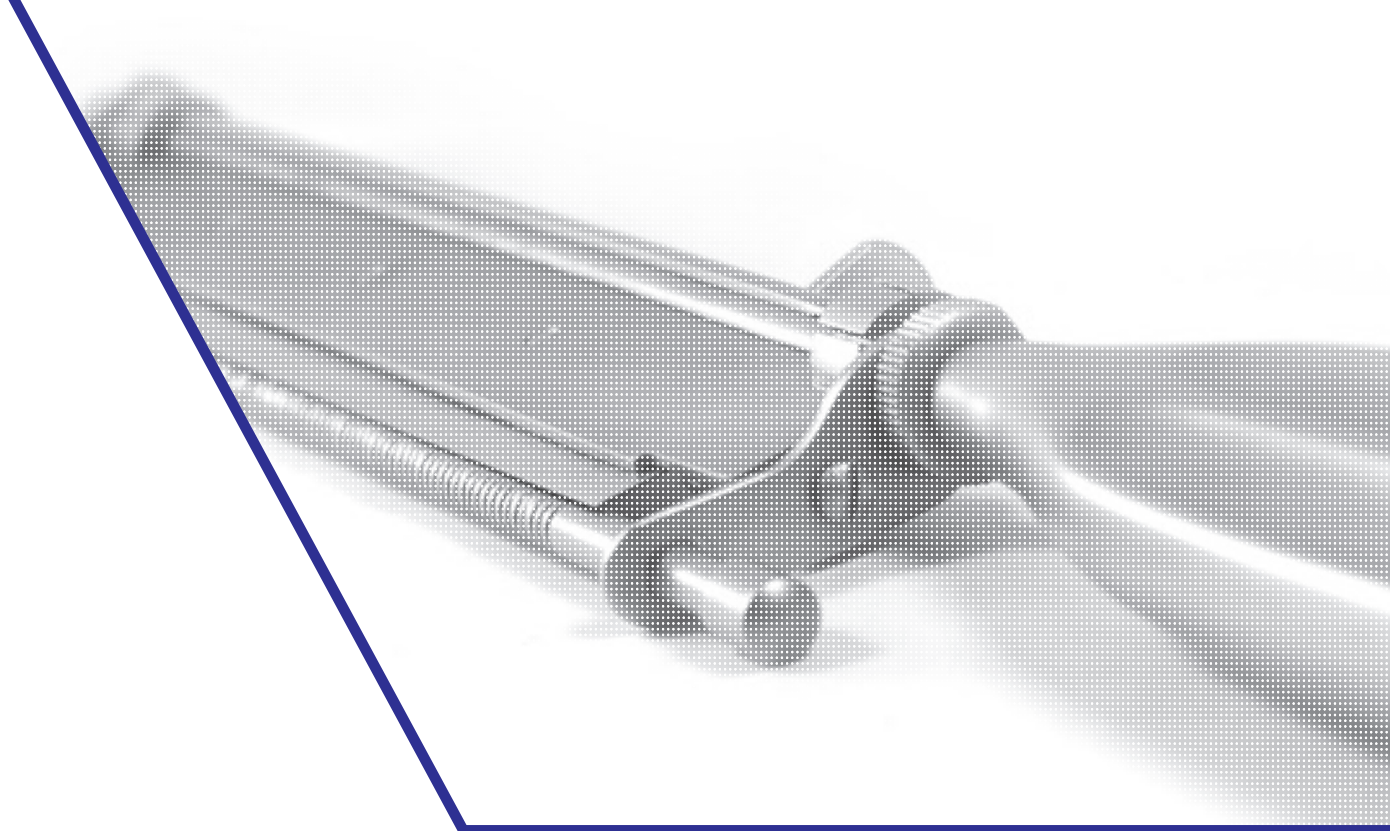

DE

Dermatoloji
Dermatology

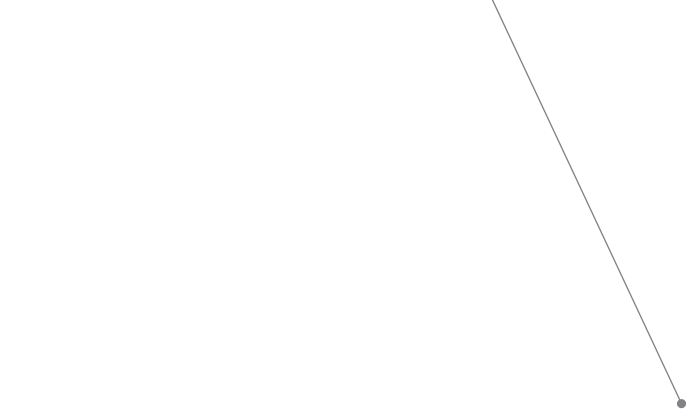



0.2 mm

0.3 mm



BD-1103
11 cm



BD-1106
11 cm



ADSON
BD-4850
12 cm



BD-1820
15.5 cm



CUSHING
BD-1902
20 cm



BD-5301 - BD-5302

BD-5301
14.5 cm



BD-5302
16 cm



V1

-  **BB-2402** Ø 2 mm
-  **BB-2403** Ø 3 mm
-  **BB-2404** Ø 4 mm
-  **BB-2406** Ø 6 mm
-  **BB-2407** Ø 7 mm
-  **V1**

Deri pançları
Dermal punches

KEYES
BB-2402 - BB-2407
10 cm

Ø 2 mm Ø 3 mm Ø 4 mm Ø 6 mm Ø 7 mm



KEYES

BB-2400

5 uçlu, komple deri pançı
Dermal punch, complete with 5
interchangeable tips, handle and
rack

V1



BD-6105
8 cm

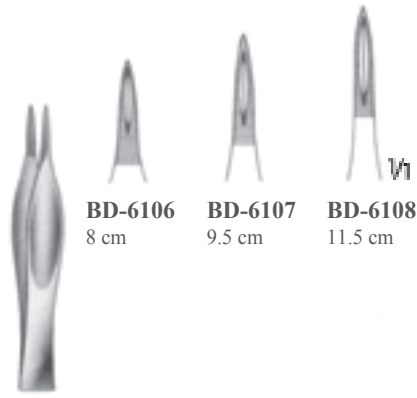

FEILCHENFELD
BD-6106 - BD-6108



HUNTER
BD-6109
10.5 cm



STIEGLITZ
BD-6110
14 cm



STIEGLITZ
BD-6111
14 cm

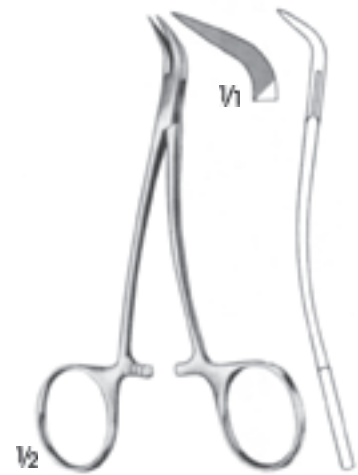

PEET
BD-6112
12 cm





SAALFELD
BB-2500
10 cm

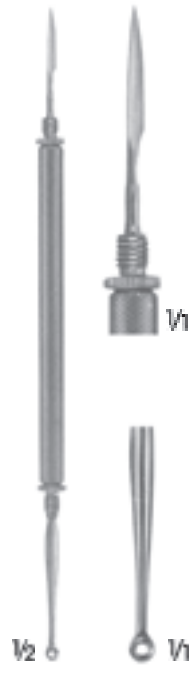

HEBRA
BB-2510
18 cm



BB-2520
14.5 cm



UNNA
BP-2225
14 cm



VIDAL
BN-2116
13.5 cm



KILNER
BK-1363
16 cm



SCHAMBERG
BP-2230
10 cm



FOX
BP-2240 - BP-2243
14 cm



WOLFF
BP-2251 - BP-2256
14 cm

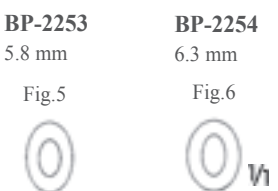
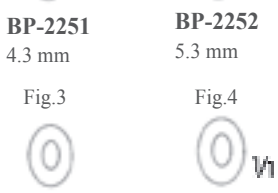
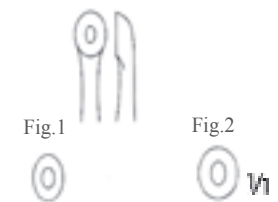
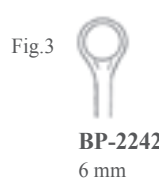



SILVER
BB-2325
Cilt nakil bıçağı, bıçaksız
Skin graft knife, without blade
19 cm



SCHINK
BB-2300
Sadece dermatom
Dermatome only
30 cm

BB-2340
Yedek Bıçak
Spare blade only



BB-2335
Cilt doğrultma plağı
Skin straightening plate
only



WATSON
BB-2310
Cilt nakil bıçağı, bıçaksız
Skin graft knife, without blade
30 cm

Sabit bar
Bar fixed



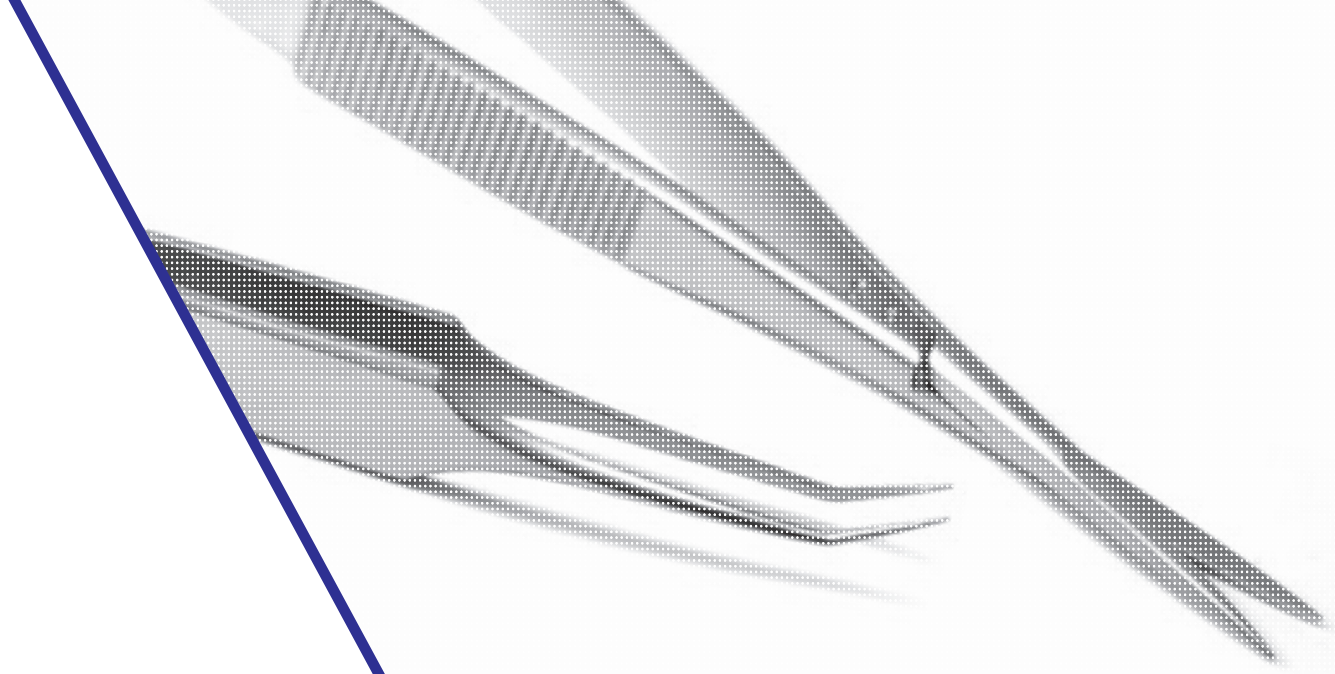

MC

Mikroskopi
Microscopy

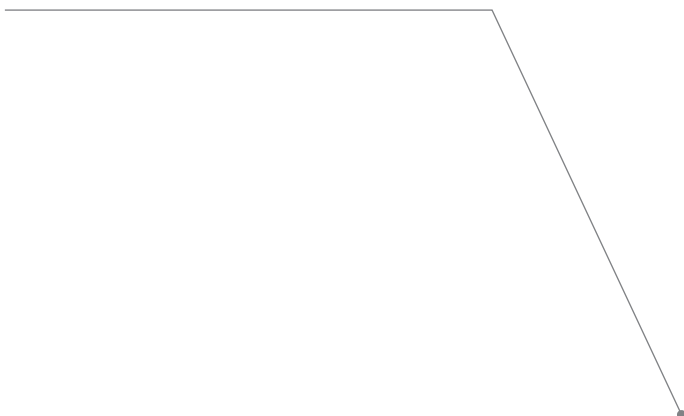



BD-2550
10 cm



BD-2551
10 cm



BD-2552
10 cm

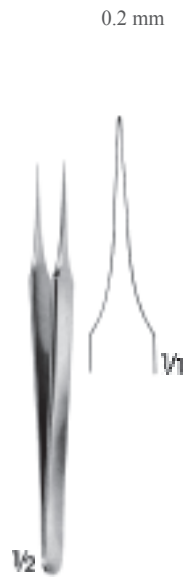

BD-1103
11 cm

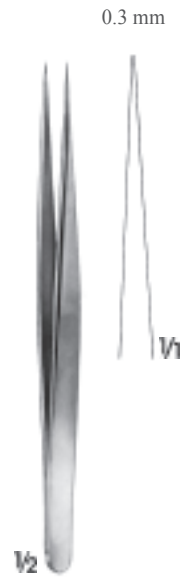

BD-1111
13.5 cm



VANNAS
BC-1130
Düz/Straight
Hassas/Delicate
8.5 cm



BC-1335
Düz/Straight



BC-1340
Eğri/Curved

BC-1335 - BC-1340
Mikro makaslar
Micro scissors
12 cm



REILL
BF-1520 - BF-1521
Kilitsiz/Without catch
15 cm

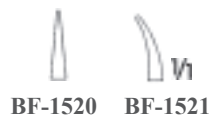

BF-1520 **BF-1521**



BB-2615

Metal saplı,
mikroskopik iğne
Microscopic needle, with
metal handle
13 cm

BB-2620

Metal saplı,
mikroskopik iğne
Microscopic needle with
metal handle
13 cm



MULLER
BM-1100

Fare için ekartör bir çift
Retractors for mouse
pairs

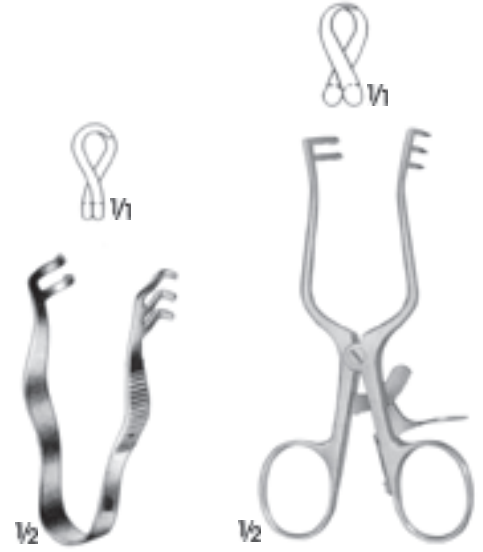

FINSEN
BM-1111

7.5 cm

WEITLANER

BM-1700 Sivri/Sharp
11 cm



BT-1400

Aproksimatör/Approximator

Derin aralıkta mikro damar anastomileri için.
Güvenli ve dikkatli şekilde damar kavrama.
Tırtıklı yüzeyli bleydler.
El ile basınç ayarı yapabilmeye özelliği.
Mesafeyi el ile yakınlştırma ve uzaklaştırma.

For micro vessel anastomosis
Safe and careful gripping of vessel.
Blades with serrated blade surface
The ability to manually set the pressure
Distance, zoom in and out manually



BIEMER

BT-1330

Komple Aproksimatör,
anahtarı ile BT-1340
Approximator, complete
with key BT-1340



BIEMER

BT-1320

Komple Aproksimatör,
anahtarı ile BT-1340
Approximator, complete
with key BT-1340

V1

BT-1340
Anahtar/Key



BIEMER-MÜLLER

BT-1190

Çene uzunluğu/Lenght of jaws.9 mm
Açıklık/Opening 5 mm
Kapanma kuvveti/Closing force 25-30 gr.



V2

BIEMER
BT-1740

Kilitsiz/Without Lock
BIEMER damar klip ve BIEMER-MÜLLER
ve MÜLLER yaklaşıtııcılar için başvuru pensi
Applying forcep for BIEMER vessel clip and
BIEMER-MÜLLER and MÜLLER approximators
14 cm



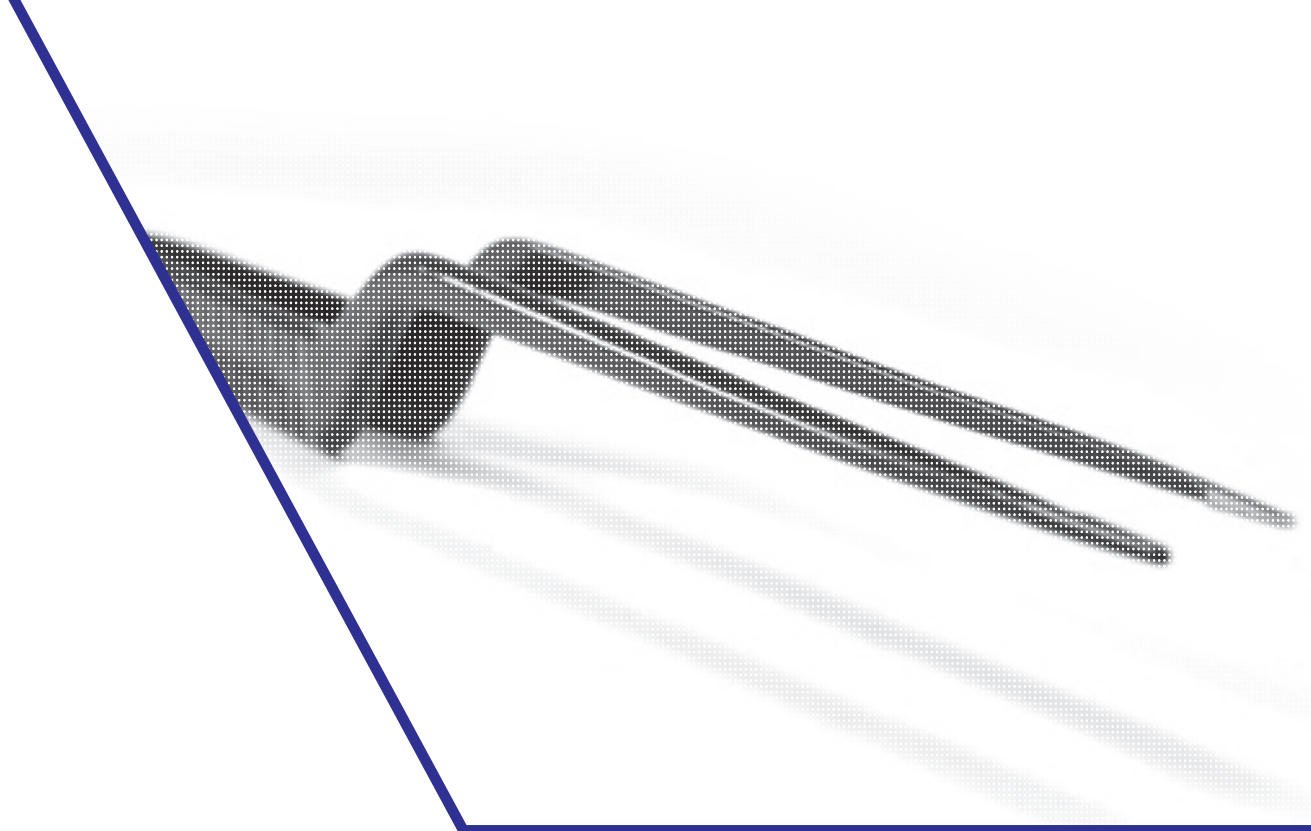

ES

Elektrocerrahi Aletleri
Electrosurgical Instruments

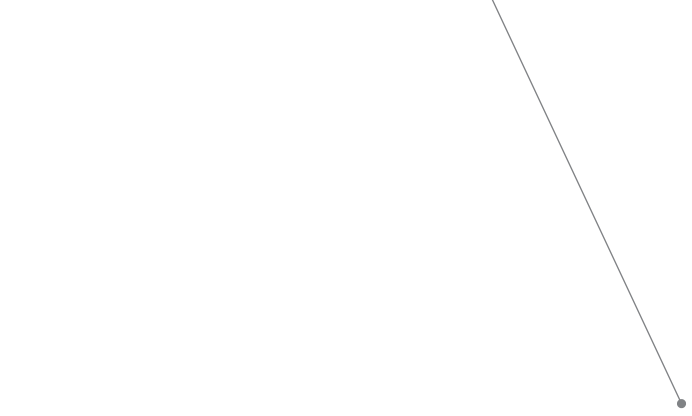



BZ-1256
12 cm



BZ-1255
11 cm



BZ-1103
14.5 cm



BZ-1257
Sivri/Sharp
12.5 cm



BZ-1258
Hassas/Delicate
17.5 cm



BZ-1259
Hassas/Delicate
22 cm



Yapışmaz/Non sticking

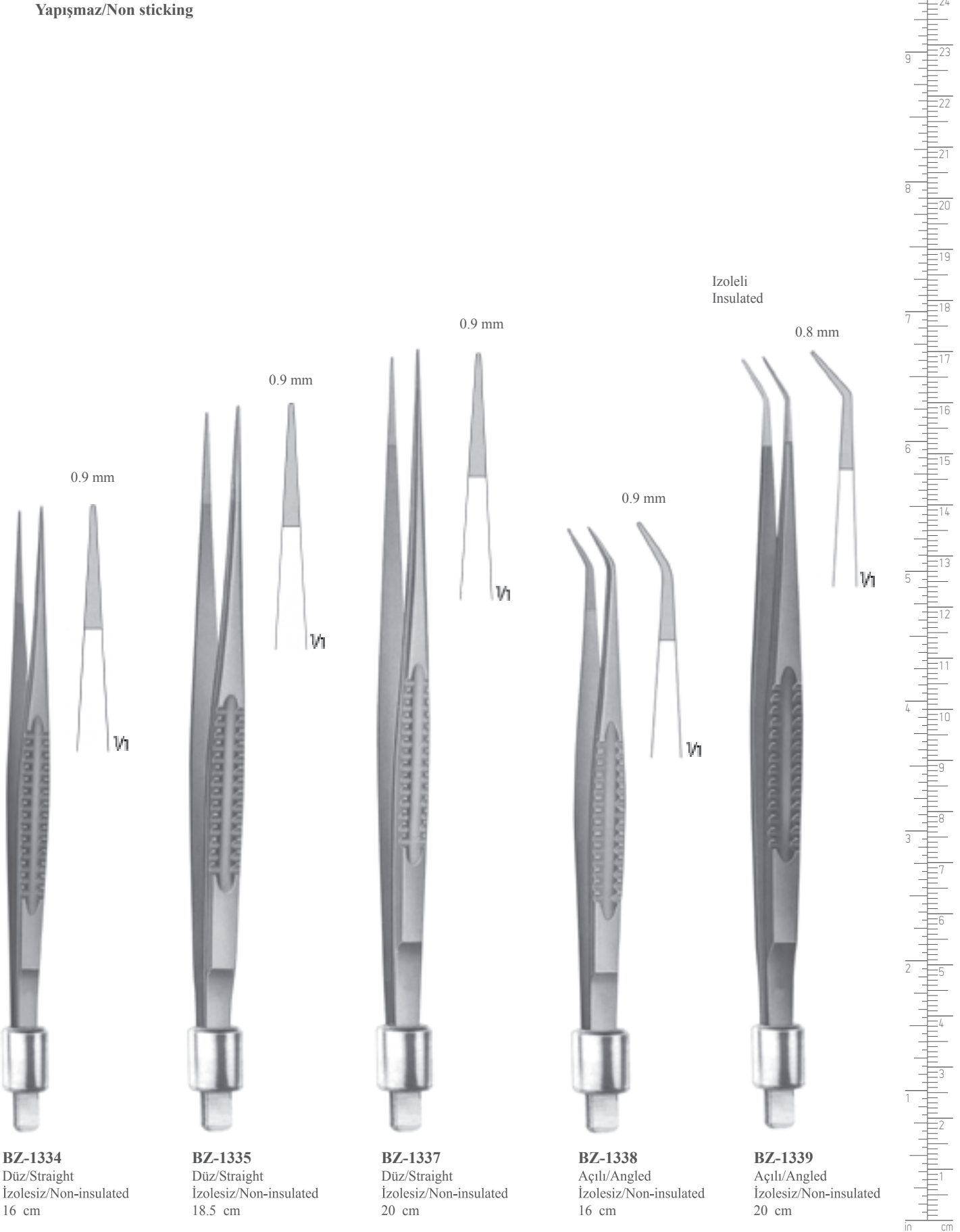

İzoleli
Insulated

İzoleli
Insulated

İzoleli
Insulated

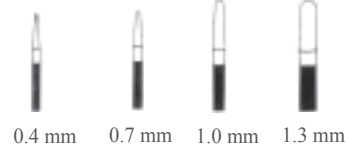

Özellikler

- Doku hazırlanması ve ayırması için uygun.
- Yuvarlak çalışma uçları.
- Dayanıklı izolasyon kaplaması.
- Güvenilir fişli bağlantı.

Features

- Suitable for tissue preparation and spreading.
- Rounded working tips.
- Durable insulation coating.
- Reliable plug-in connection.

BZ-1300 0.6 mm
BZ-1301 0.9 mm
16 cm
BZ-1302 0.9 mm
20 cm

BZ-1304 0.9 mm
20 cm
BZ-1303 0.9 mm
16 cm

BZ-1305 0.4 mm
BZ-1306 0.7 mm
BZ-1307 1.0 mm
BZ-1308 1.3 mm
14 cm
BZ-1309 0.4 mm
BZ-1310 0.7 mm
BZ-1311 1.0 mm
BZ-1312 1.3 mm
15.5 cm

BZ-1313 0.4 mm
BZ-1314 0.7 mm
BZ-1315 1.0 mm
BZ-1316 1.3 mm
17.5 cm
BZ-1317 0.4 mm
BZ-1318 0.7 mm
BZ-1319 1.0 mm
BZ-1320 1.3 mm
19.5 cm

BZ-1321 0.4 mm
BZ-1322 0.7 mm
BZ-1323 1.0 mm
BZ-1324 1.3 mm
21.5 cm
BZ-1325 0.4 mm
BZ-1326 0.7 mm
BZ-1327 1.0 mm
BZ-1328 1.3 mm
23.5 cm

BZ-1329 0.7 mm
25.5 cm

İzoleli
Insulated



0.2 mm 0.5 mm 1.0 mm 2.0 mm

Özellikler

- İnce, hassas, yuvarlak, parlak çalışma
- Dayanıklı izolasyon kaplaması.
- Güvenilir fişli bağlantı.

Features

- Slim, delicate, rounded, polished working tips.
- Durable insulation coating.
- Reliable plug-in connection.

BZ-1353 0.2 mm
BZ-1354 0.5 mm
BZ-1355 1.0 mm
BZ-1356 2.0 mm
16.5 cm
BZ-1357 0.2 mm
BZ-1358 0.5 mm
BZ-1359 1.0 mm
BZ-1360 2.0 mm
19.5 cm

BZ-1361 0.2 mm
BZ-1362 0.5 mm
BZ-1363 1.0 mm
BZ-1364 2.0 mm
22 cm

İzoleli
Insulated



BZ-1365 1.0 mm
16.5 cm
BZ-1366 1.0 mm
19.5 cm
BZ-1367 1.0 mm
22 cm

İzoleli
Insulated



2/3 mm 3/4 mm 4/5 mm

- Halka uçlar
- Dayanıklı izolasyon kaplaması.
- Güvenilir fişli bağlantı.
- Ring tips
- Durable insulation coating.
- Reliable plug-in connection.

BZ-1390 2/3 mm
BZ-1391 3/4 mm
BZ-1392 4/5 mm
19.5 cm
BZ-1393 2/3 mm
BZ-1394 3/4 mm
BZ-1395 4/5 mm
23.5 cm





Yapışmaz/Non sticking

İzolesiz
Non-insulated



BZ-1342 0.7 mm
16 cm
BZ-1343 1.0 mm
18.5 cm
BZ-1344 1.0 mm
20 cm

İzolesiz
Non-insulated



BZ-1350 1.0 mm
21 cm

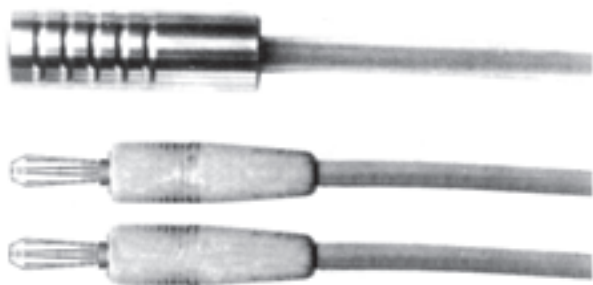

BZ-1102
Bipolar kordon
Bipolar cord
2 mt.

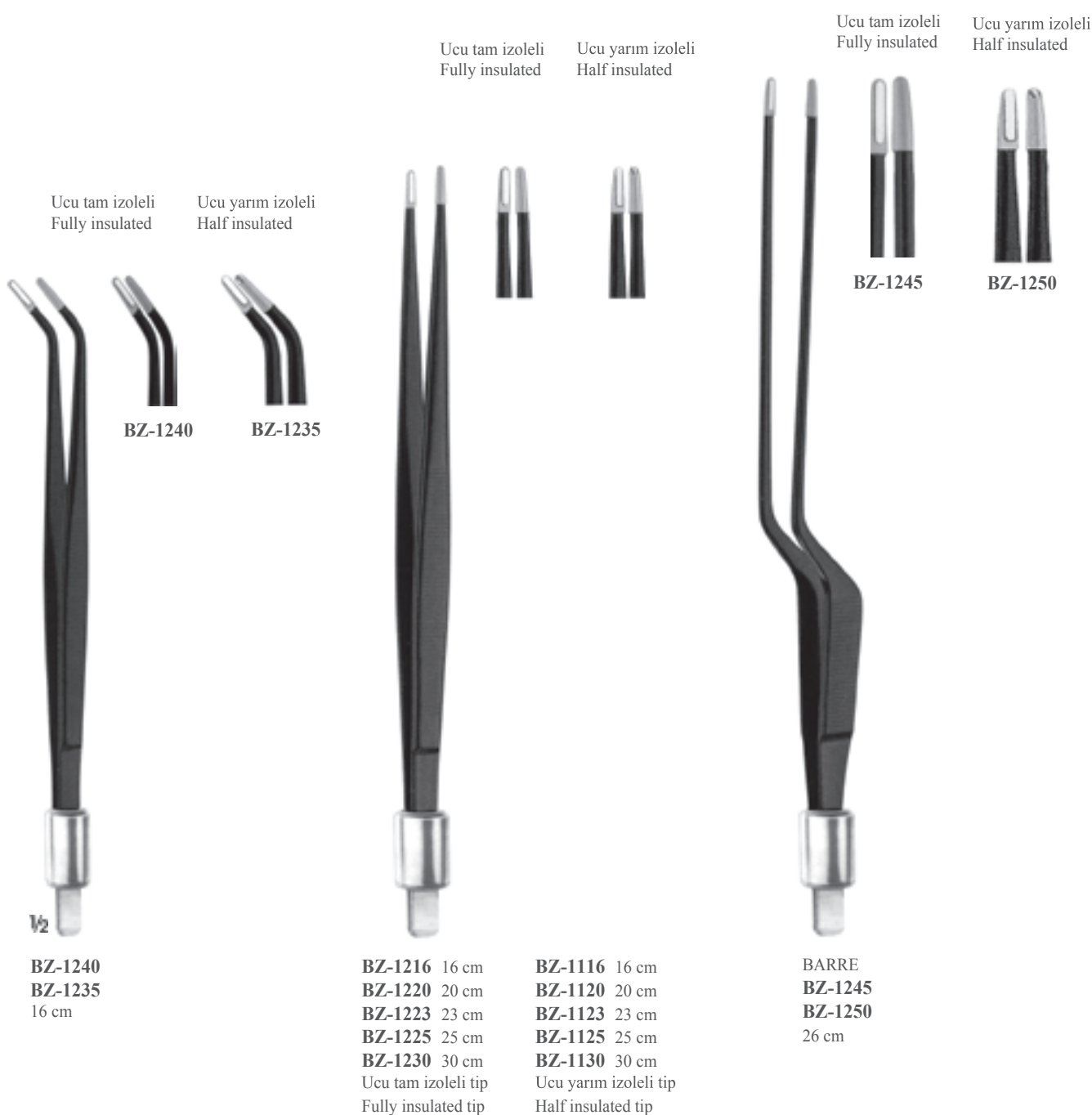

Ucu tam izoleli
Fully insulated

Ucu yarım izoleli
Half insulated

Ucu tam izoleli
Fully insulated

Ucu yarım izoleli
Half insulated

Ucu tam izoleli
Fully insulated

Ucu yarım izoleli
Half insulated

BZ-1240

BZ-1235

BZ-1245

BZ-1250

W₂

BZ-1240
BZ-1235
16 cm

BZ-1216 16 cm
BZ-1220 20 cm
BZ-1223 23 cm
BZ-1225 25 cm
BZ-1230 30 cm
Ucu tam izoleli tip
Fully insulated tip

BZ-1116 16 cm
BZ-1120 20 cm
BZ-1123 23 cm
BZ-1125 25 cm
BZ-1130 30 cm
Ucu yarım izoleli tip
Half insulated tip

BARRE
BZ-1245
BZ-1250
26 cm





BW

Taslar, Böbrek Tasları, Sterilize Pensleri
Bowls, Kidney Trays, Sterilizing Forceps

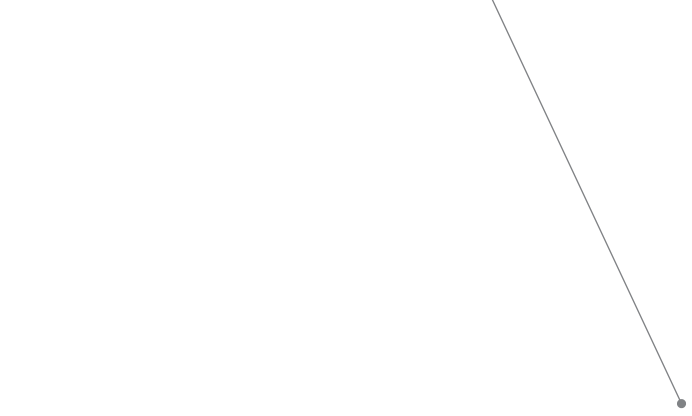



CN-8131
0.05 LT.



CN-8132
0.1 LT.



CN-8133
0.25 LT.



CN-8126 0.02 LT.
4.0 x 2.8 x 1.9 cm
CN-8127 0.06 LT.
6.1 x 4.2 x 3.0 cm
CN-8128 0.16 LT.
8.3 x 5.4 x 4.1 cm
CN-8120 0.4 LT.
11.1 x 7.2 x 5.6 cm
CN-8121 1.0 LT.
15.1 x 10.0 x 7.3 cm
CN-8122 2.5 LT.
21.1 x 14.5 x 9.6 cm



CN-8129
175 x 100 x 35 mm
CN-8130
205 x 115 x 40 mm
CN-8123
255 x 145 x 40 mm
CN-8124
275 x 155 x 45 mm



CN-8134
1.0 LT.



1/3

CHEATTLE
BE-4300
28 cm



BE-4503 20 cm
BE-4504 30 cm



1/2

ROGGE
BE-4505
23.5 cm

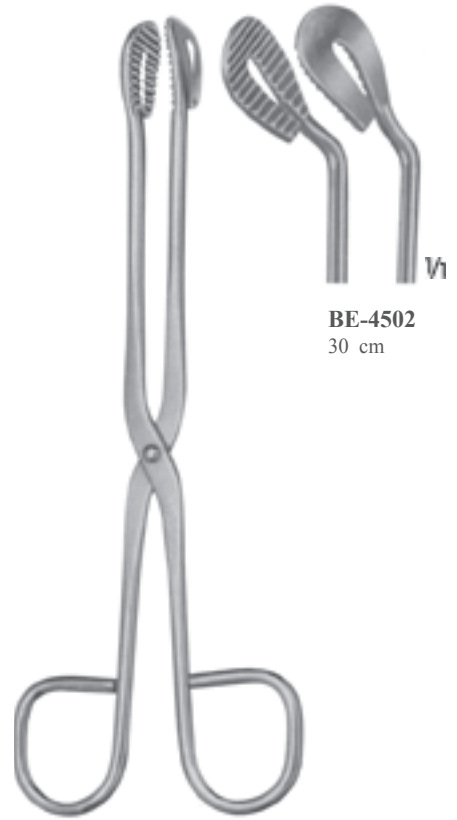

BE-4502
30 cm



*Steril Konteyner Sistemleri için web sitemizi ziyaret ediniz.
Please visit our website for **Sterile Container Systems**.*

www.aseltech.com.tr



A-Z

TÜRKÇE ALFABETİK İNDEKS
TURKISH ALPHABETICAL INDEX



A			
ABBEY, mukuza iğne	863	AUSTIN, mikro sütür bağlama pensi	99
Abdominal makaslar	62	AUVARD, vajinal spekulumlar	523
ABEL, uterin tenekulum pensi	536	Ayna	758
ABRAHAM, tonsil bıçağı	17	Ayna sapları	6, 58
Açı ölçer	7	B	
ADAIR, uterin tenekulum pensi	534	BABCOCK, organ ve doku tutma pensleri	148, 149
ADLERKREUTZ, damar ve tümör pensetleri	120	BABY-CRILE-WOOD, HARDMODEL portegü	177
ADSON, aspiratör uçları	306	BABY-ADSON, diseksiyon ve dikiş pensleri	235
bayonet penset	112	BABY, ALLIS, doku tutma pensleri	146
doku penseti	114	BABY-COLLIN batın ekartörler	420
elektrocerrahi aletleri	854	BABY-CRILE, hassas hemostatik pensler	219
HARDMODEL diseksiyon pensleri	124	BABY-KOCHER, bağırsak klempleri	439
hassas diseksiyon pensleri	102	BABY-METZENBAUM, diseksiyon makasları	50
hassas doku pensetleri	115	HARDMODEL diseksiyon makası	94
hassas doku pensetleri, Titanyum	129	HARDMODEL diseksiyon makasları	85
hassas hemostatik pensler	222	HARDMODEL diseksiyon makasları, PerfectCut	90
hassas pensetler	114, 838	Supercut diseksiyon makasları, PerfectCut	92
kemik pançı	748	BABY-MIKULICZ, periton pensi	246
kemik ronjuru	712	BABY-MIXTER, diseksiyon ve dikiş pensleri	235
otomatik ekartörler	399	BABY-OVERHOLT, diseksiyon ve dikiş pensleri	235
otomatik laminektomi ekartörler	403, 405	BABY-ROUX, ekartör	336
perforatör	747	BABY-SENN-MILLER, ekartörler	332
portegü	172	BACKHAUS, çamaşır klempleri	156
raspalar	621, 624	BACKHAUS-KOCHER, çamaşır klemp	156
sinir ve damar hukları	320	Bağırsak makası	59
ADSON-BABY, otomatik ekartörler	399	Bağırsak ve kıkırdak makasları	835
ADSON-BROWN, dişli doku penseti	115	BAILEY, göğüs ekartörleri	608
Ağırıklar	798	BAINBRIDGE, bağırsak klempleri	438
Ağız açıcılar	3	BAKES, dilatörler	480
Alçı ayırıcılar	797	BALFOUR, batın ekartörleri	424, 425
Alçı kesme makası	75, 794	BALFOUR-BABY, batın ekartör	423
Alçı ve kumaş makası	76, 795	BALLANTINE, otomatik ekartör	410
Alet tablası	774	BANE-HARTMANN, kemik ronjuru	711
ALEXANDER, gujlar	657	BARNES-NEVILLE, doğum pensi	570
kemik ronjuru	710	BARPE, damar ve beyin cerrahi makası	70, 498
raspa	597, 626	BARRAQUER, mikro portegüleri	163
ALLEN, bağırsak klemp	438	otomatik ekartör	394
osteofit keski ve raspa	621	BARRE, bipolar penset	499
ALLENBERG, ATROMATİK hemostatik pensler	276	bistüri sapları	22
buldog klemp	605	diseksiyon ve dikiş pensleri	241, 498
iliak ekartörler	431	BARRON, aspiratör uçları	308
otomatik ekartörler	401	hemoroid ligatür konik yükleyici	470
penset	431	hemoroid ligatür mili	470
ALLIS, arter tutma pensi	146	hemoroid ligatür sapı	470
ATROMATİK organ pensleri	147, 459	hemoroid ligatürü	470
organ ve doku tutma pensleri	147, 148	BARSKY, ince yara ekartörü	324
ALLIS THOMS, organ ve doku tutma pensi	148	BART, kemik küreti	676
ALLISON, ciğer spatulaları	363	Batın ekartörleri	420-422
ALLPORT, otomatik ekartör	395	Batın ekartörü (zincir ve ağırlık)	388
ALM, otomatik ekartörler	395	Batın ekartörü, ağırlık	388, 524
Alyan T kol	817	Batın ekartör, zincirli	388
Amputasyon testere bleydi	832	Batın ve bağırsak malaları	390, 750
Amputasyon testeresi	832	BAUMGARTNER, HARDMODEL portegü	177
Ampütasyon bıçakları	831	HARDMODEL tel bükücü	182, 802
Anahtarlar	662, 671, 746, 812, 813, 845	portegü	170
ANGEL, tel kesme pensi	805	Bayonet pensetler	112
Antrum pançı	778	BEACHAM, amniyotom	565
Aort pançlar	604	Bebek tırnak makası	4, 78
Aproksimatör	211, 845	BECK, ronjur	736
ASCH, kaşık küreti	502, 550	BECKMANN-ADSON, otomatik laminektomi ekartörler	404
Aspiratör kanülleri	313	BECKMANN-EATON, otomatik laminektomi ekartörü	405
Aspiratör sapı	313	BEEBE, tel kesme makasları	79
Aspiratör uçları	307, 309-313	BEHRMAN, uterin kanülleri	562, 563
ASSMUS, sonda	755, 826	BELLUCCI, aspiratör uçları	308
ATROMATİK bronş pensler	284, 452	BENGOLEA, hassas hemostatik pensler	224
buldog klempler	216	BENNETT, özel kemik elevatörler	645
hemostatik pensler	260	BENSAUDE, anoskoplar	465
koarktasyon klempleri	295	BENSON, mide klemp	450
organ ve doku tutma pensleri	143, 473, 543	BERGER, biyopsi pensleri	553
ultra hafif pensetler	108	BERGMANN, alçı kesme makası	75, 794
AUFRICHT, kemik törpüsü ve raspaları	690		

bıçak	14	kılavuz sondaları	200
çekiç	672, 673, 835	ligatür iğneleri	200, 810
yara ve soluk borusu ekartörü	325	sigmoid anastomoz pensi	452
BERKELEY-BONNEY , histerektomi hemostatik pens	251	sütür aleti, ligatür iğnesi	199
BERLIN , biyopsi küret	550	BRUNS , alçı makası	76, 795
BERNHARD , uterin tenekulum pensi	156, 534	kemik küretleri	678, 682
BERRY , HARDMODEL tel bükücü	182, 802	BRÜNINGS , biyopsi pens kanülleri	555
BETHUNE , göğüs makası	609	dil basacağı	2
BEYER , kemik ronjurlar	711, 713	ronjurlar	733
Beyin kaşıkları	750, 751	BRYANT , spanç ve pansuman pensi	134
Beyin şantları	748	BUCHWALD , dil basacağı	2
Bıçaklar	14, 15	BUCK , pamuk aplikatörü	302
BIEMER , aproksimatör	211, 845	BUCK-GRAMCKO , kemik elevatörleri	636
damar klipsler	210, 847	BUELAU , trokarlar	316
damar klipsleri için penset	210	Buldog klempler	215, 605
mikro damar klipsleri	208	BUMM , plasenta ve ovum küretleri	559
proksimatörler	211, 845	uterin kaşıklar	558
sinir ve damar huku	754	BUNNELL , el matkabı	813
BIEMER-MÜLLER , aproksimatörler	209, 845	tendon stripperler	827
BIER , amputasyon testere	833	BUNT , alet askısı	159
amputasyon testere bleydleri	833	BURKE , histerektomi pensleri	255, 549
amputasyon testere sapı	833	BUSHE , kemik küretleri	680
BIRCHER-GANSKE , menisküs pensleri	818	BÜCHS , ekartör	355
BIRKETT , hassas hemostatik pensleri	223	raspa	624
BISHOP-HARMON , hassas göz penseti	114	Bükme kolları	816
Bistüri sapları	22-24, 499, 546	Bükme ve kıvrıma aparatı	816
Bistüri sapı, mikrocerrahi bıçaklar için	767		
Biyopsi pens sapı	468, 555	C	
Biyopsi pensi	468, 469, 554	CAIRNS , dura ekartör	322
BLAKE , safra taşı pensleri	482, 602	hassas hemostatik pensleri	219, 220
uterin küret	560	CAIRNS, DOTT , hassas diseksiyon pensetleri	105
Bleyd tutma pensi	416	CAIRNS , elevator	634
Bleyd tutucu	417, 790, 791	CAMPBELL , sinir ve sinir kökü ekartörü	334
BLOUNT , ekartör	350, 819	CANNY-RYALL , ekartörler	338
özel kemik elevatörü	647	CARREL , hassas hemostatik pens	218
BLUMENTHAL , kemik ronjurları	709	CARTER , raspa	616
BOER , plasenta ve ovum pensi	575	CASPAR , bistüri sapı	24
BONNER MODELL , mikro sütür bağlama pensi	99	disektör	615, 760
BONNEY , diseksiyon penseti	107	düğüm aparatı	204, 755
doku penseti	122	ekartör	355
polipus ve ovum pensi	545	iticiler	669
BOROWSKI , aort kapağı ekartörleri	595	kemik küretleri	686, 687
BOSE , otomatik ekartör	394	mikro bıçaklar	767
yara ve soluk borusu ekartörleri	325	mikro disektörler	760
BOWMAN , sondalar	302	otomatik ekartörler	413-416
BOZEMANN , rahim makası	61	raspalar	615, 623, 759
uterin pansuman pensleri	532, 533	ronjurlar	738, 741, 743
vajinal spekulumlar	524	sinir ve damar hukları	321, 757
BOZEMANN-DOUGLAS , uterin pansuman pensi	533	sinir ve sinir kökü ekartörleri	334, 416
Böbrek taşları	864	CASTANEDA , ATROMATİK anastomoz ve çok amaçlı klempler	263
BÖHLER , kemik kesme pensleri	719	CASTROVIEJO , göz makasları	29
kemik ronjurları	713	HARDMODEL mikro portegüler	164
Bölücü için sürgülü raylar	527	hassas göz penseti	114
BRAITHWAITE , cilt nakil bıçağı, kesicisiz	21	mikro portegüler	162
BRAND , tendon tutucu pensler	145	CATLIN , amputasyon bıçağı	18, 831
BRAUN , organ ve doku tutma pensi	151, 539	CAWTHORNE , pamuk aplikatörü	302
uterin bastırıcı	531	Cement çıkartıcılar	823
uterin tenekulum pensi	534	Cement iticiler	822
vajinal spekulumlar	518	Cerrahi makaslar	41-44
BRAUN-STADLER , bandaj makası	73	Cetveller	7
epizyotomi makasları	73, 567, 606	CHADWICK , hassas makas	39
BREISKY , vajinal spekulumlar	516, 520	CHAMPIONNIERE , kemik matkabı	811
BRIDGE , hassas hemostatik pensler	225	CHANDLER , kemik elevatörleri	628
BRISTOW , kemik elevatörü	635	CHAPUT , arter tutma pensi	146
BROCK , mikro sütür pensetler	101	CHARNLEY , doku penseti	122
BRODIE , sonda	300, 472	CHARRIERE , amputasyon testere bleydleri	832, 833
BROM , sinir ve damar huku	320	amputasyon testere sapı	833
BROPHY , doku penseti	118	amputasyon testereleleri	832
hassas diseksiyon pensetler	104	CHEATLE , sterilizasyon pensi	159, 857
BROWN , hassas doku pensetleri	115	CHERON , spanç ve pansuman pensi	139
BRUNNER , ekartörler	365, 367, 368, 386	CINELLI , osteotomları	659
göğüs makası	609		



CITELLI, paçlar	722	osteotomlar	657, 779
Cilt doğultma plağı	20, 841	raspalar	619, 623
CLAUS VAN EICKEN, sütür aleti ligatür iğneleri	199	COTTLE-KNAP, plastik cerrahi makaslar	50
CLOWARD, anahtar	789	COTTLE-MASING, plastik cerrahi makası	47
çakma başlığı	789	CRAFOORD, hassas hemostatic pensler	225
çekiciler	670, 788	CRAIG, ronjurlar	732
derinlik ölçer	789	CRAIG-DOMNICK, ronjur	732
ekartörler	418, 786, 788	CRILE, ekartör	335
ekartör bleydleri	418, 786	hassas hemostatik pensler	220, 221
elevatörler	788	portegü	175
greft alma kolu	789	sinir ve damar huku	320
greft alma matkapları	789	CRILE-MURRAY, portegü	171
greft tutma uçları	789	CRILE-WOOD, HARDMODEL portegüler	178
kol içi çapı	789	portegüler	171
koruyucu klavuzları	789	CRUCHFIELD, kafa traksiyon aletleri	746
koter huku	788	CUSCO, vajinal spekulumlar	509, 510
lamina ayırıcılar	419, 787	CUSHING, doku penseti	118
matkap kolları	789	HARDMODEL diseksiyon penseti	125
matkap koruma başlığı	789	hassas diseksiyon pensetler	104, 838
matkap koruyucular	789	hassas diseksiyon pensetler, Titanyum	130
matkap uçları	789	perforatörler	747
merkezleme pimleri	789	ronjurlar	737, 739
osteotom	788	sinir ve damar hukları	320
tutma kolları	789	yara ve damar ekartörler	331
COBB, gujlar	668	CUSHING-KOCHER, yara ve damar ekartörü	331
raspalar	628, 629	CUSHING-LANDOLT, hipofizektomi spekulumları	779
COBBETT, cilt nakil bıçağı	21	CZERNY, doku ve organ tutma pensi	151, 540
COBRA, kemik elevatörleri	645	ekartör	339
COCK, rektal spekulum	464	rektal spekulum	462
COLLER, hassas hemostatik pensler	221	safra taşı pensi	482
COLLIN, bağırsak tutma pensleri	150		
batın ekartörler	420, 422	Ç	
böbrek alma pensi	491, 545	Çamaşır klempleri	155, 157, 158
dil pensleri	8, 41, 141	Çamaşır pensleri	159, 857
ekartör	335	Çekiçler	670, 671, 673, 823
göbek kordonu klemp	567	Çekiç, yedek diskler	671
klip çıkarıcı pens	204		
organ ve doku tutma pensleri	143	D	
spanç ve pansuman pensi	139	DAHLGREN, dura koruyucu	749
uterin çıkartma pensleri	544, 545	huk	749
uterin küret	560	Damar makasları	29, 70, 477
vajinal spekulumlar	508	Damar ve beyin cerrahi makasları	69
COLLIN-HARTMANN, ekartör	339	DANDY, hassas hemostatik pensler	220
COLLIN-POZZI, uterin tenekulum pensi	534	DARDIK, ATROMATİK çok amaçlı klempler	285
CONE, laminektomi ekartör	401	DARLING, otomatik laminektomi ekartörler	407
CONVERSE, HARDMODEL portegü	177	DARTIGUES, böbrek alma pensi	491, 544
ince yara ekartörü	324	DAUBENSPECK, kemik küretileri	680
portegü	170	DAVIDSON, kürek ekartörler	366
COOLEY, atrium ekartörler	592-594	DAVIS, disektör	596, 614
ATROMATİK anastomoz ve çok amaçlı klempler	264, 265, 292	raspa	614
ATROMATİK anastomoz klempler	288, 290, 293	DE BAKEY, arteriyotomi makası	49
ATROMATİK aort klemp	297	aspiratör kanülleri	314, 607
ATROMATİK buldog klempler	286, 287	ATROMATİK anastomoz çok amaçlı klempler	264
ATROMATİK çok amaçlı klempler	289, 296	ATROMATİK diseksiyon ve ligatür pensler	282
ATROMATİK koarktasyon klempler	294	ATROMATİK sigmoid anastomoz pensi	273, 454
ATROMATİK pensetler	108	ATROMATİK tanjensiyel oklüzyon klempler	268
damar ve beyin cerrahi makası	70	ATROMATİK aort anastomoz klemp	280
hassas diseksiyon penseti	105	ATROMATİK aort anevrizma klempler	274-276
sternum ekartörler	587	ATROMATİK aort klemp	278
COOLEY-BECK, ATROMATİK anastomoz klempler	288	ATROMATİK buldog klempler	217, 262
COOPER, cerrahi makaslar	42	ATROMATİK çok amaçlı klempler	272
sütür aleti, ligatür iğnesi	199	ATROMATİK duktus klempler	269
CORYLLOS, ciğer spatulaları	364	ATROMATİK koarktasyon klempler	271
COTTLE, bayonet penset	112	ATROMATİK mikro pensetler	108
burun spekulumları	778	ATROMATİK pensetler	108, 109, 459
çekiciler	672, 779	ATROMATİK pensetler, Titanyum	131
diseksiyon makası	46	ATROMATİK periferik damar klempler	269, 270
dura ekartör	323	ATROMATİK ultra hafif penset	131
ekartörler	329, 330	damar dilatörleri	600, 601
ince yara ekartörü	322	göğüs ekartörleri	583, 585
keski	657	HARDMODEL damar makası	84, 477
keski ve osteotom	657		

HARDMODEL portegüler	178, 179	myoma burguları	546
kalça kemiği ekartörü	408	portegü	171
kardiyovasküler makaslar	67, 68	raspalar	598, 632
sternum ayırıcılar	586	sonda	300
TİYANYUM ultra hafif penset	131	vajinal spekulumlar	522
DE BAKEY-BAINBRIDGE, ATROMATİK hemostatik pens	260	yanal spekulumlar	522
DE BAKEY-BECK, ATROMATİK vena kava klemp	267	DUBOIS, rahim makasları	64
DE BAKEY-HARKEN, ATROMATİK vena kava klemp	267	DUNHILL, hassas hemostatik pensler	218, 223
DE BAKEY-HESS, buldog klemp	214	DUPLAY, spanç ve pansuman pensleri	135
DE BAKEY-KELLY, ATROMATİK hemostatik pens	260	uterin tenekulum pensi	536
DE BAKEY-MC QUIGG-MIXTER, ATROMATİK bronş klemp	281	Dura ekartör	323, 757
DE BAKEY-MIXTER, ATROMATİK diseksiyon ligatür pens	283	Dura ve cilt ekartörü	324, 757
DE BAKEY-PEAN, ATROMATİK hemostatik pensler	261	DURHAM, ekartör	352
DE BAKEY-RUMEL, ATROMATİK diseksiyon ligatür pensler	283	DUVAL, bağırsak penseti	122
DE BAKEY-SATINSKY, ATROMATİK tanjensiyel oklüzyon klemp	268	bağırsak tutma pensi	150
DE LEE, pelvimetre	564	DUVAL, COLLIN, organ ve doku tutma pensleri	149
DE MARTEL, kondüktör	749	Düğüm aparatı	204
DE MARTEL-WOLFSON, anastomoz klemp	450		
kapama pensi	450	E	
DE VILBISS, dura koruyucu	749	EAST GRINSTEAD (WARD), keskiiler	658
DEAVER, cerrahi makaslar	45	EAST GRINSTEAD, osteotomlar	658
ekartörler	369-374	EASTMAN, keskiiler	658
Delikli tepsiler	528	vajinal spekulum	518
Delme başlıkları	812	ECHLIN, kemik ronjurları	714
DEMEL, tel kılavuzları	800	Ekartörler	329, 346, 351, 365, 649-655, 845
tel bükme pensi	801	Ekartör tutucu mil	771, 773
DENIS-BROWNE, bağırsak penset	122	Ekartör yerleştirme kolu	414
batın ekartörler	428	Ekartörler, esnek kol	774
DERF, HARDMODEL portegü	177	Ekartör, masa bağlantı mafsalları	771, 773
portegü	170	Ekartör, pens tutucu	773
Derinlik ölçerler	814	Ekartör, tutma ve sabitleme elemanları	770, 774
DERRA, ATROMATİK anastomoz ve çok amaçlı klemp	265	El matkabı	813
DERRA, COOLEY, ATROMATİK anastomoz klemp	289	El sabitleyicileri	824
DESCHAMPS, sütür aletleri, ligatür iğnesi	194-197	El vanası ve bağlantı borusu	561
DESJARDINS, diseksiyon ve dikiş pensi	244, 476	Elektrocerrahi aletleri	848-855
safranalı sondaları	478	Elektrotlar	856-862
safrataşı kaşıkları	479	Elektrot kabloları	863
safrataşı pensleri	483	Elektrot konteyneri	858, 859
DESMARRES, ekartörler	330	Elektrot rakları	858
DETHRICH, kardiyovasküler makasları	67	Elektrot tutucusu	863
DIAPOWDER mikro pensetler	125, 126, 127	Elevatör	634
DIAPOWDER mikro pensetler, Titanyum	128	EMMET, ekartör	330
DIAPOWDER mikro portegüler	165, 166, 168, 169	spanç ve pansuman pensi	139
DIAPOWDER mikro portegüler, Titanyum	167	Endarterektomi temizleyiciler	603
DICK, ATROMATİK anastomoz klemp	256, 284, 451	ENGEL, alçı testeresi	795
DIEFFENBACH, buldog klemp	214	ENGIL MOD, çamaşır klemp	155
DIETHRICH, ATROMATİK aort klemp	277	Enjeksiyon iğnesi	564
buldog klemp	215	Epizyotomi makası	73, 567
DINGMANN, kemik tutma pensleri	699	EPPENDORE, biyopsi pensleri	553
DITTEL, üretral dilatasyon bujiler	504	EPSTEIN, kemik küreleri	681
DIXON-LOVELACE, hassas hemostatik pensler	222	ESMARCH, alçı bıçağı	795
Dil basacakları	2, 4	alçı kesme makasları	75, 794
Dilatör	754		
Dilatörler için steril saklama parçaları	527	F	
Diseksiyon makasları	46	FAHLBUSCH, mikro kaşık	783
Diseksiyon pensetleri	106, 107, 834, 836	mikro küret	783
Diseksiyon pensetleri, Titanyum	130	Falanks bıçak	19, 830
Diseksiyon ve dikiş pensleri	235, 236	FARABEUF, ekartörler	335
Diseksiyon sinir makası	49	kemik tutma pensleri	701
Diseksiyon ve şaşılık makasları	34	raspalar	626
Diseksiyon, sinir makası	35	FARABEUF-COLLIN, raspalar	626
Disektör	615	FARABEUF-LAMBOTTE, kemik tutma pensi	701
Distraktör	698, 799	FARRELL, pamuk aplikatörleri	303, 304
Diz ekartörleri	350, 351, 819	FAURE, biyopsi pensleri	551
DOCKHORN, ekartörler	355	periton ve histerektomi pensleri	247
Doku pensetleri	116-119, 834, 838	FAVOLORO, kardiyovasküler makası	68
Doku pensetleri, Titanyum	129	FEILCHENFELD, kıymık pensetler	123, 839
DOUNAY, biyopsi pens	554	Femur ekartörü	644
DOYEN, bağırsak klemp	438-441	FERGUSSON, aspiratör uçları	305
batın ekartörler	380, 382, 387, 388, 519	baskı klemp	474
çamaşır klemp	155	kemik tutma pensi	700, 835
hemoroid pensi	474, 543		



FERGUSON-ACKLAND, ağız açıcı	3
FERRIS-SMITH, HARDMODEL diseksiyon penseti	125
FICKLING, çekiç	670
hemostatik pensler	232
FINECHIETTO, diseksiyon ve dikiş pensi	244
göğüs ekartörleri	580-583
torasik ekartörler	591
HARDMODEL portegü	186
FINOCHIETTO-BURFORD, göğüs ekartörleri	584
FINSEN, otomatik ekartörler	394, 395, 845
FINSTERER, sulama kanülü	315, 607
FISCH, dura ve cilt huku	324, 757
Fiber ışık taşıyıcı NAUNTON, MORGAN için	466
Fistül bıçakları	16
Fistül sonda	472
FOERSTER BALLANGER, tampon pansuman pensi	140, 474
FOMON, diseksiyon makasları	47
ekartör	329
kemik törpüsü ve raspaları	691
osteotomlar	659
FORMBY, aspiratör ucu	307
Forseps	823
FOWLER, tonsil bıçak	17
FOX, küretler	840
FÖRSTNER, pozisyon pensi	697
FRASER-KELLY(CRILE), hassas hemostatik pens	223
FRAZIER, aspiratör uçları	305
dura ekartör	322
raspa	617
FREER, guj	656
ince yara ekartörü	322
keskiler	656
raspalar	596, 614, 616, 617
FREER-YASARGIL, raspa	614
FRENZEL, dil basacağı	2
FRIEDMANN, kemik ronjurları	708
FRITSCH, batin ekartörler	383
FRYKHOLM, kemik ronjuru	714
FUCHSIG, hassas hemostatik pens	222
FUKUSHIMA DESING, aspiratör uçları	309

G	
GABRIEL, rektal spekulum	466
GALABINS, uterin sonda	531
GALLAHER, kemik törpüsü ve raspası	691
GARDNER, WELLS, kafa traksiyon aleti	746
GELPI, cilt ve vajinal ekartör	408, 525
vajinal ekartör	408, 525
GEMINI, diseksiyon ve dikiş pensleri	238
GERALD, doku pensetler	118
hassas diseksiyon pensetler	104
mikro pensetler	101
GERSTER, kemik klempi	707
GIERTZ-STILLE, göğüs makası	609
GIGLI, tel testereleler	749, 810, 832
tel testere sapı	749, 810, 832
GILLES, portegüler	174
aspiratör ucu	307
doku penseti	119
HARDMODEL portegü	181
hassas diseksiyon penseti	104
ince yara ekartörleri	323
osteotomlar	659
elektrocerrahi aletleri	854
GILSBACH, kombine ekartörler	772
kombine ekartör, bağlantı elemanları	773
kombine ekartör, yarım daire bar	772
kombine ekartör, çerçeve	772
kombine ekartör, el dayama barı	773
kombine ekartör, tutucu mil	772
ekartör sistemi	772-774

Gland ve sünnet pensi	500
GLASSER, DIAPOWDER mikro portegüler	166
GLOVER, ATROMATİK anastomoz klempier	266
ATROMATİK buldog klempier	217
GLUCK, göğüs makası	609
GOELET, ekartör	337
GOLIGHER, batin ekartör	426
GORNEY, aspiratör disektör	311
diseksiyon makasları	51
Supercut diseksiyon makası	93
GOSLEE, tel tutma pensi	803, 815
GOSSET, batin ekartörler	423, 424
GOURET, kemik küretleri	556, 688
Göbek dilatörü	567
Göbek kordonu makasları	72, 566
Göğüs makası	609, 835
GRAEFE, cilt ekartörleri	322
diseksiyon makası	46
hassas doku penseti	115
sinir ve damar hukları	320
GRAVE, vajinal spekulumlar	510
GRAY, diseksiyon ve dikiş pensler	244, 475
GREEN-ARMYTAGE, sezeryan hemostatik pensler	571
GREENE, ekartör	352
GREGORY, ATROMATİK profunda klempier	282
GREY-TURNER, hassas hemostatik pens	223
GROSS, pansuman pensler	9, 135
spanç pensler	9, 135
spanç ve pansuman pensler	134
GRUENWALD bayonet penset	112
diseksiyon penseti	125
Gujlar	656, 664, 666-668, 817, 822
GULEKE, kemik ronjuru	712
GUTHRIE, cilt ekartörleri	322
GUYON, böbrek klempier	486-488
katater için uygulayıcı	504
katater kılavuz	504
üretal dilatasyon bujileri	505
GWILLIAM, histerektomi hemostatik pensler	251

H	
HAASE, itici	669
pozisyon pensleri	696, 697
HABERER, batin ve bağırsak malası	391
mide, bağırsak pensi	449
HAIGHT, göğüs ekartörü	581
HAJEK, çekiç	670
ekartör	338
sulama kanülü	478
HAJEK-KOFER, pançlar	723
HAKANSSON, kemik ronjuru	709
HALLE, elevatör	596, 615
kemik küretleri	680
HALSEY, HARDMODEL portegüler	176, 177
portegüler	170
HALSTED, hassas hemostatik pensler	222
HALSTED-MOSQUITO, hassas hemostatik pensler	218, 223
diseksiyon makası	94
diseksiyon makasları, PerfectCut	95
transfenoidal spekulum	778
HARDMODEL cerrahi makaslar	80, 81
HARDMODEL cerrahi makas, PerfectCut	89
HARDMODEL diseksiyon makaslar	85
HARDMODEL diseksiyon makası, PerfectCut	90
HARDMODEL diseksiyon pensetler	124, 125
HARDMODEL hassas ligatür makaslar	80
HARDMODEL hassas makaslar	80
HARDMODEL histerektomi makaslar	84
HARDMODEL kemik törpüleri ve raspaları	692, 693
HARDMODEL ligatür makaslar,	88, 89
HARDMODEL makaslı portegü	181



JOSEPH, cilt ekartörleri	323	kılavuz sondası	203
çift taraflı burun bıçakları	16	traksiyon aletleri	799
Supercut diseksiyon makasları	93	Kıymık penseti	123, 839
hassas makaslar	34, 38	KLAPP, yara ve damar ekartörü	333
kemik törpüsü ve raspaları	690	Kılavuz sondaları	203
raspa	621	KLEINERT-KUTZ, ince yara ekartörleri	323
el festeresi	825	tendon geçiş pensisi	145
JUDD-ALLIS, organ ve doku tutma pensisi	148	KLEINSCHMIDT, apendektomi klempisi	450
		Klemp tutucular	450
K		KLIMA-ROSEGGER, trokar	316
KADER, batin ve bağırsak malası	390	KLINIKUM BERLIN, Tüp klempisi	11
Kalça ekartörü	821	KLINKENBERG, damar cerrahi makası	71
KALLMORGEN, vajinal spekulumlar	516	Klip aplikatörleri	768
Kan kaşıkları	391, 831	Klip aplikatörleri, Titanyum	769
KANTROWITZ, diseksiyon ve dikiş pensleri	241	Klip aplikatör pensleri	578, 579, 752
Kanüller	315, 561	KNOWLES, bandaj ve kumaş makasları	74
Katater kılavuz	504	KOCHER, bağırsak klempeleri	440, 442, 443
Kavrama silikonları	655	basacak	391
KAZANJIAN, kemik kesme pensisi	718	ekartörler	342, 348, 356
KEIBACK, diseksiyon ve dikiş pensleri	245, 547	hemostatik pensler	230
KELLY, anoskop	465	kemik ekartörleri	340
batın ekartörleri	379	kılavuz sondaları	202
ekartörler	353	mesane ekartörü	495
hassas hemostatik pensler	219	sütür aleti, ligatür iğnesi	199
hassas makaslar	38	yara ve damar ekartörleri	333
organ ve doku tutma pensleri	142, 542, 574	KOCHER-LANGENBECK, ekartörler	345
proktoskop	466	KOCHER-OCHSNER, hemostatik pensler	231
rektal spekulumlar	464	KOCHER-WAGNER, ekartörler	358
sfinteroskop	465	KOFLER, pauç	724
Kemik biyopsi trapanları	812	KOGAN, endo spekulumlar	529
Kemik ekartörü	340	Komedon ekstraktör	840
Kemik elevatörleri	636-638, 640, 641, 644, 646	KONIG, elevatörler	634
Kemik kesme pensleri	718, 719	Konik uçlu delme boruları	605
Kemik küretleri	676, 677, 679, 680, 689	KOOS, mikro damar bıçakları	764
Kemik makasları	835	KÖNIG, raspa	620
Kemik pauç	748	yara ve damar ekartörleri	331
Kemik ronjurları	708, 709	kılavuz sondaları	201
Kemik tablaları	814	KÖRTE, ekartör	342, 343, 376
Kemik törpüsü ve raspaları	690, 691, 693	KÖRTE-WAGNER, ekartör	342
Kemik tutma pensleri	700, 705, 706	KRAMER, ekartör	355
KERN-LANE, kemik tutma pensleri	702, 703	keski	658
KERN-MINI, kemik tutma pensisi	703	raspalar	624
KERPEL, kemik küretleri	683	ronjurlar	740, 743
KERRISON, kemik pauçları	726, 727	KRAUSE, biyopsi pens uçları	555
kemik pauçları	726-729	trokar	316
pauçları	722, 725	KRAYENBULH, sinir ve damar hukları	321, 756
KERSTING, ATROMATİK sigmoid anastomoz pensisi	455	KRISTELLER, vajinal spekulumlar	512-515, 517
Kesim uçları, biyopsi pensisi için	468, 469, 555	KRONECKER, sütür aletleri, ligatür iğnesi	194
Keski	652, 656, 662, 663, 665	KRONLEIN, hemostatik pens	226
KEVORKIAN, biyopsi pens	554	Kumaş makası	76
KEY, raspalar	629	Kumpaslar	7
KEYES, deri pauçları	838	KUNTSCHER, oyucular	820
KIEBACK, ATROMATİK histerektomi pensleri	253	KÜMMEL, ekartör	376
parametriyum makasları	60, 548	KÜSTNER, uterin tenekulum pensisi	538
KIELLAND, doğum pensisi	569		
Kıkırdak makası	51	L	
Kılavuzlar	815	LA GRANGE, hassas makas	40
Kılavuz kılıfı	564	LABORDE, tiroid dilatörler	409
Kılavuz pimleri	815	LAHEY, ekartör	351
KILLIAN, kemik makası	77	organ ve doku tutma pensleri	151, 539
raspalar	615, 617	LAHEY(SWEET), diseksiyon ve dikiş pensleri	245, 476
rektal spekulum	462	LAHGENCBEK, HARDMODEL portegüler	189
sonda	302	LAMBERT-KAY, ATROMATİK aort anastomoz klempeleri	280
KILNER, diseksiyon makasları	47	LAMBOTTE, kemik tutma pensleri	706
ekartörler	332, 337	osteotomlar	659, 662
HARDMODEL portegü	177	raspalar	597, 626
hassas diseksiyon makası	46	LANCASTER, otomatik ekartör	394
ince yara ekartörleri	322, 324, 840	LANDAU, trokar	316
portegü	171	vajinal spekulumlar	520
KING'S COLLEGE HOSPITAL, pamuk aplikatörleri	302	LANDOLT, aspiratör ucu	310
KIRSCH, ekartörler	349	ayırıcı	779
KIRSCHNER, batin ekartörler	429	bistüri sapı	25

disektörler	781	Ligatür kılavuzları	756
enuklasyon makası	47	Ligatür makası	78
huk	781	LLOYD-DAVIES (GOLIGHER'S) rektal makas	58, 457
kanül	315, 863	LLOYD-DAVIES, biyopsi pensi	468
kaşık	781	LLOYD-DAVIS, sigmoid anastomoz pensi	453
küret	781	LOCKHART-MUMMERY, sondalar	300, 472
raspa	623	LOCKLIN, hassas makas	40
ronjur	740	LOCKWOOD, bağırsak tutma pensi	150
LANDOLT-REULEN, disektör	782	LOGAN-REILL, otomatik ekartör	394
huk	783	LOPEZ-REINKE, aspirasyonlu tonsil disektör	311
raspalar	783	LORNA, çamaşır klempeleri	158
LONDON, vajinal spekulum	518	LOUTE, tel gerici	801
LANE, çamaşır klempi	155	LOVE, sinir ve sinir kökü ekartörleri	334
doku pensetleri	120	LOVE-GRUENWALD, ronjurlar	739
ekartörler	338	LOWER, diseksiyon ve dikiş pensi	245
kemik elevatörü	635	LOWMAN, kemik klempeleri	707
kemik tutma pensler	702, 703	LOWMAN-GERSTER, kemik klempi	707
mide, bağırsak pensleri	448	LOWMAN-HOGLUND, kemik klempi	707
LANE-TRETHOWAN, kemik elevatörü	635	LUC, ronjurlar	733, 734
LANG-STEVENSON, bağırsak klempi	446	LUCAE, bayonet pensetler	112
LANGE, ekartör	330	LUCAS, gujlar	658
LANGE-HOHMANN, kemik elevatörleri	642	kemik küretler	677
LANGENBECK, ekartörler	344, 346	keskiler	658
elevatörler	634, 635	LUER, ekartör	335
kanat bıçak	18, 830	hemoroid pensler	473
kemik tutma pensi	700	kemik ronjurları	709, 711
metakarpal testeresi	832	LUER-FRIEDMANN, kemik ronjuru	709
raspalar	597, 625	LUER-KÖRTE, safra taşı kaşıkları	479
rezeksiyon bıçakları	19, 830	LUER-STILLE, kemik ronjurları	715, 716
LANGENBECK-GREEN, ekartörler	329	Lumbar mikro disektomi küretleri	685
Laringel aynalar	1, 6, 58		
LATHBURY-FARRELL, pamuk aplikatörleri	302-304	M	
LAWRENCE, diseksiyon ve dikiş pensi	243	MAC DONALD, disektör	616
portegü	170	MAGILL, aspiratör uçları	312
LAZAR, mikro sütür bağlama pensleri	99	dil pensi	8
LEBSCHE, sternum keskişi	606	MAIER, spanç ve pansuman pensleri	136
tel testere için kondüktör	832	MAINGOT, histerektomi ve hemostatik pensler	249
LEECH-WILKINSON, biyopsi pens	554	MALTZ, kemik törpüsü ve raspası	690
uterin kanüller	562	Mamaria ekartör	588
LEES, ATROMATİK bronş klempeleri	281	MANNERFELT, ekartör, üçgen saplı	327, 328
LEGUEU, mesane spatula	495, 430	guj	658
LEITZ, ATROMATİK anastomoz klemp	291	osteotomlar	658
LEKSELL, kemik ronjurları	714	raspalar	622
LEKSELL-STILLE, kemik ronjuru	715	MARQUARD, kemik ronjuru	713
LELAND-JONES, ATROMATİK periferik damar klempeleri	270	MARTIN, ekartör	360, 521
LEMBERT, kemik ronjuru	708	pelvimetre	564
aspiratör uçları	307	MARTINI, kemik küretleri	676
kemik küretleri	680	MASING, ekartör	330
kemik ronjurları	710	HARDMODEL portegü	176
raspalar	621	kıkırdak kesme bıçağı	16
LERICHE, ekartörler	375	osteotomlar	659
hassas hemostatik pensler	220	MASSON, HARDMODEL portegü	184
LEWIN, kemik klempi	698	porgetü	173
LEWIS, kemik törpüsü ve raspalar	690	MASSON-LUETHY, portegü	173
LEWKOWITZ, plasenta ve ovum pensleri	575	MATHEU, yabancı cisim pensi	502
LEXER, diseksiyon makaslar	55	ekartör	339
HARDMODEL diseksiyon makası	82	HARDMODEL portegüler	190
HARDMODEL diseksiyon makası, PerfectCut	89	portegüler	175
gujlar	663, 664	rektal spekulum	463
osteotomlar	663	vajinal spekulumlar	518
LEXER-MINI, gujlar	663	MATHIEU-STILLE, portegüler	175
osteotomlar	663	Matkap kılavuzları	817
LICHTENBERG, HARDMODEL portegü	190	Matkap kolları	817
LINDEMANN, el testeresi	825	Matkap T kol	817
LISTER, bandaj ve kumaş makasları	74, 75	MAYFIELD, kafa dayanakları	777
burun pensleri	134	kafa dayanağı uzatma çubukları	777
LISTON, ampütasyon bıçağı	18, 830	kafa klempi	776
kemik kesme pensleri	718, 720	kemik ronjuru	713
LISTON-KEY-HORSLEY, kemik kesme pensi	610, 721	masa bağlantı aparatları	776
LISTON-STILLE, kemik kesme pensi	610, 721	MAYNIHAN, bağırsak klempi	445
LITTLER, diseksiyon makası	46	safra taşı sondası	478
LITTLEWOOD, uterin tenekulum pensi	538		



MAYO, alet askıları	159	MILLS, kardiyovasküler makası	68, 477
cerrahi ve diseksiyon makasları	56	MINI-FINOCHIETTO, torasik ekartör	591
diseksiyon makasları	53, 55, 82	MISKIMON, otomatik laminektomi ekartör	403
HARDMODEL diseksiyon makasları	81, 82	MITCHELLS, raspa	626
HARDMODEL diseksiyon makası, PerfectCut	89	MIXTER, diseksiyon ve dikiş pensleri	243, 245, 475
safra kanalı sondası	478, 530	MIXTER-O'SHAUGHNESSY, diseksiyon ve dikiş pensi	240
Supercut diseksiyon makasları,	93	Mikro damar makasları	66
MAYO-ADAMS, otomatik ekartör	400	Mikro disektörler	596, 761, 762
MAYO-HARRINGTON, diseksiyon makasları	55	Mikro halka penset	101
MAYO-HEGAR, HARDMODEL portegüler	180	Mikro huklar	762
portegüler	171, 172	Mikro kepeçler	762
MAYO-LEXER, diseksiyon makasları	54	Mikro ligatür makası	31
diseksiyon makasları	94	Mikro makaslar	28, 30-32, 98, 101, 838, 844
diseksiyon makasları, PerfectCut	95	Mikro pensetler, titanyum	128
HARDMODEL diseksiyon makası	81, 82	Mikro portegüler	162, 163
HARDMODEL diseksiyon makası, PerfectCut	89	Mikro raspa	762
MAYO-NOBLE, diseksiyon makasları	54	Mikro sütür bağlama pensetleri	99, 101
MAYO-ROBSON, bağırsak klempleri	444	Mikroskopik iğneler	845
MAYO-STILLE, cerrahi ve diseksiyon makaslar	56	Mini oyucu	815
diseksiyon makaslar	53	Mini vida tutucu	815
MC CLINTOCK, plasenta ve ovum pensi	574	MOLLISON, otomatik ekartörler	397, 400
MC CLURE, mikro makas	28	MOLT, raspa	620
MC GIVNEY, hemoroid pensi	470	MORE, protez çıkarıcı	821
MC INDOE, doku penseti	119	MORRIS, ATROMATİK sigmoid anastomoz pensi	273, 454
dura ve cilt hukları	324	ekartörler	356
hassas diseksiyon penseti	105	sternum ayırıcılar	586
kemik kesme pensi	719	MOYNIHAN, hassas hemostatik pens	219
MC KENTY, raspa	620	hemostatik pensler	232, 475
MC KENZIE, klip aplikatörleri	752, 753	MUHLING, kemik makası	77
perforatör	747	MUNCHEN, biyopsi küret	550
MC KISSOCK, raspa	625	MURPHY, ekartörler	344
MEAD, çekiç	671	MURPHY-LANE, luksasyon elevatörü	647
çekiç, yedek disk	671	MUSEUX, organ ve doku pensi	151, 539
kemik ronjuru	709	uterin tenekulum pensleri	537, 538
raspa	620	MÜHLING, raspalar	623
MEHDORN, damar klipsleri	208, 210	MÜLLER, aproksimatörler	209
Meme markörleri	7	ATROMATİK rektal anastomoz klemp	456
Menisküs pensi	818	ATROMATİK damar klipsleri	213
MERBURG MODELL, tel bükücü	803	damar klipsleri, travmatik olmayan	212
Metel kataterler	503	ekartörler	385, 497
METZAMBAUM, elektrocerrahi makasları	855	HARDMODEL portegü	185, 459
diseksiyon makasları	35, 50, 52	ince yara ekartörleri	322
diseksiyon makaslar	94	ligatür pensi	212
diseksiyon makası, PerfectCut	95	mikro makaslar	33
HARDMODEL diseksiyon makaslar	85-87	mikro pensetler	100
HARDMODEL diseksiyon makasları, PerfectCut	90, 91	mikro portegüler	162
Supercut diseksiyon makasları,	92	rektal makas	59, 458
METZENBAUM-NELSON, HARDMODEL diseksiyon makası	87		
MEYER, pozisyon pensleri	697	N	
MEYERDING, ekartörler	332, 357	NABATOFF, varis aletleri	599
otomatik ekartörler	406	NAGELE, doğum pensi	568
otomatik laminektomi ekartörler	407	NAUNTON MORGAN, HARDMODEL portegü	185
MICHEL, klip uygulayıcı penset	204	spekulumlar	466
klip uygulayıcı, çıkarıcı pensetler	204	NEGUS, aspiratör disektör	311
rinoskopik aynalar	6	hemostatik pensler	234
MICRO-ADSON, hassas diseksiyon pensetler	102, 128	NELATON, sonda	300
hassas doku penseti, Titanyum	129	NELSON, akciğer tutma penseti	122
hassas pensetler	114	NELSON-METZENBAUM, diseksiyon makasları	52
MICRO-ADSON, BEIMER, hassas penset	114	HARDMODEL diseksiyon makasları	86
MICRO-HALSTED, hassas hemostatik pensler	218	HARDMODEL diseksiyon makasları, PerfectCut	91
MIDDELDORPF, ekartörler	352	NELSON-METZENBAUM(MC INDOE), HARDMODEL diseksiyon makasları	86
MIKRO-ADSON, diseksiyon ve dikiş pensleri	235	NICOLA, küretler	785
MIKULICZ, batin ekartörler	378, 379, 387	raspa	782
hemostatik pens	234	NIEDERDELLMANN, osteotomlar	662
periton pensleri	246	NISSEN, diseksiyon ve dikiş pensi	244, 475
periton ve histerektomi pensleri	247	hassas hemostatik pens	222
MILLER, kemik törpüsü ve raspaları	691	NOON, ATROMATİK bulldog klemp	262
MILLESİ, mikro makaslar	30	NORFLOK AND NORWICH, otomatik laminektomi ekartörler	403
MILLIGAN, raspa	617	NORTHBENT, ligatür makası	78
MILLIN, ligatür tutucu pens	192, 496	NORTHFIELD, kemik ronjuru	712
mesane ayırıcı	495	NOTO, organ ve doku tutma pensi	142, 542
mesane ekartörleri	494, 430	NOVAK, SCHOECKAERT, biyopsi küret	550

NOYES, göz makası	29	raspa	621
NUSSBAUM, bağırsak klempleri	445	ronjur	736
O		sonda disektör	614
O'CONNELL, disektör	617	PERCY, amputasyon ekartörleri	834
O'SHAUGHNESSY, diseksiyon ve dikiş pensleri	239	Perforatör	747
diseksiyon ve dikiş pensi	240	Periyost bıçak	19, 830
O'SULLIVAN-O'CONNOER, batin ekartörler	426	PERKINS, otomatik ekartörler	398
Obstetrik levye	569	PERWITZSCHKY, hassas makas	39
OBWEGESER, ekartörler	347	PHANEUF, periton ve histerektomi pensleri	248
ligatür iğneleri	810	PICCOLO, pamuk aplikatörleri	304
osteotom	662	PIERCE, raspa	619
OCHSNER, ATROMATİK aort klemp	277	trokar	316
ligatür penseti	107	PIPER, doğum pensi	569
safralı kanalı sondası	478	PITHA, yabancı cisim pensi	154, 502
OFFICER, doku penseti	121	Plak tutucu pens	814
OLDBERG, ronjur	740	Plasenta ve ovum pensi	574
OLIVECRONA, beyin kaşıkları	750	PLESTER, aspiratör uçları	306
kemik ronjuru	712	otomatik ekartörler	399, 400
trigeminal bıçak	17	POIRIER, doku tutucu	146
OLLIER, ekartör	343	POOL, aspiratör kanülleri	313
OMBREDANNE, çekiç	672	Popliteal ekartörler	430
Organ ve doku tutma pensi	152, 541, 656, 822	Poş açıcı	565
Otomatik ekartörler	394, 395, 413-417, 790	POTTS, diseksiyon makası	49
Otomatik ekartörler, Titanyum	416	POTTS-DE MARTEL, kardiyovasküler makaslar	67, 68, 477
Otomatik ekartör, Titanyum bleydler	417, 790, 791	POTTS-SMITH, damar cerrahi makası	71
Otomatik laminektomi ekartörler	407	kardiyovasküler makaslar	68
Otopsi bıçağı	831	Pozisyon pensleri	696-698, 700
OVERHOLT, diseksiyon ve dikiş pensler	237	POZZI, organ ve doku tutma pensi	153, 535
OVERHOLT-GIESSENDOERFER, diseksiyon ve dikiş pensleri	236, 238	uterin tenekulum pensi	534
OVERHOLT-MIXTER, diseksiyon ve dikiş pensi	236	PRATT, organ ve doku tutma pensi	152, 541
Oyucular	811, 823	rektal spekulum	463
Oyucu ve delici	811	uterin dilatörler	526
Ö		PROB, kılavuz sondası	201
Ölçü skalalı taslar	856	Prostat ekartörü	377, 497
P		Protez çıkartıcılar	821
Pamuk aplikatörleri	303	Protez itici	821
Pansuman pensleri	9, 38	PROVIDENCE, hassas hemostatik pensler	219
PAPAVERO, bayonet keski	779	PUTTI, kemik törpüsü ve raspaları	693
PAPAVERO-CASPAR, hipofizektomi spekulumları	778	Q	
PAPAVERO-HARTMANN, spekulum	778	QUERVAIN, elevator	634
PARKER, ekartörler	336	QUINBY, hassas makas	39
PARKER-KERR, anastomoz pensi	451	R	
PARKS, anastomoz bleyd	467	R.N.O.H, kemik biyopsi trapanı	812
rektal bleydler	467	RAABE, aspiratör uçları	309
rektal ekartör	467	RAGNELL, diseksiyon makasları	35
sfinker bleyd	467	ekartör	335
Parmak yüzük testeresi	824	RAMPLEY, tampon ve pansuman pensleri	140
Parmak yüzük testeresi, yedek bleyd	824	RAMSEY, diseksiyon penseti	107
PARRY-COOLEY, ATROMATİK anastomoz klemp	291	doku pensetleri	121
PARTSCH, gujlar	657	RANDALL, biyopsi küret	550
keskiler	656	böbrek taşı pensleri	492, 493
raspalar	620	RANEY, klip aplikatörü	752
PASSOW, iticiler	669	RANKIN, hassas hemostatik pensler	221
PAUL, ekartör	333	Raspalar	615, 621, 623, 630, 631, 633, 761
PAULSEN, raspalar	622	RAY, küretler	784
PAYR, bağırsak klempleri	447	RECAMIER, plasenta ve ovum küretleri	559
kılavuz sondaları	202	uterin kaşıkları	557
pilor klemp	447	REDON, kılavuz iğneleri	317
PEAN, ATROMATİK hemostatik pensler	260	REILL, mikro portegüler	163, 844
hemostatik pensler	226, 227, 229, 233, 486	pozisyon pensi	696
tüp klemp	11	tel makası, elmas kesici ağız	807, 815
PEDERSON, vajinal spekulumlar	510	tendon stripperler	826
PELKMANN, yabancı cisim pensleri	154, 482, 532	REIN-KUPKA, HARDMODEL portegüler	188
PENFIELD, disektörler	616	Rektal makas	458
raspa	615	Rektal spekulum	462
PENNINGTON, bağırsak tutma pensleri	150	REMINGTON-HOBB, elektrocerrahi aletleri	854
raspa	619	RESANO, kırıldak makası	57
PENNYBACKER, kemik ronjuru	712	ATROMATİK sigmoid anastomoz pensi	455
		REVERDIN, batin ve bağırsak malası	391
		sütür aleti, reverdin iğneleri	193



REYNOLDS, diseksiyon makasları	49	SCHNIDT, hemostatik pensler	234
REYNOLDS-JAMESON, vasküler makas	35	SCHOEMAKER, bağırsak klempi	446
RIBBON, batin ve bağırsak malaları	391	SCHOENBORN, yara ve damar ekartörü	331
RICHARD, batin ekartörleri	421	SCHRÖDER, kemik küretleri	556, 688
RICHARDSON, ekartörler	353, 354	organ ve doku tutma pensleri	151, 153, 535, 541
RICHARDSON-EASTMAN, ekartörler	354	uterin tenekulum pensleri	535, 540
RICHES, elektrocerrahi pensi	855	SCHUBERT, biyopsi pensleri	551
RICHTER, özel ekartör	408, 525	SCHUKNECHT, aspiratör uçları	308
panç	724	SCHULZ, biyoptom	604
RNTNE, otomatik ekartör	398	ekartörler	349
ROBERTS, hemostatik pensler	232, 233	SCHULZE, uterin kanüller	562
raspa	627	SCHUMACHER, biyopsi pensleri	551, 553, 555
ROBIN, çamaşır klempleri	157	göbek kordonu makası	72, 566
ROBIN-MASSE, batin ekartörler	421	kemik elevatörü	643
ROCHARD, batin ekartörler	388, 389, 488	sternum makası	606
batın ekartör bağlantı tertibatı	388	SCHUMACHER-WAGNER, kemik elevatörü	643
ROCHESTER-CARMALT, hemostatik pensler	232	SCHWEDISCHES MODELL, diseksiyon penssetler	107
ROCHESTER-OCHSNER, hemostatik pensler	230, 232	SCOVILLE, otomatik ekartörler	411, 412
ROCHESTER-PEAN, hemostatik pensler	228	SCOVILLE-HAVERFIELD, otomatik ekartörler	412
ROEDER, çamaşır klempi	156	SCOVILLE-RICHTER, ekartörler	411
ROGGE, sterilize pensi	887	SCUDDER, mide klempi	446
ROLLET, cilt ekartörleri	322	SEBILEAU, elevatör	634
Ronjurlar	733, 742	SEDILLOT, raspalar	625
ROSE, ekartör	335	SEGOND, histerektomi hemostatik pensi	250
ROTUNDA, irrigasyon kanülü	563	SEGOND-LANDAU, histerektomi ve hemostatik pensi	250
ROUX, ekartörler	336-338	SEIDL, vajinal spekulumlar	512
ROWBOTHAM, aspiratör ucu	312	SEIDLDBP, biyopsi pensleri	551
RÖTTGEN-RUSKIN, kemik ronjuru	713	SEIFFERT, sonda	302
RUBIN, kemik törpüsü ve raspaları	690	Sekestrum pensi	698
RUDD, hemoroid ligatörü	470	SELDIN, raspalar	627
RUMEL, diseksiyon ve dış pensleri	241	SELLORS, göğüs ekartörü	608
RUMEL-BELMONT, turnikeler	602	SELMAN, doku penseti	121
RUSKIN, kemik ronjuru	713	SEMB, kemik ronjuru	611, 716
RUSKIN-LISTON, kemik kesme pensler	719	kemik tutma pensleri	608, 699, 835
RUSS MODELL, doku pensetleri	121	raspalar	596, 597, 627
RUST, amputasyon testereleler	833	SEMKEN, doku pensetleri	116
amputasyon testere bleydleri	833	hassas diseksiyon penssetler	103
amputasyon testere sapı	833	SEMM, batin ekartörler	428
RYDER, DIAPOWDER mikro portegüler	165, 166	vajinal spekulumlar	511
HARDMODEL portegüler	186, 187	SENN-MILLER, ekartör	332
		Serklaç telleri	801
S		Servikal mikro disektomi küretler	684
SAALFELD, komedon ekstraktör	840	SEWALL, raspa	615
SACHS, raspa	615	SEYFFERT, vajinal spekulumlar	511
SAENGER, plasenta ve ovum pensleri	573	SIEBOLD, rahim makası	61
Safra dilatörleri	481	SILVER, cilt nakil bıçağı	20, 841
SAMI, tümör doku bıçakları	765, 766	SIMON, ekartörler	330, 360, 521
SAROT, HARDMODEL portegüler	178	kemik küretler	556, 683, 688
hassas hemostatik pensler	224	SIMPSON, doğum pensi	568
hemostatik pens	233	uterin sonda	530
SATINSKY, ATROMATİK buldog klemp	287	SIMPSON-BRAUN, doğum pensleri	568
damar cerrahi makası	71	SIMS, HARDMODEL rahim makasları	83
SAUER, otomatik ekartör	394	HARDMODEL rahim makasları, PerfectCut	90
SAUERBRUCH, ciğer spatulası	364	jinekoloji makasları	63, 65
ekartörler	348	rektal spekulumlar	462-464
göğüs makasları	609	uterin kaşıkları	558
tutma pensi	11	uterin sondalar	530
SAUERBRUCH-CORYLLOS, kemik ronjurları	611, 717	vajinal spekulumlar	516
SAUNDERS, biyopsi küret	550	SIMS SIEBOLD, rahim makası	58, 64
SCHADEL, çamaşır klempleri	155	Sınırlayıcı kalıplar	527
SCHAMBERG, küret	840	Silikon bölücü	527
SCHEDER, kemik küretleri	678	Sinir ve sinir kökü ekartörü	334
SCHERBACK, vajinal spekulumlar	524	Sinovektomi ronjuru	708
SCHINDLER, histerektomi hemostatik pensi	251	SMELLIE, plasenta ve ovum pensi	575
SCHINIC, dermatomlar	20, 841	SMILLE, ekartörler	350, 819
SCHMID, ağız açıcı	3	menisküs bıçakları	818
damar temizleme kanülleri	603	SMITH-BUIE, rektal ekartör	467
disektörler	596	SMITH-PETERSEN, gujlar	661
SCHMIEDEN, kılavuz sondası	201	osteotomlar	661
SCHMIEDEN-TAYLOR, dura makas	69	Soğuk ışık taşıyıcı	467
SCHNEIDER, raspa	625	Soğuk ışık taşıyıcı ve bleyd	467
SCHNEIDER-SAUERBRUCH, raspa	625	SOMER, uterin çıkartma pensi	544

Sonda	300-302, 472, 827, 834	Tel kesme pensleri, Elmas Kesici Ağız	805, 807
SPACKMAN, vulsllum kanülü	563	Tel kılavuzlar	800
Spanç pansuman pensi	134	Tel makası	806
Spanç pensleri	9, 138	Tel makasları, Elmas Kesici Ağız	806, 807
Spanç ve pansuman pensler	134, 137	Tel tabanlar	528
Spatula	304	Tel tutma pensleri	803, 804, 815
SPENCER, ligatür makaslar	78	Tel tutma pensi, Elmas Kesici ağız	802
SPENCER-WELLS, hemostatik pensler	227	Tel ve vida kesme makasları	809
SPURLING, ronjurlar	735, 736, 739	Tendon geçmeli pensler	144, 825
ST.BARTS, sinir ve damar huku	320	Tendon stripperler	826, 827
ST.MARKS, pelvis ekartörler	384, 461	Testis sabitleme klemp	500
ST.MARKS-GIRONA, perianal ekartör	467	THOMS-GAYLOR, biyopsi pensleri	551
ST.MARTIN, hassas göz penseti	114	THOREK, damar cerrahi makası	71
STAMM, kemik kesme pensi	718	THORPE, korneal penset	102
STELLBRINK, sinovektomi ronjurlar	708	Tırnak çıkarma pensleri	824
STELZNER, rektal makaslar	58, 457	Tırnak kesiciler	5
Steril konteynerler	528	Tırnak makasları	4, 5, 78
Sterilize pensler	857	Tırnak törpüsü	5
STERNBERG, ekartörler	339	TISCHLER, biyopsi pensi	555
Sternum ekartörler	588	Tiroid ekartörü	409
STEVENS, damar ve tendon makaslar	48	Torasik ekartörler	588, 590
diseksiyon makaslar	34	Tornavidalar	414, 778, 790, 814
hassas diseksiyon makası	48	Tornavida T kollar	817
STIEGLITZ, kıymık pensetler	123, 839	TÖNNIS, diseksiyon makaslar	51
STILLE, alçı makasları	796	disektörler	596, 618
böbrek klempeleri	488	dura ekartör	323
diseksiyon makasları	54	HARDMODEL portegü	189
gujlar	660	oluklu disektör	618
kemik ronjuru	714	portegü	175
keskiler	660	TÖNNIS-ADSON, diseksiyon makaslar	50
osteotomlar	660, 835	HARDMODEL diseksiyon makası	87
STILLE-BARRAYA, damar ve tümör pensetler	120	HARDMODEL diseksiyon makası, PerfectCut	90
STILLE-RUSKIN, kemik ronjuru	715	TÖNNIS MODIF., HARDMODEL portegü	189
STOCKMANN, penis pens	501	Traksiyon aletleri	746, 798, 799
STRANDELL-STILLE, ekartörler	329	Traksiyon aleti, matkap uçları	746
STRASSBURGER, doku pensetler	118	Traksiyon aleti, sabitleme diskleri	799
STRATTE, HARDMODEL portegüler	183	Traksiyon aleti, tornavida	798
STRAUSS, penis pens	501	Traksiyon anahtarı	799
STRUCK, göğüs ekartörleri	580	Traksiyon kancaları	799
STRULLY, damar makası	69, 477	TRAVERS, laminektomi ekartör	401
dura makas	69	TRELAT, raspa	621
SUBRAMANIAN, ATROMATİK aort klemp	278	vajinal spekulum	508
SUETIN, bandaj makası	76, 794	TRELAT, vajinal spekulumlar	508
Supercut diseksiyon makasları	92	TREVES, doku pensetler	118
Sütür aleti, ligatür iğneleri	198, 810	Trigeminal bıçak	17
Sütür pensetler	121, 125	TROELTSCH, açılı pensetler	113
SWEDISH, disektörler	614	Trokarlar	313, 316
SWEET, kemik pançları	748	TROTTER, kemik ronjuru	712
SYME, raspa	616	TROUSSEAU, tiroid dilatör	409
sütür aleti, ligatür iğnesi	198	TUDOR-EDWARDS, batin ekartör	381
SYPERT, ificiler	669	TUFFIER, arter tutma pensi	146
kemik küretleri	687	batin ekartör	381
kemik ronjuru	717	batin ve bağırsak malası	390
panç	724	göğüs ekartörleri	581
ronjur	742	TURANTAN, otomatik ekartörler	410
SYSTRUNK, cerrahi makas	45, 825	TURNER WARWICK, gerici buji	505
		batin ekartörler	427, 428
T		Turnikeler	602
TAGER, kemik elevatörü	647	TUTTLE, akciğer tutma penseti	122
Tahta ağız açıcı	3	TÜBINGER, ekartör	360, 521
TARNIER, doğum pensi	570	otomatik ekartör	400
Taslar, yuvarlak	864	safra taşı pensi	483
TAYLOR, ekartörler	410, 648	Tüp klempier	10, 11
otomatik ekartörler	412		
TEALE, uterin tenekulum pensler	538, 540	U	
Tel bükme pensi	804	UCHIDA, radikal histerektomi aletleri	547, 548
Tel bükücüler	803	UFFENORDE, kemik küreti	683
Tel çıkarıcılar	804	ULRICH, fistül bıçağı	16
Tel çıkarma pensleri	803	spanç ve pansuman pensi	137
Tel gerici	799	Ummikro disektomi küreti	685
Tel kesme makası	79, 805	UNNA, küret	840
Tel kesme pensleri	806, 808	US. ARMY, ekartör	339



Uterin sondalar	502, 530	WILLETT, kafa derisi tutucu pens	571
Uterin tenekulum pens	536	WILLIAMS, organ pens	141
Ü		WILLIGER, ekartörler	332
Üreter pens	500	kemik küretleri	679
Üretral ekartör	377	raspalar	620
V		elevatörler	634
Vajinal spekulumlar	517	WILSON, hemostatik pens	234
Vakum küretleri	315, 561	organ ve doku tutma pens	153, 534
Valf ekartörler	589	WILSON, HEY, elektrocerrahi pens	855
VALLEIX, uterin sonda	531	WINKELMANN, sünnet klempleri	501
VANNAS, mikro makas	28-30, 844	WINTER, plasenta ve ovum pensleri	572
VARADY, varis aletleri	599	WITT, sternal delme iğneleri	606
Venoz plexus pens	498	WOLFF, alçı kırıcılar	797
VERBRUGGE, kemik tutma pensleri	705	küretler	840
VERBRUGGE-MÜLLER, kemik elevatörleri	641	WOODSON, raspa	617
VERHOEVEN, aspiratör uçları	306	WÖRRLEIN, pozisyon tamperi	698
VIDAL, lupus kazıyıcı	840	WRIGLEY, doğum pens	569
VISE, mikro sütür bağlama pensetleri	99	WULLSTEIN, aspiratör uçları	307, 308
Vida çıkarma pens	817	otomatik ekartörler	398
Vida çıkartıcı T kol	817	Y	
VOLKMANN, ekartörler	340, 341	Yabancı cisim pens	154
kemik ekartörleri	341	YANKAUER, aspiratör kanülü	314, 607
kemik küretleri	676, 679	aspiratör ucu	314
W		Yara ve damar ekartörleri	331, 333
WACHTEL, DIAPOWDER mikro diseksiyon penseti	127	Yara ve soluk borusu ekartörü	325, 326, 500
DIAPOWDER mikro doku penseti	127	YASARGIL, aspiratör uçları	312
HARDMODEL mikro portegü	164	disektörler	759
WAGENER, sinir ve damar hukları	320	hareketli mikro ayna	758
WAGNER, çekiç	671	kanül	311
çekiç diski, metal	671	klip aplikatörleri	768
çekiç diski, plastik	671	klip aplikatörleri, titanyum	769
gujlar	666	mikro damar bıçakları	764
kemik elevatörü	635, 637	mikro disektörler	763
raspalar	633	mikro kaşık küret	763
ronjurlar	742, 743	mikro makas	30
tel uzatma	810	mikro portegü	162
WALLICH, plasenta ve ovum küreti	560	mikro raspalar	763
WALTER, gujlar	660	ronjurlar	740
osteotomlar	659	tümör, doku tutma pensetleri	110, 111
WALTON, biyopsi pens	469	yaylı huklar	753
WANGENSTEEN, HARDMODEL diseksiyon pensetleri	125	LEYLA ekartörler	770
HARDMODEL portegü	184	LEYLA ekartör bağlantı başlığı	771
portegü	173	LEYLA ekartör, esnek kol	770
WARD, raspa	620	LEYLA ekartör, masa bağlantı elemanları	771
WATSON cilt nakil bıçağı	20, 841	LEYLA ekartör, tespit elemanları	770
WATSON-CHEYNE, raspalar	616	Yaylı huklar	753, 774
WATSON-JONES, kemik elevatörü	638	Yedek bıçak	20, 841
WAUGH, hassas doku pensetleri	120	YEOMAN, biyopsi pens	468
WEBER, ATROMATİK aort anastomoz klempler	279	YOUNG, prostat ekartörü	497
WEBSTER, HARDMODEL portegü	176	YOUNG, HRYNTSCHAK, bumerang portegü	192, 499
portegü	170	Z	
WECKER, iridektomi makası	29	ZENKER, diseksiyon ve dikiş pensleri	242
WEIL-BLAKESLEY, ronjurlar	735	ekartörler	361
WEISSBARTH, vajinal spekulumlar	523	ZIELKE, gujlar	664
WEITLANER, otomatik ekartörler	396, 397, 401, 402, 845	Zincir ağırlık	821
WELLER, diseksiyon makası	57	Zincirli huk	774
menisküs pens	818	ZOELLNER, aspiratör uçları	306, 308
WERTHEIM, ATROMATİK histerektomi pensleri	252	ZUFAL-JANSEN, kemik ronjuru	713
HARDMODEL diseksiyon makasları	83	ZWEIFEL, HARDMODEL portegüler	191
HARDMODEL portegüler	183		
histerektomi hemostatik pensler	249, 250		
histerektomi pensler	254, 489		
jinekoloji makasları	65		
kompresyon pens	256, 490		
WERTHEIM-CULLEN, kompres pens	490		
WIENER MODELL, periton histerektomi pensleri	248		
WIKSTROEM, diseksiyon ve dikiş pens	240		
WILDE, açılı penset	113		

A-Z

İNGİLİZCE ALFABETİK İNDEKS
ENGLISH ALPHABETICAL INDEX



A		
ABBEY, mucosa needle	863	
Abdominal and intestinal spatulas	390, 750	
Abdominal retractors	420-422	
Abdominal retractor (chain and weight)	388	
Abdominal retractor, weight	388, 524	
Abdominal retractor, with chain	388	
Abdominal scissors	62	
ABEL, uterine tenaculum forceps	536	
ABRAHAM, tonsil knife	17	
ADAIR, uterine tenaculum forceps	534	
ADLERKREUTZ, vascular and tumor forceps	120	
ADSON, bone punch	748	
bone rongeur	712	
delicate dissecting forceps	102	
delicate forceps	114, 838	
delicate hemostatic forceps	222	
delicate tissue forceps	115	
delicate tissue forceps, Titanium	129	
electrosurgical instruments	854	
forceps, bayonet, shaped	112	
HARDMODEL dissecting forceps	124	
needle holder	172	
nerve and vessel hooks	320	
perforator	747	
raspatories	621, 624	
self, retaining laminectomy retractors	403, 405	
self, retaining retractors	399	
suction tubes	306	
tissue forceps	114	
ADSON-BABY, self, retaining retractors	399	
ADSON-BROWN, tissue forceps	115	
ALEXANDER, bone rongeur	710	
gouges	657	
raspatory	597, 626	
Alignment key	768	
ALLEN, intestinal clamp	438	
osteophyte chisel and scraper	621	
Allen T arm	817	
ALLENBERG, ATRAUMATIC hemostatic forceps	276	
bulldog clamp	605	
forceps	431	
iliaca retractors	431	
self, retaining retractor	401	
ALLIS, artery traction forceps	146	
ATRAUMATIC organ forceps	147, 459	
organ and tissue grasping forceps	147, 148	
tissue grasping forceps	147	
ALLIS-THOMS, organ tissue grasping forcep	148	
ALLISON, lung spatulas	363	
ALLPORT, self, retaining retractor	395	
ALM, self, retaining retractor	395	
Amputation knife	831	
Amputation saw	832	
Amputation saw blade	832	
ANGEL, wire cutting forceps	805	
Antrum punch	778	
Aorta punches	604	
Approximator	211, 845	
ASCH, secretion scoop	502, 550	
ASSMUS, probe	755, 826	
ATRAUMATIC, organ and tissue grasping forceps	143, 473, 543	
bronchus forceps	284, 452	
bulldog clamps	216	
coarctation clamps	295	
hemostatic forceps	260	
ultra, light forceps	108	
Attachment node	204	
AUFRIEHT, bone file and rasps	690	
AUSTIN, micro suture tying forceps	99	
Autopsy knife	831	
AUVARD, vaginal speculas	523	
B		
BABCOCK, organ and tissue grasping forceps	148, 149	
BABY CRILE WOOD, HARDMODEL needle holder	177	
Baby nail scissors	4, 78	
BABY-ADSON, dissecting and ligature forceps	235	
BABY-ALLIS, tissue grasping forceps	146	
BABY-COLLIN, abdominal retractors	420	
BABY-CRILE, delicate hemostatic forceps	219	
BABY-KOCHER, intestinal clamps	439	
BABY-METZENBAUM, dissecting scissors	50	
disecting scissors	94	
HARDMODEL dissecting scissors	85	
HARDMODEL dissecting scissors, PerfectCut	90	
Supercut dissecting scissors	92	
BABY-MIKULICZ, peritoneum forceps	246	
BABY-MIXTER, dissecting and ligature forceps	235	
BABY-OVERHOLT, dissecting and ligature forceps	235	
BABY-ROUX, retractor	336	
BABY-SENN-MILLER, retractors	332	
BACKHAUS, towel clamps	156	
BACKHAUS-KOCHER, towel clamp	156	
BAILEY, rib spreaders	608	
BAINBRIDGE, intestinal clamps	438	
BAKES, dilators	480	
BALFOUR, abdominal retractors	424, 425	
BALFOUR, BABY, abdominal retractor	423	
BALLANTINE, self, retaining retractor	410	
BANE-HARTMANN, bone rongeur	711	
BARNES-NEVILLE, obstetrical forceps	570	
BARPE, vasular and neurosurgery scissors	70, 498	
BARRAQUER, micro needle holders	163	
self, retaining retractor	394	
BARRE, bipolar forceps	499	
dissecting and ligature forceps	241, 498	
scalpel handles	22	
BARRON, hemorrhoidal ligator	470	
hemorrhoidal ligator conic loader	470	
hemorrhoidal ligator handle	470	
hemorrhoidal ligator shaft	470	
suction tubes	308	
BARSKY, fine wound retractor	324	
BART, bone curette	676	
BAUMGARTNER, HARDMODEL needle holder	177	
HARDMODEL wire twisters	182, 802	
needle holder	170	
Bayonet, shaped forceps	112	
BEACHAM, amniotome	565	
BECK, rongeur	736	
BECKMANN-ADSON, self, reta laminectomy retractors	404, 405	
BECKMANN-EATON, self, retaining laminectomy retractor	405	
BEEBE, wire cutting scissors	79	
BEHRMAN, uterine cannulas	562, 563	
BELLUCCI, suction tubes	308	
Bending irons	816	
BENGOLEA, delicate hemostatic forceps	224	
BENNETT, special bone levers	645	
BENSAUDE, anoscopes	465	
BENSON, stomach clamp	450	
BERGER, biopsy forceps	553	
BERGMANN, mallets	672, 673, 835	
plaster cutting scissors	75, 794	
scalpels	14	
wound and trached retractor	325	
BERKELEY-BONNEY, hysterectomy hemostatic forceps	251	
BERLIN, biopsy curette	550	
BERNHARD, uterine tenaculum forceps	156, 534	
BERRY, HARDMODEL wire twisters	182, 802	
BETHUNE, rib shears	609	
BEYER, bone rongeurs	711, 713	
BIEMER, applying forceps for vessel clips	210	

approximators	211, 845	ligature needles	200, 810
micro vessel clips	208	retractors	365, 367, 368, 386
nerve and vessel hook	754	rib shear	609
vessel clips	210, 847	sigmoid anastomosis forceps	452
BIEMER-MÜLLER , approximators	209, 845	suture instruments ligature needle	199
BIER , amputation saw	833	BRUNS , bone curettes	678, 682
amputation saw blades	833	plaster scissors	76, 795
amputation saw handle	833	BRÜNINGS , biopsy forceps cannulas	555
BIRCHER-GANSKE , meniscus forceps	818	rongeurs	733
BIRKETT , delicate hemostatic forceps	223	tongue depressors	2
BISHOP-HARMON , delicate eye forceps	114	BRYANT , sponge and dressing forceps	134
Biopsy forceps	468, 469, 554	BUCHWALD , tongue depressors	2
Biopsy forceps handle	468, 555	BUCK , cotton applicator	302
Blade ejector forceps	416	BUCK-GRAMCKO , bone levers	636
BLAKE , gall stone forceps	482, 602	BUELAU , trocars	316
uterine curette	560	Bulldog clamps	215, 605
Blood scoops	391, 831	BUMM , placenta and ovum curettes	559
BLOUNT , retractor	350, 819	uterine scoops	558
special bone lever	647	BUNNELL , hand drill	813
BLUMENTHAL , bone rongeurs	709	tendon strippers	827
BOER , placenta and ovum forceps	575	BUNT , safety pin	159
Bone biopsy trephines	812	BURKE , hysterectomy forceps	255, 549
Bone curettes	676, 677, 679, 680, 689	BUSHE , bone curettes	680
Bone cutting forceps	718, 719	BÜCHS , raspatory	624
Bone file and rasps	690, 691, 693	retractor	355
Bone holding forceps	700, 705, 706		
Bone levers	636-638, 640, 641, 644, 646	C	
Bone punch	748	CAIRNS , delicate hemostatic forceps	219, 220
Bone retractor	340	dura retractor	322
Bone rongeurs	708, 709	elevator	634
Bone shears	835	CAIRNS-DOTT , delicate dissecting forceps	105
Bone taps	814	Calipers	7
BONNER MODELL , micro suture tying forceps	99	CAMPBELL , nerve and nerve root retractor	334
BONNEY , dissecting forceps	107	Cannulas	315, 561
polypus and ovum forceps	545	CANNY-RYALL , retractors	338
tissue forceps	122	CARREL , delicate hemostatic forceps	218
BOROWSKI , aorta value retractors	595	CARTER , raspatory	616
BOSE , self, retaining retractor	394	Cartilage scissors	51
wound and trached retractors	325	CASPAR , attachment node	204, 755
Bowel and cartilage scissors	835	bone curettes	686, 687
Bowel scissors	59	dissector	615, 760
Bowl rounds	856	micro dissectors	760
Bowl with measuring scales	856	micro knives	767
BOWMAN , probes	302	nerve and nerve root retractors	334
BOZEMANN , uterine dressing forceps	532, 533	nerve and vessel hooks	321, 757
uterine scissors	61	raspatories	615, 623, 759
vaginal speculas	524	retractors	355, 414
vaginal specula, handles	524	rongeurs	738, 741, 743
BOZEMANN-DOUGLAS , uterine dressing forceps	533	scalpel handle	24
BÖHLER , bone cutting forceps	719	self, retaining retractors	413-415, 416
bone rongeurs	713	tampers	669
Braces	817	CASTANEDA , ATROMATIC anast and multi, purpose clamps	263, 264
BRAITHWAITE , skin graft knife,	21	CASTROVIEJO , delicate eye forceps	114
Brain shunts	748	eye scissors	29
Brain spatulas	750	HARDMODEL micro needle holders	164
BRAND , tendon seizing forceps	145	micro needle holders	162
BRAUN , organ and tissue grasping forceps	151, 539	Catheter guide	504
uterine depressor	531	CATLIN , amputation knife	18, 831
uterine tenaculum forceps	534	CAWTHORNE , cotton applicator	302
vaginal speculas	518	Cement extractors	823
BRAUN-STADLER , bandage scissors	73	Cement pushers	822
episiotomy scissors	73, 606, 567	Cerclage wires	801
BREISKY , vaginal speculas	516, 520	Cervical micro dissectomy curettes	684
BRIDGE , delicate hemostatic forceps	225	CHADWICK , delicate scissors	39
BRISTOW , bone level	635	Chain hook	774
BROCK , micro suture forceps	101	CHAMPIONNIERE , bone drill	811
BRODIE , probe	300, 472	CHANDLER , bone levers	628
BROM , nerve and vessel hook	320	CHAPUT , artery traction forceps	146
BROPHY , delicate dissecting forceps	104	CHARNLEY , tissue forceps	122
tissue forceps	118	CHARRIERE , amputation saws	832
BROWN , delicate tissue forceps	115	amputation saw blades	832, 833
BRUNNER , guiding probes	200	amputation saw handle	833



CHEATLE, sterilizing forceps	159, 857	suture instrument ligature needle	199
CHERON, sponge and dressing forceps	139	CORYLLOS, lung spatulas	364
Chisels	656, 662, 663, 665	COTLE, chisel	657
CINELLI, osteotomes	659	chisel and osteotome	657
CITELLI, punches	722	dissecting scissors	46
Clamp holders	450	dura retractor	323
CLAUS VAN EICKEN, suture instruments ligatur needle	199	fine wound retractor	322
Clip applicators	768	forceps, bayonet, shaped	112
Clip applicators, Titanium	769	mallet	672, 779
Clip applicator forceps	578, 579, 752	nasal speculums	778
Cloth scissors	76	osteotomes	657, 779
CLOWARD, center pins	789	raspatories	619, 623
coutery hook	788	retractors	329, 330
depth gauge	789	COTTLE-KNAP, scissors plastic surgery	50
dowel cutters	789	COTTLE-MASING, scissors plastic surgery	47
dowel cutter shaft	789	Cotton applicators	303
dowel ejector	789	CRAFOORD, delicate hemostatic forceps	225
dowel handle	789	CRAFOORD MOD, delicate hemostatic forceps	225
dowel holders	789	CRAIG, rongeurs	732
drill guards	789	CRAIG-DOMNICK, rongeur	732
drill guard cap	789	CRILE, delicate hemostatic forceps	220, 221
drill shafts	789	needle holder	175
drill tips	789	nerve and vessel hook	320
elevators	788	retractor	335
guard guides	789	CRILE-MURRAY, needle holder	171
handle inside diameter	789	CRILE-WOOD, HARDMODEL needle holders	178
lamina spreaders	419, 787	needle holders	171
mallets	670, 788	CRUCHFIELD, skull traction instruments	746
osteotome	788	CUSCO, vaginal speculas	509, 510
retractors	418, 786, 788	CUSHING, delicate dissecting forceps	104, 838
retractor blades	418, 786	delicate dissecting forceps, Titanium	130
wrenches	789	HARDMODEL dissecting forceps	125
COBB, gouges	668	nerve and vessel hooks	320
raspatories	628, 629	perforators	747
COBBETT, skin graft knife	21	rongeurs	737, 739
COBRA, bone levers	645	tissue forceps	118
COCK, rectal specula	464	wound and vein retractors	331
Cold light carrier	467	CUSHING-KOCHER, wound and vein retractor	331
Cold light carrier and blade	467	CUSHING-LANDOLT, hypophysectomy speculums	779
COLLER, delicate hemostatic forceps	221	Cutting terminator, for biopsy forceps	468, 469, 555
COLLIN, abdominal retractors	420, 422	CZERNY, gall stone forceps	482
clip removing forceps	204	organ and tissue forceps	151, 540
intestinal grasping forceps	150	rectal specula	462
kidney elevating clamp	491, 545	retractor	339
organ and tissue grasping forceps	143		
retractor	335	D	
sponge and dressing forceps	139	DAHLGREN, dura protector	749
tongue forceps	8, 41	hook	749
umbilical cord clamp	567	DANDY, delicate hemostatic forceps	220
uterine curette	560	DARDIK, ATRAUMATIC multi, purpose clamps	285
uterine elevating forceps	544, 545	DARLING, self, retaining laminectomy retractors	407
vaginal speculas	508	DARTIGUES, kidney elevating clamp	491, 544
COLLIN-HARTMANN, retractor	339	DAUBENSPECK, bone curettes	680
COLLIN-POZZI, uterine tenaculum forceps	534	DAVIDSON, scapula retractors	366
Comedone extractor	840	DAVIS, dissector	596, 614
CONE, laminectomy retractor	401	raspatory	614
CONVERSE, fine wound retractor	324	DE BAKEY, arteriotomy scissors	49
HARDMODEL needle holder	177	ATRAUMATIC anastomosis multi, purpose clamps	264
needle holder	170	ATRAUMATIC aorta anastomosis clamp	280
COOLEY, ATRAUMATIC anastomosis and multi, purpose clamps	264, 265, 292	ATRAUMATIC aorta aneurysm clamps	274-276
ATRAUMATIC anastomosis clamps	288, 290, 293	ATRAUMATIC aorta clamp	278
ATRAUMATIC aorta clamp	297	ATRAUMATIC bulldog clamps	217, 262
ATRAUMATIC bulldog clamps	286, 287	ATRAUMATIC coarctation clamps	271
ATRAUMATIC coarctation clamps	294	ATRAUMATIC dissecting ligature forceps	282
ATRAUMATIC forceps	108	ATRAUMATIC ductus clamps	269
ATRAUMATIC multi, purpose clamps	289, 296	ATRAUMATIC forceps	108, 109, 459
atrium retractors	592-594	ATRAUMATIC forceps, Titanium	131
delicate dissecting forceps	105	ATRAUMATIC micro forceps	108
sternum retractors	587	ATRAUMATIC multi purpose clamps	272
vascular and neurosurgery scissors	70	ATRAUMATIC peripheral vascular clamps	269, 270
COOLEY-BECK, ATRAUMATIC anastomosis clamps	288	ATRAUMATIC sigmoid anastomosis forceps	273, 454
COOPER, surgical scissors	42	ATRAUMATIC tangential occlusion clamps	268

ATRAUMATIC ultra, light forceps	131	needle holder	171
cardiovascular scissors	67, 68	probe	300
femur retractors	408	raspatories	598, 632
HARDMODEL needle holders	178, 179	towel clamps	155
HARDMODEL vascular scissors	84, 477	vaginal speculas	522
rib retractors	583, 585	Dressing forceps	9, 138
sternum spreaders	586	Drill guides	817
suction cannulas	314, 607	Drill T arm	817
TITANIUM ultra light forceps	131	Drilling chucks	812
vascular dilators	600, 601	DUBOIS , uterine scissors	64
DE BAKEY-BAINBRIDGE , ATRAUMATIC hemostatic forceps	260	DUNHILL , delicate hemostatic forceps	218, 223
DE BAKEY-BECK , ATRAUMATIC vena cava clamps	267	DUPLAY , sponge and dressing forceps	135
DE BAKEY-HESS , bulldog clamps	214	uterine tenaculum forceps	536
DE BAKEY-KELLY , ATRAUMATIC, hemostatic forceps	260	Dura and skin retractor	324, 757
DE BAKEY-MC QUIGG-MIXTER , ATRAUMATIC bronchus clamp	281	Dura retractor	323, 757
DE BAKEY-MIXTER , ATRAUMATIC dissecting ligature forcep	283	DURHAM , retractor	352
DE, BAKEY-PEAN , ATRAUMATIC hemostatic forceps	261	DUVAL , intestinal grasping forceps	150
DE BAKEY-SATINSKY , ATRAUMATIC tangential occlusion clamps	268	intestinal forceps	122
DE LEE , pelvimeter	564	DUVAL-COLLIN , organ tissue grasping forceps	149
DE MARTEL , conductor	749		
DE MARTEL-WOLFSON , anastomosis clamps	450	E	
closing forceps	450	EAST GRINSTEAD (WARD) , chisels	658
DE VILBISS , dura protector	749	EAST GRINSTEAD , osteotomes	658
DEAVER , retractors	369-374	EASTMAN , chisels	658
surgical scissors	45	vaginal specula	518
Delicate dissecting forceps	103-105, 838	ECHLIN , bone rongeurs	714
Delicate dissecting forceps, Titanium	130	Electrodes	856-862
Delicate dissecting scissors	103	Electrode cables	863
Delicate scissors	4, 34, 36-40	Electrode container	858, 859
DEMEL , wire guides	800	Electrode hol	863
twisting forceps	801	Electrode racks	858
DENIS-BROWNE , abdominal retractors	428	Electrosurgical instruments	848-855
intestinal forceps	122	Elevator	634
Depth gauges	814	EMMET , retractor	330
DERF , HARDMODEL needle holder	177	sponge and dressing forceps	139
needle holder	170	Enderarterectomy strippers	603
DERRA , ATRAUMATIC anastomosis and multi, purpose clamps	265	ENGEL , plaster saw	795
DERRA, COOLEY , ATRAUMATIC anastomosis clamp	289	ENGIL MOD , towel clamp	155
DESCHAMPS , suture instruments, ligature needles	194-197	Episiotomy scissors	73, 567
DESJARDINS , dissecting and ligature forceps	244, 476	EPPENDORE , biopsy forceps	553
gall duct probes	478	EPSTEIN , bone curettes	681
gall stone forceps	483	ESMARCH , plaster cutting scissors	75, 794
gallstone scoops	479	plaster knife	795
DESMARRES , retractors	330	Extraction pliers	804
DETHRICH , cardiovascular scissors	67	Extraction pliers for wires	803
DIAPOWDER micro forceps	125-127		
DIAPOWDER micro forceps, Titanium	128	F	
DIAPOWDER micro needle holders	165, 166, 168, 169	FAHLBUSCH , micro curette	783
DIAPOWDER micro needle holders, Titanium	167	micro spoon	783
DICK , ATRAUMATIC anastomosis clamps	256, 284, 451	FARABEUF , bone holding forceps	701
ATRAUMATIC anastomosis forceps	451	raspatories	626
DIEFFENBACH , bulldog clamps	214	retractors	335
DIETHRICH , ATRAUMATIC aorta clamp	277	FARABEUF-COLLIN , raspatories	626
bulldog clamps	215	FARABEUF-LAMBOTTE , bone holding forceps	701
DINGMANN , bone holding forceps	699	FARRELL , cotton applicators	303, 304
DITTEL , urethral dilating bougies	504	FAURE , biopsy forceps	551
DIXON-LOVELACE , delicate hemostatic forceps	222	peritoneum & hysterectomy forceps	247
Dilator	754	FAVOLORO , cardiovascular scissors	68
Dissecting and strabismus scissors	34	FEILCHENFELD , splinter forceps	123, 839
Dissecting forceps	106, 107, 834, 836	Femoral retractor	644
Dissecting and ligature forceps	235, 236	FERGUSSON , bone holding forceps	700, 835
Dissecting forceps, Titanium	130	pressure clamps	474
Dissecting scissors	46	suction tubes	305
Dissectors	615	FERGUSSON-ACKLAND , mouth gag	3
Distractors	698, 799	FERRIS-SMITH , HARDMODEL dissecting forceps	125
DOCKHORN , retractors	355	FICKLING , hemostatic forceps	232
DOUNAY , biopsy forceps	554	mallet	670
DOYEN , abdominal retractors	380, 382, 387, 388, 519	FINECHIETTO , dissecting and ligature forceps	244
hemorrhoidal forceps	474, 543	HARDMODEL needle holder	186
intestinal clamps	438-441	rib retractors	580-583
lateral speculums	522	thoracic retractors	591
myoma screws	546		



FINOCHIETTO-BURFORD, rib retractors	584	GLUCK, rib shear	609
FINSEN, self, retaining retractors	394, 395, 845	GOELET, retractor	337
FINSTERER, irrigation cannula	315, 607	GOLIGHER, abdominal retractor	426
FISCH, dura and skin hook	324, 757	GORNEY, dissecting scissors	51
Fiber light attachment for NAUNTON, MORGAN	466	suction dissector	311
Finger goniometer	7	Supercut dissecting scissors,	93
Finger ring saw	824	GOSLEE, Wire holding forceps	803, 815
Finger ring saw, replacement blade	824	GOSSET, abdominal retractors	423, 424
Fistula knives	16	Gouges	656, 664, 666-668, 817, 822
Fistula probe	472	GOURDET, bone curettes	556, 688
FOERSTER BALLANGER, sponge dressing forceps	140, 474	GRAEFE, delicate tissue forceps	115
FOMON, bone file and rasps	691	dissecting scissors	46
dissecting scissors	47	nerve and vessel hooks	320
osteotomes	659	skin retractors	322
retractor	329	GRAVE, vaginal speculas	510
Forceps	823	GRAY, dissecting and ligature forceps	244, 475
Foreign body forceps	154	GREEN-ARMYTAGE, caesarean hemostatic forceps	571
FORMBY, suction tube	307	GREENE, retractor	352
FOWLER, tonsil knife	17	GREGORY, ATRAUMATIC profunda clamps	282
FOX, curettes	840	GREY-TURNER, delicate hemostatic forceps	223
FÖRSTNER, reposition forceps	697	GROSS, dressing forceps	9, 135
FRASER-KELLY(CRILE), delicate hemostatic forceps	223	sponge and dressing forceps	134
FRAZIER, dura retractor	322	sponge forceps	9, 135
raspatory	617	GRUENWALD, dissecting forceps	125
suction tubes	305	forceps, bayonet, shaped	112
FREER, chisels	656	Guides	815
fine wound retractor	322	Guide pins	815
gouge	656	Guide sheath	564
raspatories	596, 614, 616, 617	Guiding probes	203
FREER-YASARGIL, raspatory	614	GULEKE, bone rongeur	712
FRENZEL, tongue depressors	2	GUTHRIE, skin retractors	322
FRIEDMANN, bone rongeurs	708	GUYON, catheter guide	504
FRITSCH, abdominal retractors	383	introducer for catheter	504
FRYKHOLM, bone rongeur	714	kidney clamps	486-488
FUCHSIG, delicate hemostatic forceps	222	urethral dilating bougies	505
FUKUSHIMA DESING, suction tubes	309	GWILLIAM, hysterectomy hemostatic forceps	251
G			
GABRIEL, rectal speculum	466	H	
GALABINS, uterine probe	531	HAASE, reposition forceps	696, 697
Gall duct dilators	481	tamper	669
GALLAHER, bone file and rasp	691	HABERER, abdominal and intestinal spatula	391
GARDNER, WELLS, skull traction instrument	746	gastro, intestinal forceps	449
Gel ear ring bases	777	HAIGHT, rib retractor	581
GELPI, skin and vaginal retractor	408, 525	HAJEK, irrigating cannula	478
vaginal retractor	408, 525	mallet	670
GEMINI, dissecting and ligature forceps	238	retractor	338
GERALD, delicate dissection forceps	104	HAJEK-KOFLER, punches	723
micro forceps	101	HAKANSSON, bone rongeur	709
tissue forceps	118	HALLE, bone curettes	680
GERSTER, bone clamp	707	elevator	596, 615
GIERTZ, STILLE, rib shear	609	HALSEY, HARDMODEL needle holders	176, 177
GIGLI, wire saws	749, 810, 832	needle holders	170
GILLIES, delicate dissecting forceps	104	HALSTED, delicate hemostatic forceps	222
electrosurgical instruments	854	HALSTED-MOSQUITO, delicate hemostatic forcep	218, 223
fine wound retractors	323	Hand drill	813
HARDMODEL needle holder	181	Hand grips	655
needle holders	174	Hand stabilizers	824
osteotomes	659	Hand valve and connection hose	561
suction tube	307	Handle for blade	417, 790, 791
tissue forceps	119	dissecting scissors	94
GILSBACH, combined retractor semi, circular basic bar	772	dissecting scissors, PerfectCut	95
combined retractors	772	transspenoidal specula	778
combined retractor fixation attachments	773	HARDMODEL bone file and rasps	692, 693
combined retractor handrest bar	773	HARDMODEL delicate ligature scissors	80
combined retractor, frame	772	HARDMODEL delicate scissors	80
combined retractor, holding rod	772	HARDMODEL dissecting forceps	85, 124, 125
retractor system	772-774	HARDMODEL dissecting scissors, PerfectCut	90
Gland and the foreskin forceps	500	HARDMODEL hysterectomy scissors	84
GLASSER, DIAPOWDER micro needle holders	166	HARDMODEL ligature scissors, PerfectCut	88, 89
GLOVER, ATRAUMATIC anastomosis clamps	266	HARDMODEL needle holders	179, 183, 184, 187, 190, 191
ATRAUMATIC bulldog clamps	217	HARDMODEL needle holder with scissors	181
		HARDMODEL surgical scissors	80, 81

HARDMODEL surgical scissors, PerfectCut	89	HOHMANN, bone levers	639
HARDMODEL wire cutting scissors	84, 805	HOHMANN-ALDINGER, bone lever	646
HARDMODEL wire twisters	182, 802	HOLZBACH, abdominal retractors	421, 422
HARDY, curettes	784	hysterectomy hemostatic forceps	251
dissectors	780	HOPT, ATRAUMATIC kidney & pancreas clamps	277
implant fork	782	HOSEMANN, delicate hemostatic forceps	475
HARDY-FAHLBUSCH, dissectors	780, 781	HOUSE, suction tubes	306, 310
HARRINGTON, lung spatulas	362	HOWARTH, raspatory	615
HARRINGTON-PEMBERTON, lung spatula	362	HÖSEL, HARDMODEL needle holder	191
HARTMANN, intestinal clamps	438	retractors	359, 460
cotton applicator	304	HUBER, biopsy forceps handle	555
delicate hemostatic forceps	218	HUDSON, perforators	747
intestinal clamps	439	tissue forceps	114
HARVEY, wire cutter, with carbide cutting	807	HUDSON-DOWNS, perforators	747
wire cutting scissors	79, 805	HUMBY, skin graft knife	21
HARVEY-JACKSON, self, retaining laminectomy retractor	405	HUNTER, splinter forceps	123, 839
HASSON, retractors	369	HURD, dissectors	619
HEANEY, ATRAUMATIC hysterectomy forceps	252	suture instruments, ligature needles	194
HARDMODEL needle holders	183		
needle holder	172	I	
peritoneum hysterectomy forceps	248	Incision scissors	45
uterine curette	560	INGE, lamina spreaders	419, 787
vaginal specula	518	Injection needle	564
HEANEY-BALLENTINE, hysterectomy hemostatic forceps	249	Interosseous knife	18, 830
HEANEY-REZEK, peritonum hysterectomy forceps	247	Intima dissectors	596, 759
HEATH, clip removing forceps	204	IRWIN MOORE, rongeur	733
mallets	672	IRWIN, self, retaining retractor	400
HEBRA, comedone extractor	840	ISRAEL, retractors	343
HEGAR, HARDMODEL needle holders	180	IVES-FANSLER, anoscope	465
needle holders	172		
uterine dilators	526	J	
HEGAR-MAYO-SEELEY, HARDMODEL needle holder	179	JACKSON, tendon seizing forceps	144, 825
HEGAR-OLSEN, HARDMODEL needle holder	181	vaginal speculas	515
HARDMODEL needle holder scissors	181	JACKSON-BURROWS, retractor	408
needle holders	174	tissue forceps	122
HEGENBARTH, clip applying forceps	204	JACOBS, uterine tenaculum forceps	537
HEIFETZ, brain spatulas	750	JACOBSON, bone curette	676
forceps for grasping tumor, tissue	111	delicate hemostatic forceps	219, 223
vessel spreader	754	dilators	755
HEIMING, kidney stone forceps	492	micro needle holders	162
HEISS, delicate hemostatic forceps	224	micro scissors	30
HEISTER, mouth gag	3	micro vessel knife	764
HELLBERG-KUPKA, HARDMODEL needle holder	188	JAGER, dura retractor	323
HEMANN-KNIGHT, rongeur	732	tendon seizing forceps	145
HEMINGWAY, bone curettes	677	JAMESON, dissecting scissors	49
Hemi, laminectomy hooks	790	needle holder	172
Hemi, laminectomy retractor	404	Supercut dissecting scissors	92
Hemorrhoidal ligators	471	JAMESON-WERBER, dissecting scissors	49
Hemorrhoidal ligator handle	471	JANSEN, bone curettes	676, 677
Hemorrhoids rubber	470	bone rongeurs	710
HENCKEL-TILLEY, rongeur	735	forceps, bayonet, shaped	112
HENDERSON, self, retaining retractor	399	raspatory	624
HENKE, raspatories	619	self, retaining retractor	395
HENNING, plaster spreader	797	JANSEN-MIDDLETON, septum forceps	779
HERFF, membrane puncturing forceps	565	JEFFERSON, delicate dissecting forceps	102
HERRECK, kidney pedicle clamps	489	delicate tissue forceps	115
HERTZLER, rib retractor	580, 423	self, retaining retractor	398
HERZ, tendon seizing forceps	144, 825	JENKNER, tunneling forceps	605
HESS, nerve root retractors	334	JEWETT, bending irons	816
HEY GROVES, bone holding forceps	704, 705	JOHNS-HOPKINS, apply forceps for vessel clip	214
HEYMANN, rongeur	732	bulldog clamps	214
HEYWOOD-SMITH, organ and tissue forceps	142, 474, 542	JOLL (FREEDMAN), thyroid vaginal retractor	409, 525
HEYWOOD-SMITH, tongue forceps	8, 140, 141, 473, 543	JONECO, suture instrument ligature needle	198
HIBBS, gouges	661	JONES, towel clamp	155
osteotomes	661	JOSEPH, bone file and rasp	690
retractors	648	bone file and rasp	690
HIBBS-SPRAIT, bone curettes	681	delicate scissors	34, 38
HILL, raspatory	618	double, edged nasal knives	16
HIRSCHMANN, rectal speculas	464	raspatory	621
Hib retractor	821	skin retractors	323
HOEN, raspatories	617	hand saw	825
rongeurs	742		



Supercut dissecting scissors	93	KOOS, micro vessel knives	764
JUDD-ALLIS, organ tissue grasping forcep	148	KÖNIG, guiding probes	201
K		raspatory	620
KADER, abdominal and intestinal spatula	390	wound and vein retractors	331
KALLMORGEN, vaginal speculas	516	KÖRTE, retractors	343, 376
KANTROWITZ, dissecting ligature forceps	241	KÖRTE-WAGNER, retractor	342
KAZANJIAN, bone cutting forceps	718	KRAMER, chisel	658
KEIBACK, dissecting and ligature forceps	245, 547	raspatories	624
KELLY, abdominal retractors	379	retractor	355
anoscope	465	rongeurs	740, 743
delicate hemostatic forceps	219	KRAUSE, biopsy forceps tip	555
delicate scissors	38	trocac	316
organ and tissue forceps	142, 542, 574	KRAYENBULH, nerve and vessel hooks	321, 756
proctoscope	466	KRISTELLER, vaginal speculas	512-515, 517
rectal speculas	464	KRONECKER, suture instruments ligature needles	194
retractors	353	KRONLEIN, hemostatic forceps	226
sphincteroscope	465	KUNTSCHER, reamers	820
KERN-LANE, bone holding forceps	702	T arm	820
KERN-MINI, bone holding forceps	703	KÜMMEL, retractor	376
KERPEL, bone curettes	683	KÜSTNER, uterine tenaculum forceps	538
KERRISON, bone punches	726-729	L	
punches	722, 725	LA GRANGE, delicate scissors	40
bone punch	726, 727	LABORDE, thyroid dilators	409
KERSTING, ATRAUMATIC sigmoid anastomosis forceps	455	LAHEY, organ and tissue grasping forceps	151, 539
KEVORKIAN, biopsy forceps	554	retractor	351
Keys	662, 812, 813, 845	LAHEY(SWEET), dissecting and ligature forceps	245, 476
KEY, raspatories	629	LAHGENCBEK, HARDMODEL needle holders	189
KEYES, dermal punches	838	LAMBERT, KAY, ATRAUMATIC aorta anastomosis clamps	280
KIEBACK, ATRAUMATIC hysterectomy forceps	253	LAMBOTTE, bone holding forceps	706
paramerium scissors	60, 548	osteotomes	659, 662
KIELLAND, obstetrical forceps	569	raspatories	597, 626
KILLIAN, bone shears	77	LANCASTER, self, retaining retractor	394
probe	302	LANDAU, trocac	316
raspatories	615, 617	vaginal speculas	520
rectal specula	462	LANDOLT, cannula	315, 863
KILNER, delicate dissecting scissors	46	curette	781
dissecting scissors	47	dissectors	781
fine wound retractors	322, 324, 840	enuclation scissors	47
HARDMODEL needle holder	177	hook	781
needle holder	171	raspatory	623
retractors	332, 337	rongeur	740
KING'S COLLEGE HOSPITAL, cotton applicators	302	scalpel handles	25
KIRSCH, retractors	349	spoon	781
KIRSCHNER, abdominal retractors	429	spreader	779
guiding probe	203	suction tube	310
traction instruments	799	LANDOLT-REULEN, dissector	782
Kidney trays	864	hook	783
KLAPP, wound and vein retractor	333	raspatories	783
KLEINERT-KUTZ, fine wound retractors	323	LANDON, vaginal specula	518
tendon passing forceps	145	LANE, bone holding forceps	702, 703
KLEINSCHMIDT, appendectomy clamp	450	bone level	635
KLIMA-ROSEGGER, trocac	316	gastro, intestinal forceps	448
KLINIKUM BERLIN, tubing clamp	11	retractors	338
KLINKENBERGH, scissors for vascular surge	71	tissue forceps	120
Knee retractors	350, 351, 819	towel clamp	155
KNOWLES, bandage and cloth scissors	74	LANE-TRETHOWAN, bone level	635
KOCHER, bladder retractor	495	LANG-STEVENSON, intestinal clamp	446
bone retractors	340	LANGE, retractor	330
depressor	391	LANGE-HOHMANN, bone levers	642
guiding probes	202	LANGENBECK, bone holding forceps	700
hemostatic forceps	230	elevators	634, 635
intestinal clamps	440, 442, 443	flap knife	18, 830
retractors	342, 348	metacarpal saw	832
suture instrument ligature needle	199	raspatories	597, 625, 626
wound and vein retractors	333	resection knife	19, 830
KOCHER-LANGENBECK, retractors	345	retractors	344, 346
KOCHER-OCHSNER, hemostatic forceps	231	LANGENBECK-GREEN, retractors	329
KOCHER-WAGNER, retractors	358	Laryngeal Mirrors	6
KOFLER, punch	724	LATHBURY-FARRELL, cotton applicators	302-304
KOGAN, endo speculas	529	LAWRENCE, dissecting and ligature forceps	243
KONIG, elevators	634	needle holder	170

LAZAR, micro suture tying forceps	99	MAC DONALD, dissector	616
LEBSCHÉ, conductor for wire saw	832	MAGILL, suction tubes	312
sternum chisel	606	tongue forceps	8
LEECH-WILKINSON, biopsy forceps	554	MAIER, sponge and dressing forceps	136
uterine cannulas	562	MAINGOT, hysterectomy hemostatic forceps	249
LEES, ATRAUMATIC bronchus clamps	281	Mallets	670, 671, 673, 823
LEGUEU, bladder spatula	495, 430	Mallet, pair of spare discs	671
LEITZ, ATRAUMATIC anastomosis clamp	291	MALTZ, bone file and rasp	690
LEKSELL, bone rongeur	714	Mamilla markers	7
bone rongeur	714	Mammaria retractor	588
LEKSELL-STILLE, bone rongeur	715	MANNERFELT, gouge	658
LELAND-JONES, ATRAUMATIC peripheral vascular clamps	270	osteotomes	658
LEMBERT, bone rongeur	708	raspatories	622
bone curettes	680	retractors, triangle handle	327, 328
bone rongeurs	710	MARQUARD, bone rongeur	713
raspatories	621	MARTIN, pelvimeter	564
suction tubes	307	retractor	360, 521
LERICHE, delicate hemostatic forceps	220	MARTINI, bone curettes	676
retractors	375	MASING, cartilage slitting knife	16
LEWIN, bone clamp	698	HARDMODEL needle holder	176
LEWIS, bone file and rasps	690	osteotomes	659
LEWKOWITZ, placenta and ovum forceps	575	retractor	330
LEXER, dissecting scissors	55	MASSON, HARDMODEL needle holder	184
gouges	663, 664	needle holder	173
HARDMODEL dissecting scissors	82	MASSON-LUETHY, needle holder	173
HARDMODEL dissecting scissors, PerfectCut	89	MATHEU, foreign body forcep	502
osteotomes	663, 665	HARDMODEL needle holders	190
LEXER-MINI, gouges	663	needle holders	175
osteotomes	663	rectal specula	463
LICHTENBERG, HARDMODEL needle holder	190	retractor	339
LINDEMANN, hand saw	825	vaginal speculas	518
LISTER, bandage and cloth scissors	74, 75	MATHIEU-STILLE, needle holders	175
sinus forceps	134	MAYFIELD, bone rongeur	713
LISTON, amputation knives	18, 830	headrests	777
bone cutting forceps	718, 720	headrest extension bar	777
LISTON-KEY-HORSLEY, bone cutting forceps	610, 721	headrest extension bar	777
LISTON-STILLE, bone cutting forceps	610, 721	skull clamp	776
LITTLER, dissecting scissors	46	table fixation attachments	776
LITTLEWOOD, uterine tenaculum forceps	538	MAYNIHAN, gall stone probe	478
Ligature guides	756	intestinal clamp	445
Ligature scissors	78	MAYO, dissecting scissors	53, 55, 82
Limiting bars	527	gall duct probe	478, 530
LLOYD-DAVIES (GOLIGHER'S), rectal scissors	58, 457	HARDMODEL dissecting scissors	81, 82
LLOYD-DAVIES, biopsy forceps	468	HARDMODEL dissecting scissors, PerfectCut	89
LLOYD-DAVIS, sigmoid anastomosis forceps	453	safety pins	159
LOCKHART-MUMMERY, probes	300, 472	surgical and dissecting scissors	56
LOCKLIN, delicate scissors	40	Supercut dissecting scissors	93
LOCKWOOD, intestinal grasping forceps	150	MAYO-ADAMS, self, retaining retractor	400
LOGAN-REILL, self, retaining retractor	394	MAYO-HARRINGTON, dissecting scissors	55
LOPEZ-REINKE, tonsil dissector with suction	311	MAYO-HEGAR, needle holder	171, 172
LORNA, towel clamps	158	HARDMODEL needle holders	180
LOUTE, wire tightener	801	MAYO-LEXER, dissecting scissors	54
LOVE, nerve and nerve root retractors	334	dissecting scissors	94
LOVE-GRUENWALD, rongeurs	739	disecting scissors, PerfectCut	95
LOWER, dissecting and ligature forceps	245	HARDMODEL dissecting scissors	82
LOWMAN, bone clamps	707	HARDMODEL dissecting scissors, PerfectCut	89
LOWMAN-GERSTER, bone clamp	707	MAYO-NOBLE, dissecting scissors	54
LOWMAN-HOGLUND, bone clamp	707	MAYO-ROBSON, intestinal clamps	444
LUC, rongeurs	733, 734	MAYO-STILLE, dissecting scissors	53
LUCAE, forceps, bayonet, shaped	112	surgical and dissecting scissors	56
LUCAS, bone curettes	677	MC CLINTOCK, placenta and ovum forceps	574
chisels	658	MC CLURE, micro scissors	28
gouges	658	MC GIVNEY, hemorrhoidal forceps	470
LUER, bone rongeurs	709, 711	MC INDOE, bone cutting forceps	719
hemorrhoidal forceps	473	delicate dissecting forceps	105
retractor	335	dura and skin hooks	324
LUER-FRIEDMANN, bone rongeur	709	tissue forceps	119
LUER-KÖRTE, gallstone scoops	479	MC KENTY, raspatory	620
LUER-STILLE, bone rongeurs	715, 716	MC KENZIE, clip applicators	752, 753
Lumbar micro dissectomy curettes	685	perforator	747
		MC KISSOCK, raspatory	625
		MEAD, bone rongeur	709

M



mallet	671	MUNCHEN, biopsy curette	550
mallet, pair of spare discs	671	MURPHY, retractors	344
raspatory	620	MURPHY-LANE, luxation lever	647
MEHDORN, vessel clips	208, 210	MUSEUX, organ and tissue forceps	151, 539
Meniscus forceps	818	uterine tenaculum forceps	537, 538
MERBURG MODELL, wire twister	803	MÜHLING, raspatories	623
Metal catheter	503	approximators	209
METZAMBAUM, electrosurgical scissors	855	MÜLLER, ATRAUMATIC rectal anastomosis clamp	456
dissecting scissors	35, 50, 52	ATRAUMATIC vessel clips	213
disecting scissors	94	fine wound retractors	322
disecting scissors, PerfectCut	90, 95	HARDMODEL needle holder	185, 459
HARDMODEL dissecting scissors	85-87	ligature forceps	212
HARDMODEL dissecting scissors, PerfectCut	90, 91	micro forceps	100
Supercut dissecting scissors	92	micro needle holders	162
METZENBAUM-NELSON, HARDMODEL dissecting scissors	87	micro scissors	33
MEYER, reposition forceps	697	rectal scissors	59, 458
MEYERDING, retractors	332, 357	retractors	385, 497
self, retaining laminectomy retractors	407	vessel clips, non, traumatic	212
self, retaining retractors	406		
MICHEL, clip applying & removing forceps	204	N	
clip applying forceps	204	NABATOFF, varix instruments	599
rhinoscopic mirror	6	NAGELE, obstetrical forceps	568
MICRO-ADSON, delicate dissecting forceps	102, 128	Nail cutters	5
delicate forceps	114	Nail extracting forceps	824
delicate tissue forceps, Titanium	129	Nail file	5
dissecting and ligature forceps	235	Nail scissors	4, 5, 78
MICRO-ADSON-BEIMER, delicate forceps	114	NAUNTON MORGAN, HARDMODEL needle holder	185
MICRO-HALSTED, delicate hemostatic forceps	218	speculas	466
MIDDELDORPF, retractors	352	Needle cases	205
MIKULICZ, abdominal retractors	378, 379, 387	NEGUS, hemostatic forceps	234
hemostatic forceps	234	suction dissector	311
peritoneum forceps	246	NELATON, probe	300
peritoneum hysterectomy forceps	247	NELSON, lung grasping forceps	122
MILLER, bone file and rasps	691	NELSON-METZENBAUM, dissecting scissors	52
MILLESİ, micro scissors	30	HARDMODEL dissecting scissors	86
MILLIGAN, raspatory	617	HARDMODEL dissecting scissors, PerfectCut	91
MILLIN, bladder neck spreader	495	NELSON-METZENBAUM(MC INDOE), HARDMODEL dissecting scissors	86
bladder retractors	494, 430	Nerve and nerve root retractor	334
ligature holding forceps	192, 496	Nerve dissecting scissors	35, 49
MILLS, cardiovascular scissors	68, 477	NICOLA, curettes	785
MINI-FINOCCHIETTO, thoracic retractor	591	raspatory	782
MISKIMON, self, retaining laminectomy retractor	403	NIEDERDELLMANN, osteotomes	662
MITCHELLS, raspatory	626	NISSEN, delicate hemostatic forceps	222
MIXTER, dissecting and ligature forceps	243, 245, 475	dissecting and ligature forceps	244, 475
MIXTER-O'SHAUGHNESSY, dissecting and ligature forceps	240	NOON, ATRAUMATIC bulldog clamp	262
Micro dissectors	596, 761, 762	NORFLOK AND NORWICH, self, retaining laminectomy retractor	403
Micro forceps	98, 101, 838, 844	NORTHBENT, ligature scissors	78
Micro forceps, Titanium	128	NORTHFIELD, bone rongeur	712
Micro hooks	762	NOTO, organ and tissue forceps	142, 542
Micro ligature scissors	31	NOVAK-SCHOECKAERT, biopsy curette	550
Micro needle holders	162, 163	NOYES, eye scissors	29
Micro raspatory	762	NUSSBAUM, intestinal clamps	445
Micro ring forceps	101		
Micro scissors	28, 30-32, 844	O	
Micro scoops	762	O'CONNELL, dissector	617
Micro suture tying forceps	99, 101	O'SHAUGHNESSY, dissecting and ligature forceps	239, 240
Micro vascular scissors	66	O'SULLIVAN-O, CONNOER, abdominal retractors	426
Microscopic needles	845	Obstetric lever	569
Mini reamer	815	OBWEGESER, ligature needles	810
Mini screw holder	815	osteotome	662
Mirror	758	retractors	347
Mirror handle	6, 758	OCHSNER, ATRAUMATIC aorta clamp	277
MOLLISON, self, retaining retractors	397, 400	gall duct probe	478
MOLT, raspatory	620	ligature forceps	107
MORE, protheses extractor	821	OFFICER, tissue forceps	121
MORRIS, ATRAUMATIC sigmoid anastomosis forceps	73, 454	OLDBERG, rongeur	740
retractors	356	OLIVECRONA, bone rongeur	712
MORSE, sternum spreaders	586	brain spatulas	750
Mouth gags	3	trigeminal knife	17
MOYNIHAN, delicate hemostatic forceps	219	OLLIER, retractor, deep form	343
hemostatic forceps	232, 475	OMBREDANNE, mallet	672
MUHLING, bone shears	77		

Organ and tissue forceps	152, 541	Prostate retractor	377, 497
Osteotomes	656, 822	Protheses extractors	821
OVERHOLT, dissecting and ligature forceps	237	Protheses pusher	821
OVERHOL-MIXTER, dissecting and ligature forceps	236	PROVIDENCE, delicate hemostatic forceps	219
OVERHOLT-GIESSENDOERFER, dissecting and ligature forceps	236, 238	PUTTI, bone file and rasps	693
P			
PAPAVERO, bayonet chisel	779	Q	
PAPAVERO-CASPAR, hypophysectomy speculas	778	QUERVAIN, elevator	634
PAPAVERO-HARTMANN, speculum	778	QUINBY, delicate scissors	39
PARKER, retractors	336	R	
PARKS, anastomosis blade	467	R.N.O.H, bone biopsy trephine	812
rectal blades	467	RAABE, suction tubes	309
rectal retractors	467	RAGNEL, dissecting scissors	35
sphincter blade	467	retractor	335
PARRY, COOLEY, ATRAUMATIC anastomosis clamp	291	RAMPLEY, sponge and dressing forceps	140
PARTSCH, chisels	656	RAMSEY, dissecting forceps	107
gouges	657	tissue forceps	121
raspatories	620	RANDALL, biopsy curette	550
PASSOW, tampers	669	kidney stone forceps	492, 493
PAUL, retractor	333	RANEY, clip applicator	752
PAULSEN, raspatories	622	RANKIN, delicate hemostatic forceps	221
PAYR, guiding probes	202	Raspatories	615, 621, 623, 630, 631, 633, 761
intestinal clamps	447	RAY, curettes	784
pylorus clamp	447	Reamers	811, 823
PEAN, hemostatic forceps	226, 227, 229, 233, 486	Reamers and awls	811
tubing clamp	11	RECAIMER, uterine scoops	557
ATRAUMATIC hemostatic forceps	260	placenta and ovum curettes	559
PEDERSON, vaginal speculas	510	Rectal scissors	458
PELMANN, foreign body forceps	154, 482, 532	Rectal speculas	462
PENFIELD, dissectors	616, 618	REDON, guide needles	317
raspatory	615	REILL, micro needle holders	163, 844
PENNINGTON, intestinal grasping forceps	150	reposition forceps	696
raspatory	619	tendon strippers	826
PENNYBACKER, bone rongeur	712	wire cutter, with carbide cutting	807, 815
probe dissector	614	REIN-KUPKA, HARDMODEL needle holders	188
ronjur	736	REMINGTON-HOBB, electrosurgical instruments	854
raspatory	621	Removing the forceps screw	817
PERCY, amputation retractors	834	Reposition forceps	696, 697, 698, 700
Perforated trays	528	RESANO, cartilage scissors	57
Perforator	747	RESONE, ATRAUMATIC sigmoid anastomosis forceps	455
Periosteum knife	19, 830	Retractors	329, 346, 351, 365, 649-655, 845
PERKINS, self, retaining retractors	398	Retractor holder rod	771, 773
PERWITZCHIKY, delicate scissors	39	Retractor placing handle	414
Phalangeal knife	19, 830	Retractor, flexible arms	774
PHANEUF, peritoneum hysterectomy forceps	248	Retractor, holder for forceps	773
PICCOLO, cotton applicators	304	Retractor, holding and fixation attachments	770, 774
PIERCE, raspatory	619	Retractor, table fixation joints	771, 773
trocar	316	REVERDIN, abdominal and intestinal spatula	391
PIPER, obstetrical forceps	569	suture instruments, reverdin needles	193
PITHA, foreign body forceps	154, 502	REYNOLDS, dissecting scissors	49
Placenta and ovum forceps	574	REYNOLDS-JAMESON, vascular scissors	35
Plaster and cloth scissors	76, 795	RIBBON, abdominal and intestinal spatulas	391
Plaster cutting scissors	75, 794	RICHARD, abdominal retractors	421
Plaster spreaders	797	RICHARDSON, retractors	353, 354
Plate bending and contouring device	816	RICHARDSON-EASTMAN, retractors	354
Plate holding forceps	814	RICHES, electrosurgical forceps	855
PLESTER, self, retaining retractors	399, 400	RICHTER, punch	724
suction tubes	306	special retractor	408, 525
POIRIER, tissue grasping forceps	146	Rib shear	609, 835
POOL, suction cannulas	313	RNTNE, self, retaining retractor	398
Popliteal retractors	430	ROBERTS, hemostatic forceps	232, 233
POTTS, dissecting scissors	49	raspatory	627
POTTS-DE MARTEL, cardiovascular scissors	67, 68, 477	ROBIN, towel clamps	157
POTTS-SMITH, cardiovascular scissors	68	ROBIN-MASSE, abdominal retractors	421
scissors for vascular surger	71	ROCHARD, abdominal retractor fixation device	388
Pouch opener	565	abdominal retractors	388, 389, 488
POZZI, organ and tissue forceps	152, 153, 535, 541	ROCHESTER-CARMALT, hemostatic forceps	232
PRATT, rectal specula	463	ROCHESTER-OCHSNER, hemostatic forceps	230, 232
uterine dilators	526	ROCHESTER-PEAN, hemostatic forceps	228
PROB, guiding probe	201	ROEDER, towel clamp	156
Probes	300-302, 472, 827, 834		



ROGGE, sterilizing forceps	857	SCHWEDISCHES MODELL, dissecting forceps	107
ROLLET, skin retractors	322	SCOVILLE, self, retaining retractors	411, 412
Rongeurs	733, 742	SCOVILLE-HAVERFIELD, self, retaining retractor	412
ROSE, retractor	335	SCOVILLE-RICHTER, retractors	411
ROTUNDA, irrigation cannula	563	Screw extractor T arm	817
ROUX, retractors	336-338	Screwdrivers	414, 778, 790, 814
ROWBOTHAM, suction tube	312	Screwdrivers, T arm	817
RÖTTGEN-RUSKIN, bone rongeur	713	SCUDDER, stomach clamp	446
RUBIN, bone file and rasps	690	SEBILEAU, elevatör	634
RUDD, hemorrhoidal ligator	470	SEDILLOT, raspatories	625
Rulers	7	SEGOND, hysterectomy hemostatic forceps	250
RUMEL, dissecting and ligature forceps	241	SEGOND-LANDAU, hysterectomy hemostatic forceps	250
RUMEL-BELMONT, tourniquets	602	SEIDL, vaginal speculas	512
RUSKIN, bone rongeur	713	SEIDLDBP, biopsy forceps	551
RUSKIN-LISTON, bone cutting forceps	719	SEIFFERT, probe	302
RUSS MODELL, tissue forceps	121	SELDIN, raspatories	627
RUST, amputation saws	833	Self, retaining laminectomy retractors	407
amputation saw blades	833	Self, retaining retractors	394, 395, 413- 417, 790
amputation saw handle	833	Self, retaining retractors, Titanium	416
RYDER, DIAPOWDER micro needle holders	165, 166	Self, retaining retractor, Titanium blades	417, 790, 791
HARDMODEL needle holder	186, 187	SELLORS, rib spreader	608
S			
SAALFELD, comedone extractor	840	SELMAN, tissue forceps	121
SACHS, raspatory	615	SEMB, bone holding forceps	608, 699, 835
SAENGER, placenta and ovum forceps	573	bone rongeur	611, 716
SAMI, tumor tissue knives	765, 766	raspatories	596, 597, 627
SAROT, delicate hemostatic forceps	224	SEMKEN, delicate dissecting forceps	103
HARDMODEL needle holders	178	tissue forceps	116
hemostatic forceps	233	SEMM, abdominal retractors	428
SATINSKY, ATRAUMATIC bulldog clamp	287	vaginal speculas	511
scissors for vascular surge	71	SENN-MILLER, retractor	332
SAUER, self, retaining retractor	394	Sequestrum forceps	698
SAUERBRUCH, lung spatula	364	SEWALL, raspatory	615
pick, up forceps	11	SEYFFERT, vaginal speculas	511
retractors	348	SIEBOLD, uterine scissors	61
rib shears	609	SILVER, skin graft knife	20, 841
SAUERBRUCH-CORYLLOS, bone rongeurs	611, 717	SIMON, bone curettes	683, 688
SAUNDERS, biopsy curette	550	retractors	330, 360, 521
Scalpel handles	22-24, 499, 546	uterine scoops	556, 568
Scalpel handle, for microsurgery blades	767	SIMPSON, uterine probe	530
Scalpels	14, 15	SIMPSON-BRAUN, obstetrical forceps	568
SCHADEL, towel clamps	155	SIMS, gynecology scissors	63, 65
SCHAMBERG, curette	840	HARDMODEL uterine scissors	83
SCHUDE, bone curettes	678	HARDMODEL uterine scissors, PerfectCut	90
SCHERBACK, vaginal specula, handle	524	rectal speculas	462-464
vaginal speculums	524	uterine probes	530
SCHINDLER, hysterectomy hemostatic forceps	251	uterine scoops	558
SCHINIC, dermatomes	20, 841	vaginal speculas	516
SCHMID, dissectors	596	Silicon divider	527
mouth gag	3	Sliding rails for dividers	527
vessel irrigating cannulas	603	Skin graft knife	20, 841
SCHMIEDEN, guiding probe	201	Skin straightening plate	20, 841
SCHMIEDEN-TAYLOR, dura scissors	69	SIMS-SIEBOLD, uterine scissors	58, 64
SCHNEIDER, raspatory	625	SMELLIE, placenta and ovum forceps	575
SCHNEIDER-SAUERBRUCH, raspatory	625	SMILLE, retractors	350, 819
SCHNIDT, hemostatic forceps	234	meniscus knives	818
SCHOEMAKER, colectomy	446	SMITH-BUIE, rectal retractor	467
SCHOENBORN, wound and vein retractor	331	SMITH-PETERSEN, gouges	661
SCHRÖDER, bone curettes	556, 688	osteotomes	661
organ and tissue forceps	151, 153, 535, 541	SOMER, uterine elevating forceps	544
uterine tenaculum forceps	535, 540	SPACKMAN, vulsillum cannula	563
SCHUBER, biopsy forceps	551	Spare blade	20, 841
SCHUKNECHT, suction tubes	308	Spatula	304
SCHULZ, bioptome	604	SPENCER, ligature scissors	78
retractors	349	SPENCER-WELLS, hemostatic forceps	227
SCHULZE, uterine cannula	562	Spermatic cord fixation clamp	500
SCHUMACHER, biopsy forceps	551, 553, 555	Splinter forceps	123, 839
bone lever	643	Sponge and dressing forceps	134, 137
sternum scissors	606	Sponge forceps	9, 138
umbilical cord scissors	72, 566	Spring hooks	753, 774
SCHUMACHER-WAGNER, bone lever	643	SPURLING, rongeurs	739
		ST.BARTS, nerve and vessel hook	320
		rongeurs	735, 736

- ST.MARKS**, pelvis retractors 384, 461
ST.MARKS-GIRONA, perineal retractor 467
ST.MARTIN, delicate eye forceps 114
STAMM, bone cutting forceps 718
STAUSS, penis clamp 501
STELLBRINK, synovectomy rongeurs 708
STELZNER, rectal scissors 58, 457
Sterile containers 528
Sterile storage of dilators 527
Sterilizing forceps 857
STERNBERG, retractors 339
Sternum retractors 588
STEVENS, delicate dissecting scissors
dissecting scissors 34
vascular and tendon scissors 48
STIEGLITZ, splinter forceps 123, 839
STILLE, bone rongeur 714
chisels 660
dissecting scissors 54
gouges 660
kidney clamps 488
osteotomes 660, 835
plaster scissors 796
STILLE-BARRAYA, vascular and tumor forceps 120
STILLE-RUSKIN, bone rongeur 715
STOCKMANN, penis clamp 501
STRANDELL-STILLE, retractors 329
STRASSBURGER, tissue forceps 118
STRATTE, HARDMODEL needle holders 183
STRUCK, rib retractors 580
STRULLY, dura scissors 69
vascular scissors 69, 477
SUBRAMANIAN, ATRAUMATIC aorta clamp 278
Suction cannulas 313
Suction handle 313
Suction tubes 307, 309-313
SUETIN, bandage scissors 76, 794
Superficial dissecting scissors 92
Surgical scissors 41-44
Suture forceps 121, 125
Suture instrument, ligature needles 198, 810
SWEDISH, dissectors 614
SWEET, bone punches 748
SYME, raspatory 616
Synovectomy rongeur 708
SYPERT, bone curettes 687
bone rongeur 717
punch 724
rongeur 742
tampers 669
SYSTRUNK, surgical scissors 45, 825
- T**
- TAGER**, bone lever 647
Tampers 669
TARNIER, obstetrical forceps 570
TAYLOR, retractors 410, 648
self, retaining retractors 412
TEALE, uterine tenaculum forceps 538, 540
Tendon interlaction forceps 144, 825
Tendon strippers 826, 827
THOMS-GAYLOR, biopsy forceps 551
Thoracic retractors 588, 590
THOREK, scissors for vascular surgery 71
THORPE, corneal forceps 102
Thyroid retractor 409
TISCHLER, biopsy forceps 555
Tissue forceps 116-119, 129, 834, 838
Tongue depressors 2, 4
Tourniquets 602
Towel clamps 155, 157-159, 857
TÖNNIS, dissecting scissors 51
dissectors 596, 618
dura retractor 323
grooved dissector 618
HARDMODEL needle holder 189
needle holder 175
TÖNNIS-ADSON, dissecting scissors 50
HARDMODEL dissecting scissors 87
HARDMODEL dissecting scissors, PerfectCut 90
TÖNNIS-MODIF, HARDMODEL needle holder 189
Traction hooks 799
Traction instruments 746, 798, 799
Traction instrument, drill points 746
Traction instrument, fixation discs 799
Traction instrument, screw 798
Traction wrench 799
TRAVERS, laminectomy retractor 401
Tray for instrument 774
TRELAT, raspatory 621
vaginal speculas 508
TREVES, tissue forceps 118
Trigeminal knife 17
Trocars 313, 316
TROELTSCH, angular forceps 113
TROTTER, bone rongeur 712
TROUSSEAU, thyroid dilator 409
Tubing clamps 10, 11
TUDOR-EDWARDS, abdominal retractor 381
TUFFIER, abdominal and intestinal spatula 390
abdominal retractor 381
artery traction forceps 146
rib retractors 581
Tunneling tubes with conical tip 605
TURANTAN, self, retaining retractors 410
TURNER WARWICK, retrograde bougie 505
abdominal retractors 427, 428
TUTTLE, lung grasping forceps 122
TÜBINGER, gall duct forceps 483
TÜBINGER, retractor 360, 521
TÜBINGER, self, retaining retractor 400
- U**
- UCHIDA**, radical hysterectomy instruments 547, 548
UFFENORDE, bone curette 683
ULRICH, fistula knife 16
sponge and dressing forceps 137
Umbilical cord scissors 72, 566
Umbilical dilator 567
UNNA, curette 840
Ureter forceps 500
Urethral retractor 377
US, ARMY, retractor 339
Uterine probes 502
Uterine tenaculum forceps 536
- V**
- Vacuum curettes 315, 561
Vaginal speculas 517
VALLEIX, uterine probe 531
Valve retractors 589
VANNAS, micro scissors 28-30, 844
VARADY, varix instrument 599
Vascular scissors 70, 477
Vascular and neurosurgery scissors 69
Vein scissors 29
Venous plexus clamp 498
VERBRUGGE, bone holding forceps 705
VERBRUGGE-MÜLLER, bone levers 641
VERHOEVEN, suction tubes 306
VIDAL, lupus scraper 840
VISE, micro suture tying forceps 99
VOLKMANN, bone curettes 676, 679
bone retractors 341



retractors	340, 341	Wire holding forceps	803, 804
W		Wire tightener	799
WACHTEL, DIAPOWDER micro dissecting forceps	127	Wire twisters	803
DIAPOWDER micro tissue forceps	127	WOLFF, curettes	840
HARDMODEL micro needle holder	164	plaster breakers	797
WAGENER, nerve and vessel hooks	320	Wooden mouth gag	3
WAGNER, bone lever	637	WOODSON, raspatory	617
gouges	666	wound and trached retractors	325, 326, 500
mallet	671	wound and vein retractors	331, 333
mallet disc, metal	671	WÖRRLEIN, reposition tamper	698
mallet disc, plastic	671	Wrenches	671, 746
raspatories	633	WRIGLEY, obstetrical forceps	569
rongeurs	742, 743	WULLSTEIN, self, retaining retractors	398
bone level	635	suction tubes	307, 308
wire extension	810	Y	
WALLICH, placenta and ovum curette	560	YANKAUER, suction cannula	314, 607
WALTER, gouges	660	suction tube	314
osteotomes	659	YASARGIL, canulla	311
WALTON, biopsy forceps	469	clip applicators	768
WANGENSTEEN, HARDMODEL dissecting forceps	125	clip applicators, Titanium	769
HARDMODEL needle holder	184	dissectors	759
needle holder	173	forceps for grasping tumor, tissue	110, 111
WARD, raspatory	620	micro dissectors	763
WATSON-CHEYNE, raspatories	616	micro needle holder	162
WATSON-JONES, bone lever	638	micro raspatories	763
WAUGH, delicate tissue forceps	120	micro scissors	30
WEBER, ATRAUMATIC aorta anastomosis clamps	279	micro scoop	763
WEBSTER, HARDMODEL needle holder	176	micro vessel knives	764
needle holder	170	movable micro mirror	758
WECKER, Iridectomy scissors	29	rongeurs	740
WEIL-BLAKESLEY, rongeurs	735	spring hooks	753
WEISSBARTH, vaginal speculas	523	suction tubes	312
WEITLANER, self, retaining retractors	396, 397, 401, 402, 845	LEYLA retractors	770
Weights	798	LEYLA retractor, coupling head	771
Weight with chain	821	LEYLA retractor, fixation attachments	771
WELLER, dissecting scissors	57	LEYLA retractor, fixation bases	770
menisküs pensi	818	LEYLA retractor, flexible arms	770
WERTHEIM, ATRAUMATIC hysterectomy forceps	252	YEOMAN, biopsy forceps	468
compression forceps	256, 490	YOUNG, prostate retractors	497
gynecology scissors	65	YOUNG-HRYNTSCHAK, boomerang needle holder	192, 499
HARDMODEL dissecting scissors	83	Z	
HARDMODEL needle holders	183	ZENKER, dissecting and ligature forceps	242
hysterectomy forceps	254, 489	retractors	361
hysterectomy hemostatic forceps	249, 250	ZIELKE, gouges	664
WERTHEIM-CULLEN, compression forceps	490	ZOELLNER, suction tubes	306, 308
WIENER MODELL, peritonom hysterectomy forceps	248	ZUFAL-JANSEN, bone rongeur	713
WIKSROEM, dissecting and ligature forceps	240	ZWEIFEL, HARDMODEL needle holders	191
WILDE, angular forceps	113		
WILLETT, scalp flap forceps	571		
WILLIAMS, organ forceps	141		
WILLIGER, bone curettes	676, 679		
elevators	634		
raspatories	620		
retractors	332		
WILSON, hemostatic forceps	234		
organ and tissue forceps	153, 534		
WILSON-HEY, electrosurgical forceps	855		
WINKELMANN, circumcision clamps	501		
WINTER, placenta and ovum forceps	572		
WITT, sternal puncture needles	606		
Wire and screw cutting pliers	809		
Wire bases	528		
Wire bending pliers	804		
Wire cutter	806		
Wire cutters, with carbide cutting	807		
Wire cutter, with carbide cutting edges	806		
Wire cutting forceps	805, 806, 808		
Wire cutting scissors	79, 805		
Wire guides	800		
Wire holding forceps	803, 815		
Wire holding forceps, with carb cut edge	802		

0-9

SAYISAL İNDEKS
NUMERICAL INDEX



Kat. No. Cat. No.	Sayfa Page	Kat. No. Cat. No.	Sayfa Page	Kat. No. Cat. No.	Sayfa Page	Kat. No. Cat. No.	Sayfa Page
AA-2006	6	BB-1322	764	BB-2160	19, 830	BC-1704	33
AA-2008	6	BB-1323	764	BB-2165	19, 830	BC-1705	33
AA-2010	6	BB-1324	764	BB-2170	831	BC-1706	33
AA-2012	6	BB-1325	764	BB-2175	795	BC-1825	32
AA-2014	6	BB-1330	764	BB-2300	20, 841	BC-1845	32
AA-2016	6	BB-1335	764	BB-2305	20, 841	BC-1860	32
AA-2018	6	BB-1340	764	BB-2310	20, 841	BC-1890	32
AA-2020	6	BB-1410	765	BB-2315	21	BC-1895	32
AA-2022	6	BB-1415	765	BB-2325	20, 841	BC-1896	30
AA-2024	6	BB-1420	765	BB-2330	21	BC-1897	30
AA-2026	6	BB-1425	765	BB-2335	20, 841	BC-1925	32
AA-2028	6	BB-1430	765	BB-2340	20, 841	BC-1945	32
AA-2030	6	BB-1435	765	BB-2350	21	BC-1960	32
AA-2106	6	BB-1440	765	BB-2400	838	BC-1990	32
AA-2108	6	BB-1450	765	BB-2402	838	BC-1995	32
AA-2110	6	BB-1510	765	BB-2403	838	BC-1996	30
AA-2112	6	BB-1515	765	BB-2404	838	BC-1997	30
AA-2114	6	BB-1520	765	BB-2406	838	BC-2025	32
AA-2116	6	BB-1525	765	BB-2407	838	BC-2045	32
AA-2118	6	BB-1530	765	BB-2500	840	BC-2060	32
AA-2120	6	BB-1535	765	BB-2510	840	BC-2090	32
AA-2122	6	BB-1540	765	BB-2520	840	BC-2095	32
AA-2124	6	BB-1550	765	BB-2615	845	BC-2125	32
AA-2126	6	BB-1615	766	BB-2620	845	BC-2145	32
AA-2128	6	BB-1630	766	BB-3110	818	BC-2160	32
AA-2130	6	BB-1645	766	BB-3115	818	BC-2190	32
AA-2140	6	BB-1660	766	BB-3120	818	BC-2195	32
AA-2150	6	BB-1718	766	BB-3400	565	BC-2225	32
AA-2152	6	BB-1725	766			BC-2245	32
AA-2154	6	BB-1801	767			BC-2260	32
AA-2170	758	BB-1802	767	BC-1100	29	BC-2290	32
AA-2180	758	BB-1900	15	BC-1105	29	BC-2295	32
AA-2210	7	BB-1901	15	BC-1110	29	BC-2296	31
AA-2215	7	BB-1902	15	BC-1115	29	BC-2325	32
AA-2220	7	BB-1903	15	BC-1120	29	BC-2345	32
AA-2230	7	BB-1904	15	BC-1125	29	BC-2360	32
AA-2250	7	BB-1905	15	BC-1130	28, 844	BC-2390	32
AA-2265	7	BB-1906	15	BC-1135	28	BC-2395	32
AA-2272	7	BB-1907	15	BC-1140	28	BC-2396	31
AA-2273	7	BB-1908	15	BC-1145	28	BC-2397	31
AA-2460	7	BB-1909	15	BC-1150	29	BC-2425	32
AA-2472	564	BB-1910	14	BC-1155	29	BC-2445	32
AA-2473	564	BB-1911	14	BC-1325	28	BC-2460	32
		BB-1912	14	BC-1330	28	BC-2490	32
		BB-1913	14	BC-1335	28	BC-2495	32
BB-1100	24	BB-1914	14	BC-1340	28, 844	BC-2525	32
BB-1101	24	BB-1915	14	BC-1350	28	BC-2545	32
BB-1102	24	BB-1920	14	BC-1351	28	BC-2560	32
BB-1103	24	BB-1925	831	BC-1352	29	BC-2590	32
BB-1104	24	BB-1930	16	BC-1355	29	BC-2595	32
BB-1105	767	BB-1935	17	BC-1360	29	BC-2900	4
BB-1106	25	BB-1960	16	BC-1365	30	BC-2901	4
BB-1107	25	BB-1961	16	BC-1370	30	BC-2902	4
BB-1110	22	BB-1962	16	BC-1380	30	BC-2903	4, 78
BB-1112	22	BB-1970	17	BC-1381	30	BC-2904	4, 78
BB-1115	23	BB-1975	17	BC-1390	30	BC-2905	4, 78
BB-1117	22	BB-2000	17	BC-1391	30	BC-2906	5
BB-1118	23	BB-2004	16	BC-1395	30	BC-2907	5
BB-1120	23, 546	BB-2005	16	BC-1396	30	BC-2908	5
BB-1121	22, 499	BB-2006	16	BC-1610	31	BC-2909	5
BB-1122	22, 499	BB-2111	18, 830	BC-1611	31	BC-2910	36
BB-1125	22	BB-2112	18, 830	BC-1612	31	BC-2911	36
BB-1210	22	BB-2120	19, 830	BC-1631	31	BC-2912	4, 36
BB-1212	22	BB-2125	18, 831	BC-1632	31	BC-2913	36
BB-1215	23	BB-2130	18, 830	BC-1635	31	BC-2914	4, 36
BB-1218	23	BB-2135	18, 830	BC-1640	31	BC-2915	36
BB-1223	23	BB-2140	18, 830	BC-1700	33	BC-2916	46
BB-1224	23	BB-2145	18, 830	BC-1701	33	BC-2917	34
BB-1320	764	BB-2150	831	BC-1702	33	BC-2918	34
BB-1321	764	BB-2155	19, 830	BC-1703	33	BC-2919	36

Kat. No. Cat. No.	Sayfa Page	Kat. No. Cat. No.	Sayfa Page	Kat. No. Cat. No.	Sayfa Page	Kat. No. Cat. No.	Sayfa Page
BC-2920	36	BC-3614	44	BC-4150	57	BC-4712	68, 477
BC-2921	34	BC-3713	44	BC-4160	51	BC-4825	66
BC-2922	34	BC-3714	44	BC-4161	51	BC-4845	66
BC-2923	37	BC-3800	44	BC-4162	51	BC-4860	66
BC-2925	37	BC-3801	44	BC-4165	51	BC-4890	66
BC-2926	37	BC-3810	45	BC-4214	56	BC-4895	66
BC-2929	37	BC-3811	45	BC-4215	56	BC-4925	66
BC-2930	37	BC-3812	45	BC-4217	56	BC-4945	66
BC-2931	37	BC-3813	45	BC-4314	56	BC-4960	66
BC-2932	37	BC-3814	45	BC-4315	56	BC-4990	66
BC-2933	37	BC-3816	45	BC-4317	56	BC-4995	66
BC-2934	37	BC-3825	46	BC-4414	56	BC-5025	66
BC-2935	38	BC-3830	46	BC-4417	56	BC-5045	66
BC-2936	38	BC-3831	46	BC-4514	56	BC-5060	66
BC-2937	38	BC-3835	46	BC-4517	56	BC-5090	66
BC-2938	38	BC-3840	47	BC-4525	54	BC-5095	66
BC-2939	38	BC-3845	47	BC-4526	54	BC-5145	68
BC-2940	38	BC-3850	46	BC-4534	53	BC-5155	68
BC-2941	38	BC-3855	47	BC-4537	53	BC-5160	68
BC-2942	38	BC-3860	47	BC-4544	53	BC-5200	74
BC-2943	34	BC-3865	49	BC-4547	53	BC-5201	74
BC-2944	38	BC-3870	49	BC-4550	54	BC-5202	74
BC-2945	34	BC-3871	49	BC-4559	53	BC-5203	74
BC-2946	38	BC-3875	35	BC-4561	53	BC-5204	74
BC-2947	38	BC-3876	49	BC-4569	53	BC-5205	74
BC-2948	49	BC-3877	49	BC-4571	53	BC-5206	74
BC-2949	35	BC-3882	48	BC-4575	54	BC-5207	74
BC-2950	39	BC-3883	34	BC-4576	54	BC-5208	75
BC-2951	39	BC-3884	48	BC-4577	54	BC-5209	75, 794
BC-2952	39	BC-3885	34	BC-4578	55	BC-5210	76
BC-2953	47	BC-3886	48	BC-4579	55	BC-5211	73
BC-2954	47	BC-3887	34	BC-4580	55	BC-5212	76, 794
BC-2955	47	BC-3888	48	BC-4581	55	BC-5213	78
BC-3010	41	BC-3889	34	BC-4586	55	BC-5300	69
BC-3011	41	BC-3890	48	BC-4587	55	BC-5301	70, 498
BC-3013	41	BC-3891	48	BC-4588	55	BC-5302	39
BC-3014	41	BC-3892	48	BC-4589	55	BC-5303	39
BC-3015	41	BC-3893	48	BC-4590	55	BC-5304	69, 477
BC-3016	41	BC-3894	48	BC-4600	62	BC-5305	69
BC-3017	41	BC-3895	35	BC-4601	62	BC-5306	69
BC-3018	41	BC-3896	35	BC-4602	62	BC-5307	69
BC-3020	41	BC-3897	35	BC-4603	62	BC-5308	70, 477
BC-3111	41	BC-3900	50	BC-4610	63	BC-5310	40
BC-3113	41	BC-3901	50	BC-4611	63	BC-5311	40
BC-3114	41	BC-3902	50	BC-4612	63	BC-5312	40
BC-3115	41	BC-3903	35	BC-4613	63	BC-5313	39
BC-3116	41	BC-3904	50	BC-4614	63	BC-5314	40
BC-3117	41	BC-3905	35	BC-4615	63	BC-5315	40
BC-3118	41	BC-3906	50	BC-4616	63	BC-5327	70
BC-3213	42	BC-3907	50	BC-4617	63	BC-5328	71
BC-3214	42	BC-3908	49	BC-4620	65	BC-5329	71
BC-3215	42	BC-3910	50	BC-4621	65	BC-5330	78
BC-3216	42	BC-3911	50	BC-4622	65	BC-5335	78
BC-3217	42	BC-3913	51	BC-4630	65	BC-5340	78
BC-3311	42	BC-3914	51	BC-4631	65	BC-5345	75, 794
BC-3313	42	BC-3915	51	BC-4632	61	BC-5350	75, 794
BC-3314	42	BC-4014	52	BC-4633	61	BC-5355	75, 794
BC-3315	42	BC-4018	52	BC-4634	58, 64	BC-5360	76, 795
BC-3316	42	BC-4020	52	BC-4700	67	BC-5365	76, 795
BC-3317	42	BC-4023	52	BC-4701	67	BC-5370	45, 825
BC-3411	43	BC-4025	52	BC-4702	67	BC-5380	79
BC-3413	43	BC-4028	52	BC-4703	67	BC-5381	79
BC-3414	43	BC-4030	52	BC-4704	67	BC-5382	79
BC-3415	43	BC-4114	52	BC-4705	67	BC-5383	79
BC-3416	43	BC-4118	52	BC-4706	67	BC-5385	79, 805
BC-3511	43	BC-4120	52	BC-4707	67	BC-5390	79, 805
BC-3513	43	BC-4123	52	BC-4708	67	BC-5391	835
BC-3514	43	BC-4125	52	BC-4709	67	BC-5392	835
BC-3515	43	BC-4128	52	BC-4710	68	BC-5393	77
BC-3613	44	BC-4130	52	BC-4711	68, 477	BC-5394	77



Kat. No. Cat. No.	Sayfa Page	Kat. No. Cat. No.	Sayfa Page	Kat. No. Cat. No.	Sayfa Page	Kat. No. Cat. No.	Sayfa Page
BC-5395	80	BC-5821	90			BD-1422	111
BC-5396	80	BC-5825	87			BD-1425	111
BC-5397	89	BC-5826	90	BD-1100	114	BD-1430	111
BC-5400	58, 457	BC-5923	86	BD-1101	114	BD-1453	111
BC-5401	71	BC-5924	86	BD-1102	114	BD-1454	111
BC-5402	71	BC-5925	91	BD-1103	98, 838, 844	BD-1455	111
BC-5403	59	BC-5930	86	BD-1104	128	BD-1456	111
BC-5404	58, 457	BC-6018	87	BD-1105	98	BD-1466	111
BC-5405	58	BC-6020	87	BD-1106	98, 838	BD-1467	111
BC-5406	59, 458	BC-6023	87	BD-1107	128	BD-1476	101
BC-5407	458	BC-6118	87	BD-1108	98	BD-1480	101
BC-5408	72, 566	BC-6119	91	BD-1109	98	BD-1483	101
BC-5409	72, 566	BC-6120	87	BD-1110	99	BD-1485	102
BC-5410	72, 566	BC-6121	91	BD-1111	98, 844	BD-1500	102
BC-5411	72, 566	BC-6123	87	BD-1112	98	BD-1501	128
BC-5412	73, 567	BC-6124	91	BD-1113	99	BD-1505	102
BC-5413	73, 567, 606	BC-6125	86	BD-1114	99	BD-1510	102
BC-5414	73, 567	BC-6126	91	BD-1121	100	BD-1512	103
BC-5415	64	BC-6130	86	BD-1122	100	BD-1513	103
BC-5416	64	BC-6135	91	BD-1123	100	BD-1514	103
BC-5417	60, 548	BC-6140	86	BD-1124	100	BD-1518	102
BC-5418	60, 548	BC-6145	91	BD-1125	100	BD-1519	102
BC-5419	60, 548	BC-6160	86	BD-1126	100	BD-1609	103
BC-5420	60, 548	BC-6165	91	BD-1127	100	BD-1610	103
BC-5500	835	BC-6170	87	BD-1128	100	BD-1611	103
BC-5501	835	BC-6200	88	BD-1129	100	BD-1613	103
BC-5502	57	BC-6201	94	BD-1130	100	BD-1614	103
BC-5503	80	BC-6202	88	BD-1135	99	BD-1709	103
BC-5504	80	BC-6203	88	BD-1140	99	BD-1710	103
BC-5505	80	BC-6204	88	BD-1145	99	BD-1711	103
BC-5510	80	BC-6205	88	BD-1150	99	BD-1713	103
BC-5511	80	BC-6206	94	BD-1180	99	BD-1714	103
BC-5512	81	BC-6314	94	BD-1212	101	BD-1720	103
BC-5513	81	BC-6318	94	BD-1215	101	BD-1812	103
BC-5514	89	BC-6320	94	BD-1218	101	BD-1815	103
BC-5515	81	BC-6418	94	BD-1312	101	BD-1820	104, 838
BC-5517	81	BC-6420	94	BD-1315	101	BD-1900	104
BC-5615	81	BC-6516	94	BD-1318	101	BD-1901	130
BC-5617	81	BC-6517	94	BD-1320	101	BD-1902	838
BC-5618	89	BC-6522	84, 477	BD-1325	101	BD-1903	130
BC-5621	82	BC-6611	95	BD-1330	101	BD-1904	104
BC-5623	82	BC-6615	95	BD-1350	112	BD-1905	104
BC-5631	82	BC-6714	95	BD-1355	112	BD-1910	105
BC-5633	82	BC-6718	95	BD-1360	112	BD-1920	104
BC-5635	82	BC-6720	95	BD-1370	112	BD-1921	130
BC-5636	89	BC-6818	95	BD-1375	112	BD-1922	104
BC-5640	82	BC-6820	95	BD-1380	112	BD-1923	130
BC-5641	89	BC-6900	95	BD-1385	112	BD-2011	106
BC-5645	83	BC-6901	95	BD-1395	112	BD-2013	106
BC-5650	83	BC-7015	84, 805	BD-1400	112	BD-2014	106
BC-5655	83	BC-7110	92	BD-1401	112	BD-2015	130
BC-5656	90	BC-7111	92	BD-1403	113	BD-2016	106
BC-5657	83	BC-7115	92	BD-1404	113	BD-2017	130
BC-5658	90	BC-7116	92	BD-1405	113	BD-2018	106
BC-5659	83	BC-7120	92	BD-1406	113	BD-2020	106
BC-5660	84	BC-7121	92	BD-1407	113	BD-2025	106
BC-5661	84	BC-7130	93	BD-1408	113	BD-2030	106
BC-5665	85	BC-7131	93	BD-1409	113	BD-2113	107
BC-5666	85	BC-7214	92	BD-1410	110	BD-2114	107
BC-5667	90	BC-7215	92	BD-1411	110	BD-2115	104
BC-5670	85	BC-7400	93	BD-1412	110	BD-2116	105
BC-5671	85	BC-7401	93	BD-1413	110	BD-2200	104
BC-5672	90	BC-7410	93	BD-1414	110	BD-2201	104
BC-5714	85	BC-7411	93	BD-1415	110	BD-2202	104
BC-5718	85	BC-7501	796	BD-1416	110	BD-2205	105
BC-5814	85	BC-7502	796	BD-1417	110	BD-2210	105
BC-5815	90	BC-7503	796	BD-1418	110	BD-2215	105
BC-5818	85	BC-7504	796	BD-1419	111	BD-2220	105
BC-5819	90			BD-1420	111	BD-2225	105
BC-5820	85			BD-1421	111	BD-2230	105

Kat. No. Cat. No.	Sayfa Page	Kat. No. Cat. No.	Sayfa Page	Kat. No. Cat. No.	Sayfa Page	Kat. No. Cat. No.	Sayfa Page
BD-2311	106	BD-4801	116	BD-5516	119	BD-8415	126
BD-2313	106	BD-4802	116	BD-5520	119	BD-8418	126
BD-2314	106	BD-4803	116	BD-5550	122	BD-8421	126
BD-2316	106, 834	BD-4804	116	BD-5554	119	BD-8423	126
BD-2318	106, 834	BD-4805	116	BD-5560	122	BD-8425	126
BD-2320	106, 834	BD-4810	116	BD-5565	119	BD-8430	126
BD-2325	106	BD-4811	116	BD-5570	119	BD-8515	126
BD-2330	106	BD-4812	116	BD-5575	120	BD-8518	126
BD-2335	107	BD-4813	116	BD-5576	120	BD-8521	126
BD-2411	130	BD-4814	116	BD-5577	120	BD-8523	126
BD-2413	130	BD-4820	114	BD-5578	120	BD-8525	126
BD-2414	130	BD-4825	114	BD-5580	121	BD-8618	128
BD-2416	130	BD-4830	114	BD-5581	121	BD-8621	128
BD-2420	130	BD-4835	129	BD-5585	118	BD-8623	128
BD-2513	107	BD-4850	114, 838	BD-5586	118	BD-8625	416
BD-2515	107	BD-4851	129	BD-5590	120	BD-8718	128
BD-2517	107	BD-4855	114	BD-5591	120	BD-8721	128
BD-2518	107	BD-4856	129	BD-5592	120	BD-8723	128
BD-2520	107	BD-4860	115	BD-5593	120	BD-8818	126
BD-2540	107	BD-4861	115	BD-5594	120	BD-8822	126
BD-2545	107	BD-4862	115	BD-5615	118	BD-8918	126
BD-2550	98, 844	BD-4863	115	BD-5620	118	BD-8920	126
BD-2551	98, 844	BD-4865	114	BD-5715	120	BD-9018	127
BD-2552	98, 844	BD-4866	114	BD-5720	120	BD-9021	127
BD-2618	108	BD-4867	115	BD-5725	120	BD-9115	127
BD-2620	108	BD-4868	115	BD-5815	120	BD-9118	127
BD-2718	108	BD-4869	115	BD-5820	120	BD-9121	127
BD-2721	108	BD-4870	115	BD-5915	121	BD-9125	127
BD-2818	128	BD-4875	115	BD-5920	121	BD-9215	127
BD-2821	128	BD-4885	115	BD-5925	121	BD-9218	127
BD-2823	128	BD-4900	115	BD-6015	121	BD-9221	127
BD-3118	108	BD-5010	117	BD-6100	122	BD-9225	127
BD-3121	108	BD-5011	117	BD-6101	122	BD-9318	127
BD-3215	108	BD-5013	117	BD-6102	121	BD-9400	127
BD-3220	108	BD-5014	117	BD-6103	122	BD-9401	127
BD-3224	108	BD-5016	117, 834	BD-6104	122	BD-9402	127
BD-3230	108	BD-5018	117, 834	BD-6105	123, 839	BD-9403	127
BD-3415	131	BD-5020	117, 834	BD-6106	123, 839	BD-9500	127
BD-3420	131	BD-5025	117	BD-6107	123, 839	BD-9501	127
BD-3515	108	BD-5030	117	BD-6108	123, 839	BD-9600	127
BD-3519	108	BD-5035	117	BD-6109	123, 839	BD-9601	127
BD-3524	108	BD-5113	129	BD-6110	123, 839		
BD-3615	109	BD-5114	129	BD-6111	123, 839		
BD-3620	109	BD-5116	129	BD-6112	123, 839	BE-1100	134
BD-3624	109	BD-5118	129	BD-6205	124	BE-1113	134
BD-3630	109	BD-5120	129	BD-6314	124	BE-1116	134
BD-3715	131	BD-5211	117	BD-6318	124	BE-1117	134
BD-3720	131	BD-5213	117	BD-6320	124	BE-1214	134
BD-3815	109	BD-5214	117	BD-6323	124	BE-1314	134
BD-3820	109	BD-5216	117	BD-6325	124	BE-1618	134
BD-3824	109	BD-5218	117	BD-6418	125	BE-1718	134
BD-3830	109	BD-5220	117	BD-6421	125	BE-1800	134
BD-3915	131	BD-5225	117	BD-6514	124	BE-1900	9, 135
BD-3920	131	BD-5230	117	BD-6520	124	BE-1901	9, 135
BD-4115	109	BD-5300	117	BD-6528	124	BE-1902	9, 135
BD-4120	109	BD-5301	118, 838	BD-6614	125	BE-1903	9, 135
BD-4124	109	BD-5302	118, 838	BD-6616	125	BE-1905	135
BD-4130	109	BD-5303	119	BD-6618	125	BE-1910	135
BD-4215	131	BD-5310	118	BD-6700	125	BE-2015	8
BD-4220	131	BD-5311	118	BD-6815	125	BE-2020	8
BD-4420	109	BD-5312	118	BD-6823	125	BE-2025	8
BD-4424	109	BD-5318	118	BD-6850	125	BE-2100	9, 138
BD-4430	109	BD-5320	118	BD-7050	121	BE-2101	9, 138
BD-4435	109, 459	BD-5321	118	BD-8090	431	BE-2200	9, 138
BD-4515	108	BD-5413	119	BD-8118	126	BE-2201	9, 138
BD-4519	108	BD-5414	119	BD-8121	125	BE-2202	137
BD-4524	108	BD-5416	119	BD-8218	125	BE-2300	136
BD-4615	108	BD-5418	119	BD-8221	125	BE-2301	136
BD-4750	122	BD-5420	119	BD-8318	125	BE-2302	136
BD-4800	116	BD-5514	119	BD-8321	125	BE-2303	136



Kat. No. Cat. No.	Sayfa Page	Kat. No. Cat. No.	Sayfa Page	Kat. No. Cat. No.	Sayfa Page	Kat. No. Cat. No.	Sayfa Page
BE-2310	137	BE-3010	8, 141	BE-3909	156	BE-5102	572
BE-2311	137	BE-3011	8, 141	BE-3911	156	BE-5201	572
BE-2320	137	BE-3012	141	BE-3913	156	BE-5202	572
BE-2321	137	BE-3015	474, 543	BE-4008	156	BE-5203	572
BE-2322	137	BE-3020	142, 474, 542	BE-4010	156	BE-5301	572
BE-2335	139	BE-3030	151, 539	BE-4013	156	BE-5302	572
BE-2340	139	BE-3031	151, 539	BE-4100	157	BE-5400	574
BE-2345	139	BE-3035	151, 539	BE-4101	157	BE-5401	573
BE-2350	140	BE-3040	151, 540	BE-4102	156	BE-5402	573
BE-2351	140	BE-3045	151, 541	BE-4103	534	BE-5403	573
BE-2400	140	BE-3050	152, 541	BE-4104	156, 534	BE-5404	575
BE-2401	140	BE-3051	152, 541	BE-4105	534	BE-5405	575
BE-2500	140	BE-3055	540	BE-4106	157	BE-5406	575
BE-2501	140	BE-3056	540	BE-4107	157	BE-5410	574
BE-2600	140, 474	BE-3057	540	BE-4108	157		
BE-2601	140, 474	BE-3100	153, 535	BE-4109	157		
BE-2610	545	BE-3101	153, 534	BE-4110	158	BF-1100	162
BE-2620	8, 141	BE-3102	535	BE-4111	158	BF-1101	162
BE-2625	473	BE-3103	153, 535	BE-4112	158	BF-1200	162
BE-2630	473	BE-3104	534	BE-4113	158	BF-1201	162
BE-2640	142, 542	BE-3105	536	BE-4114	158	BF-1202	162
BE-2650	142, 542, 574	BE-3106	536	BE-4115	158	BF-1203	162
BE-2651	142	BE-3107	536	BE-4116	159	BF-1300	162
BE-2660	143, 473, 543	BE-3108	534	BE-4200	159	BF-1301	162
BE-2661	143, 473, 543	BE-3208	144, 825	BE-4201	159	BF-1400	162
BE-2670	146	BE-3209	144, 825	BE-4300	159, 857	BF-1500	163
BE-2675	146	BE-3210	144	BE-4500	159, 857	BF-1501	163
BE-2700	146	BE-3300	144	BE-4501	159, 857	BF-1502	163
BE-2701	146	BE-3301	144, 825	BE-4502	159, 857	BF-1503	163
BE-2705	146	BE-3302	144, 825	BE-4503	857	BF-1510	163
BE-2710	147	BE-3405	145	BE-4504	857	BF-1511	163
BE-2715	147	BE-3500	145	BE-4505	857	BF-1520	163
BE-2720	147	BE-3501	145	BE-4603	544	BF-1521	163, 844
BE-2725	147	BE-3502	145	BE-4700	568	BF-1530	163
BE-2730	148	BE-3503	145	BE-4701	568	BF-1531	163
BE-2735	148	BE-3520	145	BE-4702	568	BF-1540	163
BE-2740	146	BE-3530	154	BE-4704	568	BF-1541	163
BE-2745	147	BE-3535	154, 502	BE-4705	569	BF-1542	163
BE-2750	147	BE-3540	482	BE-4800	544	BF-1543	163
BE-2751	147	BE-3600	154, 532	BE-4802	569	BF-1545	162
BE-2752	147	BE-3601	154, 482, 532	BE-4803	569	BF-1546	162
BE-2753	147	BE-3610	532	BE-4805	545	BF-1550	162
BE-2754	147	BE-3611	532	BE-4808	569	BF-1551	162
BE-2755	147, 459	BE-3612	533	BE-4809	481, 544	BF-1600	170
BE-2756	147	BE-3613	533	BE-4810	491, 545	BF-1601	170
BE-2765	148	BE-3614	533	BE-4811	570	BF-1605	170
BE-2770	148	BE-3620	537	BE-4812	570	BF-1606	170
BE-2775	148	BE-3621	537	BE-4813	571	BF-1615	170
BE-2780	151, 539	BE-3622	540	BE-4814	571	BF-1620	171
BE-2800	149	BE-3625	538	BE-4815	571	BF-1621	170
BE-2805	149	BE-3630	538	BE-4820	492	BF-1623	170
BE-2810	149	BE-3650	537	BE-4825	492	BF-1630	171
BE-2815	149	BE-3651	537	BE-4900	492	BF-1631	171
BE-2820	149	BE-3652	537	BE-4901	493	BF-1632	171
BE-2830	148	BE-3653	537	BE-4902	493	BF-1645	171
BE-2831	148	BE-3654	537	BE-4903	493	BF-1716	171
BE-2832	149	BE-3655	538	BE-4904	493	BF-1719	171
BE-2833	149	BE-3656	538	BE-4905	493	BF-1815	172
BE-2845	141	BE-3660	538	BE-5001	483	BF-1818	172
BE-2900	150	BE-3665	565	BE-5002	483	BF-1820	172
BE-2901	150	BE-3700	155	BE-5003	483	BF-1823	172
BE-2902	149	BE-3701	155	BE-5004	483	BF-1826	172
BE-2903	149	BE-3702	155	BE-5005	483	BF-1915	172
BE-2904	150	BE-3705	155	BE-5006	483	BF-1917	172
BE-2905	150	BE-3710	155	BE-5010	483	BF-1920	172
BE-2906	150	BE-3715	155	BE-5015	493	BF-1921	172
BE-2907	143	BE-3720	155	BE-5020	493	BF-1930	172
BE-2908	143	BE-3813	155	BE-5025	482, 602	BF-1935	172
BE-2910	150	BE-3815	155	BE-5030	482	BF-1940	172
BE-2911	8, 141, 473, 543	BE-3819	155	BE-5101	572	BF-1945	173

Kat. No. Cat. No.	Sayfa Page	Kat. No. Cat. No.	Sayfa Page	Kat. No. Cat. No.	Sayfa Page	Kat. No. Cat. No.	Sayfa Page
BF-1950	173	BF-4521	169	BF-5426	180	BF-6703	195
BF-1955	173	BF-4523	169	BF-5430	180	BF-6704	195
BF-1960	175	BF-4600	164	BF-5455	179	BF-6705	195
BF-1965	175	BF-4618	167	BF-5460	180	BF-6706	195
BF-2014	174	BF-4621	167	BF-5465	180	BF-6707	195
BF-2018	174	BF-4623	167	BF-5470	184	BF-6708	196
BF-2115	174	BF-4718	167	BF-5475	184	BF-6709	195
BF-2116	174	BF-4721	167	BF-5480	186	BF-6710	197
BF-2214	175	BF-4723	167	BF-5520	183	BF-6711	197
BF-2217	175	BF-4818	167	BF-5524	183	BF-6712	197
BF-2220	175	BF-4821	167	BF-5530	183	BF-6713	197
BF-2314	175	BF-4823	167	BF-5540	183	BF-6714	197
BF-2320	175	BF-4918	167	BF-5560	183	BF-6715	197
BF-2500	164	BF-4921	167	BF-5565	184	BF-6716	196
BF-2501	164	BF-4923	167	BF-5570	183	BF-6717	196
BF-2502	164	BF-5014	165	BF-5571	183	BF-6802	198
BF-2503	164	BF-5016	166	BF-5575	183	BF-6803	199
BF-2600	165	BF-5018	166	BF-5613	186	BF-6804	198
BF-2601	165	BF-5022	166	BF-5615	186	BF-6805	198
BF-2700	164	BF-5025	166	BF-5617	186	BF-6806	199
BF-2701	164	BF-5050	166	BF-5621	186	BF-6807	199
BF-2812	168	BF-5055	176	BF-5623	186	BF-6808	810
BF-2816	168	BF-5060	176	BF-5713	186	BF-6809	810
BF-2818	168	BF-5065	176	BF-5717	186	BF-6811	198, 810
BF-2821	168	BF-5070	177	BF-5719	186	BF-6812	199
BF-2823	168	BF-5115	187	BF-5726	186	BF-6901	200
BF-2914	168	BF-5118	187	BF-5750	188	BF-6902	200
BF-2916	168	BF-5123	187	BF-5751	188	BF-7001	200, 810
BF-2918	168	BF-5125	177	BF-5755	189	BF-7002	200
BF-2921	168	BF-5130	177	BF-5760	187	BF-7100	201
BF-2923	168	BF-5135	177	BF-5765	187	BF-7101	201
BF-3012	168	BF-5140	177	BF-5770	189	BF-7102	201
BF-3016	168	BF-5145	177	BF-5775	188	BF-7103	201
BF-3018	168	BF-5214	178	BF-5814	190	BF-7104	202
BF-3021	168	BF-5218	178	BF-5817	190	BF-7105	202
BF-3023	168	BF-5220	178	BF-5820	190	BF-7106	202
BF-3114	168	BF-5227	178	BF-5918	189	BF-7107	202
BF-3116	168	BF-5230	178	BF-5920	189	BF-7108	203
BF-3118	168	BF-5250	182, 802	BF-6020	189	BF-7109	203
BF-3121	168	BF-5255	182, 802	BF-6114	190	BF-7110	203
BF-3123	168	BF-5260	182, 802	BF-6117	190	BF-7111	203
BF-3218	168	BF-5265	182, 802	BF-6120	190	BF-7112	203
BF-3221	168	BF-5270	178	BF-6220	190	BF-7113	801
BF-3223	168	BF-5275	178	BF-6224	190	BF-7114	801
BF-3321	168	BF-5280	182, 802	BF-6300	190	BF-7202	801
BF-3323	168	BF-5285	181	BF-6302	191	BF-7203	801
BF-3421	165	BF-5290	181	BF-6303	190	BF-7204	801
BF-3521	165	BF-5291	181	BF-6304	191	BF-7205	801
BF-3619	168	BF-5295	181	BF-6305	191	BF-7206	801
BF-3623	168	BF-5300	178	BF-6306	191	BF-7207	801
BF-3625	168	BF-5301	178	BF-6307	192, 499	BF-7208	801
BF-3719	168	BF-5302	178	BF-6308	192, 499	BF-7209	801
BF-3723	168	BF-5303	178	BF-6309	192, 499	BF-7210	801
BF-3725	168	BF-5304	178	BF-6310	192, 499	BF-7212	801
BF-4150	166	BF-5305	178	BF-6320	192, 496	BF-7215	801
BF-4155	166	BF-5306	178	BF-6401	193	BF-7300	800
BF-4200	169	BF-5307	178	BF-6402	193	BF-7301	800
BF-4214	169	BF-5308	178	BF-6403	193	BF-7302	800
BF-4218	169	BF-5309	179	BF-6404	193	BF-7400	800
BF-4221	169	BF-5310	179	BF-6501	193	BF-7401	800
BF-4223	169	BF-5311	179	BF-6502	193	BF-7402	800
BF-4300	169	BF-5312	179	BF-6503	193	BF-7405	810
BF-4314	169	BF-5313	179	BF-6504	193	BF-7417	204
BF-4318	169	BF-5314	179	BF-6600	194	BF-7420	204
BF-4321	169	BF-5315	185	BF-6601	194	BF-7421	204
BF-4323	169	BF-5316	185, 459	BF-6602	194	BF-7422	204
BF-4418	169	BF-5415	180	BF-6603	194	BF-7425	204
BF-4421	169	BF-5418	180	BF-6604	194	BF-7430	204
BF-4423	169	BF-5420	180	BF-6605	194	BF-7508	317
BF-4518	169	BF-5423	180	BF-6702	195	BF-7510	317



Kat. No. Cat. No.	Sayfa Page	Kat. No. Cat. No.	Sayfa Page	Kat. No. Cat. No.	Sayfa Page	Kat. No. Cat. No.	Sayfa Page
BF-7512	317	BG-1702	579, 752	BG-2350	222	BG-2431	452
BF-7514	317	BG-1703	578, 752	BG-2351	223	BG-2432	450
BF-7516	317	BG-1704	579, 752	BG-2352	222	BG-2433	11, 226
BF-7518	317	BG-1800	578, 752	BG-2353	222	BG-2434	226
BF-7608	317	BG-1801	578, 752	BG-2354	223	BG-2500	226
BF-7610	317	BG-1802	579, 752	BG-2355	223	BG-2501	226
BF-7612	317	BG-1803	578, 752	BG-2356	222	BG-2502	226
BF-7614	317	BG-1804	579, 752	BG-2357	222	BG-2503	226
BF-7616	317	BG-1900	578, 752	BG-2358	222	BG-2504	226
BF-7618	317	BG-1901	579, 752	BG-2359	222	BG-2505	11
BF-7708	317	BG-1902	578, 752	BG-2360	222	BG-2506	227
BF-7710	317	BG-1904	579, 752	BG-2361	222	BG-2507	227
BF-7712	317	BG-1905	578, 752	BG-2362	223	BG-2508	227
BF-7714	317	BG-1906	579, 752	BG-2363	223	BG-2509	227
BF-7716	317	BG-2000	578, 752	BG-2364	223	BG-2510	227
BF-7718	317	BG-2001	579, 752	BG-2365	223	BG-2511	227
BF-7808	317	BG-2002	578, 752	BG-2366	223	BG-2512	227
BF-7810	317	BG-2003	579, 752	BG-2367	223	BG-2613	227
BF-7812	317	BG-2004	578, 752	BG-2368	223	BG-2615	227
BF-7814	317	BG-2005	579, 752	BG-2369	475	BG-2617	227
BF-7816	317	BG-2300	218	BG-2370	475	BG-2620	227
BF-7818	317	BG-2301	218	BG-2371	224	BG-2713	227
BF-7900	205	BG-2302	219	BG-2372	224	BG-2715	227
BF-7901	205	BG-2303	219	BG-2373	224	BG-2717	227
BF-7902	205	BG-2304	218	BG-2374	224	BG-2720	227
BF-7903	205	BG-2305	218	BG-2375	233	BG-2723	227
BF-7904	205	BG-2306	218	BG-2376	224	BG-2816	228
BF-7905	205	BG-2307	218	BG-2377	224	BG-2818	228
BF-7906	205	BG-2308	218	BG-2378	224	BG-2820	228
BF-8010	205	BG-2309	218	BG-2379	224	BG-2822	228
BF-8011	205	BG-2310	218	BG-2380	224	BG-2824	228
BF-8012	205	BG-2311	218	BG-2381	224	BG-2835	228
BF-8013	205	BG-2312	218	BG-2382	233	BG-2916	228
BF-8014	205	BG-2313	218	BG-2383	224	BG-2918	228
		BG-2314	218	BG-2384	224	BG-2920	228
		BG-2315	219	BG-2385	225	BG-2922	228
BG-1101	215	BG-2316	219	BG-2386	225	BG-2924	228
BG-1106	215	BG-2317	219	BG-2387	225	BG-2935	228
BG-1107	215	BG-2318	219	BG-2388	225	BG-3024	229
BG-1200	212	BG-2319	219	BG-2400	438	BG-3026	229
BG-1201	212	BG-2320	219	BG-2401	438	BG-3028	229
BG-1202	212	BG-2321	219	BG-2402	438	BG-3124	229
BG-1203	212	BG-2322	219	BG-2403	438	BG-3126	229
BG-1204	212	BG-2323	219	BG-2404	438	BG-3128	229
BG-1205	212	BG-2324	219	BG-2405	438	BG-3200	230
BG-1206	212	BG-2325	219	BG-2406	438	BG-3201	230
BG-1207	212	BG-2326	220	BG-2407	439	BG-3202	230
BG-1208	212	BG-2327	220	BG-2408	439	BG-3203	230
BG-1209	212	BG-2328	220	BG-2409	450	BG-3204	230
BG-1210	212	BG-2329	220	BG-2410	440	BG-3205	230
BG-1301	214	BG-2330	220	BG-2411	440	BG-3206	498
BG-1302	214	BG-2331	220	BG-2412	440	BG-3207	230
BG-1303	214	BG-2332	220	BG-2413	440	BG-3208	230
BG-1304	214	BG-2333	220	BG-2414	440	BG-3209	232
BG-1305	214	BG-2334	220	BG-2415	440	BG-3210	232
BG-1306	214	BG-2335	220	BG-2416	441	BG-3316	231
BG-1312	214	BG-2336	220	BG-2417	441	BG-3318	231
BG-1317	214	BG-2337	221	BG-2418	442	BG-3320	231
BG-1325	214	BG-2338	221	BG-2419	442	BG-3322	231
BG-1330	214	BG-2339	221	BG-2420	442	BG-3324	231
BG-1333	214	BG-2340	221	BG-2421	442	BG-3326	231
BG-1342	214	BG-2341	221	BG-2422	442	BG-3328	231
BG-1352	214	BG-2342	221	BG-2423	442	BG-3335	231
BG-1355	214	BG-2343	221	BG-2424	444	BG-3416	231
BG-1360	214	BG-2344	221	BG-2425	444	BG-3418	231
BG-1365	214	BG-2345	221	BG-2426	445	BG-3420	231
BG-1650	605	BG-2346	221	BG-2427	445	BG-3422	231
BG-1655	605	BG-2347	221	BG-2428	446	BG-3424	231
BG-1700	578, 752	BG-2348	221	BG-2429	446	BG-3426	231
BG-1701	578, 752	BG-2349	222	BG-2430	445	BG-3428	231

Kat. No. Cat. No.	Sayfa Page	Kat. No. Cat. No.	Sayfa Page	Kat. No. Cat. No.	Sayfa Page	Kat. No. Cat. No.	Sayfa Page
BG-3435	231	BG-4231	237	BG-5335	248	BH-1203	213
BG-3516	232	BG-4232	237	BG-5340	247	BH-1204	213
BG-3520	232	BG-4233	237	BG-5419	248	BH-1205	213
BG-3616	232	BG-4234	237	BG-5420	248	BH-1206	213
BG-3620	232	BG-4235	237	BG-5424	248	BH-1207	213
BG-3705	232	BG-4236	237	BG-5435	248	BH-1325	217
BG-3706	232	BG-4237	238	BG-5500	248	BH-1335	217
BG-3707	232, 475	BG-4238	238	BG-5501	248	BH-1350	217
BG-3708	232, 475	BG-4239	238	BG-5502	249	BH-1368	217
BG-3819	233, 486	BG-4240	238	BG-5503	249	BH-1423	217
BG-3822	233, 486	BG-4241	238	BG-5504	251	BH-1431	217
BG-3823	233, 486	BG-4413	238	BG-5510	251	BH-1442	217
BG-3900	234	BG-4418	238	BG-5511	251	BH-1458	217
BG-3901	234	BG-4420	238	BG-5600	249	BH-1600	215
BG-3902	234	BG-4423	238	BG-5601	249	BH-1601	215
BG-3903	234	BG-4428	238	BG-5602	249	BH-1602	215
BG-4001	451	BG-4504	240	BG-5603	249	BH-1603	215
BG-4002	234	BG-4505	240	BG-5604	249	BH-1610	217
BG-4003	234	BG-4615	239	BG-5605	250	BH-1615	217
BG-4004	234	BG-4618	239	BG-5606	250	BH-1733	217
BG-4005	234	BG-4620	239	BG-5700	251	BH-1750	217
BG-4006	486	BG-4623	239	BG-5701	251	BH-1769	217
BG-4007	487	BG-4625	239	BG-5702	251	BH-1827	217
BG-4008	487	BG-4701	243, 475	BG-5800	250	BH-1833	217
BG-4009	487	BG-4702	240	BG-5801	250	BH-1850	217
BG-4010	487	BG-4820	241	BG-6300	252	BH-1869	217
BG-4011	488	BG-4824	241	BG-6301	252	BH-1938	217
BG-4012	488	BG-4827	241	BG-6302	252	BH-1954	217
BG-4013	488	BG-4900	241, 498	BG-6303	252	BH-1963	217
BG-4014	448	BG-4901	241	BG-6400	252	BH-2078	256, 284, 451
BG-4015	448	BG-4910	241	BG-6401	252	BH-2088	256, 284, 451
BG-4016	449	BG-4911	241	BG-6402	252	BH-2098	256, 451
BG-4017	489	BG-4912	241	BG-6403	252	BH-2160	284, 452
BG-4018	453	BG-4913	241	BG-6500	253	BH-2180	284, 452
BG-4019	470	BG-4914	241	BG-6501	253	BH-2200	439
BG-4118	447	BG-4915	244, 475	BG-6502	253	BH-2201	439
BG-4120	447	BG-4916	244, 475	BG-6503	253	BH-2202	439
BG-4127	447	BG-4927	243	BG-6600	254, 489	BH-2203	439
BG-4131	447	BG-5010	242	BG-6601	254	BH-2204	439
BG-4200	450	BG-5011	242	BG-6615	256, 490	BH-2205	439
BG-4201	450	BG-5012	242	BG-6620	490	BH-2206	443
BG-4202	450	BG-5013	242	BG-6700	255, 549	BH-2207	443
BG-4203	450	BG-5014	242	BG-6701	255, 549	BH-2208	443
BG-4204	450	BG-5015	245	BG-6702	255, 549	BH-2209	443
BG-4205	218	BG-5020	245, 476	BG-6703	255	BH-2210	443
BG-4206	235	BG-5022	245, 476	BG-6815	10	BH-2211	443
BG-4207	235	BG-5023	245	BG-6818	10	BH-2212	441
BG-4208	235	BG-5122	245	BG-6819	10	BH-2213	441
BG-4209	235	BG-5125	245	BG-6820	10	BH-2214	455
BG-4210	235	BG-5129	245	BG-6900	474	BH-2215	455
BG-4211	235	BG-5200	245, 547	BG-6901	474	BH-2216	456
BG-4212	235	BG-5201	245, 547	BG-7055	11	BH-2217	444
BG-4213	236	BG-5202	244, 476	BG-7100	10	BH-2218	444
BG-4214	236	BG-5203	244, 475	BG-7101	11	BH-2219	446
BG-4215	236	BG-5204	244	BG-7102	10	BH-2220	260
BG-4216	236	BG-5300	246	BG-7103	10	BH-2221	260
BG-4217	236	BG-5301	246	BG-7104	10	BH-2222	260
BG-4218	236	BG-5302	246	BG-7105	10	BH-2223	260
BG-4219	236	BG-5303	246			BH-2224	260
BG-4220	236	BG-5304	246			BH-2225	260
BG-4221	236	BG-5305	246	BH-1100	216	BH-2226	260
BG-4222	236	BG-5306	246	BH-1101	216	BH-2227	260
BG-4223	236	BG-5307	247	BH-1102	216	BH-2228	260
BG-4224	236	BG-5308	247	BH-1103	216	BH-2229	260
BG-4225	235	BG-5309	247	BH-1104	216	BH-2230	260
BG-4226	235	BG-5310	251	BH-1105	216	BH-2231	260
BG-4227	237	BG-5320	247	BH-1106	216	BH-2341	271
BG-4228	237	BG-5321	247	BH-1200	213	BH-2365	271
BG-4229	237	BG-5324	247	BH-1201	213	BH-2380	271
BG-4230	237	BG-5330	248	BH-1202	213	BH-2441	271



Kat. No. Cat. No.	Sayfa Page	Kat. No. Cat. No.	Sayfa Page	Kat. No. Cat. No.	Sayfa Page	Kat. No. Cat. No.	Sayfa Page
BJ-2725	504	BH-4440	263	BH-5547	289	BJ-1611	301
BJ-2726	504	BH-4441	263	BH-5548	289	BJ-1612	301
BJ-2727	504	BH-4442	263	BH-5550	291	BJ-1623	301, 827
BJ-2728	504	BH-4443	263	BH-5560	291	BJ-1630	301, 827
BJ-2729	504	BH-4460	264	BH-5631	293	BJ-1635	301, 827
BJ-2730	504	BH-4461	264	BH-5644	293	BJ-1640	301, 827
BJ-2803	48	BH-4490	264	BH-5650	293	BJ-1645	304
BJ-2804	48	BH-4491	264	BH-5663	293	BJ-1719	301, 472
BJ-2805	48	BH-4492	264	BH-5678	293	BJ-1725	301
BJ-2806	48	BH-4495	265	BH-5701	294	BJ-1730	834
BJ-2807	48	BH-4496	265	BH-5702	294	BJ-1740	301
BJ-2808	48	BH-4497	265	BH-5703	294	BJ-1800	301
BJ-2809	48	BH-4500	265	BH-5704	294	BJ-1801	301
BJ-2810	48	BH-4520	265	BH-5705	294	BJ-1802	302
BJ-2850	567	BH-4530	267	BH-5706	294	BJ-1803	302
BJ-2903	502	BH-4531	267	BH-5780	276	BJ-1804	302
BJ-2904	502	BH-4601	267	BH-5790	276	BJ-1805	302
BJ-2905	502	BH-4602	267	BH-5940	296	BJ-1806	302
BJ-2906	502	BH-4603	267	BH-5941	296	BJ-1807	302
BJ-3024	505	BH-4604	267	BH-5942	297	BJ-1808	302
BJ-3025	505	BH-4701	268	BH-5950	295	BJ-1900	302
BJ-3026	505	BH-4702	268	BH-5951	295	BJ-1901	302
BJ-3027	505	BH-4703	268	BH-5952	295	BJ-1902	302
BJ-3028	505	BH-4704	268	BH-5953	295	BJ-1903	302
BJ-3029	505	BH-4705	268	BH-5954	295	BJ-1904	302
BJ-3030	505	BH-4710	268	BH-6001	285	BJ-1910	302
BJ-3031	505	BH-4720	268	BH-6002	285	BJ-1915	302
BJ-3032	505	BH-4725	268	BH-6003	285	BJ-2001	564
BJ-3033	505	BH-4730	281	BH-6004	285	BJ-2004	316
BJ-3034	505	BH-4750	281	BH-6005	285	BJ-2010	303
BJ-3035	505	BH-4760	278	BH-6006	285	BJ-2012	303
BJ-3036	505	BH-4765	278	BH-6007	285	BJ-2015	303
BJ-3037	505	BH-4901	272	BH-6008	285	BJ-2018	303
BJ-3038	505	BH-4902	272	BH-6009	285	BJ-2100	304
BJ-3039	505	BH-4903	272	BH-6010	285	BJ-2101	304
BJ-3040	505	BH-4904	272			BJ-2211	304
BJ-3041	505	BH-5001	272			BJ-2214	303
BJ-3042	505	BH-5002	272	BJ-1106	300	BJ-2216	303
BJ-3043	505	BH-5003	272	BJ-1107	300	BJ-2311	304
BJ-3044	505	BH-5004	272	BJ-1108	300	BJ-2314	303
BJ-3045	505	BH-5020	286	BJ-1109	300	BJ-2316	303
BJ-3046	505	BH-5021	286	BJ-1110	300	BJ-2317	303
BJ-3047	505	BH-5022	286	BJ-1111	300	BJ-2420	304
BJ-3048	505	BH-5200	286	BJ-1112	300, 472	BJ-2430	478
BJ-3049	505	BH-5201	286	BJ-1200	300, 472	BJ-2435	478
BJ-3050	505	BH-5202	286	BJ-1245	300, 472	BJ-2505	754
BJ-3051	505	BH-5203	286	BJ-1290	300, 472	BJ-2510	754
BJ-3052	505	BH-5204	287	BJ-1295	300, 472	BJ-2515	754
BJ-3053	505	BH-5205	287	BJ-1300	300, 472	BJ-2540	755
BJ-3054	505	BH-5207	287	BJ-1413	301	BJ-2550	755
BJ-3055	505	BH-5208	287	BJ-1414	301	BJ-2638	478
BJ-3056	505	BH-5209	287	BJ-1416	301	BJ-2643	478
BJ-3057	505	BH-5211	287	BJ-1418	301	BJ-2668	478
BJ-3058	505	BH-5500	288	BJ-1420	301	BJ-2708	504
BJ-3059	505	BH-5501	288	BJ-1450	301	BJ-2709	504
BJ-3060	505	BH-5511	288	BJ-1504	306	BJ-2710	504
BJ-3100	505	BH-5512	288	BJ-1505	306, 308	BJ-2711	504
BJ-3201	505	BH-5520	289	BJ-1507	306, 308	BJ-2712	504
BJ-3202	505	BH-5521	289	BJ-1510	306, 308	BJ-2713	504
BJ-3203	505	BH-5522	289	BJ-1512	306	BJ-2714	504
BJ-3204	505	BH-5530	290	BJ-1600	301	BJ-2715	504
BJ-3205	505	BH-5531	290	BJ-1601	301	BJ-2716	504
BJ-3206	505	BH-5532	290	BJ-1602	301	BJ-2717	504
BJ-3207	505	BH-5533	290	BJ-1603	301	BJ-2718	504
BJ-3215	306	BH-5541	292	BJ-1604	301	BJ-2719	504
BJ-3220	306	BH-5542	292	BJ-1605	301	BJ-2720	504
BJ-3225	306	BH-5543	292	BJ-1606	301	BJ-2721	504
BJ-3230	306	BH-5544	292	BJ-1607	301	BJ-2722	504
BJ-3306	505	BH-5545	292	BJ-1608	301	BJ-2723	504
BJ-3307	505	BH-5546	289	BJ-1609	301	BJ-2724	504

Kat. No. Cat. No.	Sayfa Page	Kat. No. Cat. No.	Sayfa Page	Kat. No. Cat. No.	Sayfa Page	Kat. No. Cat. No.	Sayfa Page
BJ-2725	504	BJ-3308	503	BJ-4530	307	BJ-8013	310
BJ-2726	504	BJ-3309	503	BJ-4633	307	BJ-8102	314
BJ-2727	504	BJ-3310	503	BJ-4730	307	BJ-8103	314, 607
BJ-2728	504	BJ-3311	503	BJ-4810	309	BJ-8106	314, 607
BJ-2729	504	BJ-3312	503	BJ-4814	309	BJ-8107	314, 607
BJ-2730	504	BJ-3313	503	BJ-4817	309	BJ-8120	314, 607
BJ-2803	481	BJ-3314	503	BJ-4820	309	BJ-8185	311
BJ-2804	481	BJ-3315	503	BJ-4823	309	BJ-8190	308
BJ-2805	481	BJ-3316	503	BJ-4827	309	BJ-8191	308
BJ-2806	481	BJ-3318	503	BJ-4830	309	BJ-8192	308
BJ-2807	481	BJ-3320	503	BJ-4840	309	BJ-8200	478
BJ-2808	481	BJ-3349	504	BJ-4910	309	BJ-8204	310
BJ-2809	481	BJ-3353	309	BJ-4914	309	BJ-8205	310
BJ-2810	481	BJ-3354	309	BJ-4917	309	BJ-8206	310
BJ-2850	567	BJ-3355	309	BJ-4920	309	BJ-8207	311
BJ-2903	502	BJ-3356	309	BJ-4923	309	BJ-8208	311
BJ-2904	502	BJ-3400	504	BJ-4927	309	BJ-8209	311
BJ-2905	502	BJ-3413	309	BJ-4930	309	BJ-8305	308
BJ-2906	502	BJ-3415	309	BJ-4940	309	BJ-8310	308
BJ-3024	505	BJ-3416	309	BJ-5010	309	BJ-8413	308
BJ-3025	505	BJ-3418	309	BJ-5014	309	BJ-8420	308
BJ-3026	505	BJ-3500	504	BJ-5017	309	BJ-8421	308
BJ-3027	505	BJ-3513	309	BJ-5020	309	BJ-8422	308
BJ-3028	505	BJ-3515	309	BJ-5023	309	BJ-8423	308
BJ-3029	505	BJ-3516	309	BJ-5027	309	BJ-8426	313
BJ-3030	505	BJ-3518	309	BJ-5030	309	BJ-8427	313
BJ-3031	505	BJ-3600	316	BJ-5040	309	BJ-8428	313
BJ-3032	505	BJ-3601	316	BJ-5110	309	BJ-8429	313
BJ-3033	505	BJ-3602	316	BJ-5114	309	BJ-8433	312
BJ-3034	505	BJ-3610	301	BJ-5117	309	BJ-8434	312
BJ-3035	505	BJ-3715	305	BJ-5120	309	BJ-8435	312
BJ-3036	505	BJ-3720	305	BJ-5123	309	BJ-8436	312
BJ-3037	505	BJ-3725	305	BJ-5127	309	BJ-8437	313
BJ-3038	505	BJ-3730	305	BJ-5130	309	BJ-8438	313
BJ-3039	505	BJ-3740	305	BJ-5140	309	BJ-8439	313
BJ-3040	505	BJ-3750	305	BJ-5227	309	BJ-8454	315, 561
BJ-3041	505	BJ-3815	305	BJ-5327	309	BJ-8456	315, 561
BJ-3042	505	BJ-3820	305	BJ-5430	306	BJ-8458	315, 561
BJ-3043	505	BJ-3825	305	BJ-6001	307	BJ-8460	315, 561
BJ-3044	505	BJ-3830	305	BJ-6005	307	BJ-8462	315, 561
BJ-3045	505	BJ-3840	305	BJ-6007	307	BJ-8464	315, 561
BJ-3046	505	BJ-3850	305	BJ-6010	307	BJ-8465	315, 561
BJ-3047	505	BJ-3900	316	BJ-6013	307	BJ-8470	315, 561
BJ-3048	505	BJ-3901	316	BJ-6050	307	BJ-8475	306
BJ-3049	505	BJ-3902	316	BJ-6100	307	BJ-8590	561
BJ-3050	505	BJ-3903	316	BJ-6104	307	BJ-8591	561
BJ-3051	505	BJ-3910	316	BJ-6106	307	BJ-8592	561
BJ-3052	505	BJ-3911	316	BJ-6108	307	BJ-8595	561
BJ-3053	505	BJ-3915	305	BJ-6150	307	BJ-8600	562
BJ-3054	505	BJ-3917	564	BJ-7013	312	BJ-8601	562
BJ-3055	505	BJ-3920	305	BJ-7015	312	BJ-8602	562
BJ-3056	505	BJ-3925	305	BJ-7018	312	BJ-8603	562
BJ-3057	505	BJ-3930	305	BJ-7022	312	BJ-8604	562
BJ-3058	505	BJ-3940	305	BJ-7113	312	BJ-8605	562
BJ-3059	505	BJ-3950	305	BJ-7115	312	BJ-8606	563
BJ-3060	505	BJ-4015	305	BJ-7118	312	BJ-8607	563
BJ-3100	505	BJ-4020	305	BJ-7122	312	BJ-8608	562
BJ-3201	503	BJ-4025	305	BJ-7213	312	BJ-8609	562
BJ-3202	503	BJ-4030	305	BJ-7215	312	BJ-8610	562
BJ-3203	503	BJ-4040	305	BJ-7218	312	BJ-8611	563
BJ-3204	503	BJ-4050	305	BJ-7222	312	BJ-8614	599
BJ-3205	503	BJ-4140	306	BJ-7313	312	BJ-8615	599
BJ-3206	503	BJ-4240	305	BJ-7315	312	BJ-8616	599
BJ-3207	503	BJ-4323	305	BJ-7318	312	BJ-8617	599
BJ-3215	306	BJ-4327	305	BJ-7322	312	BJ-8618	599
BJ-3220	306	BJ-4334	305	BJ-7418	312	BJ-8619	599
BJ-3225	306	BJ-4340	305	BJ-8001	312	BJ-8620	599
BJ-3230	306	BJ-4430	305	BJ-8002	312	BJ-8621	599
BJ-3306	503	BJ-4450	305	BJ-8011	310	BJ-8622	599
BJ-3307	503	BJ-4520	307	BJ-8012	310	BJ-8623	599



Kat. No. Cat. No.	Sayfa Page	Kat. No. Cat. No.	Sayfa Page	Kat. No. Cat. No.	Sayfa Page	Kat. No. Cat. No.	Sayfa Page
BJ-8624	599	BJ-8789	601	BJ-9004	526	BK-1301	320
BJ-8625	599	BJ-8790	601	BJ-9005	526	BK-1302	320
BJ-8626	599	BJ-8791	601	BJ-9006	526	BK-1304	320
BJ-8633	599	BJ-8800	601	BJ-9007	526	BK-1307	320
BJ-8634	599	BJ-8801	601	BJ-9008	526	BK-1310	321, 756
BJ-8635	599	BJ-8802	601	BJ-9009	526	BK-1311	321, 756
BJ-8700	600	BJ-8803	601	BJ-9010	526	BK-1312	321, 756
BJ-8701	600	BJ-8804	601	BJ-9011	526	BK-1313	321, 756
BJ-8702	600	BJ-8805	601	BJ-9012	526	BK-1320	756
BJ-8703	600	BJ-8806	601	BJ-9013	526	BK-1321	756
BJ-8704	600	BJ-8807	601	BJ-9014	526	BK-1322	756
BJ-8705	600	BJ-8808	601	BJ-9015	526	BK-1323	756
BJ-8706	600	BJ-8809	601	BJ-9016	526	BK-1330	321, 757
BJ-8707	600	BJ-8810	601	BJ-9017	526	BK-1331	321, 757
BJ-8708	600	BJ-8811	601	BJ-9018	526	BK-1332	321, 757
BJ-8709	600	BJ-8820	601	BJ-9019	526	BK-1333	321, 757
BJ-8710	600	BJ-8821	601	BJ-9020	526	BK-1340	762
BJ-8711	600	BJ-8822	601	BJ-9021	526	BK-1341	762
BJ-8712	600	BJ-8823	601	BJ-9022	526	BK-1342	783
BJ-8713	600	BJ-8824	601	BJ-9023	526	BK-1343	781
BJ-8714	600	BJ-8825	601	BJ-9024	526	BK-1344	322
BJ-8720	600	BJ-8826	601	BJ-9025	526	BK-1347	322
BJ-8721	600	BJ-8827	601	BJ-9026	526	BK-1348	322
BJ-8722	600	BJ-8828	601	BJ-9101	526	BK-1349	322
BJ-8723	600	BJ-8829	601	BJ-9102	526	BK-1350	322
BJ-8724	600	BJ-8830	601	BJ-9103	526	BK-1351	322
BJ-8725	600	BJ-8831	601	BJ-9104	526	BK-1360	322
BJ-8726	600	BJ-8860	603	BJ-9105	526	BK-1361	322
BJ-8727	600	BJ-8861	603	BJ-9106	526	BK-1362	322
BJ-8728	600	BJ-8862	603	BJ-9107	526	BK-1363	322, 840
BJ-8729	600	BJ-8863	603	BJ-9108	526	BK-1364	322
BJ-8730	600	BJ-8870	603	BJ-9109	526	BK-1365	322
BJ-8731	600	BJ-8871	603	BJ-9110	526	BK-1366	322
BJ-8732	600	BJ-8872	603	BJ-9111	526	BK-1367	322
BJ-8733	600	BJ-8873	603	BJ-9112	526	BK-1368	323
BJ-8734	600	BJ-8874	603	BJ-9113	526	BK-1370	323
BJ-8740	480	BJ-8875	603	BJ-9114	526	BK-1371	323
BJ-8741	480	BJ-8876	603	BJ-9115	526	BK-1372	323
BJ-8742	480	BJ-8877	603	BJ-9116	526	BK-1373	323
BJ-8743	480	BJ-8878	603	BJ-9117	526	BK-1375	323, 757
BJ-8744	480	BJ-8880	603	BJ-9201	526	BK-1377	324, 757
BJ-8745	480	BJ-8884	602	BJ-9202	526	BK-1380	323
BJ-8746	480	BJ-8885	602	BJ-9203	526	BK-1383	323
BJ-8747	480	BJ-8886	602	BJ-9204	526	BK-1386	323
BJ-8748	480	BJ-8887	602	BJ-9205	526	BK-1388	323
BJ-8749	480	BJ-8890	315, 607	BJ-9206	526	BK-1390	323
BJ-8750	480	BJ-8891	311	BJ-9207	526	BK-1391	320
BJ-8751	480	BJ-8892	310	BJ-9208	526	BK-1392	320
BJ-8752	480	BJ-8900	310	BJ-9209	526	BK-1393	324, 757
BJ-8760	601	BJ-8901	310	BJ-9301	526	BK-1396	324
BJ-8761	601	BJ-8902	310	BJ-9302	526	BK-1397	324
BJ-8762	601	BJ-8903	315, 863	BJ-9303	526	BK-1398	324
BJ-8763	601	BJ-8906	478, 530	BJ-9304	526	BK-1399	324
BJ-8764	601	BJ-8907	530	BJ-9305	526	BK-1400	324
BJ-8765	601	BJ-8908	530	BJ-9306	526	BK-1404	320
BJ-8766	601	BJ-8909	530	BJ-9307	526	BK-1410	323
BJ-8767	601	BJ-8910	531	BJ-9308	526	BK-1411	323
BJ-8768	601	BJ-8911	530	BJ-9500	527	BK-1412	323
BJ-8769	601	BJ-8912	531	BJ-9600	527	BK-1420	325
BJ-8770	601	BJ-8913	316	BJ-9700	527	BK-1421	325
BJ-8771	601	BJ-8914	606			BK-1426	325
BJ-8780	601	BJ-8915	606			BK-1430	325
BJ-8781	601	BJ-8940	306	BK-1270	320	BK-1431	325
BJ-8782	601	BJ-8941	306	BK-1271	320	BK-1432	325
BJ-8783	601	BJ-8942	306	BK-1272	320	BK-1433	325
BJ-8784	601	BJ-8943	306	BK-1273	320	BK-1434	325
BJ-8785	601	BJ-8944	306	BK-1290	320	BK-1435	325
BJ-8786	601	BJ-9001	526	BK-1291	320	BK-1436	325
BJ-8787	601	BJ-9002	526	BK-1292	320	BK-1437	325
BJ-8788	601	BJ-9003	526	BK-1300	320	BK-1438	325

Kat. No. Cat. No.	Sayfa Page	Kat. No. Cat. No.	Sayfa Page	Kat. No. Cat. No.	Sayfa Page	Kat. No. Cat. No.	Sayfa Page
BK-1439	326	BK-1552	332	BK-2990	338	BK-5046	344
BK-1440	326	BK-1556	333	BK-2995	338	BK-5047	344
BK-1441	326	BK-1557	333	BK-2996	338	BK-5048	344
BK-1442	326	BK-1558	333	BK-2997	338	BK-5050	345
BK-1443	326	BK-1559	333	BK-3001	339	BK-5052	345
BK-1444	326	BK-1563	331	BK-3005	339	BK-5053	345
BK-1445	326	BK-1564	330	BK-3010	339	BK-5054	345
BK-1446	326	BK-1565	330	BK-3020	339	BK-5055	345
BK-1447	326	BK-1570	330	BK-3021	339	BK-5056	345
BK-1448	326	BK-1571	330	BK-3022	339	BK-5057	345
BK-1449	326	BK-1572	330	BK-3035	339	BK-5058	345
BK-1450	326	BK-1573	330	BK-3070	531	BK-5059	345
BK-1451	326, 500	BK-1574	330	BK-3080	340	BK-5060	346
BK-1452	326	BK-1580	331	BK-3082	340	BK-5061	346
BK-1453	326	BK-1580	331	BK-3083	340	BK-5062	346
BK-1454	326	BK-1582	331	BK-3090	340	BK-5063	346
BK-1460	327	BK-1585	331	BK-3091	340	BK-5070	346
BK-1461	327	BK-1590	331	BK-4003	340	BK-5080	347
BK-1462	327	BK-1612	333	BK-4004	340	BK-5081	347
BK-1463	327	BK-1614	333	BK-4300	341	BK-5082	347
BK-1464	327	BK-1616	333	BK-4301	341	BK-5083	347
BK-1465	327	BK-1618	333	BK-4302	341	BK-5084	347
BK-1466	327	BK-1620	331	BK-4303	341	BK-5085	347
BK-1467	327	BK-1630	331	BK-4400	341	BK-5086	347
BK-1468	327	BK-1725	331	BK-4401	341	BK-5087	347
BK-1469	327	BK-1825	331	BK-4402	341	BK-5088	347
BK-1470	327	BK-1925	331	BK-4403	341	BK-5089	347
BK-1471	327	BK-2002	333	BK-4500	341	BK-5090	347
BK-1472	327	BK-2003	333	BK-4501	341	BK-5091	347
BK-1473	327	BK-2010	334	BK-4502	341	BK-5100	348
BK-1474	327	BK-2020	334	BK-4503	341	BK-5101	348
BK-1475	327	BK-2030	334	BK-4504	341	BK-5102	348
BK-1476	328	BK-2040	334	BK-4600	341	BK-5103	348
BK-1480	328	BK-2104	334	BK-4601	341	BK-5104	348
BK-1481	328	BK-2106	334	BK-4602	341	BK-5200	348
BK-1482	328	BK-2108	334	BK-4603	341	BK-5201	348
BK-1483	328	BK-2110	334	BK-4604	341	BK-5202	348
BK-1490	328	BK-2303	334	BK-4700	341	BK-5400	349
BK-1491	328	BK-2305	334	BK-4701	341	BK-5401	349
BK-1492	328	BK-2307	334	BK-4702	341	BK-5600	349
BK-1493	328	BK-2310	334	BK-4703	341	BK-5601	349
BK-1494	328	BK-2330	334	BK-4704	341	BK-5610	350, 819
BK-1495	328	BK-2345	565	BK-4800	342	BK-5611	350, 819
BK-1496	328	BK-2350	335	BK-4801	342	BK-5612	350, 819
BK-1500	329	BK-2355	335	BK-4802	342	BK-5613	350, 819
BK-1501	329	BK-2360	335	BK-4803	342	BK-5614	350, 819
BK-1502	329	BK-2365	335	BK-4900	342	BK-5620	350, 819
BK-1503	329	BK-2412	335	BK-4901	342	BK-5625	350, 819
BK-1504	329	BK-2415	335	BK-4902	342	BK-5630	351, 819
BK-1505	329	BK-2515	335	BK-4903	342	BK-5640	352
BK-1506	329	BK-2613	336	BK-5000	342	BK-5641	352
BK-1508	329	BK-2713	336	BK-5001	342	BK-5642	352
BK-1509	329	BK-2818	336	BK-5002	342	BK-5650	352
BK-1512	330	BK-2915	336	BK-5003	343	BK-5655	352
BK-1513	330	BK-2916	336	BK-5005	343	BK-5660	351
BK-1514	330	BK-2917	336	BK-5010	343	BK-5680	353
BK-1515	330	BK-2920	337	BK-5011	343	BK-5681	353
BK-1516	472	BK-2950	337	BK-5012	343	BK-5682	353
BK-1520	332	BK-2951	337	BK-5013	343	BK-5683	353
BK-1521	332	BK-2952	337	BK-5020	344	BK-5690	353
BK-1522	332	BK-2953	337	BK-5021	344	BK-5691	353
BK-1523	332	BK-2954	338	BK-5022	344	BK-5692	353
BK-1524	332	BK-2955	338	BK-5023	344	BK-5693	353
BK-1525	332	BK-2960	338	BK-5030	351	BK-5700	354
BK-1535	332	BK-2965	338	BK-5040	344	BK-5701	354
BK-1540	332	BK-2970	337	BK-5041	344	BK-5702	354
BK-1541	332	BK-2975	337	BK-5042	344	BK-5703	354
BK-1542	332	BK-2980	648	BK-5043	344	BK-5800	753
BK-1550	332	BK-2981	648	BK-5044	344	BK-5801	753
BK-1551	332	BK-2982	648	BK-5045	344	BK-5802	753



Kat. No. Cat. No.	Sayfa Page	Kat. No. Cat. No.	Sayfa Page	Kat. No. Cat. No.	Sayfa Page	Kat. No. Cat. No.	Sayfa Page
BK-5803	753	BK-8303	358	BK-8572	520	BK-8771	387
BK-5804	753	BK-8310	359	BK-8573	520	BK-8775	387
BK-5805	774	BK-8311	359	BK-8574	520	BK-8776	387
BK-5810	774	BK-8312	359	BK-8575	520	BK-8780	388
BK-5918	788	BK-8313	359	BK-8576	520	BK-8781	388
BK-5920	788	BK-8314	359	BK-8577	520	BK-8782	388
BK-5923	788	BK-8315	359	BK-8578	520	BK-8783	388
BK-6001	788	BK-8316	359	BK-8579	520	BK-8800	524
BK-6002	788	BK-8317	460	BK-8580	520	BK-8801	524
BK-6005	788	BK-8320	360, 521	BK-8581	595	BK-8802	524
BK-6200	751	BK-8325	360, 521	BK-8590	595	BK-8810	524
BK-6201	751	BK-8330	360, 521	BK-8591	595	BK-8811	524
BK-6202	751	BK-8335	360, 521	BK-8592	595	BK-8812	524
BK-6203	751	BK-8340	361	BK-8593	595	BK-8813	524
BK-6204	751	BK-8341	361	BK-8594	595	BK-8814	524
BK-6300	750	BK-8342	361	BK-8595	594	BK-8820	524
BK-6301	750	BK-8343	361	BK-8600	592	BK-8821	524
BK-6302	750	BK-8350	362	BK-8601	594	BK-8822	524
BK-6303	750	BK-8355	362	BK-8602	592	BK-8823	524
BK-6304	750	BK-8360	362	BK-8603	594	BK-8824	524
BK-6305	750	BK-8370	363	BK-8604	592	BK-8825	524
BK-6400	750	BK-8371	363	BK-8605	594	BK-8826	524
BK-6401	750	BK-8372	363	BK-8610	594	BK-8827	524
BK-6402	750	BK-8380	364	BK-8611	594	BK-8828	524
BK-6500	750	BK-8381	364	BK-8612	593	BK-8830	388
BK-6501	750	BK-8382	364	BK-8620	594	BK-8840	388
BK-6502	750	BK-8385	364	BK-8621	594	BK-8841	488
BK-6600	750	BK-8390	365	BK-8622	593	BK-8842	388
BK-6601	750	BK-8395	366	BK-8630	378	BK-8843	388
BK-6800	750	BK-8396	366	BK-8631	378	BK-8844	388
BK-6801	750	BK-8400	365	BK-8632	378	BK-8845	388
BK-6802	750	BK-8401	367	BK-8633	378	BK-8846	389
BK-6803	750	BK-8402	367	BK-8634	379	BK-8847	389
BK-6900	750	BK-8403	367	BK-8640	379	BK-8850	390, 750
BK-6901	750	BK-8404	367	BK-8641	379	BK-8851	390
BK-6902	750	BK-8405	367	BK-8650	380, 519	BK-8852	390
BK-6903	750	BK-8406	368	BK-8651	380, 519	BK-8855	390
BK-7400	750	BK-8410	368	BK-8652	380, 519	BK-8860	391
BK-7401	750	BK-8411	368	BK-8660	380, 519	BK-8861	391
BK-7402	750	BK-8412	368	BK-8661	380, 519	BK-8862	391
BK-7403	750	BK-8413	368	BK-8662	380, 519	BK-8863	391
BK-7500	750	BK-8414	368	BK-8670	380, 519	BK-8870	390
BK-7501	750	BK-8415	368	BK-8671	380, 519	BK-8871	390
BK-7502	750	BK-8416	368	BK-8672	380, 519	BK-8872	390
BK-7503	750	BK-8500	369	BK-8675	380, 519	BK-8873	390
BK-7504	750	BK-8501	369	BK-8680	380, 519	BK-8874	390
BK-8205	2	BK-8502	369	BK-8690	522	BK-8875	391
BK-8206	2	BK-8503	370	BK-8691	522	BK-8881	391
BK-8207	2	BK-8504	370	BK-8692	522	BK-8885	497
BK-8208	2	BK-8505	371	BK-8700	381	BK-8890	391
BK-8210	2	BK-8506	371	BK-8710	382	BK-8895	497
BK-8218	355	BK-8507	372	BK-8711	382	BK-8940	512
BK-8219	355	BK-8508	372	BK-8715	381	BK-8941	512
BK-8250	355	BK-8509	369	BK-8720	383	BK-8942	512
BK-8251	355	BK-8510	369	BK-8721	383	BK-8950	512
BK-8265	355	BK-8511	373	BK-8722	383	BK-8951	512
BK-8270	356	BK-8520	373	BK-8723	383	BK-8952	512
BK-8271	356	BK-8521	374	BK-8724	383	BK-8953	512
BK-8272	356	BK-8522	374	BK-8730	495	BK-8960	512
BK-8273	356	BK-8523	375	BK-8735	430, 495	BK-8961	512
BK-8274	356	BK-8530	375	BK-8740	384, 461	BK-8962	512
BK-8280	356	BK-8535	376	BK-8741	384, 461	BK-8963	512
BK-8281	356	BK-8540	390	BK-8742	384, 461	BK-8964	512
BK-8282	356	BK-8550	376	BK-8745	377, 497	BK-8970	513
BK-8290	357	BK-8551	390	BK-8750	385, 497	BK-8971	513
BK-8291	357	BK-8555	520	BK-8751	385	BK-8972	513
BK-8292	357	BK-8560	520	BK-8755	377	BK-8973	513
BK-8300	358	BK-8565	520	BK-8760	386	BK-8980	514
BK-8301	358	BK-8570	520	BK-8765	386	BK-8981	514
BK-8302	358	BK-8571	520	BK-8770	387	BK-8982	514

Kat. No. Cat. No.	Sayfa Page	Kat. No. Cat. No.	Sayfa Page	Kat. No. Cat. No.	Sayfa Page	Kat. No. Cat. No.	Sayfa Page
BK-8983	514	BM-1119	395	BM-1759	404	BM-2048	412
BK-8984	514	BM-1120	395	BM-1760	404	BM-2049	412
BK-8990	513	BM-1245	3	BM-1761	405	BM-2050	412
BK-8991	513	BM-1250	3	BM-1762	405	BM-2100	413
BK-8992	513	BM-1255	3	BM-1764	405	BM-2101	413
BK-8993	513	BM-1260	3	BM-1800	406	BM-2110	414
BK-9010	514	BM-1265	3	BM-1801	406	BM-2111	414
BK-9011	514	BM-1290	3	BM-1802	406	BM-2120	413
BK-9012	514	BM-1515	778	BM-1803	406	BM-2121	413
BK-9013	514	BM-1550	778	BM-1804	406	BM-2122	413
BK-9014	514	BM-1551	778	BM-1805	406	BM-2123	413
BK-9025	518	BM-1600	779	BM-1806	406	BM-2124	413
BK-9030	515	BM-1601	779	BM-1807	406	BM-2125	413
BK-9031	515	BM-1602	779	BM-1808	406	BM-2126	413
BK-9032	515	BM-1605	779	BM-1809	406	BM-2127	413
BK-9035	518	BM-1610	778	BM-1810	406	BM-2128	413
BK-9040	515	BM-1611	778	BM-1811	406	BM-2129	413
BK-9041	515	BM-1612	778	BM-1820	407	BM-2130	413
BK-9042	515	BM-1613	778	BM-1821	407	BM-2131	413
BK-9050	516	BM-1700	396, 845	BM-1830	407	BM-2132	413
BK-9055	516	BM-1701	396	BM-1831	407	BM-2133	413
BK-9060	516	BM-1702	396	BM-1832	407	BM-2134	413
BK-9065	516	BM-1703	396	BM-1840	407	BM-2135	413
BK-9070	516	BM-1704	396	BM-1841	407	BM-2136	413
BK-9075	516	BM-1705	396	BM-1842	407	BM-2137	413
BK-9080	516	BM-1706	397	BM-1860	401	BM-2138	413
BK-9090	517	BM-1707	397	BM-1861	401	BM-2139	413
BK-9091	517	BM-1709	397	BM-1862	401	BM-2140	413
BK-9092	517	BM-1710	397	BM-1870	430	BM-2141	413
BK-9100	517	BM-1711	397	BM-1871	430	BM-2142	413
BK-9101	517	BM-1712	397	BM-1872	430	BM-2143	413
BK-9102	517	BM-1713	398	BM-1873	430	BM-2144	413
BK-9110	517	BM-1714	398	BM-1875	408	BM-2145	414
BK-9111	517	BM-1717	398	BM-1880	408	BM-2146	414
BK-9112	517	BM-1718	398	BM-1885	408, 525	BM-2147	790
BK-9120	518	BM-1719	398	BM-1890	408, 525	BM-2148	414
BK-9121	518	BM-1720	398	BM-1895	408, 525	BM-2149	790
BK-9130	518	BM-1721	399	BM-1897	408	BM-2150	414
BK-9131	518	BM-1722	399	BM-1898	409, 525	BM-2151	414
BK-9140	518	BM-1723	399	BM-1910	409	BM-2152	414
BK-9150	522	BM-1724	399	BM-1960	395	BM-2153	414
BK-9151	522	BM-1725	399	BM-1970	414	BM-2154	414
BK-9200	523	BM-1726	399	BM-1971	414	BM-2155	414
BK-9300	523	BM-1727	399	BM-1972	414	BM-2156	414
BK-9400	523	BM-1728	401	BM-1973	414	BM-2157	414
BK-9500	523	BM-1730	399	BM-2000	411	BM-2158	414
BK-9700	523	BM-1731	399	BM-2001	411	BM-2159	414
BK-9701	523	BM-1732	400	BM-2002	411	BM-2160	414
BK-9702	523	BM-1733	400	BM-2003	411	BM-2161	414
		BM-1734	400	BM-2004	411	BM-2162	414
		BM-1737	400	BM-2005	411	BM-2163	414
BM-1100	845	BM-1738	400	BM-2006	411	BM-2164	414
BM-1101	394	BM-1739	400	BM-2007	411	BM-2165	414
BM-1102	394	BM-1740	401	BM-2008	411	BM-2166	414
BM-1103	394	BM-1741	401	BM-2009	411	BM-2167	414
BM-1104	394	BM-1742	401	BM-2010	411	BM-2168	414
BM-1105	394	BM-1743	402	BM-2011	411	BM-2169	414
BM-1106	394	BM-1744	402	BM-2020	411	BM-2170	414
BM-1107	394	BM-1745	402	BM-2021	411	BM-2171	414
BM-1108	394	BM-1746	402	BM-2022	411	BM-2172	414
BM-1109	394	BM-1747	402	BM-2023	411	BM-2173	414
BM-1110	394	BM-1748	402	BM-2024	411	BM-2180	416
BM-1111	395, 845	BM-1749	402	BM-2025	411	BM-2181	416
BM-1112	395	BM-1750	402	BM-2026	411	BM-2182	417
BM-1113	395	BM-1751	402	BM-2030	412	BM-2190	416
BM-1114	395	BM-1753	403	BM-2031	411	BM-2191	416
BM-1115	395	BM-1754	403	BM-2032	412	BM-2192	417
BM-1116	395	BM-1755	403	BM-2033	412	BM-2200	416
BM-1117	395	BM-1757	404	BM-2039	412	BM-2201	416
BM-1118	395	BM-1758	404	BM-2047	412	BM-2202	417



Kat. No. Cat. No.	Sayfa Page	Kat. No. Cat. No.	Sayfa Page	Kat. No. Cat. No.	Sayfa Page	Kat. No. Cat. No.	Sayfa Page
BM-2210	416	BM-2289	417, 791	BM-2390	417, 791	BM-2610	421
BM-2211	416	BM-2290	417, 791	BM-2400	410	BM-2611	421
BM-2212	416	BM-2291	417, 791	BM-2401	410	BM-2612	421
BM-2213	416	BM-2292	417, 791	BM-2402	410	BM-2620	421
BM-2214	416	BM-2293	417, 791	BM-2403	410	BM-2621	421
BM-2215	416	BM-2294	417, 791	BM-2404	410	BM-2650	430, 494
BM-2216	416	BM-2300	417, 791	BM-2405	410	BM-2651	494
BM-2217	416	BM-2301	417, 791	BM-2410	410, 648	BM-2652	430, 494
BM-2218	416	BM-2302	417, 791	BM-2411	410, 648	BM-2653	430, 494
BM-2219	416	BM-2303	417, 791	BM-2420	410	BM-2654	430, 494
BM-2220	790	BM-2304	417, 791	BM-2430	415	BM-2655	430, 494
BM-2221	790	BM-2305	417, 791	BM-2431	415	BM-2656	494
BM-2222	790	BM-2306	417, 791	BM-2432	415	BM-2660	467
BM-2223	790	BM-2307	417, 791	BM-2433	415	BM-2661	467
BM-2224	790	BM-2308	417, 791	BM-2434	415	BM-2662	467
BM-2225	790	BM-2310	416	BM-2435	415	BM-2663	467
BM-2226	790	BM-2311	416	BM-2436	415	BM-2664	467
BM-2227	790	BM-2312	416	BM-2437	415	BM-2665	467
BM-2228	790	BM-2313	416	BM-2440	415	BM-2666	467
BM-2229	790	BM-2314	416	BM-2441	416	BM-2667	467
BM-2230	790	BM-2315	416	BM-2442	415	BM-2670	423
BM-2231	790	BM-2316	416	BM-2443	415	BM-2675	423, 580
BM-2232	790	BM-2317	416	BM-2444	415	BM-2680	423
BM-2233	790	BM-2318	416	BM-2445	415	BM-2685	423
BM-2234	790	BM-2319	416	BM-2446	415	BM-2690	424
BM-2235	790	BM-2320	416	BM-2447	415	BM-2700	426
BM-2236	790	BM-2321	416	BM-2448	415	BM-2710	424
BM-2237	790	BM-2322	416	BM-2449	415	BM-2720	424
BM-2238	417, 791	BM-2323	416	BM-2450	415	BM-2721	424
BM-2239	417, 791	BM-2324	416	BM-2460	415	BM-2730	425
BM-2240	417, 791	BM-2325	416	BM-2461	415	BM-2735	425
BM-2241	417, 791	BM-2326	416	BM-2462	415	BM-2736	425
BM-2242	417, 791	BM-2327	416	BM-2463	415	BM-2737	425
BM-2243	417, 791	BM-2328	416	BM-2464	415	BM-2738	425
BM-2244	417, 791	BM-2329	416	BM-2465	415	BM-2739	425
BM-2245	417, 791	BM-2330	416	BM-2466	415	BM-2740	495
BM-2246	417, 791	BM-2331	416	BM-2470	786	BM-2750	420, 422
BM-2250	416	BM-2332	417, 791	BM-2471	418, 786	BM-2751	420, 422
BM-2251	416	BM-2333	417, 791	BM-2472	418, 786	BM-2752	420, 422
BM-2252	416	BM-2334	417, 791	BM-2473	418, 786	BM-2753	420, 422
BM-2253	416	BM-2335	417, 791	BM-2474	418, 786	BM-2754	420, 422
BM-2254	416	BM-2336	417, 791	BM-2475	418, 786	BM-2755	422
BM-2260	417, 791	BM-2337	417, 791	BM-2476	418, 786	BM-2756	422
BM-2261	417, 791	BM-2338	417, 791	BM-2490	418, 786	BM-2757	421, 422
BM-2262	417, 791	BM-2339	417, 791	BM-2491	418, 786	BM-2758	425
BM-2263	417, 791	BM-2340	417, 791	BM-2494	418, 786	BM-2759	425
BM-2264	417, 791	BM-2351	417, 791	BM-2495	418, 786	BM-2760	425
BM-2265	417, 791	BM-2352	417, 791	BM-2496	418, 786	BM-2761	425
BM-2266	417, 791	BM-2353	417, 791	BM-2497	418, 786	BM-2780	420
BM-2267	417, 791	BM-2354	417, 791	BM-2498	418, 786	BM-2781	420
BM-2268	417, 791	BM-2355	417, 791	BM-2530	419, 787	BM-2782	420
BM-2270	416	BM-2356	417, 791	BM-2535	419, 787	BM-2783	420
BM-2271	416	BM-2357	417, 791	BM-2540	419, 787	BM-2784	421
BM-2272	416	BM-2358	417, 791	BM-2550	419, 787	BM-2785	421
BM-2273	416	BM-2359	417, 791	BM-2560	420	BM-2786	421
BM-2274	416	BM-2368	417, 791	BM-2561	420	BM-2787	421
BM-2275	416	BM-2369	417, 791	BM-2562	420	BM-2788	424
BM-2276	416	BM-2370	417, 791	BM-2563	420	BM-2789	425
BM-2277	416	BM-2371	417, 791	BM-2570	420	BM-2790	424, 425
BM-2278	416	BM-2372	417, 791	BM-2571	420	BM-2791	424, 425
BM-2279	416	BM-2373	417, 791	BM-2580	420	BM-2792	424, 425
BM-2280	416	BM-2374	417, 791	BM-2581	420	BM-2793	425
BM-2281	416	BM-2375	417, 791	BM-2582	420	BM-2794	425
BM-2282	416	BM-2383	417, 791	BM-2590	420	BM-2795	423
BM-2283	416	BM-2384	417, 791	BM-2591	420	BM-2800	428
BM-2284	416	BM-2385	417, 791	BM-2592	420	BM-2801	428
BM-2285	416	BM-2386	417, 791	BM-2593	420	BM-2802	428
BM-2286	417, 791	BM-2387	417, 791	BM-2594	420	BM-2803	428
BM-2287	417, 791	BM-2388	417, 791	BM-2600	421	BM-2804	428
BM-2288	417, 791	BM-2389	417, 791	BM-2601	421	BM-2805	428

Kat. No. Cat. No.	Sayfa Page	Kat. No. Cat. No.	Sayfa Page	Kat. No. Cat. No.	Sayfa Page	Kat. No. Cat. No.	Sayfa Page
BM-2806	428	BM-5401	466	BM-8203	585	BN-1718	760
BM-2807	428	BM-5403	466	BM-8204	585	BN-1719	760
BM-2808	428	BM-5404	466	BM-8205	585	BN-1720	760
BM-2809	428	BM-5405	466	BM-8206	585	BN-1721	761
BM-2810	428	BM-5406	466	BM-8700	586	BN-1722	761
BM-2820	428	BM-5500	508	BM-8701	586	BN-1725	762
BM-2821	428	BM-5600	508	BM-9110	586	BN-1726	762
BM-2830	426	BM-5701	508	BM-9111	586	BN-1750	763
BM-2831	426	BM-5702	508	BM-9112	586	BN-1751	763
BM-2832	426	BM-5703	508	BM-9113	586	BN-1752	763
BM-2833	426	BM-5704	508	BM-9114	586	BN-1753	763
BM-2840	427	BM-5800	509	BM-9130	587	BN-1754	763
BM-2841	427	BM-5901	509	BM-9131	587	BN-1800	763
BM-2842	427	BM-5902	509	BM-9140	590	BN-1801	763
BM-2843	427	BM-5903	509	BM-9141	590	BN-1802	763
BM-2844	427	BM-5904	509	BM-9142	590	BN-2000	780
BM-2845	427	BM-6001	509	BM-9143	590	BN-2001	780
BM-2846	427	BM-6002	509	BM-9320	589	BN-2002	780
BM-2847	427	BM-6003	509	BM-9321	589	BN-2003	780
BM-2848	427	BM-6101	510	BM-9322	589	BN-2004	780
BM-2849	427	BM-6102	510	BM-9323	589	BN-2005	780
BM-2850	427	BM-6103	510	BM-9324	589	BN-2006	780
BM-2851	427	BM-6200	509	BM-9325	589	BN-2007	780
BM-2852	427	BM-6301	510	BM-9326	589	BN-2008	782
BM-2853	427	BM-6302	510	BM-9327	589	BN-2009	782
BM-2860	429	BM-6303	510	BM-9328	589	BN-2010	781
BM-2861	429	BM-6304	510	BM-9329	589	BN-2011	781
BM-2862	429	BM-6305	510	BM-9401	588	BN-2014	781
BM-2863	429	BM-6306	510	BM-9403	588	BN-2015	781
BM-2864	429	BM-6401	511	BM-9404	588	BN-2016	782
BM-2865	429	BM-6501	511	BM-9406	588	BN-2017	782
BM-2866	429	BM-6502	511	BM-9407	588	BN-2100	783
BM-2867	429	BM-6601	511	BM-9408	588	BN-2101	783
BM-2868	429	BM-6602	511	BM-9409	588	BN-2102	596, 615
BM-2869	429	BM-6701	511	BM-9510	591	BN-2105	614
BM-2870	429	BM-6801	508	BM-9600	591	BN-2106	614
BM-2871	429	BM-6802	508	BM-9601	591	BN-2107	615
BM-2872	429	BM-6803	508	BM-9602	591	BN-2108	618
BM-2873	429	BM-6901	510	BM-9603	591	BN-2109	596, 618
BM-2874	429	BM-6902	510	BM-9604	591	BN-2110	596, 618
BM-2875	429	BM-6903	510	BM-9850	821	BN-2112	614
BM-3200	462	BM-7001	510	BM-9855	790	BN-2113	615
BM-3700	467	BM-7002	510	BM-9860	431	BN-2114	596, 614
BM-3800	467	BM-7100	580	BM-9861	431	BN-2115	614
BM-3900	462	BM-7101	580	BM-9862	431	BN-2116	840
BM-4001	462	BM-7102	580	BM-9863	431	BN-2117	615
BM-4002	462	BM-7103	580	BM-9880	431	BN-2118	615
BM-4003	462	BM-7104	580	BM-9881	588	BN-2119	616
BM-4004	462	BM-7105	580	BM-9882	588	BN-2120	616
BM-4100	463	BM-7106	580	BM-9883	588	BN-2121	616
BM-4200	463	BM-7200	580	BM-9884	588	BN-2122	616
BM-4300	463	BM-7300	581			BN-2123	615
BM-4400	463	BM-7400	581			BN-2124	616
BM-4500	464	BM-7600	581	BN-1701	596	BN-2125	616
BM-4600	464	BM-7700	581	BN-1702	596	BN-2128	617
BM-4700	464	BM-7800	582	BN-1703	596, 614	BN-2129	616
BM-4701	464	BM-7801	582	BN-1704	614	BN-2130	616
BM-4702	464	BM-7900	583	BN-1705	614	BN-2131	615
BM-4800	464	BM-8001	584	BN-1706	614	BN-2132	617
BM-4801	464	BM-8002	584	BN-1707	596, 759	BN-2133	617
BM-4802	464	BM-8003	584	BN-1708	596, 759	BN-2134	617
BM-4900	465	BM-8004	584	BN-1709	759	BN-2135	617
BM-4901	465	BM-8100	583	BN-1710	759	BN-2136	617
BM-4902	465	BM-8101	583	BN-1711	596, 761	BN-2137	616
BM-5001	465	BM-8102	583	BN-1712	761	BN-2138	617
BM-5100	465	BM-8103	583	BN-1713	762	BN-2139	619
BM-5101	465	BM-8104	583	BN-1714	761	BN-2140	615
BM-5200	466	BM-8200	585	BN-1715	615, 759	BN-2142	619
BM-5300	466	BM-8201	585	BN-1716	615, 760	BN-2143	619
BM-5400	466	BM-8202	585	BN-1717	760	BN-2144	619



Kat. No. Cat. No.	Sayfa Page	Kat. No. Cat. No.	Sayfa Page	Kat. No. Cat. No.	Sayfa Page	Kat. No. Cat. No.	Sayfa Page
BN-2145	618	BN-3408	621	BN-4812	625	BN-5165	647
BN-2146	620	BN-3409	621	BN-4813	635	BN-5166	647
BN-2147	620	BN-3415	625	BN-4814	635	BN-5175	788
BN-2148	618	BN-3420	625	BN-4815	635	BN-5176	788
BN-2206	619	BN-3505	597, 626	BN-4818	635	BN-5177	788
BN-2210	619	BN-3510	597, 626	BN-4819	635	BN-5178	788
BN-2212	619	BN-3515	597, 626	BN-5100	649	BN-5179	788
BN-2217	619	BN-3520	597, 626	BN-5101	649	BN-5180	788
BN-2332	620	BN-3525	597, 626	BN-5102	649	BN-5200	599
BN-2346	620	BN-3550	621	BN-5103	649	BN-5201	599
BN-2400	620	BN-3555	627	BN-5104	649	BN-5202	599
BN-2401	620	BN-3560	627	BN-5105	650	BN-5203	599
BN-2402	620	BN-3565	626	BN-5106	650	BN-5204	599
BN-2403	620	BN-3800	597, 626	BN-5107	650	BN-5205	599
BN-2542	620	BN-3801	596, 627	BN-5108	652	BN-5220	606
BN-2560	620	BN-3802	597, 627	BN-5109	653	BN-5230	656
BN-2580	620	BN-3803	597, 627	BN-5110	654	BN-5231	656
BN-2700	621	BN-3804	597, 627	BN-5111	652	BN-5236	656
BN-2750	621	BN-3805	597, 627	BN-5112	651	BN-5237	656
BN-2800	622	BN-3900	598, 632	BN-5113	651	BN-5238	656
BN-2801	622	BN-3901	598, 632	BN-5114	651	BN-5240	658
BN-2802	622	BN-3902	598, 632	BN-5115	651	BN-5244	779
BN-2900	622	BN-3903	598, 632	BN-5116	653	BN-5245	621
BN-2901	622	BN-3904	598, 632	BN-5117	654	BN-5304	659
BN-2902	622	BN-3905	598, 632	BN-5118	655	BN-5306	659
BN-2903	622	BN-4001	627	BN-5119	655	BN-5308	659
BN-2904	622	BN-4200	629	BN-5120	655	BN-5310	659
BN-3000	622	BN-4201	629	BN-5121	655	BN-5312	659
BN-3001	622	BN-4202	629	BN-5122	655	BN-5404	659
BN-3002	622	BN-4203	629	BN-5123	636	BN-5406	659
BN-3100	622	BN-4204	629	BN-5124	636	BN-5408	659
BN-3101	622	BN-4310	629	BN-5125	636	BN-5410	659
BN-3102	622	BN-4313	629	BN-5126	636	BN-5412	659
BN-3301	622	BN-4319	629	BN-5127	636	BN-5503	659
BN-3302	622	BN-4404	629	BN-5128	636	BN-5504	659
BN-3303	622	BN-4406	629	BN-5129	636	BN-5505	659
BN-3304	622	BN-4408	629	BN-5130	638	BN-5506	659
BN-3305	622	BN-4510	628	BN-5131	638	BN-5603	659
BN-3306	623	BN-4513	628	BN-5132	637	BN-5604	659
BN-3307	623	BN-4519	628	BN-5133	637	BN-5605	659
BN-3308	623	BN-4526	628	BN-5134	637	BN-5606	659
BN-3309	623	BN-4532	628	BN-5135	637	BN-5607	659
BN-3310	623	BN-4600	630	BN-5136	639	BN-5705	659
BN-3311	623	BN-4601	631	BN-5137	639	BN-5707	659
BN-3312	623	BN-4610	630	BN-5138	640	BN-5709	659
BN-3313	623	BN-4611	631	BN-5139	641	BN-5803	657
BN-3314	623	BN-4620	630	BN-5140	641	BN-5804	657
BN-3315	623	BN-4621	631	BN-5141	640	BN-5805	657
BN-3330	621	BN-4630	630	BN-5142	628	BN-5806	657
BN-3335	621	BN-4631	631	BN-5143	628	BN-5904	657
BN-3340	624	BN-4640	630	BN-5144	628	BN-5906	657
BN-3341	624	BN-4641	631	BN-5145	628	BN-5908	657
BN-3342	624	BN-4650	630	BN-5146	642	BN-5910	657
BN-3343	624	BN-4651	631	BN-5147	642	BN-5912	657
BN-3344	624	BN-4700	630	BN-5148	642	BN-6003	657
BN-3345	624	BN-4701	631	BN-5149	641	BN-6004	657
BN-3355	624	BN-4704	633	BN-5150	643	BN-6005	657
BN-3360	617	BN-4705	633	BN-5151	643	BN-6006	657
BN-3365	624	BN-4706	633	BN-5152	646	BN-6007	657
BN-3370	624	BN-4800	621	BN-5153	638	BN-6105	657
BN-3375	624	BN-4801	634	BN-5154	644	BN-6107	657
BN-3380	625	BN-4802	634	BN-5155	646	BN-6109	657
BN-3400	626	BN-4803	634	BN-5156	644	BN-6111	657
BN-3401	626	BN-4804	634	BN-5158	647	BN-6304	657
BN-3402	626	BN-4805	634	BN-5159	644	BN-6306	657
BN-3403	626	BN-4806	634	BN-5160	645	BN-6308	657
BN-3404	597, 625	BN-4808	634	BN-5161	645	BN-6310	657
BN-3405	625	BN-4809	634	BN-5162	645	BN-6312	657
BN-3406	625	BN-4810	634	BN-5163	645	BN-6404	657, 779
BN-3407	625	BN-4811	634	BN-5164	645	BN-6407	657, 779

Kat. No. Cat. No.	Sayfa Page	Kat. No. Cat. No.	Sayfa Page	Kat. No. Cat. No.	Sayfa Page	Kat. No. Cat. No.	Sayfa Page
BN-6409	657, 779	BN-7416	661	BN-8518	662	BN-9493	666
BN-6412	657, 779	BN-7419	661	BN-8525	662	BN-9500	668
BN-6415	657	BN-7422	661	BN-8530	662	BN-9501	668
BN-6420	657	BN-7425	661	BN-8538	662	BN-9502	668
BN-6504	658	BN-7428	661	BN-8555	662	BN-9503	668
BN-6506	658	BN-7432	661	BN-8568	662	BN-9505	822
BN-6508	658	BN-7438	661	BN-8570	662	BN-9506	822
BN-6550	658	BN-7506	661	BN-8580	662	BN-9507	822
BN-6553	658	BN-7513	661	BN-8605	662	BN-9510	822
BN-6555	658	BN-7519	661	BN-8610	662	BN-9511	822
BN-6564	658	BN-7525	661	BN-8616	662	BN-9512	822
BN-6566	658	BN-7532	661	BN-8625	662	BN-9513	822
BN-6575	659	BN-7606	661	BN-8626	662	BN-9514	822
BN-6578	659	BN-7613	661	BN-8650	662	BN-9515	822
BN-6583	659	BN-7619	661	BN-8660	662	BN-9520	669
BN-6584	659	BN-7625	661	BN-8670	662	BN-9521	669
BN-6590	659	BN-7632	661	BN-8801	663	BN-9522	669
BN-6591	659	BN-7706	661	BN-8811	663	BN-9526	669
BN-6592	659	BN-7713	661	BN-8821	663	BN-9527	669
BN-6604	659	BN-7719	661	BN-8831	663	BN-9528	669
BN-6606	659	BN-7725	661	BN-8841	663	BN-9529	669
BN-6608	659	BN-7732	661	BN-8851	663	BN-9530	669
BN-6610	659	BN-8027	661	BN-8861	663	BN-9532	669
BN-6612	659	BN-8031	661	BN-8871	663	BN-9534	669
BN-6615	659	BN-8034	661	BN-8881	663	BN-9536	669
BN-6710	659	BN-8037	661	BN-8891	663	BN-9537	669
BN-6712	659	BN-8039	661	BN-8896	663	BN-9538	669
BN-6714	659	BN-8045	661	BN-8901	663	BN-9540	669
BN-6716	659	BN-8052	661	BN-8911	663	BN-9541	669
BN-6810	660	BN-8066	661	BN-8921	663	BN-9542	669
BN-6812	660	BN-8069	661	BN-8931	663	BN-9543	669
BN-6815	660	BN-8073	661	BN-8941	663	BN-9583	7
BN-6820	660	BN-8076	661	BN-9005	663	BN-9584	7
BN-6825	660	BN-8079	661	BN-9007	663	BN-9585	7
BN-6908	660, 835	BN-8085	661	BN-9010	663	BN-9586	7
BN-6910	660, 835	BN-8092	661	BN-9015	663	BN-9600	671
BN-6912	660, 835	BN-8106	661	BN-9020	663	BN-9601	671
BN-6915	660, 835	BN-8109	661	BN-9025	663	BN-9602	671
BN-6920	660, 835	BN-8113	661	BN-9030	663	BN-9603	671
BN-6925	660, 835	BN-8116	661	BN-9105	663	BN-9604	671
BN-7010	660	BN-8119	661	BN-9107	663	BN-9605	671
BN-7012	660	BN-8125	661	BN-9110	663	BN-9635	671
BN-7015	660	BN-8132	661	BN-9115	663	BN-9650	671
BN-7020	660	BN-8136	661	BN-9120	663	BN-9651	671
BN-7025	660	BN-8139	661	BN-9125	663	BN-9655	671
BN-7110	660	BN-8143	661	BN-9130	663	BN-9735	673
BN-7112	660	BN-8146	661	BN-9201	664, 817	BN-9742	673
BN-7115	660	BN-8149	661	BN-9202	664	BN-9750	673
BN-7120	660	BN-8155	661	BN-9203	664	BN-9770	670
BN-7125	660	BN-8162	661	BN-9206	667	BN-9775	670
BN-7210	660	BN-8350	658	BN-9208	667	BN-9780	670
BN-7212	660	BN-8355	658	BN-9211	667	BN-9800	670, 788
BN-7215	660	BN-8363	658	BN-9216	667	BN-9801	670
BN-7220	660	BN-8365	658	BN-9245	664	BN-9810	672, 779
BN-7225	660	BN-8373	658	BN-9250	664	BN-9820	672
BN-7250	660	BN-8375	658	BN-9255	664	BN-9830	672
BN-7255	660	BN-8404	662	BN-9440	665	BN-9850	672, 835
BN-7306	661	BN-8408	662	BN-9441	665	BN-9855	673
BN-7310	661	BN-8410	662	BN-9450	665	BN-9900	672
BN-7313	661	BN-8413	662	BN-9451	665	BN-9910	673
BN-7316	661	BN-8415	662	BN-9469	664	BN-9920	673
BN-7319	661	BN-8418	662	BN-9470	666	BN-9950	670
BN-7322	661	BN-8420	662	BN-9471	666	BN-9955	670
BN-7325	661	BN-8425	662	BN-9472	666		
BN-7328	661	BN-8430	662	BN-9473	666		
BN-7332	661	BN-8438	662	BN-9474	666	BP-1600	762
BN-7338	661	BN-8444	662	BN-9475	666	BP-1601	762
BN-7406	661	BN-8450	662	BN-9490	667	BP-1602	763
BN-7410	661	BN-8508	662	BN-9491	667	BP-1603	781
BN-7413	661	BN-8513	662	BN-9492	668	BP-1604	781



Kat. No. Cat. No.	Sayfa Page	Kat. No. Cat. No.	Sayfa Page	Kat. No. Cat. No.	Sayfa Page	Kat. No. Cat. No.	Sayfa Page
BP-1605	783	BP-2304	678	BP-2504	681	BP-3207	686
BP-1606	783	BP-2305	678	BP-2505	681	BP-3208	686
BP-1607	783	BP-2306	678	BP-2506	681	BP-3209	693
BP-1610	784	BP-2307	678	BP-2507	681	BP-3210	693
BP-1615	784	BP-2308	678	BP-2508	681	BP-3220	693
BP-1630	784	BP-2309	678	BP-2510	681	BP-3300	689
BP-1635	784	BP-2310	678	BP-2511	681	BP-3301	689
BP-1660	785	BP-2311	678	BP-2512	681	BP-3302	689
BP-1661	785	BP-2312	678	BP-2513	681	BP-3303	689
BP-1662	785	BP-2313	678	BP-2514	681	BP-3304	689
BP-2110	676	BP-2350	679	BP-2515	681	BP-3400	687
BP-2111	676	BP-2351	679	BP-2516	681	BP-3401	687
BP-2112	676	BP-2352	679	BP-2517	681	BP-3402	687
BP-2113	676	BP-2353	679	BP-2518	681	BP-3403	687
BP-2114	676	BP-2354	679	BP-2520	681	BP-3404	687
BP-2115	676	BP-2355	679	BP-2521	681	BP-3405	687
BP-2116	676	BP-2356	679	BP-2522	681	BP-3406	687
BP-2117	676	BP-2357	679	BP-2523	681	BP-3407	687
BP-2118	676	BP-2358	679	BP-2524	681	BP-3500	690
BP-2119	676	BP-2359	679	BP-2525	681	BP-3501	690
BP-2120	676	BP-2360	679	BP-2526	681	BP-3510	690
BP-2121	676	BP-2361	679	BP-2527	681	BP-3511	690
BP-2122	676	BP-2370	679	BP-2528	681	BP-3520	690
BP-2123	677	BP-2371	679	BP-2530	682	BP-3540	690
BP-2124	677	BP-2372	679	BP-2531	682	BP-3541	690
BP-2200	677	BP-2373	679	BP-2532	682	BP-3550	690
BP-2201	677	BP-2374	679	BP-2533	682	BP-3600	690
BP-2202	677	BP-2375	679	BP-2534	682	BP-3601	690
BP-2203	677	BP-2380	679	BP-2535	682	BP-3610	691
BP-2204	677	BP-2381	679	BP-2536	682	BP-3611	691
BP-2205	677	BP-2382	679	BP-2537	682	BP-3612	691
BP-2206	677	BP-2383	679	BP-2538	682	BP-3620	691
BP-2210	677	BP-2384	679	BP-2540	682	BP-3621	691
BP-2211	677	BP-2385	679	BP-2541	682	BP-3650	691
BP-2225	840	BP-2400	679	BP-2542	682	BP-3800	692
BP-2230	840	BP-2401	679	BP-2543	682	BP-3801	692
BP-2240	840	BP-2402	679	BP-2544	682	BP-3802	692
BP-2241	840	BP-2403	679	BP-2545	682	BP-3803	692
BP-2242	840	BP-2404	679	BP-2546	682	BP-3804	693
BP-2243	840	BP-2405	679	BP-2547	682	BP-3810	691
BP-2251	840	BP-2410	680	BP-2548	682	BP-3815	5
BP-2252	840	BP-2411	680	BP-2550	682	BP-3820	691
BP-2253	840	BP-2412	680	BP-2551	682	BP-4306	479
BP-2254	840	BP-2413	680	BP-2552	682	BP-4307	479
BP-2255	840	BP-2420	680	BP-2553	682	BP-4308	479
BP-2256	840	BP-2421	680	BP-2554	682	BP-4309	479
BP-2260	683	BP-2422	680	BP-2555	682	BP-4400	479
BP-2261	683	BP-2423	680	BP-2556	682	BP-4401	479
BP-2262	683	BP-2424	680	BP-2557	682	BP-4402	479
BP-2263	683	BP-2430	680	BP-2558	682	BP-4403	479
BP-2265	683	BP-2431	680	BP-2560	682	BP-4404	479
BP-2270	683	BP-2432	680	BP-2561	682	BP-4405	479
BP-2280	678	BP-2440	683	BP-2562	682	BP-4406	479
BP-2281	678	BP-2441	683	BP-2563	682	BP-4407	479
BP-2282	678	BP-2442	683	BP-2564	682	BP-4500	684
BP-2283	678	BP-2450	680	BP-2565	682	BP-4501	684
BP-2284	678	BP-2451	680	BP-2566	682	BP-4502	684
BP-2285	678	BP-2452	680	BP-2567	682	BP-4503	684
BP-2286	678	BP-2453	680	BP-2568	682	BP-4504	684
BP-2287	678	BP-2460	680	BP-2800	686	BP-4600	684
BP-2288	678	BP-2461	680	BP-2801	686	BP-4601	684
BP-2289	678	BP-2462	680	BP-2802	686	BP-4602	684
BP-2290	678	BP-2463	680	BP-2803	686	BP-4603	684
BP-2291	678	BP-2470	680	BP-3200	687	BP-4604	684
BP-2292	678	BP-2471	680	BP-3201	687	BP-4700	684
BP-2293	678	BP-2472	680	BP-3202	687	BP-4701	684
BP-2300	678	BP-2500	681	BP-3203	687	BP-4702	684
BP-2301	678	BP-2501	681	BP-3204	687	BP-4703	684
BP-2302	678	BP-2502	681	BP-3205	687	BP-4704	684
BP-2303	678	BP-2503	681	BP-3206	686	BP-4800	684

Kat. No. Cat. No.	Sayfa Page	Kat. No. Cat. No.	Sayfa Page	Kat. No. Cat. No.	Sayfa Page	Kat. No. Cat. No.	Sayfa Page
BP-4801	684	BP-6723	557	BR-1400	696	BR-3880	710
BP-4802	684	BP-6808	557	BR-1410	696	BR-3885	710
BP-4803	684	BP-6810	557	BR-1420	696	BR-3890	711
BP-4804	684	BP-6812	557	BR-1500	697	BR-3900	710
BP-4900	684	BP-6814	557	BR-1501	697	BR-3901	710
BP-4901	684	BP-6815	557	BR-1600	697	BR-3920	711
BP-4902	684	BP-6816	557	BR-1700	698	BR-3921	711
BP-4903	684	BP-6818	557	BR-1801	697	BR-3925	708
BP-4904	684	BP-6819	557	BR-1803	697	BR-3940	711
BP-5000	684	BP-6907	557	BR-1804	697	BR-3941	711
BP-5001	684	BP-6908	557	BR-1900	699	BR-3945	712
BP-5002	684	BP-6910	557	BR-1901	699	BR-3950	712
BP-5003	684	BP-6912	557	BR-2020	698	BR-3955	712
BP-5004	684	BP-6914	557	BR-2200	608, 699, 835	BR-3960	713
BP-5100	684	BP-6915	557	BR-2201	608, 699	BR-3961	713
BP-5101	684	BP-6916	557	BR-2250	698	BR-3965	713
BP-5102	684	BP-6918	557	BR-2255	700	BR-3970	713
BP-5103	684	BP-6919	557	BR-2300	700	BR-3975	713
BP-5104	684	BP-6921	557	BR-2301	700	BR-3980	713
BP-5200	684	BP-6923	557	BR-2450	700	BR-3985	713
BP-5201	684	BP-7007	558	BR-2455	700	BR-3990	713
BP-5202	684	BP-7008	558	BR-2460	700, 835	BR-4001	714
BP-5203	684	BP-7010	558	BR-2465	701	BR-4002	714
BP-5204	684	BP-7012	558	BR-2470	701	BR-4010	714
BP-5300	685	BP-7014	558	BR-2475	701	BR-4011	714
BP-5301	685	BP-7015	558	BR-2600	702	BR-4015	714
BP-5302	685	BP-7107	558	BR-2610	702	BR-4020	714
BP-5400	685	BP-7108	558	BR-2620	703	BR-4030	715
BP-5401	685	BP-7110	558	BR-2621	703	BR-4040	715
BP-5402	685	BP-7112	558	BR-2630	703	BR-4045	715
BP-5500	685	BP-7114	558	BR-2700	704	BR-4050	715
BP-5501	685	BP-7115	558	BR-2701	704	BR-4055	712
BP-5502	685	BP-7207	558	BR-2702	705	BR-4060	611, 716
BP-5600	685	BP-7208	558	BR-3010	705	BR-4065	716
BP-5601	685	BP-7210	558	BR-3011	705	BR-4070	712
BP-5602	685	BP-7212	558	BR-3012	705	BR-4080	712
BP-5700	685	BP-7214	558	BR-3013	705	BR-4090	611, 717
BP-5701	685	BP-7215	558	BR-3014	705	BR-4091	611, 717
BP-5702	685	BP-7316	558	BR-3100	705	BR-4100	717
BP-5800	685	BP-7318	558	BR-3101	705	BR-4313	718
BP-5801	685	BP-7319	558	BR-3102	705	BR-4317	718
BP-5802	685	BP-7321	558	BR-3103	705	BR-4320	718
BP-6400	556, 688	BP-7323	558	BR-3200	706	BR-4330	718
BP-6401	556, 688	BP-7326	558	BR-3201	706	BR-4400	718
BP-6402	556, 688	BP-7328	558	BR-3202	706	BR-4401	718
BP-6403	556, 688	BP-7400	559	BR-3300	706	BR-4402	718
BP-6404	556, 688	BP-7401	559	BR-3301	706	BR-4403	718
BP-6405	556, 688	BP-7500	559	BR-3400	707	BR-4410	718
BP-6500	556, 688	BP-7501	559	BR-3401	707	BR-4411	718
BP-6501	556, 688	BP-7502	559	BR-3410	707	BR-4412	718
BP-6502	556, 688	BP-7503	559	BR-3420	707	BR-4500	719
BP-6503	556, 688	BP-7504	559	BR-3450	707	BR-4501	719
BP-6504	556, 688	BP-7600	560	BR-3804	708	BR-4510	719
BP-6505	556, 688	BP-7700	560	BR-3810	708	BR-4515	719
BP-6600	556, 688	BP-7710	560	BR-3811	708	BR-4520	719
BP-6601	556, 688	BP-7720	560	BR-3820	708	BR-4521	719
BP-6602	556, 688	BP-7730	550	BR-3821	708	BR-4530	720
BP-6603	556, 688	BP-7740	502, 550	BR-3825	709	BR-4531	720
BP-6604	556, 688	BP-7750	550	BR-3830	709	BR-4532	720
BP-6704	557	BP-7780	550	BR-3835	709	BR-4540	610, 721
BP-6707	557	BP-7785	550	BR-3836	709	BR-4545	610, 721
BP-6708	557	BP-7790	550	BR-3840	709	BR-4600	722
BP-6710	557	BP-7825	689	BR-3841	709	BR-4601	722
BP-6712	557	BP-7827	689	BR-3845	708	BR-4703	722
BP-6714	557	BP-7832	689	BR-3850	708	BR-4704	722
BP-6715	557			BR-3855	709	BR-4705	722
BP-6716	557			BR-3860	709	BR-4713	723
BP-6718	557	BR-1300	696	BR-3870	710	BR-4714	723
BP-6719	557	BR-1310	696	BR-3871	710	BR-4723	723
BP-6721	557	BR-1320	696	BR-3875	711	BR-4724	723



Kat. No. Cat. No.	Sayfa Page	Kat. No. Cat. No.	Sayfa Page	Kat. No. Cat. No.	Sayfa Page	Kat. No. Cat. No.	Sayfa Page
BR-4734	723	BR-7820	609	BR-8904	727	BR-9944	726
BR-4743	724	BR-7830	606	BR-8905	727	BR-9945	726
BR-4755	724	BR-7840	609	BR-8906	727	BR-9951	726
BR-4901	729	BR-7851	609, 835	BR-9001	727	BR-9952	726
BR-4902	729	BR-7860	609	BR-9002	727	BR-9953	726
BR-4903	729	BR-7865	609	BR-9003	727	BR-9954	726
BR-4904	729	BR-7880	500	BR-9004	727	BR-9955	726
BR-4905	729	BR-7881	500	BR-9005	727	BR-9961	726
BR-4906	729	BR-7890	748	BR-9006	727	BR-9962	726
BR-5001	727	BR-7891	748	BR-9102	727	BR-9963	726
BR-5002	727	BR-7895	749	BR-9103	727	BR-9964	726
BR-5003	727	BR-7896	749	BR-9104	727	BR-9965	726
BR-5004	727	BR-7897	749	BR-9105	727	BR-9972	726
BR-5005	727	BR-7900	748	BR-9201	727	BR-9973	726
BR-5006	727	BR-7901	748	BR-9202	727	BR-9974	726
BR-5101	728	BR-7910	779	BR-9203	727	BR-9975	726
BR-5102	728	BR-8000	797	BR-9204	727	BR-9982	726
BR-5103	728	BR-8002	797	BR-9205	727	BR-9983	726
BR-5104	728	BR-8005	797	BR-9206	727	BR-9984	726
BR-5105	728	BR-8010	797	BR-9302	727	BR-9985	726
BR-5201	727	BR-8015	797	BR-9303	727	BR-9991	728
BR-5202	727	BR-8020	802	BR-9304	727	BR-9992	728
BR-5203	727	BR-8025	803	BR-9305	727	BR-9993	728
BR-5204	727	BR-8100	803	BR-9401	726	BR-9994	728
BR-5205	727	BR-8101	803	BR-9402	726	BR-9995	728
BR-5206	727	BR-8102	803	BR-9403	726		
BR-5301	729	BR-8103	803	BR-9404	726		
BR-5302	729	BR-8104	803	BR-9405	726	BS-2270	732
BR-5303	729	BR-8110	803, 815	BR-9406	726	BS-2280	732
BR-5304	729	BR-8200	804	BR-9501	726	BS-2281	732
BR-5305	729	BR-8201	804	BR-9502	726	BS-2282	732
BR-5501	728	BR-8202	804	BR-9503	726	BS-2285	732
BR-5502	728	BR-8203	804	BR-9504	726	BS-2290	733
BR-5503	728	BR-8210	804	BR-9505	726	BS-2291	733
BR-5504	728	BR-8220	804	BR-9506	726	BS-2292	733
BR-5505	728	BR-8225	804	BR-9602	726	BS-2293	733
BR-5702	725	BR-8230	803	BR-9603	726	BS-2300	733
BR-5703	725	BR-8240	805	BR-9604	726	BS-2310	733
BR-5704	725	BR-8250	805	BR-9605	726	BS-2311	734
BR-5705	725	BR-8255	805	BR-9606	726	BS-2320	735
BR-5802	725	BR-8260	806	BR-9702	726	BS-2350	736
BR-5803	725	BR-8265	806	BR-9703	726	BS-2352	735
BR-5804	725	BR-8270	806	BR-9704	726	BS-2360	733
BR-5805	725	BR-8275	807, 815	BR-9705	726	BS-2500	735
BR-5902	729	BR-8300	807	BR-9706	726	BS-2501	735
BR-5903	729	BR-8310	806	BR-9802	726	BS-2502	735
BR-5904	729	BR-8320	807	BR-9803	726	BS-2503	735
BR-5905	729	BR-8330	808	BR-9804	726	BS-2504	735
BR-5906	729	BR-8340	808	BR-9805	726	BS-2510	735
BR-6055	724	BR-8400	807	BR-9902	726	BS-2511	735
BR-6101	729	BR-8401	806	BR-9903	726	BS-2512	735
BR-6102	729	BR-8410	808	BR-9904	726	BS-2602	739
BR-6103	729	BR-8411	808	BR-9905	726	BS-2603	739
BR-6104	729	BR-8412	809	BR-9911	728	BS-2704	739
BR-6105	729	BR-8413	809	BR-9912	728	BS-2802	738
BR-6902	729	BR-8500	818	BR-9913	728	BS-2803	738
BR-6903	729	BR-8501	818	BR-9914	728	BS-2804	738
BR-6904	729	BR-8510	818	BR-9915	728	BS-2805	738
BR-6905	729	BR-8511	818	BR-9922	728	BS-2902	738
BR-7402	729	BR-8600	824	BR-9923	728	BS-2903	738
BR-7403	729	BR-8601	824	BR-9924	728	BS-2904	738
BR-7404	729	BR-8700	817	BR-9925	728	BS-3002	738
BR-7405	729	BR-8800	5	BR-9931	726	BS-3003	738
BR-7502	728	BR-8801	5	BR-9932	726	BS-3004	738
BR-7503	728	BR-8802	815	BR-9933	726	BS-3102	739
BR-7504	728	BR-8803	824	BR-9934	726	BS-3203	739
BR-7505	728	BR-8804	824	BR-9935	726	BS-3303	739
BR-7700	778	BR-8901	727	BR-9941	726	BS-3403	739
BR-7800	609	BR-8902	727	BR-9942	726	BS-3504	739
BR-7801	609	BR-8903	727	BR-9943	726	BS-3604	739

Kat. No. Cat. No.	Sayfa Page	Kat. No. Cat. No.	Sayfa Page	Kat. No. Cat. No.	Sayfa Page	Kat. No. Cat. No.	Sayfa Page
BS-3704	739	BS-5690	554	BT-1503	746	BT-1820	799
BS-3802	741	BS-5700	554	BT-1630	746	BT-1822	799
BS-3803	741	BS-5720	555	BT-1631	746	BT-1930	799
BS-3804	741	BS-5750	468, 555	BT-1640	746	BT-1931	799
BS-3805	741	BS-5751	468	BT-1700	770	BT-1932	799
BS-3806	741	BS-5760	555	BT-1701	770	BT-1933	798
BS-3902	741	BS-5761	555	BT-1702	774	BT-1935	799
BS-3903	741	BS-5780	555	BT-1703	770	BT-1937	799
BS-3904	741	BS-5781	555	BT-1704	774	BT-1938	799
BS-3905	741	BS-5820	555	BT-1705	774	BT-1940	798
BS-3906	741	BS-5880	823	BT-1706	774	BT-1942	798
BS-4002	741	BS-6010	468, 555	BT-1708	770	BT-1944	798
BS-4003	741	BS-6020	555	BT-1709	770	BT-1946	798
BS-4004	741	BS-6100	502	BT-1710	770	BT-1948	798
BS-4005	741	BS-6300	468	BT-1711	770, 774		
BS-4006	741	BS-6310	469	BT-1712	770, 774		
BS-4103	741	BS-6320	468	BT-1713	771	BV-1100	409
BS-4104	741	BS-6330	469	BT-1714	771	BV-1120	409
BS-4105	741	BS-6335	468	BT-1715	771, 773	BV-1121	409
BS-4203	741	BS-6340	469	BT-1716	771	BV-1630	467
BS-4204	741	BS-6350	469	BT-1717	771, 773	BV-1700	754
BS-4205	741	BS-6360	469	BT-1718	771	BV-1705	754
BS-4303	741	BS-6370	469	BT-1719	771	BV-1800	204
BS-4304	741	BS-6400	469, 554	BT-1720	771, 773	BV-1805	204, 755
BS-4305	741	BS-6401	469, 554	BT-1721	773	BV-1810	782
BS-4403	741	BS-6800	469	BT-1722	773	BV-1820	755, 826
BS-4404	741	BS-6900	604	BT-1723	774	BV-1900	826
BS-4503	741	BS-7030	605	BT-1725	772	BV-1901	826
BS-4504	741	BS-7031	605	BT-1726	773	BV-1923	826
BS-4603	741	BS-7032	605	BT-1727	773	BV-1925	826
BS-4604	741	BS-7033	605	BT-1728	773	BV-2200	3
BS-4705	742	BS-7041	605	BT-1730	772	BV-2525	832
BS-4710	742	BS-7042	605	BT-1731	772	BV-2535	769
BS-4715	742	BS-7043	605	BT-1732	772	BV-2540	769
BS-4727	740	BS-7051	605	BT-1733	772	BV-2545	769
BS-4732	740	BS-7052	605	BT-1736	773	BV-2550	769
BS-4743	740	BS-7053	605	BT-1740	776	BV-2555	769
BS-4749	740	BS-7330	605	BT-1741	776	BV-2560	769
BS-4752	740	BS-7340	605	BT-1742	776	BV-2600	769
BS-4762	736	BS-7350	605	BT-1743	776	BV-2601	769
BS-4804	737			BT-1744	776	BV-2602	769
BS-4805	737			BT-1745	776	BV-2603	769
BS-4806	737	BT-1100	208	BT-1746	776	BV-2604	769
BS-4903	737	BT-1110	208	BT-1748	776	BV-2605	769
BS-4904	737	BT-1120	208	BT-1750	776	BV-2606	769
BS-4905	737	BT-1130	208	BT-1751	776	BV-2607	769
BS-5003	737	BT-1140	208	BT-1752	776	BV-2608	769
BS-5004	737	BT-1141	208	BT-1758	776	BV-2609	769
BS-5103	736	BT-1142	208	BT-1760	777	BV-2610	769
BS-5105	742	BT-1150	209	BT-1765	777	BV-2611	769
BS-5110	742	BT-1160	209	BT-1770	777	BV-2612	769
BS-5115	743	BT-1170	209	BT-1775	777	BV-2613	769
BS-5131	743	BT-1180	209	BT-1780	777	BV-2653	698, 799
BS-5132	743	BT-1190	209, 845	BT-1785	777	BV-2663	698
BS-5133	743	BT-1195	209	BT-1788	777	BV-2670	529
BS-5141	743	BT-1200	209	BT-1790	777	BV-2675	529
BS-5600	551	BT-1210	209	BT-1795	777	BV-2715	546
BS-5605	551	BT-1220	209	BT-1797	777	BV-2719	546
BS-5610	551	BT-1230	209	BT-1798	777	BV-2720	547
BS-5611	551	BT-1310	210	BT-1800	798	BV-2727	547
BS-5620	551	BT-1320	211, 845	BT-1801	798	BV-2735	548
BS-5621	551	BT-1330	211, 845	BT-1802	798	BV-2740	501
BS-5630	551	BT-1340	845	BT-1810	799	BV-2741	501
BS-5631	551	BT-1400	211, 845	BT-1811	799	BV-2816	789
BS-5640	551	BT-1450	210	BT-1812	799	BV-2827	575
BS-5650	553	BT-1460	210	BT-1813	799	BV-2912	501
BS-5651	553	BT-1470	210, 845	BT-1814	799	BV-2916	501
BS-5660	553	BT-1500	746	BT-1815	799	BV-2920	501
BS-5670	554	BT-1501	746	BT-1816	799	BV-3012	789
BS-5680	553	BT-1502	746	BT-1817	799	BV-3014	789



Kat. No. Cat. No.	Sayfa Page	Kat. No. Cat. No.	Sayfa Page	Kat. No. Cat. No.	Sayfa Page	Kat. No. Cat. No.	Sayfa Page
BV-3016	789	BV-4043	768			BY-2944	817
BV-3018	789	BV-4044	768			BY-2945	817
BV-3112	789	BV-4045	768	BY-1130	747	BY-2965	817
BV-3114	789	BV-4115	795	BY-1131	747	BY-3106	820
BV-3116	789	BV-4118	832	BY-1132	747	BY-3107	820
BV-3118	789	BV-4120	832	BY-1135	747	BY-3108	820
BV-3120	789	BV-4123	832	BY-1136	747	BY-3109	820
BV-3212	789	BV-4124	832	BY-1209	747	BY-3110	820
BV-3214	789	BV-4127	832	BY-1214	747	BY-3111	820
BV-3216	789	BV-4129	832	BY-1215	747	BY-3112	820
BV-3218	789	BV-4134	832	BY-1216	747	BY-3113	820
BV-3220	789	BV-4142	833	BY-1220	747	BY-3114	820
BV-3221	789	BV-4204	833	BY-1222	747	BY-3115	820
BV-3225	789	BV-4206	833	BY-1310	747	BY-3116	820
BV-3230	789	BV-4208	833	BY-1315	747	BY-3206	820
BV-3235	789	BV-4210	833	BY-1331	747	BY-3207	820
BV-3240	789	BV-4212	833	BY-1332	747	BY-3208	820
BV-3310	789	BV-4215	833	BY-1336	747	BY-3209	820
BV-3313	789	BV-4218	833	BY-1337	747	BY-3210	820
BV-3316	789	BV-4220	833	BY-1442	812	BY-3211	820
BV-3412	789	BV-4239	833	BY-1505	812	BY-3212	820
BV-3414	789	BV-4306	833	BY-1508	812	BY-3213	820
BV-3416	789	BV-4308	833	BY-1515	811	BY-3214	820
BV-3420	789	BV-4312	833	BY-1518	811	BY-3215	820
BV-3513	789	BV-4318	833	BY-1520	812	BY-3216	820
BV-3516	789	BV-4320	833	BY-1521	811	BY-3406	823
BV-3520	789	BV-4330	814	BY-1525	812, 813	BY-3408	823
BV-3531	470	BV-4422	816	BY-1530	812	BY-3410	823
BV-3600	471	BV-4427	816	BY-1535	813	BY-3415	815
BV-3610	471	BV-4435	816	BY-1540	662	BY-3425	815
BV-3611	471	BV-4436	816	BY-1545	811	BY-3430	815
BV-3620	471	BV-4437	816	BY-1546	812	BY-3431	815
BV-3625	471	BV-4440	816	BY-1547	812	BY-3432	815
BV-3626	471	BV-4560	821	BY-1690	813	BY-3433	815
BV-3627	471	BV-4566	821	BY-1695	813	BY-3504	604
BV-3628	471	BV-4567	821	BY-1725	814	BY-3505	604
BV-3630	470	BV-4568	821	BY-1735	814	BY-3506	604
BV-3631	470	BV-4569	822	BY-1825	814	BY-3510	825
BV-3632	470	BV-4570	822	BY-1835	814	BY-3515	825
BV-3633	470	BV-4571	823	BY-1850	814		
BV-3635	470	BV-4572	823	BY-1855	814		
BV-3640	749, 810, 832	BV-4573	823	BY-1860	814	BZ-1102	853
BV-3730	749, 810, 832	BV-4574	823	BY-1865	814	BZ-1103	848
BV-3740	749, 810, 832	BV-4575	820	BY-1870	814	BZ-1116	853
BV-3750	749, 810, 832	BV-4580	824	BY-1875	814	BZ-1120	853
BV-3830	749, 810, 832	BV-4581	824	BY-1880	814	BZ-1123	853
BV-3840	749, 810, 832	BV-4602	827	BY-1885	814	BZ-1125	853
BV-3843	748	BV-4603	827	BY-2161	414, 778	BZ-1130	853
BV-3850	749, 810, 832	BV-4604	827	BY-2162	790	BZ-1216	853
BV-3855	749	BV-4606	827	BY-2227	814	BZ-1220	853
BV-3860	748	BV-4615	827	BY-2235	814	BZ-1223	853
BV-3870	752	BV-4616	827	BY-2240	814	BZ-1225	853
BV-3915	752	BV-4617	827	BY-2245	814	BZ-1230	853
BV-3919	753	BV-4710	388, 524	BY-2315	814	BZ-1235	853
BV-4013	768	BV-4715	388	BY-2322	814	BZ-1240	853
BV-4014	768	BV-4720	524	BY-2535	817	BZ-1245	853
BV-4015	768	BV-4725	798	BY-2545	817	BZ-1250	853
BV-4030	768	BV-4730	798	BY-2565	817	BZ-1255	848
BV-4031	768	BV-4735	798	BY-2735	817	BZ-1256	848
BV-4032	768	BV-4740	821	BY-2745	817	BZ-1257	848
BV-4033	768	BV-4755	608	BY-2765	817	BZ-1258	848
BV-4034	768	BV-4756	608	BY-2800	812	BZ-1259	848
BV-4035	768	BV-4757	608	BY-2835	817	BZ-1260	499
BV-4036	768	BV-4758	608	BY-2845	817	BZ-1300	850
BV-4037	768	BV-4800	831	BY-2865	817	BZ-1301	850
BV-4038	768	BV-4801	391, 831	BY-2925	817	BZ-1302	850
BV-4039	768	BV-4810	834	BY-2926	817	BZ-1303	850
BV-4040	768	BV-4815	834	BY-2927	817	BZ-1304	850
BV-4041	768	BV-4820	417, 790, 791	BY-2935	817	BZ-1305	850
BV-4042	768	BV-4830	414	BY-2940	817	BZ-1306	850

Kat. No. Cat. No.	Sayfa Page	Kat. No. Cat. No.	Sayfa Page	Kat. No. Cat. No.	Sayfa Page	Kat. No. Cat. No.	Sayfa Page
BZ-1307	850	CN-7010	527				
BZ-1308	850	CN-8120	856				
BZ-1309	850	CN-8121	856				
BZ-1310	850	CN-8122	856				
BZ-1311	850	CN-8123	856				
BZ-1312	850	CN-8124	856				
BZ-1313	850	CN-8126	856				
BZ-1314	850	CN-8127	856				
BZ-1315	850	CN-8128	856				
BZ-1316	850	CN-8129	856				
BZ-1317	850	CN-8130	856				
BZ-1318	850	CN-8131	856				
BZ-1319	850	CN-8132	856				
BZ-1320	850	CN-8133	856				
BZ-1321	850	CN-8134	856				
BZ-1322	850						
BZ-1323	850						
BZ-1324	850						
BZ-1325	850						
BZ-1326	850						
BZ-1327	850						
BZ-1328	850						
BZ-1329	850						
BZ-1334	849						
BZ-1335	849						
BZ-1337	849						
BZ-1338	849						
BZ-1339	849						
BZ-1342	852						
BZ-1343	852						
BZ-1344	852						
BZ-1350	852						
BZ-1353	851						
BZ-1354	851						
BZ-1355	851						
BZ-1356	851						
BZ-1357	851						
BZ-1358	851						
BZ-1359	851						
BZ-1360	851						
BZ-1361	851						
BZ-1362	851						
BZ-1363	851						
BZ-1364	851						
BZ-1365	851						
BZ-1366	851						
BZ-1367	851						
BZ-1390	851						
BZ-1391	851						
BZ-1392	851						
BZ-1393	851						
BZ-1394	851						
BZ-1395	851						
CN-2482	528						
CN-2483	528						
CN-2600	527						
CN-2601	527						
CN-2602	527						
CN-2604	527						
CN-2605	527						
CN-3740	528						
CN-3741	528						
CN-3742	528						
CN-3743	528						
CN-3752	528						
CN-3753	528						
CN-3754	528						
CN-3755	528						

