

CATALOGUE 2022

BASKETS &
PERFORATED
TRAYS

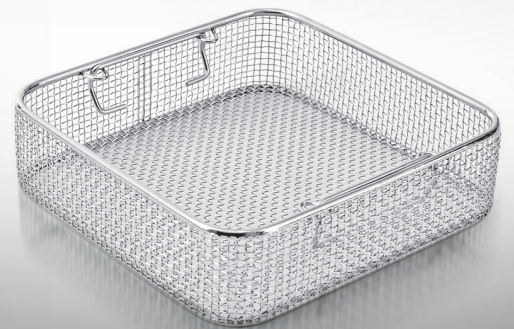
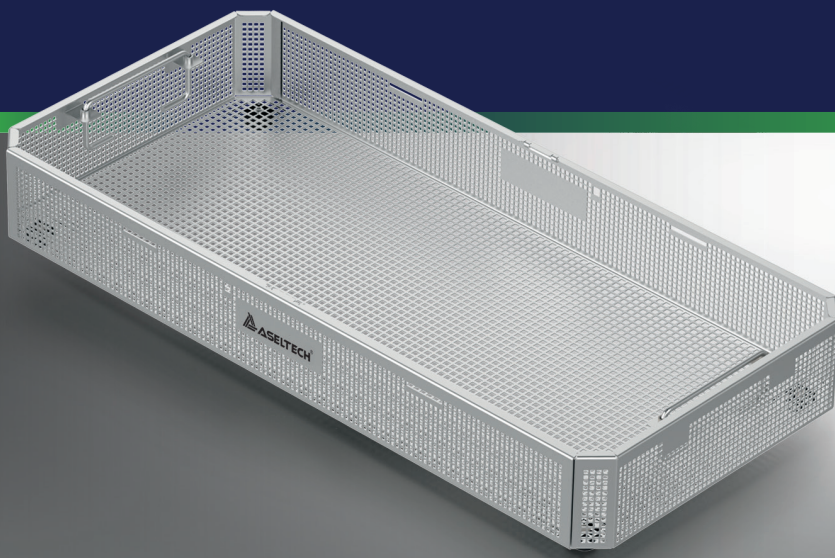

 **ASELTECH**[®]

“To the heart of life...”

BASKETS

The baskets are the main supplementary components of container systems and they are necessary for a full set container. ASELTECH has focused on 3 main model in basket production. Two of these models are wire basket and perforated sheet basket. The third model is a combination of these two models with perforated metal plates on sides and with wire mesh on bottom. ASELTECH has the model and sizes of baskets in its standard production appealing to all container model and sizes. Also, it ensures basket production in demanded sizes besides standard production.

The standard diameter of the wire used in basket production is 1 mm and mesh distance is 4 mm. But this distance can also be arranged according to the special demands. Besides, ASELTECH manufactures fine mesh baskets for small instruments, laundry baskets and endoscopic baskets. These baskets can also be produced in demanded sizes and mesh distances.

Please contact our company for any special production basket.

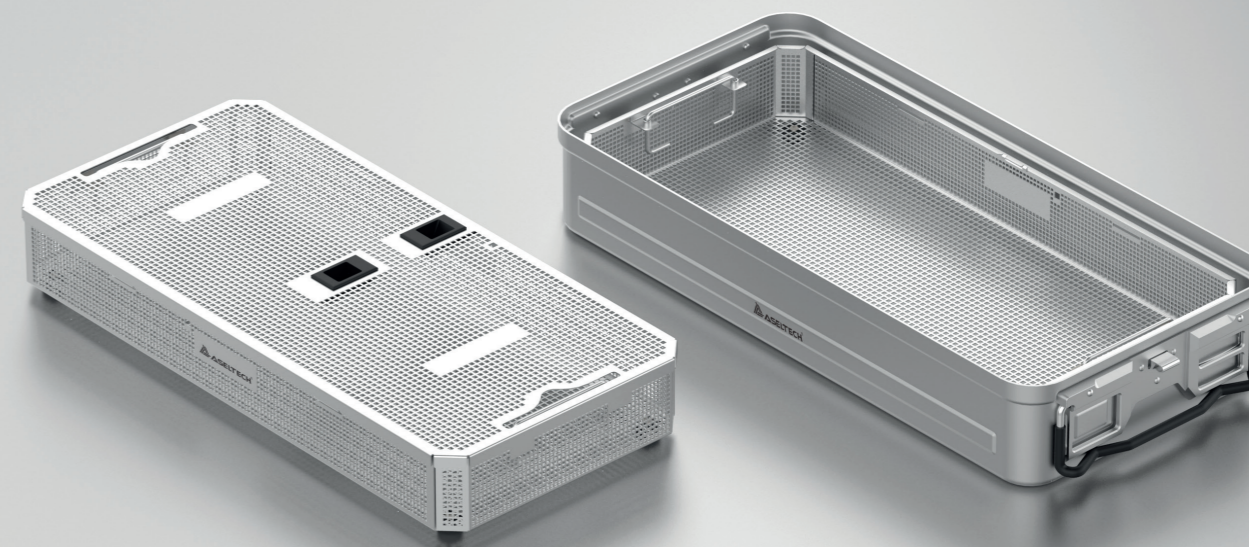
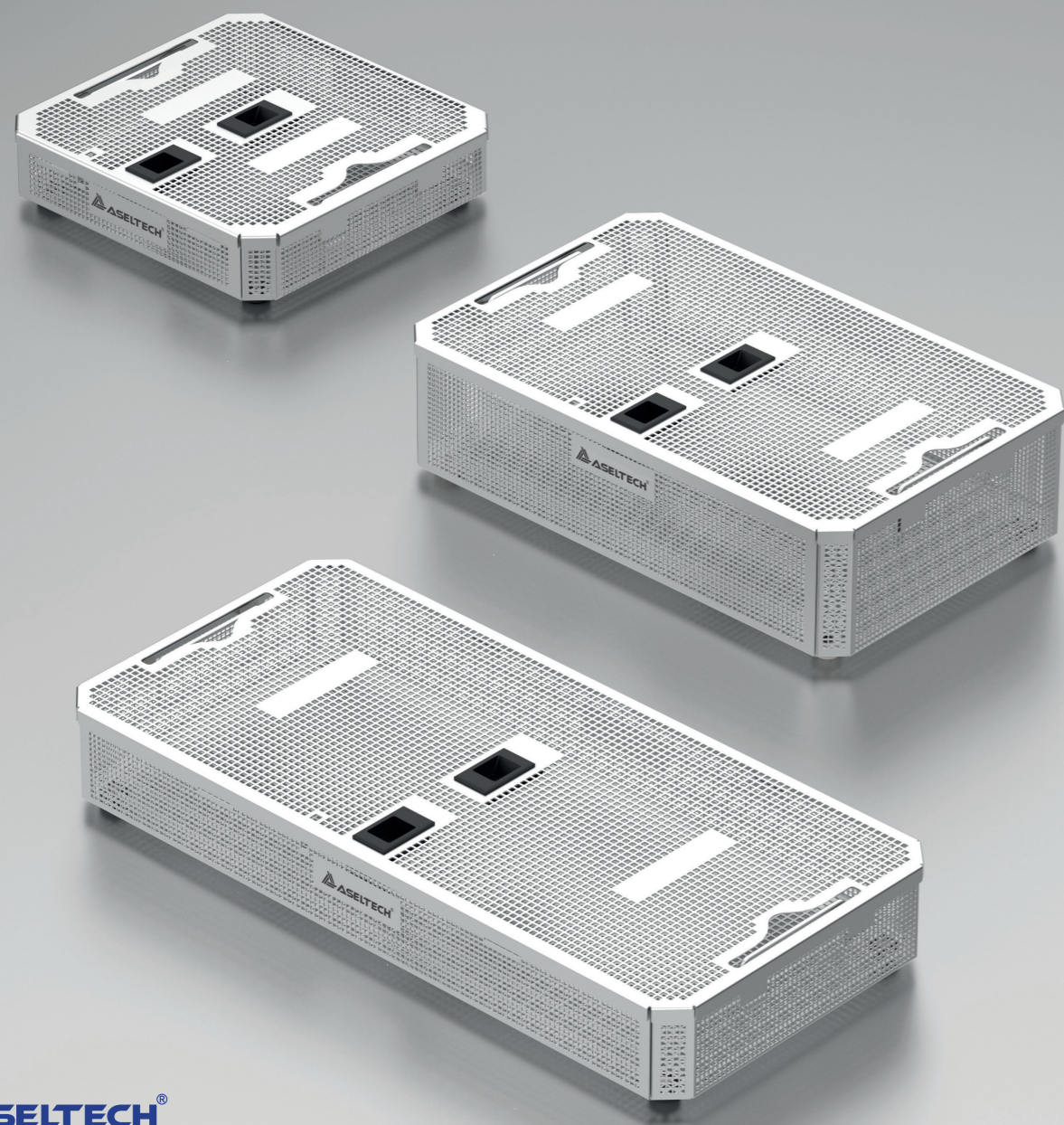

For 1/1 Models

Box
Stand Height: 10 mm



Code	Outside Dimension
CN-3740	540 x 253 x 40 mm
CN-3741	540 x 253 x 60 mm
CN-3742	540 x 253 x 80 mm
CN-3743	540 x 253 x 110 mm

Code	Outside Dimension
CN-3744	485 x 253 x 40 mm
CN-3745	485 x 253 x 60 mm
CN-3746	485 x 253 x 80 mm
CN-3747	485 x 253 x 110 mm

For 1/1 Models

Lid

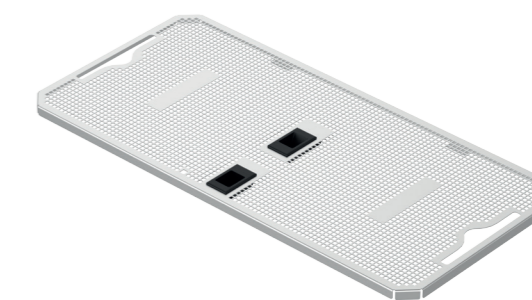
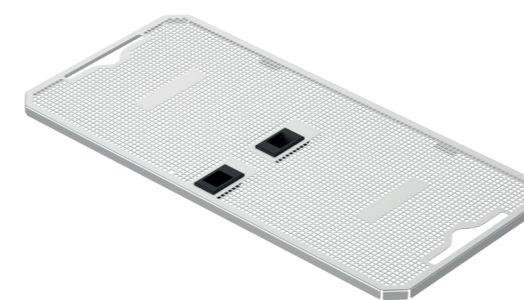

Code	Dimension
CN-3760	542 x 256 x 4 mm

Code	Dimension
CN-3761	487 x 256 x 4 mm



> For 3/4 Models

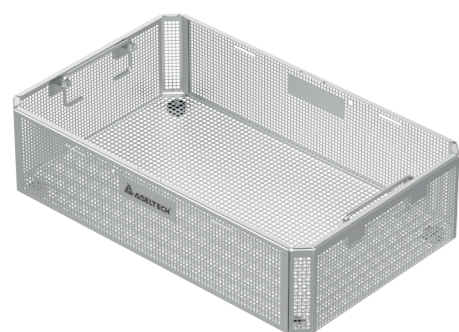

Box
Stand Height: 10 mm

Code	Outside Dimension
CN-3748	405 x 253 x 40 mm
CN-3749	405 x 253 x 60 mm
CN-3750	405 x 253 x 80 mm
CN-3751	405 x 253 x 110 mm

> For 1/2 Models

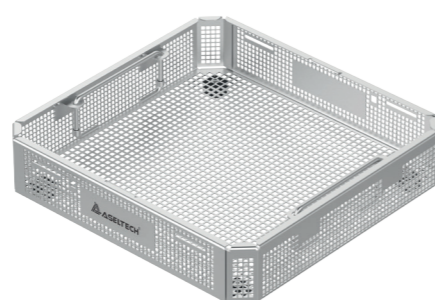

Box
Stand Height: 10 mm

Code	Outside Dimension
CN-3752	244 x 253 x 40 mm
CN-3753	244 x 253 x 60 mm
CN-3754	244 x 253 x 80 mm
CN-3755	244 x 253 x 110 mm

> For 3/4 Models

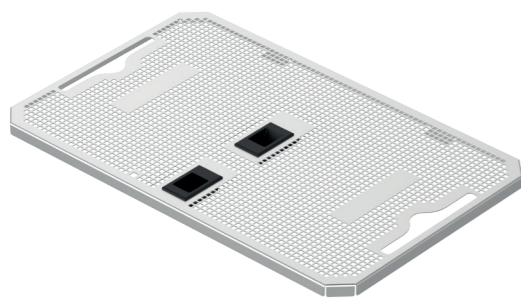

Lid

Code	Outside Dimension
CN-3762	407 x 256 x 4 mm

> For 1/2 Models

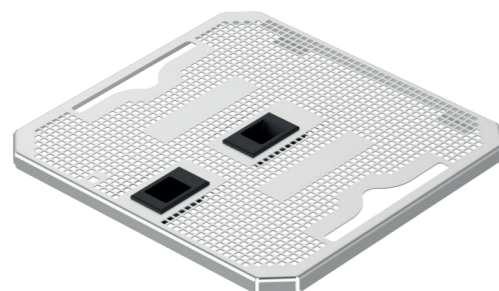

Lid

Code	Outside Dimension
CN-3763	247 x 256 x 4 mm

> For Extra Long Models

Box
Stand Height: 10 mm

Code	Outside Dimension
CN-3711	665 x 253 x 40 mm
CN-3712	665 x 253 x 60 mm
CN-3713	665 x 253 x 80 mm
CN-3714	665 x 253 x 110 mm

> For Extra Long Models

Lid

Code	Outside Dimension
CN-3710	667 x 256 x 4 mm

> For Extra Large Models

Box
Stand Height: 10 mm

Code	Outside Dimension
CN-3705	533 x 340 x 40 mm
CN-3706	533 x 340 x 60 mm
CN-3707	533 x 340 x 80 mm
CN-3708	533 x 340 x 110 mm

> For Extra Large Models

Lid

Code	Outside Dimension
CN-3709	539 x 346 x 4 mm

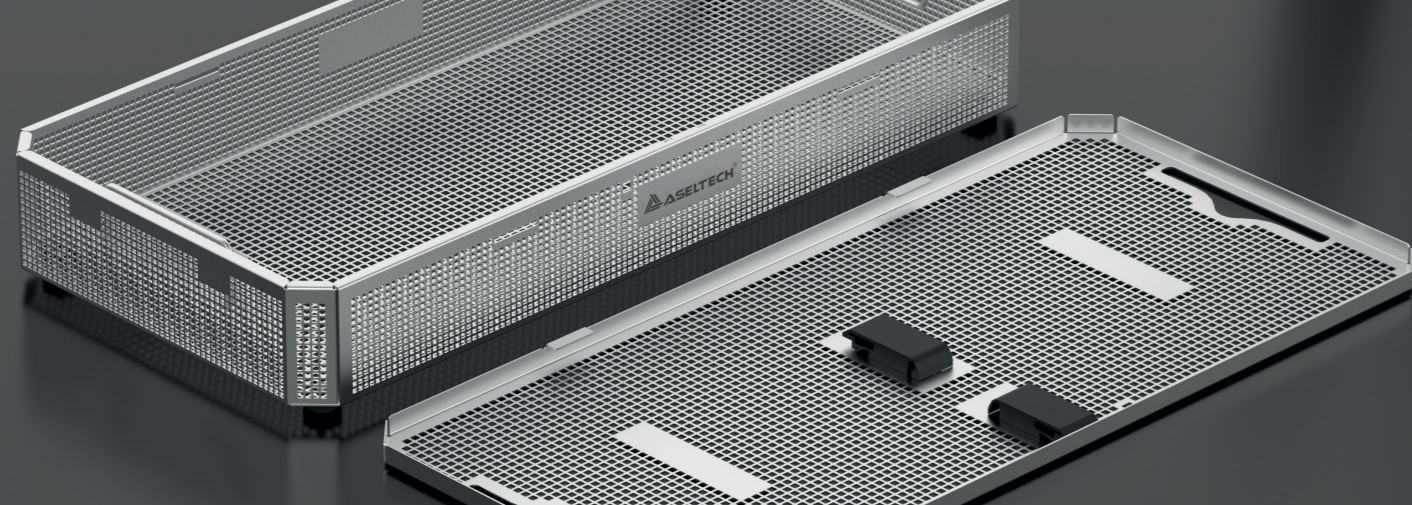

For Large Dental Models

For Dental Models

For Mini Models

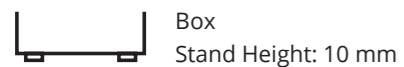

Code	Outside Dimension
CN-3771	320 x 220 x 60 mm
CN-3772	320 x 220 x 80 mm
CN-3773	320 x 220 x 110 mm



Code	Outside Dimension
CN-3774	322 x 223 x 63 mm
CN-3775	322 x 223 x 83 mm
CN-3776	322 x 223 x 113 mm

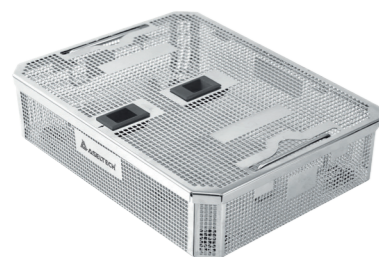

Code	Outside Dimension
CN-3770	322 x 223 x 4 mm

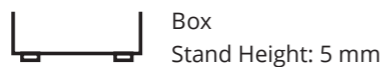

Code	Outside Dimension
CN-3756	275 x 175 x 45 mm
CN-3757	275 x 175 x 105 mm

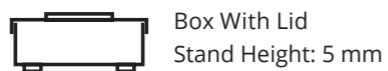

Code	Outside Dimension
CN-3736	277 x 178 x 50 mm
CN-3737	277 x 178 x 110 mm



Code	Outside Dimension
CN-3764	277 x 178 mm

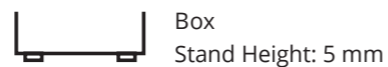

Code	Outside Dimension
CN-3758	265 x 125 x 55 mm

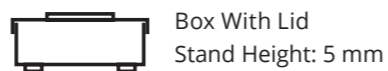

Code	Outside Dimension
CN-3738	267 x 127 x 60 mm



Code	Outside Dimension
CN-3765	267 x 127 mm

STAND >



Code CN-3767 Height 20 mm



Code CN-3768 Height 10 mm



Code CN-3766 Height 5 mm

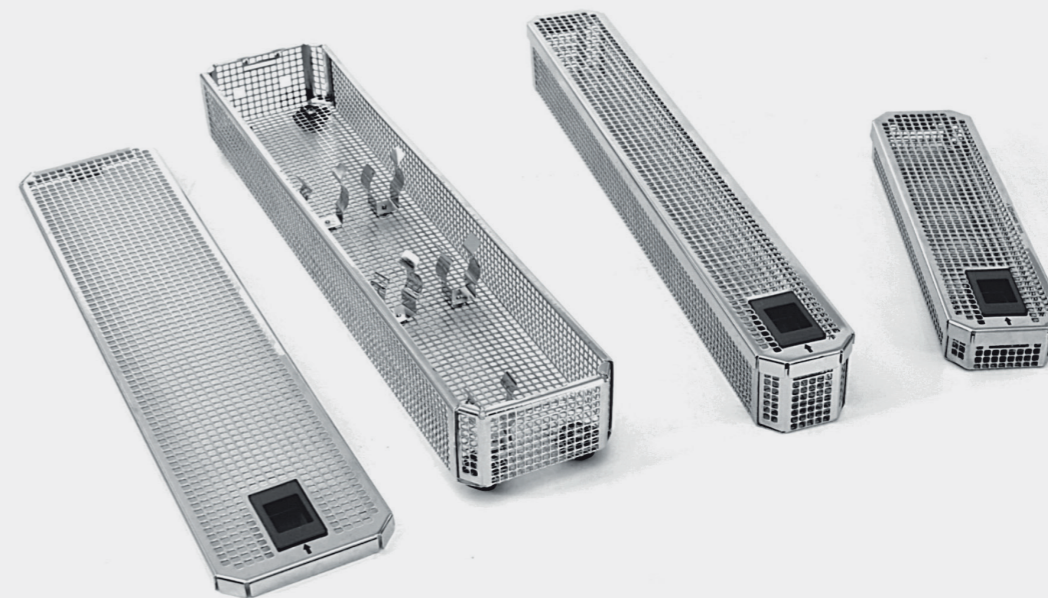

Our wire mesh and perforated sheet baskets can be manufactured in any size.

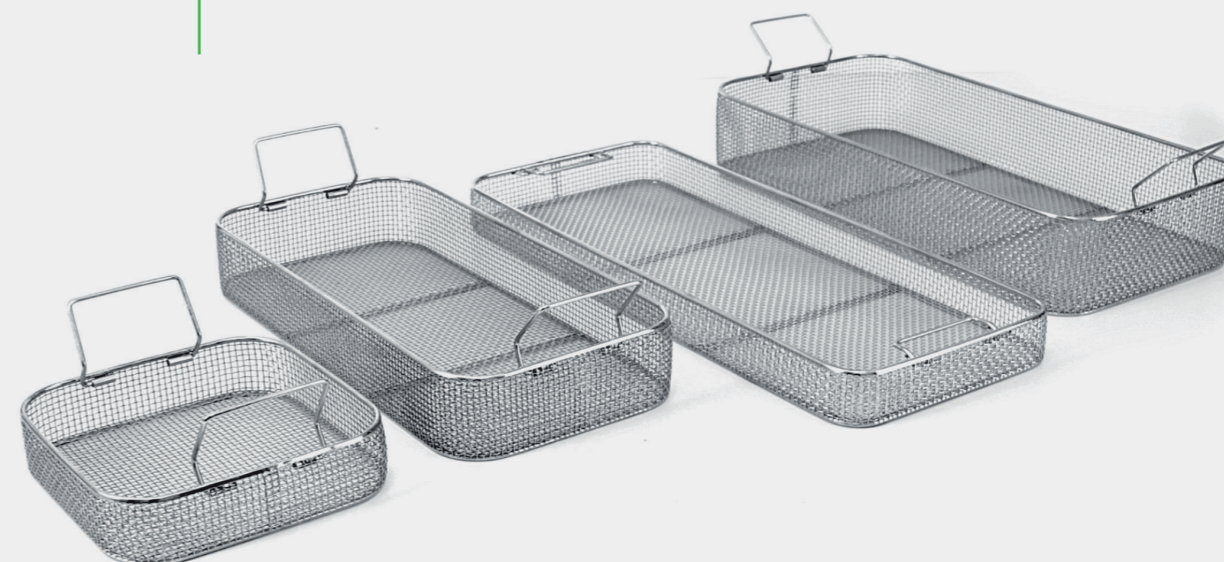

Please contact for detailed information.

BASKETS
STERILE CONTAINER SYSTEMS



Code **Outside Dimension**

CN-3787 138 x 124 x 48 mm

Without silicone fixation systems



Code **Outside Dimension**

CN-3788 146 x 46 x 28 mm

Without silicone fixation systems



Code **Outside Dimension**

CN-3789 86 x 46 x 28 mm

*Without silicone fixation systems
Bottom 2 mm, lid 4 mm perforation*



Code **Outside Dimension**

CN-3780K 274 x 180 x 34 mm

*Basket with silicone fixation systems
Holds 17 instruments with Ø 5 mm*



Code **Outside Dimension**

CN-3780 274 x 180 x 32 mm

Without silicone fixation systems



Code **Outside Dimension**

CN-3786K 191 x 130 x 36 mm

*Basket with silicone fixation systems
Holds 12 instruments with Ø 5 mm*



Code **Outside Dimension**

CN-3786 191 x 130 x 34 mm

Without silicone fixation systems

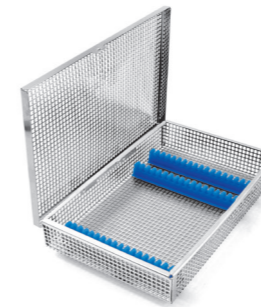

Code **Outside Dimension**

CN-3781K 274 x 180 x 44 mm

*Basket with silicone fixation systems
Holds 17 instruments with Ø 5 mm*



Code **Outside Dimension**

CN-3781 274 x 180 x 42 mm

CN-3782 274 x 180 x 62 mm
Without silicone fixation systems



Code **Outside Dimension**

CN-3790K 186 x 72 x 24 mm

*Tray with silicone fixation system.
Holds 5 instruments.*



Code **Outside Dimension**

CN-3791K 186 x 99 x 24 mm

*Tray with silicone fixation system.
Holds 7 instruments.*



Code **Outside Dimension**

CN-3783K 274 x 88 x 46 mm

*Basket with silicone fixation systems
Holds 8 instruments with Ø 5 mm*



Code **Outside Dimension**

CN-3784K 240 x 76 x 30 mm

Basket with blue silicone mat



Code **Outside Dimension**

CN-3792K 186 x 137 x 24 mm

*Tray with silicone fixation system.
Holds 10 instruments.*



Code **Outside Dimension**

CN-3793K 286 x 192 x 34 mm

*Tray with silicone fixation system.
Holds 20 instruments.*



Code **Outside Dimension**

CN-3785K 188 x 86 x 36 mm

*Basket with silicone fixation systems
Holds 8 instruments with Ø 5 mm*

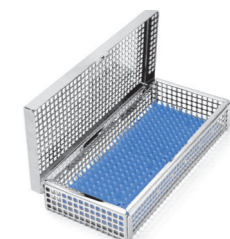

Code **Outside Dimension**

CN-3785 188 x 86 x 32 mm

Basket with blue silicone mat

BASKET MADE FROM
STAINLESS STEEL WIRE MESH



BASKETS
STERILE CONTAINER SYSTEMS

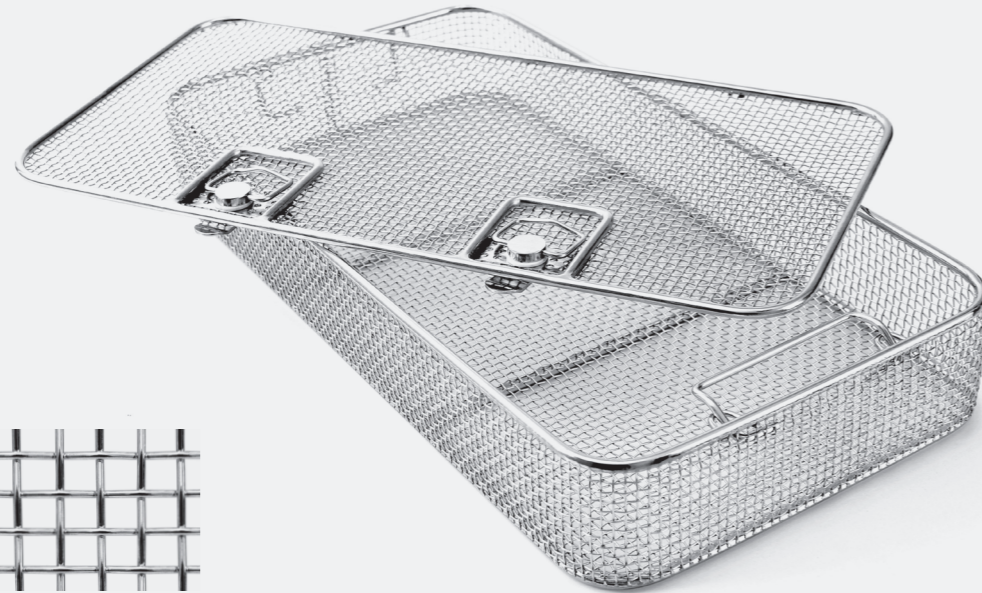

Mesh grid

Actual Size



> For 1/1 Models Box



Code	Outside Dimension
CN-2450	480 x 245 x 30 mm
CN-2451	480 x 245 x 50 mm
CN-2452	480 x 245 x 70 mm
CN-2453	480 x 245 x 100 mm

Lid

Code	Outside Dimension
CN-31024	485 x 245 x 5 mm

> For 1/1 Models Box



Code	Outside Dimension
CN-2460	540 x 245 x 30 mm
CN-2461	540 x 245 x 50 mm
CN-2462	540 x 245 x 70 mm
CN-2463	540 x 245 x 100 mm

Lid

Code	Outside Dimension
CN-31014	540 x 245 x 5 mm

> For 1/2 Models Box



Code	Outside Dimension
CN-2490	246 x 246 x 30 mm
CN-2491	246 x 246 x 50 mm
CN-2492	246 x 246 x 70 mm
CN-2493	246 x 246 x 100 mm

Lid

Code	Outside Dimension
CN-31045	246 x 246 mm

> For 3/4 Models Box



Code	Outside Dimension
CN-21500	405 x 245 x 30 mm
CN-21501	405 x 245 x 50 mm
CN-21502	405 x 245 x 70 mm
CN-21503	405 x 245 x 100 mm

Lid

Code	Outside Dimension
CN-31034	405 x 245 mm

> For Large Dental Models Box



Code	Outside Dimension
CN-32000	323 x 222 x 50 mm
CN-32001	323 x 222 x 70 mm
CN-32002	323 x 222 x 100 mm

Lid

Code	Outside Dimension
CN-32013	323 x 222 x 5 mm

> For Extra Large Models Box

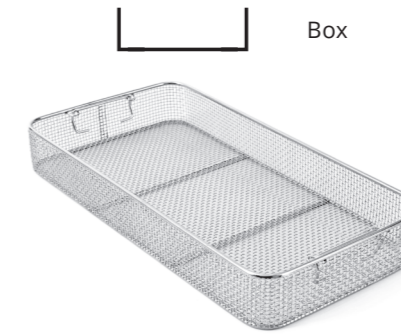

Code	Outside Dimension
CN-21701	533 x 337 x 50 mm
CN-21702	533 x 337 x 70 mm
CN-21703	533 x 337 x 100 mm

Lid

Code	Outside Dimension
CN-31707	533 x 337 x 5 mm

> For Extra Long Models Box

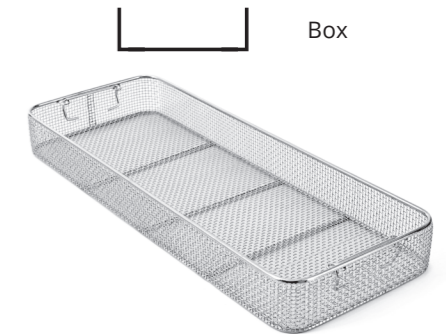

Code	Outside Dimension
CN-21801	665 x 250 x 50 mm
CN-21802	665 x 250 x 70 mm
CN-21803	665 x 250 x 100 mm

Lid

Code	Outside Dimension
CN-31807	665 x 250 x 5 mm

BASKET MADE FROM
STAINLESS STEEL WIRE MESH

SMALL FINE MESH BASKETS WITH LID
WIRE BASE

BASKETS

STERILE CONTAINER SYSTEMS

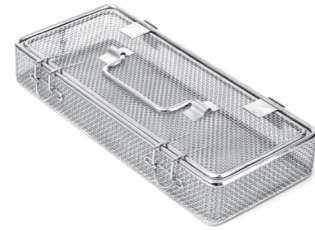
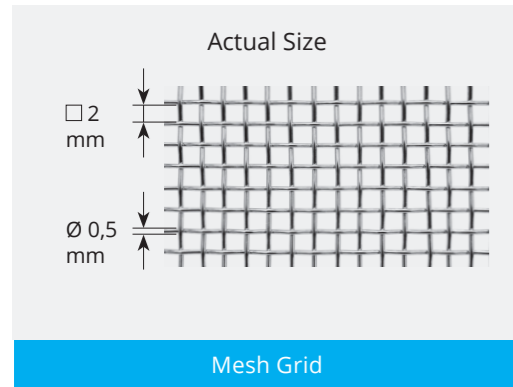

Code	Outside Dimension
CN-2993	268 x 127 x 47 mm



Code	Outside Dimension
CN-31073	268 x 117 x 43 mm

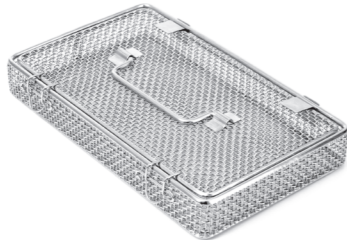
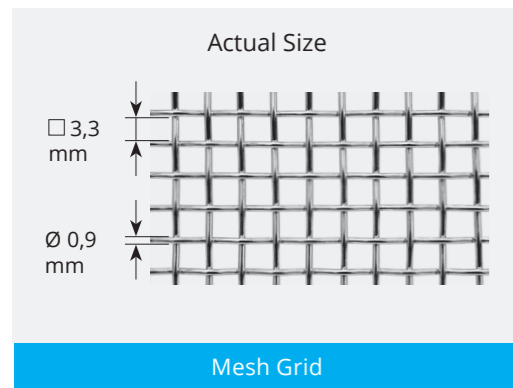
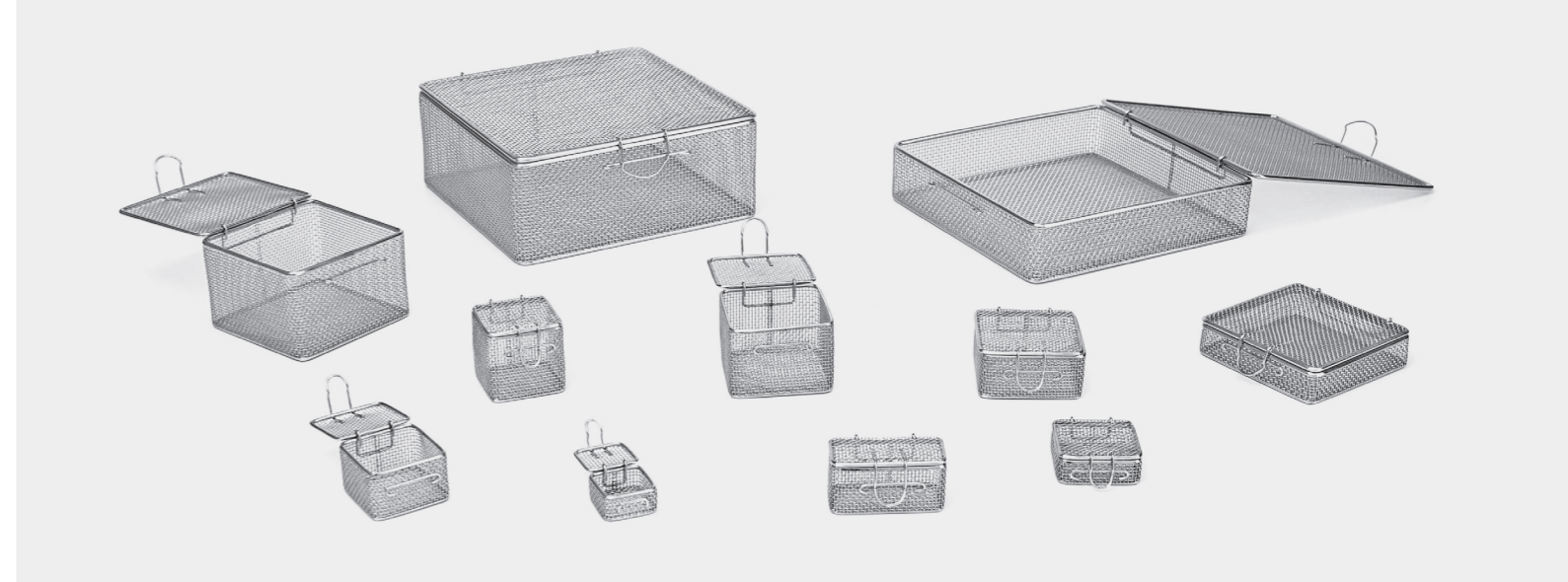

Code	Outside Dimension
CN-3611	270 x 175 x 45 mm



Code	Outside Dimension
CN-31070	270 x 170 x 38 mm

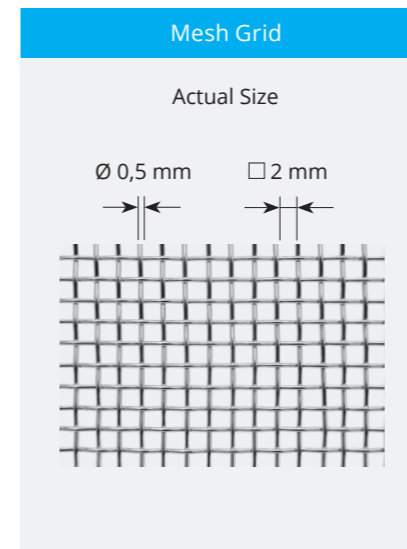

Code	Outside Dimension
CN-31100	30 x 30 x 30 mm
CN-31101	40 x 40 x 20 mm
CN-31102	40 x 40 x 40 mm
CN-31103	60 x 60 x 20 mm
CN-31104	60 x 60 x 40 mm
CN-31105	60 x 60 x 60 mm
CN-31106	80 x 80 x 20 mm
CN-31107	80 x 40 x 40 mm
CN-31108	80 x 80 x 40 mm



Code	Outside Dimension
CN-31109	80 x 80 x 60 mm
CN-31110	80 x 80 x 80 mm
CN-31111	100 x 100 x 10 mm
CN-31112	120 x 120 x 30 mm
CN-31113	120 x 120 x 60 mm
CN-31114	120 x 120 x 80 mm
CN-31115	240 x 240 x 30 mm
CN-31116	240 x 240 x 60 mm
CN-31117	240 x 240 x 80 mm
CN-31118	240 x 240 x 100 mm

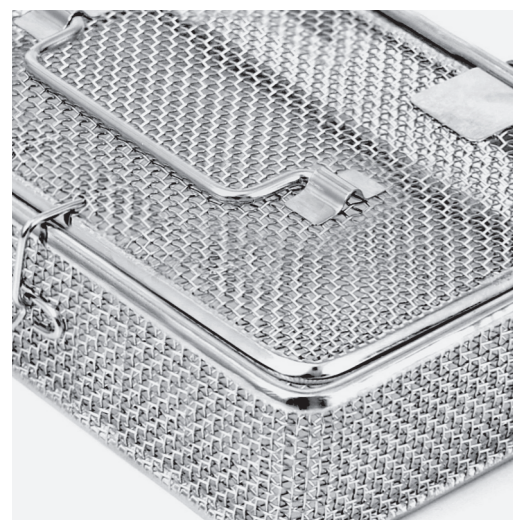

Code	Outside Dimension
CN-2995	175 x 153 x 45 mm



Code	Outside Dimension
CN-31079	175 x 144 x 40 mm

WIRE BASE

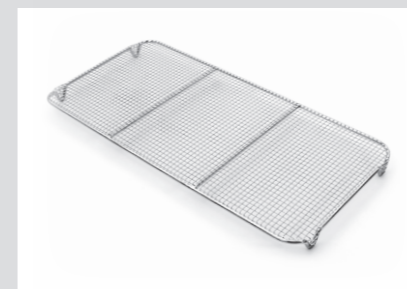

Code	Outside Dimension
CN-2440	545 x 255 x 30 mm



Code	Outside Dimension
CN-21522	405 x 255 x 30 mm



Code	Outside Dimension
CN-2482	255 x 255 x 30 mm

BASKETS

STERILE CONTAINER SYSTEMS

BASKETS

STERILE CONTAINER SYSTEMS

> **LAUNDRY BASKETS**

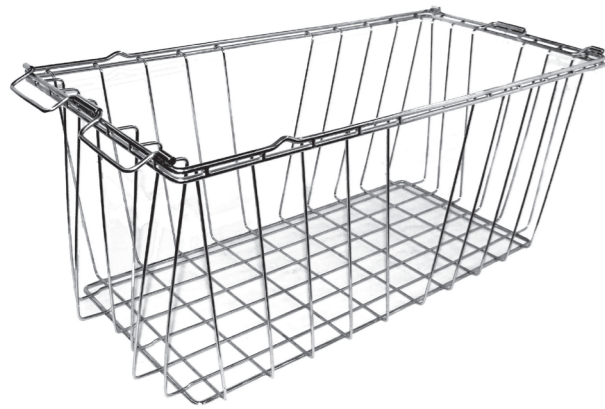

Code	Outside Dimension
------	-------------------

CN-31080	600 x 400 x 150 mm
CN-31081	600 x 400 x 300 mm

Code	Outside Dimension
------	-------------------

CN-31085	600 x 400 x 150 mm
CN-31086	600 x 400 x 300 mm

> **STE BASKETS**

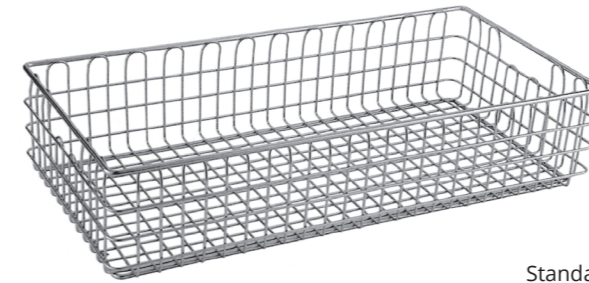

Standard

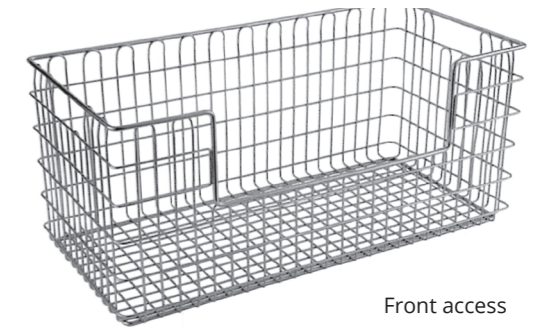

Front access

Code	Outside Dimension
------	-------------------

CN-31206	575 x 280 x 135 mm
CN-31207	575 x 280 x 265 mm

Code	Outside Dimension
------	-------------------

CN-31208	575 x 280 x 265 mm
----------	--------------------

> **WIRE NET BASKETS**

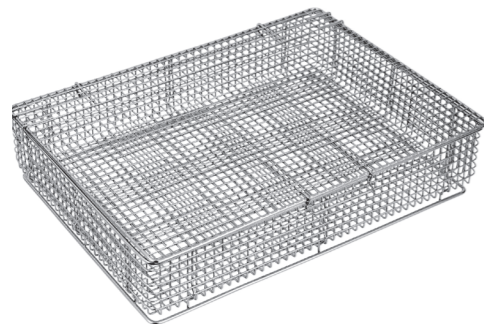

Code	Outside Dimension
------	-------------------

CN-31200	250 x 170 x 70 mm
CN-31201	340 x 250 x 70 mm
CN-31202	450 x 340 x 70 mm

> **LID FOR WIRE NET BASKETS**

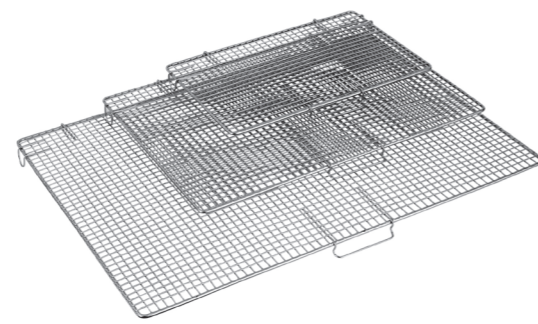

Code	Outside Dimension
------	-------------------

CN-31203	250 x 170 mm
CN-31204	340 x 250 mm
CN-31205	450 x 340 mm

> **SPRI BASKETS**



Double Frame with Folding Handle

Code	Outside Dimension
------	-------------------

CN-31210	585 x 395 x 100 mm
CN-31211	585 x 395 x 195 mm

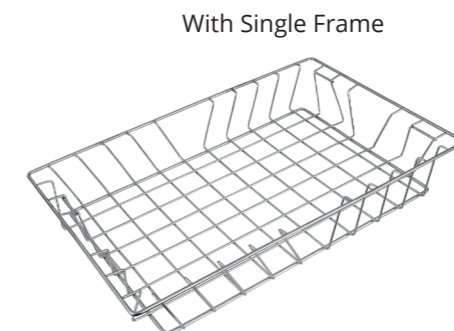

With Single Frame

Code	Outside Dimension
------	-------------------

CN-31230	600 x 300 x 40 mm
CN-31231	600 x 300 x 50 mm
CN-31232	600 x 300 x 100 mm
CN-31233	600 x 300 x 130 mm
CN-31234	600 x 300 x 150 mm
CN-31235	600 x 300 x 180 mm
CN-31236	600 x 300 x 200 mm
CN-31237	600 x 400 x 100 mm
CN-31238	600 x 400 x 130 mm
CN-31239	600 x 400 x 150 mm
CN-31240	600 x 400 x 180 mm
CN-31241	600 x 400 x 200 mm

BASKETS
STERILE CONTAINER SYSTEMS

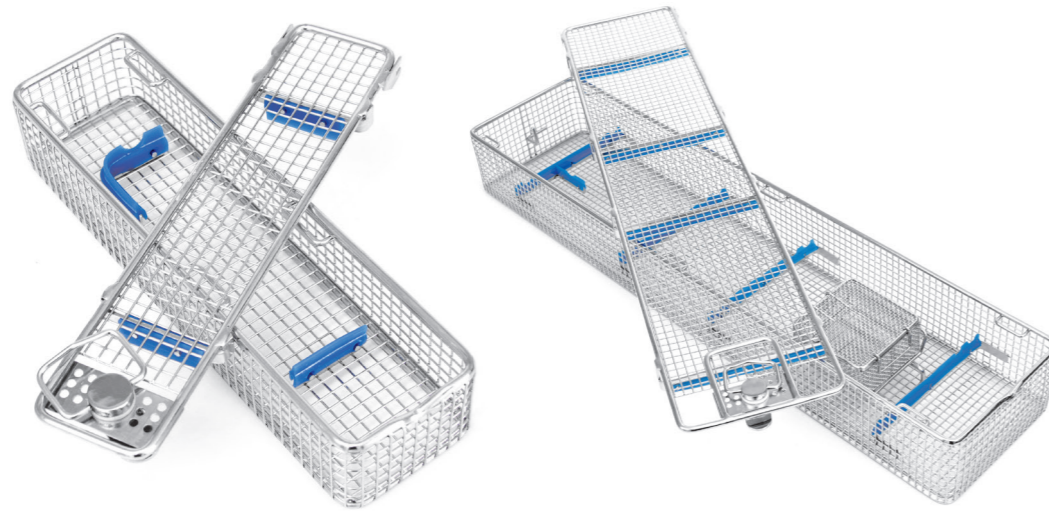

Code	Outside Dimension
CN-31119	245 x 130 x 55 mm



Code	Outside Dimension
CN-31120	245 x 130 x 70 mm



304 ss wire mesh

Actual Size

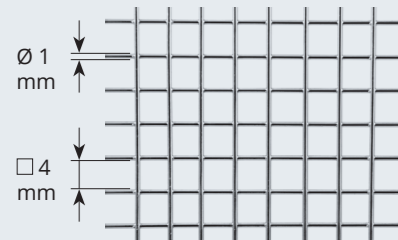

Code	Outside Dimension
CN-31050	670 x 80 x 52 mm
CN-31051	460 x 80 x 52 mm
CN-31052	290 x 80 x 52 mm

Code	Outside Dimension
CN-31062	640 x 150 x 77 mm

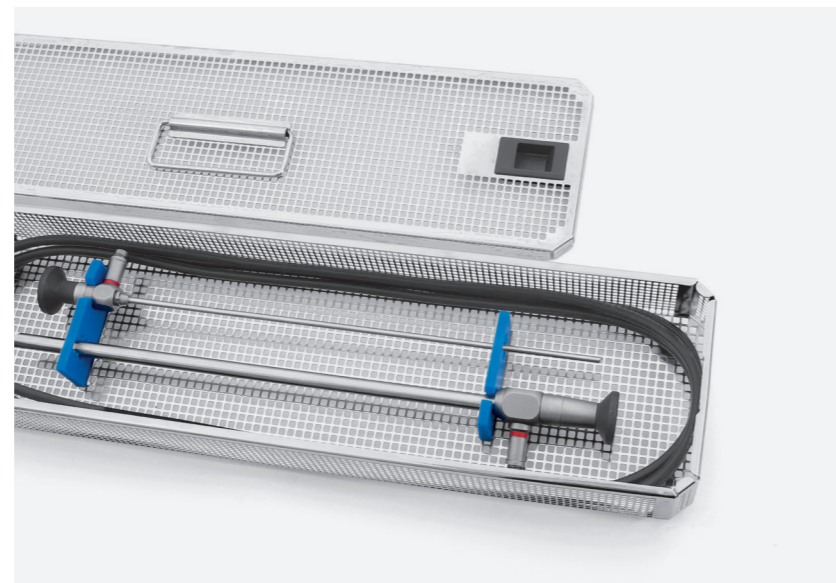
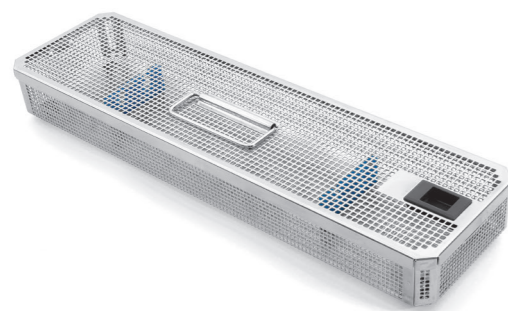

Code	Outside Dimension
CN-31054	492 x 134 x 55 mm
CN-31055	492 x 134 x 65 mm



Code	Outside Dimension
CN-31121	245 x 130 x 105 mm



BASKETS

STERILE CONTAINER SYSTEMS

WASHER TUBE FOR K-WIRES

The Aseltech washer tube systems are designed in order to safely keep, healthfully wash and sterile the K-Wires used especially in orthopedic (trauma) surgery.



WASHER TUBE FOR K-WIRES

The Aseltech washer tube systems are designed in order to safely keep, healthfully wash and sterile the K-Wires used especially in orthopedic (trauma) surgery. The Aseltech washer tubes systems have a special design for getting maximum efficiency. The dividing part inside the tube provides protection of 4 different diameter wires without intermixing. With the help of inner tube placed in the middle of the divider, the high pressure water coming of the washer machine flows from inside to outside. By this way, the wires inside the tube are washed by inside-out and outside-in flow and the disinfection process is completed efficiently.

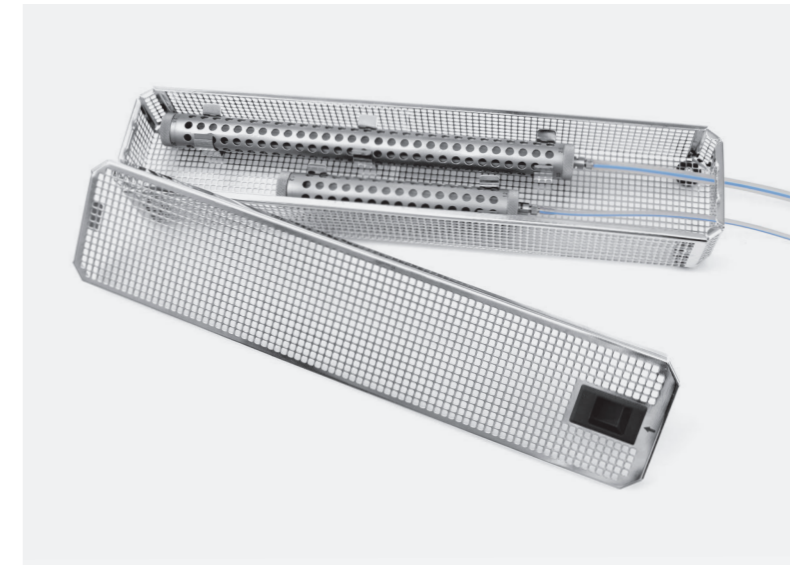

- The system has 2 different lengths as option.
- Every tube has 4 different tanks for 4 different diameter wires.
- The system has been designed suitable for 12 different diameter from 0,6 mm to 3 mm.

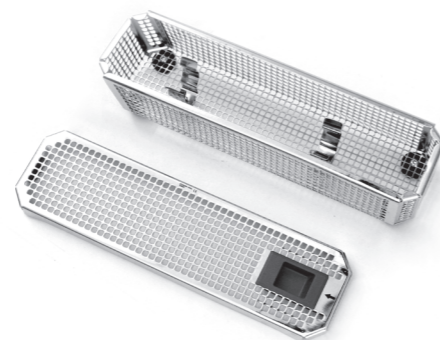

Code Outside Dimension

CN-41051 460 x 100 x 64 mm

K-Wires stainless steel basket with lid.

Code Outside Dimension

CN-41052 265 x 72 x 64 mm

K-Wires stainless steel basket with lid.

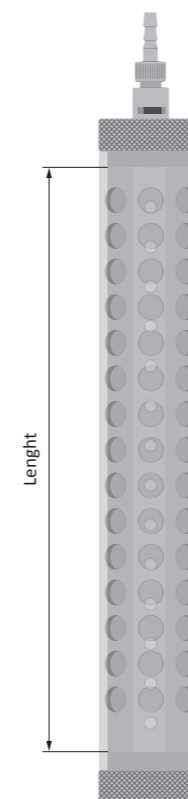

Code	Length	Suitable Wire Diameters
CN-KA100	150 mm	Ø 0,60 mm Ø 0,80 mm Ø 1,00 mm Ø 1,20 mm
CN-KB100	150 mm	Ø 1,25 mm Ø 1,40 mm Ø 1,50 mm Ø 1,60 mm
CN-KC100	150 mm	Ø 1,80 mm Ø 2,00 mm Ø 2,50 mm Ø 3,00 mm
CN-LA100	300 mm	Ø 0,60 mm Ø 0,80 mm Ø 1,00 mm Ø 1,20 mm
CN-LB100	300 mm	Ø 1,25 mm Ø 1,40 mm Ø 1,50 mm Ø 1,60 mm
CN-LC100	300 mm	Ø 1,80 mm Ø 2,00 mm Ø 2,50 mm Ø 3,00 mm

All rights reserved.No part of this catalog
may be reproduced in any form without the
written permission from ASELTECH

CENTRAL FACTORY

- > Köprübaşı Mahallesi Selanik Caddesi No:255
Tekkeköy/Samsun/Turkey
- > T : +90 362 266 59 29
F : +90 362 266 59 39
- > info@aseltch.com.tr



www.aseltch.com.tr